

YASARGIL[®] Aneurysm Clip System

Rx Only

The most trusted name in Aneurysm treatment for over 45 years



Aesculap Neurosurgery

AESCULAP[®]

YASARGIL® Aneurysm Clip System



1968

- The first generation YASARGIL Aneurysm Clips were made from steel with a half spring coil and no jaw guidance.



1970

- The YASARGIL Aneurysm Clip with 1.5 spring coil and safety ring were introduced to enhance closing force and stability.



1983

- The YASARGIL Aneurysm Clip made from Phynox increases MRI compatibility. A patented box lock improves the characteristics with regard to alleviating the "scissoring" effect.

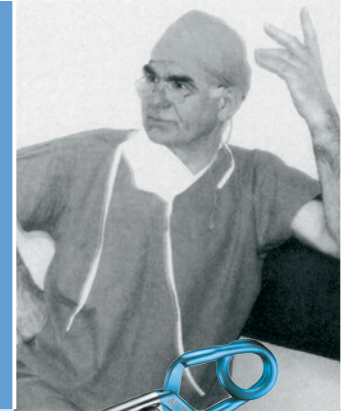

1995

- The YASARGIL Aneurysm Clip with 1.5 spring coil made from titanium improves postoperative control and diagnosis by reducing the number of artifacts in CT and MRI scans.

The "Gold Standard" for Aneurysm treatment

How can a surgeon be sure that the instruments he is using for lifesaving aneurysm surgery deserve the trust his patients place in him?

The evidence is based in the development of the clip design by Prof. Gazi M. Yasargil.

Decades of intensive cooperation with other leading neurosurgeons all over the world form the foundation for Aesculap's technical and scientific experience.

Since their introduction, over 2 million clips have been implanted by thousands of neurosurgeons in more than 80 countries. A milestone in the history of neurosurgery.

The surgical treatment of cerebral aneurysms will continue to represent an important and indispensable therapy option into the future.

Through further innovation and development of the YASARGIL Aneurysm Clip system, Aesculap will continue to offer implants and instruments of high quality for our customers and their patients.

Indications for Use:

The Yasargil Aneurysm clips are intended for occlusion of cerebral aneurysms in either a temporary or permanent manner. They are applied with Aesculap clip applicators, which contain titanium alloy or phynox jaws.

See Instructions for Use for additional information including Warnings and Precautions.

Rx Only.

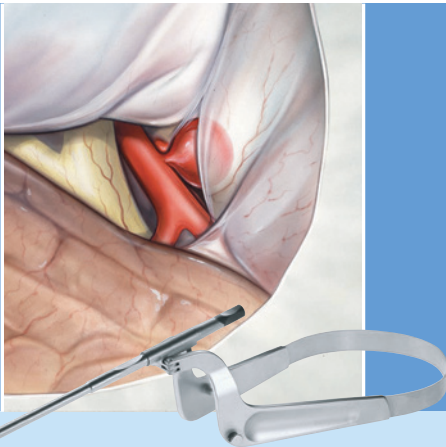

2004

- The XS Clip Applier was introduced to support keyhole surgery.

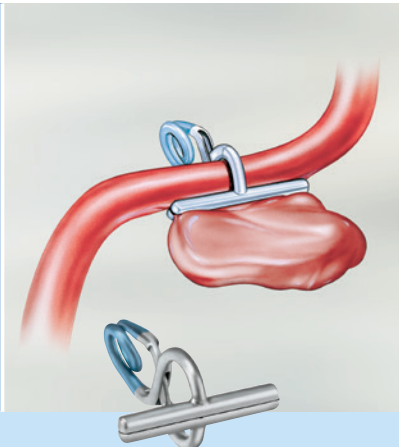

2006

- The YASARGIL Aneurysm T-Bar and AVM Clips made from titanium and Phynox aid and expand treatment possibilities.



2013

- The first Mini clips with fenestration allow for a more precise reconstruction of the vascular structures in narrow spaces.

■ Quality Leader

Manufactured in Aesculap's state-of-the-art production facility in Tuttlingen, Germany to ensure Aesculap quality standards.

■ Trusted Experience

Since their introduction in 1968, over 2 million YASARGIL Aneurysm Clips have been implanted worldwide.

■ Education Commitment

The Aesculap Academy® provides professional development and training courses in over 40 countries, with a world-wide reputation as a leading forum for medical training.

■ Excellent Performance

Strong clinical outcomes make YASARGIL Aneurysm Clips the #1 choice of cerebrovascular neurosurgeons worldwide.



YASARGIL[®] Aneurysm Clip System

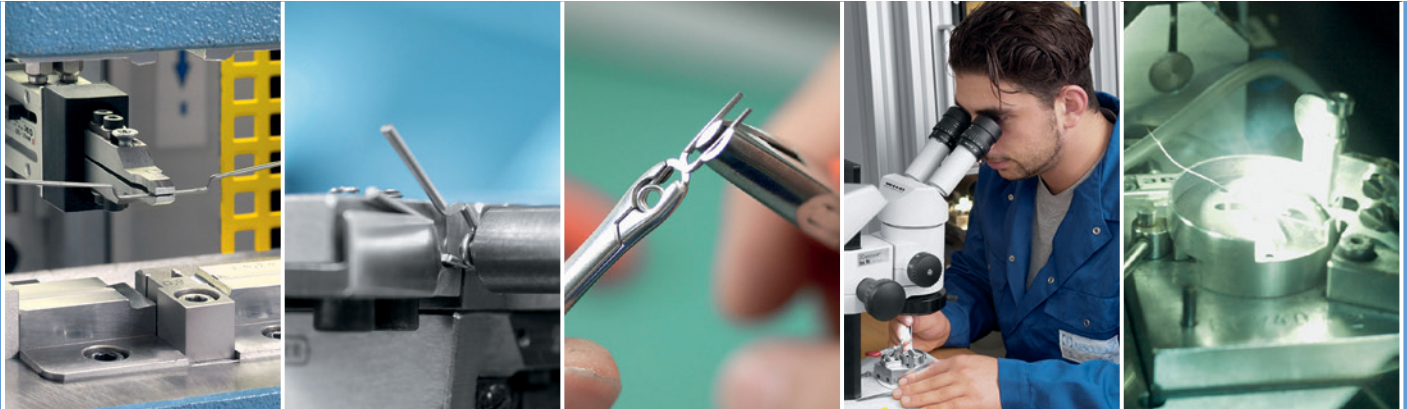

• A simple piece of wire...

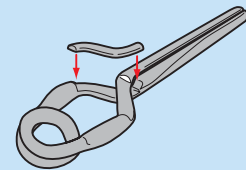
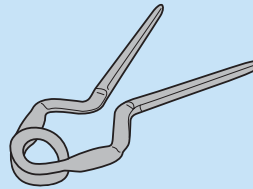
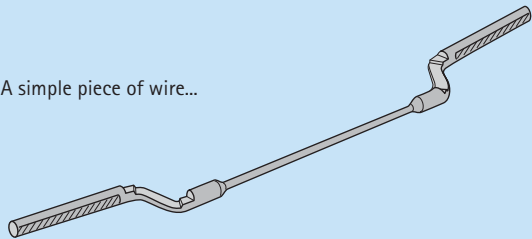

Quality you can trust

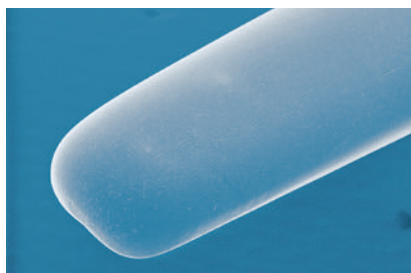

REM image
Atraumatic tip of a YASARGIL Clip from Aesculap
Smooth surface prevents damage to tissue.

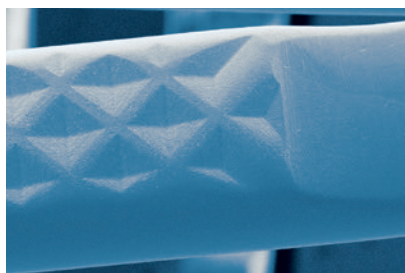

REM image
Atraumatic blade profile of a YASARGIL Clip from Aesculap
The deep, symmetrical, pyramidal stamping of both blades doubles the contact surface area and counteracts the slip effect.



REM image
Unique box lock of a YASARGIL Clip from Aesculap
The flat design with a broad contact surface enables smooth opening and closing as well as stability.

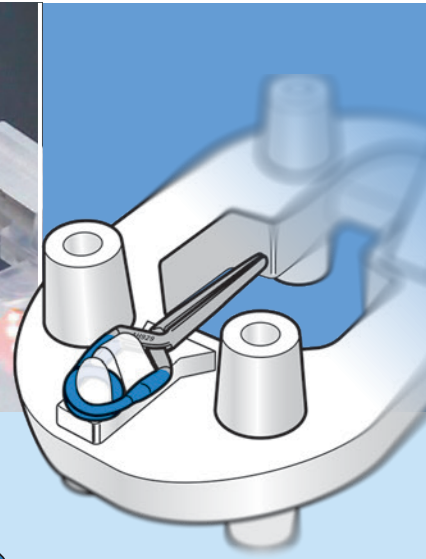

• ... becomes a critical tool for advanced treatment of aneurysms.

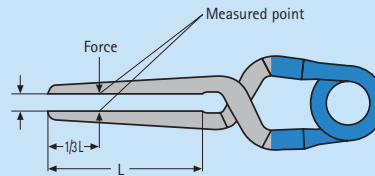
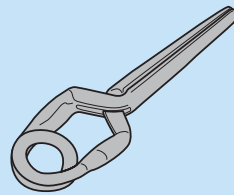

DID YOU KNOW?

- 30 production steps are required to produce one clip.
- 70% of the production is performed manually under the microscope.
- A clip is checked 10 times for dimension, surface and closing force during the production process.
- The profile of the blades are stamped evenly with 24 tons.
- The manufacturing tolerances of 0.02 mm are 10 times smaller than a human hair.
- The welding temperature for the metal plate reaches 2500 °C (4532 °F).
- The serial no. allows for traceability back to every clip individually.

YASARGIL® Aneurysm Clip System

Titanium Standard Clips

TITANIUM STANDARD

TEMPORARY						PERMANENT					
Item No.		Blade length	Maximal opening	Closing force		Item No.		Blade length	Maximal opening	Closing force	
		mm	mm	N	g			mm	mm	N	g
FT240T		7.0	6.2	1.08	110	FT740T		7.0	6.2	1.47	150
FT250T		9.0	7.0	0.88	90	FT750T		9.0	7.0	1.77	180
FT260T		11.0	7.8	0.88	90	FT760T		11.0	7.8	1.77	180
FT280T		15.0	9.2	0.88	90	FT780D		15.0	9.2	1.96	200
FT292T		17.5	10.6	0.88	90	FT792D		17.5	10.6	1.96	200
FT290T		20.0	11.4	1.08	110	FT790D		20.0	11.4	1.96	200
FT242T		6.5	6.0	1.08	110	FT742T		6.5	6.0	1.47	150
FT252T		8.3	6.8	0.88	90	FT752T		8.3	6.8	1.77	180
FT262T		10.2	7.5	0.88	90	FT762T		10.2	7.5	1.77	180
FT282T		13.7	8.7	1.08	110	FT782T		13.7	8.7	1.96	200
FT286T		15.3	9.8	1.08	110	FT786T		15.3	9.8	1.77	180
FT244T		5.4	5.5	1.08	110	FT744T		5.4	5.5	1.47	150
FT254T		6.4	6.1	1.08	110	FT754T		6.4	6.1	1.77	180

TEMPORARY

PERMANENT

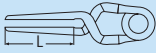
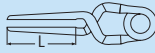
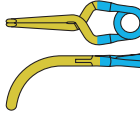
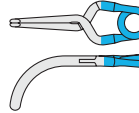
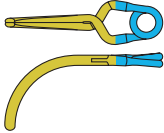
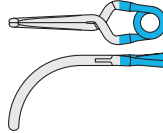
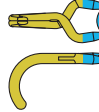
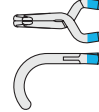
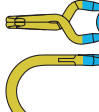
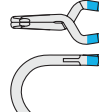
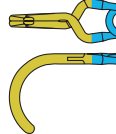
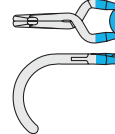
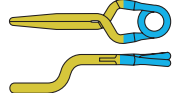
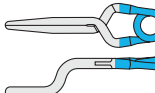
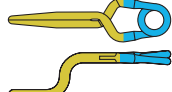
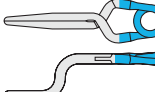
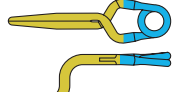
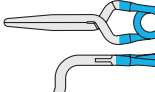
Item No.		Blade length		Maximal opening		Closing force		Item No.		Blade length		Maximal opening		Closing force	
		mm	mm	mm	mm	N	g			mm	mm	N	g		
FT264T		8.0	6.5	1.08	110	FT764T		8.0	6.5	1.77	180				
FT284T		10.3	7.4	1.08	110	FT784T		10.3	7.4	1.96	200				
FT323T		7.4	5.4	1.08	110	FT823T		7.4	5.4	1.77	180				
FT324T		8.4	5.8	1.08	110	FT824T		8.4	5.8	1.77	180				
FT325T		10.5	6.2	1.08	110	FT825T		10.5	6.2	1.77	180				
FT270T		5.0	8.0	1.08	110	FT770T		5.0	8.0	1.96	200				
FT271T		5.0	8.0	1.08	110	FT771T		5.0	8.0	1.96	200				
FT272T		5.0	8.0	1.08	110	FT772T		5.0	8.0	1.96	200				

■ MR Conditional, 3-Tesla or less*

■ Color coding with blue spring (Standard clip) and golden or silver blades (temporary or permanent clip respectively)

■ Sterile packaging

* Please refer to the MRI Safety Information section of the Instructions for Use for MR-related safety information.

YASARGIL® Aneurysm Clip System







Titanium Standard Clips

TITANIUM STANDARD

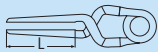
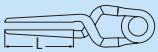
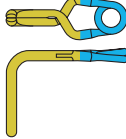
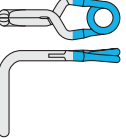
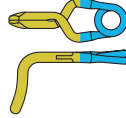
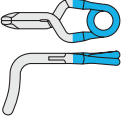
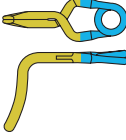
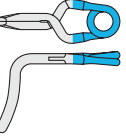
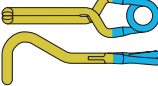
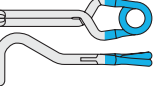
TEMPORARY						PERMANENT									
Item No.		Blade length		Maximal opening		Closing force		Item No.		Blade length		Maximal opening		Closing force	
		mm		mm		N	g			mm		mm		N	g
FT248T		7.0		7.9		0.88	90	FT748T		7.0		7.9		1.96	200
FT258T		9.0		8.7		0.88	90	FT758T		9.0		8.7		1.96	200
FT259T		12.0		10.2		0.88	90	FT759T		12.0		10.2		1.96	200
FT103T		6.1		6.5		1.08	110	FT603T		6.1		6.5		1.96	200
FT113T		8.0		6.2		1.08	110	FT613T		8.0		6.2		1.96	200
FT310T		9.0		6.5		1.08	110	FT810T		9.0		6.5		1.96	200
FT123T		10.6		7.8		1.08	110	FT623T		10.6		7.8		1.96	200
FT263T		11.8		8.4		1.08	110	FT763T		11.8		8.4		1.67	170
FT319T		5.0		5.6		1.28	130	FT819T		5.0		5.6		1.96	200
FT320T		7.0		4.5		1.28	130	FT820T		7.0		4.5		1.96	200

TEMPORARY

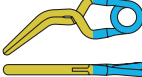
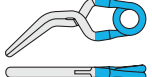
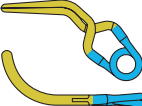
PERMANENT

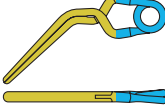
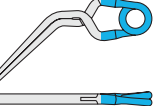
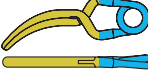
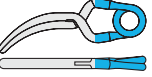
Item No.		Blade length	Maximal opening	Closing force		Item No.		Blade length	Maximal opening	Closing force	
				mm	mm					N	g
FT322T		10.0	5.6	1.28	130	FT822T		10.0	5.6	1.96	200
FT350T		6.7	5.4	1.28	130	FT850T		6.7	5.4	1.96	200
FT351T		9.0	5.6	1.28	130	FT851T		9.0	5.6	1.96	200
FT330T		7.0	7.2	0.88	90	FT830T		7.0	7.2	1.96	200
FT332T		9.3	7.2	0.88	90	FT832T		9.3	7.2	1.96	200
FT333T		11.3	8.2	0.88	90	FT833T		11.3	8.2	1.96	200
FT246T		7.0	5.7	0.88	90	FT746T		7.0	5.7	1.96	200
FT273T		7.8	5.3	0.88	90	FT773T		7.8	5.5	1.77	180
FT261T		11.4	8.0	0.88	90	FT761T		11.4	8.0	1.96	200
FT247T		8.6	7.0	0.88	90	FT747T		8.6	7.0	1.77	180

■ MR Conditional, 3-Tesla or less*

■ Color coding with blue spring (Standard clip) and golden or silver blades (temporary or permanent clip respectively)







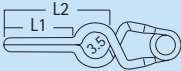
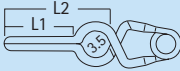
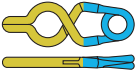
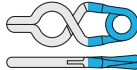

■ Sterile packaging

* Please refer to the MRI Safety Information section of the Instructions for Use for MR-related safety information.

YASARGIL® Aneurysm Clip System

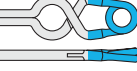

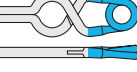

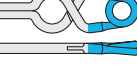
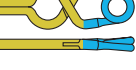
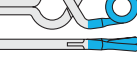
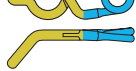
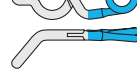
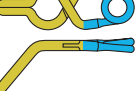
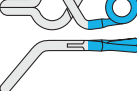
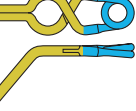
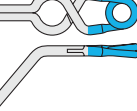
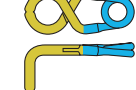
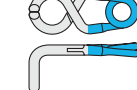
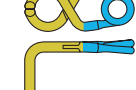
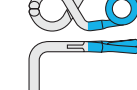





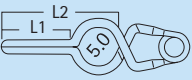

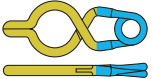
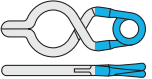
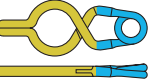
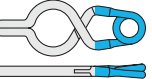
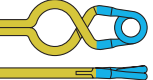
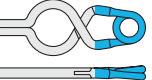
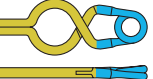
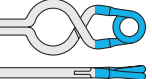
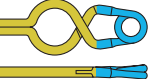
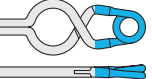
Titanium Standard Clips with Fenestration

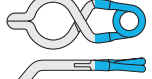
TITANIUM STANDARD

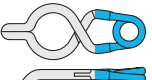
TEMPORARY						PERMANENT					
Item No.		Diameter of fenestration 3.5 mm				Item No.		Diameter of fenestration 3.5 mm			
		Blade length mm L1/L2	Maximal opening mm	Closing force N g				Blade length mm L1/L2	Maximal opening mm	Closing force N g	
FT097T		3/8.1	7.5	1.08	110	FT597T		3/8.1	7.5	1.47	150
FT098T		4/9.1	7.4	1.08	110	FT598T		4/9.1	7.4	1.47	150
FT099T		5/10.1	7.4	1.08	110	FT599T		5/10.1	7.4	1.47	150
FT100T		6/11.1	7.4	1.08	110	FT600T		6/11.1	7.4	1.47	150
FT110T		9/14.1	8.4	1.08	110	FT610T		9/14.1	8.4	1.47	150
FT120T		12/17	9.6	1.08	110	FT620T		12/17	9.6	1.77	180
FT102T		5/7.8	5.8	1.08	110	FT602T		5/7.8	5.8	1.47	150
FT112T		7.5/9.4	6.5	1.08	110	FT612T		7.5/9.4	6.5	1.47	150
FT122T		10/11	7.2	1.08	110	FT622T		10/11	7.2	1.77	180
FT104T		5/5.1	4.9	1.08	110	FT604T		5/5.1	4.9	1.47	150
FT114T		7.5/5.1	4.9	1.08	110	FT614T		7.5/5.1	4.9	1.47	150

TEMPORARY

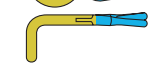
PERMANENT

Item No.		Diameter of fenestration 5 mm				Item No.		Diameter of fenestration 5 mm			
		Blade length mm L1/L2	Maximal opening mm	Closing force N g				Blade length mm L1/L2	Maximal opening mm	Closing force N g	
FT137T		3/9.8	7.4	1.08	110	FT637T		3/9.8	7.4	1.47	150
FT138T		4/10.8	7.4	1.08	110	FT638T		4/10.8	7.4	1.47	150
FT139T		5/11.8	7.4	1.08	110	FT639T		5/11.8	7.4	1.47	150
FT140T		6/12.7	7.9	1.08	110	FT640T		6/12.7	7.9	1.47	150
FT150T		9/15.7	9.1	1.08	110	FT650T		9/15.7	9.1	1.47	150
FT142T		5/9	6.5	1.08	110	FT642T		5/9.4	6.5	1.47	150
FT152T		7.5/10.6	7.2	1.08	110	FT652T		7.5/10.6	7.2	1.47	150
FT162T		10/12.2	7.8	1.08	110	FT662T		10/12.2	7.8	1.77	180
FT144T		5/6.7	5.5	1.08	110	FT644T		5/6.7	5.5	1.47	150
FT154T		7.5/6.7	5.5	1.08	110	FT654T		7.5/6.7	5.5	1.47	150

YASARGIL® Aneurysm Clip System

ULTRA SHORT FENESTRATED Clips

TITANIUM STANDARD

PERMANENT

"Dog-ear" Clips

Aneurysm clips with a particularly short blade length (3 mm) and fenestration serve for the treatment of minor aneurysms (e.g. "dog ear-aneurysms").

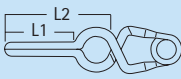
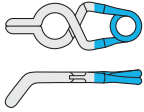
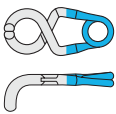
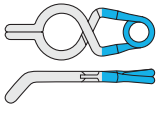
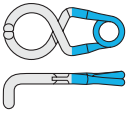
Item No.		Blade length mm L1/L2	Maximal opening mm	Closing force N	Diameter of fenestration mm
FT902T		3.0/6.3	5.8	1.47	3.5
FT904T		3.0/5.1	4.9	1.47	3.5
FT942T		3.0/8.1	6.0	1.47	5.0
FT944T		3.0/6.7	5.5	1.47	5.0

Titanium Reinforcing Clip

FT900T is intended to be used for increasing the closing force of YASARGIL Titanium Standard Aneurysm Clips. FT900T is not intended to be used as a stand alone clip.

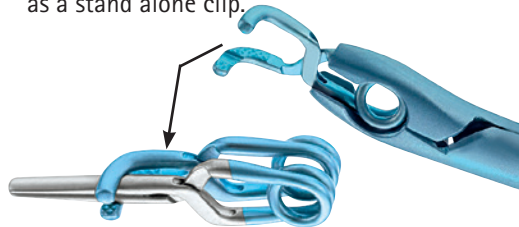

PERMANENT

Item No.

FT900T

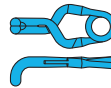

Titanium Mini Clips with Fenestration

PERMANENT

First Mini clips with fenestration



- Allows use of fenestrated clips in narrow spaces

Thin blades and a reduced triangle-shaped gap at the proximal end

- Supports the precise reconstruction of the vascular structure with multiple clipping techniques

Area of use

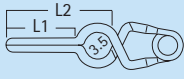
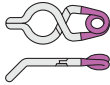
- Neck remnants of clipped aneurysms like "Dog-ear aneurysms"

Item No.		Blade length mm L1/L2	Maximal opening mm	Closing force N	Diameter of fenestration mm
FT802T		3.0/6.9	3.2	110	3.5
FT804T		3.0/5.1	3.2	110	3.5

TITANIUM STANDARD



Developed in co-operation with:

Rokuya Tanikawa, M. D.
Director Stroke Center, Department of Neurosurgery
Teishinkai Hospital, Sapporo, Japan

YASARGIL® Aneurysm Clip System

Titanium T-Bar Clips

TITANIUM T-BAR

PERMANENT

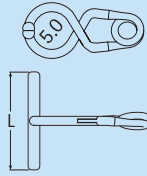
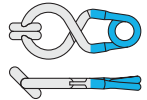
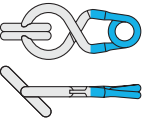
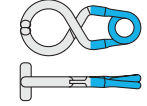
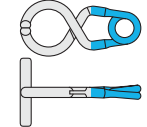
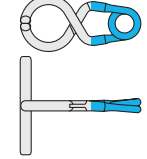
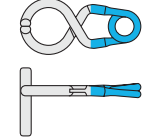
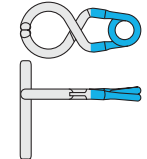
Item No.		Diameter of fenestration 5 mm				
		Blade length mm	Angle	Maximal opening mm	Closing force N g	
FT852T		5.0	45°	5.5	1.47	150
FT853T		9.0	45°	5.5	1.47	150
FT854T		5.0	90°	5.5	1.47	150
FT855T		9.0	90°	5.5	1.47	150
FT856T		13.0	90°	5.5	1.77	180
FT864T		9.0	90°	5.5	1.47	150
FT865T		13.0	90°	5.5	1.77	180

PERMANENT

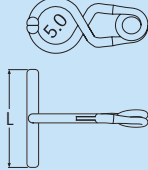
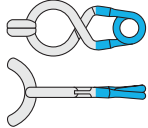
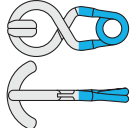
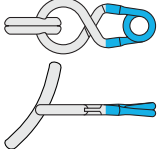
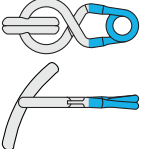
Item No.		Diameter of fenestration 5 mm				
		Blade length mm	Angle	Maximal opening mm	Closing force N g	
FT857T		9.0	90°	5.5	1.47	150
FT858T		9.0	90°	5.5	1.47	150
FT859T		13.0	60°	5.5	1.77	180
FT860T		13.0	60°	5.5	1.77	180

TITANIUM T-BAR

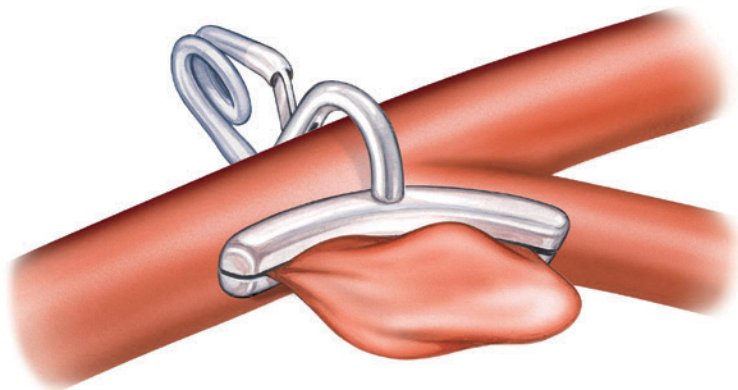

YASARGIL® Aneurysm Clip System



Titanium Mini Clips

TITANIUM MINI

TEMPORARY						PERMANENT					
Item No.		Blade length	Maximal opening	Closing force		Item No.		Blade length	Maximal opening	Closing force	
		mm	mm	N	g			mm	mm	N	g
FT180T		3.0	3.3	0.88	90	FT680T		3.0	3.3	1.08	110
FT190T		5.0	4.0	0.69	70	FT690T		5.0	4.0	1.08	110
FT200T		3.0	3.3	0.88	90	FT700T		3.0	3.3	1.08	110
FT210T		5.0	4.0	0.69	70	FT710T		5.0	4.0	1.08	110
FT220T		7.0	4.6	0.69	70	FT720T		7.0	4.6	1.08	110
FT182T		2.8	3.2	0.88	90	FT682T		2.8	3.2	1.08	110
FT194T		4.0	3.6	0.78	80	FT694T		4.0	3.6	1.08	110
FT192T		4.7	3.8	0.69	70	FT692T		4.7	3.8	1.08	110
FT211T		4.0	3.6	0.78	80	FT711T		4.0	3.6	1.08	110
FT212T		4.7	3.8	0.69	70	FT712T		4.7	3.8	1.08	110
FT213T		4.0	3.6	0.78	80	FT713T		4.0	3.6	1.08	110
FT226T		5.2	4.0	0.69	70	FT714T		3.9	3.5	1.08	110

TEMPORARY

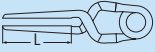
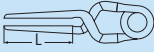
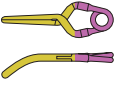
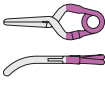
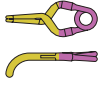
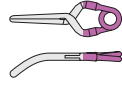
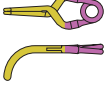
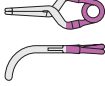
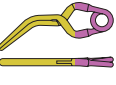
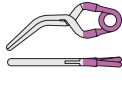
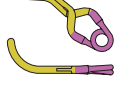
PERMANENT

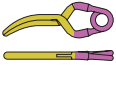
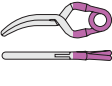
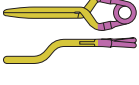
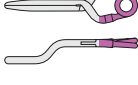
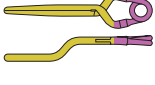
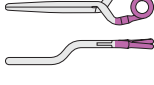
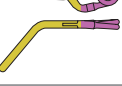
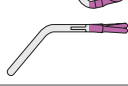
Item No.		Blade length mm	Maximal opening mm	Closing force		Item No.		Blade length mm	Maximal opening mm	Closing force	
				N	g					N	g
FT222T		6.6	4.4	0.69	70	FT726T		5.2	4.0	1.08	110
FT214T		3.9	3.5	0.78	80	FT722T		6.6	4.4	1.08	110
FT224T		5.0	4.0	0.69	70	FT724T		5.0	4.0	1.08	110
FT216T		5.0	3.5	0.69	70	FT716T		5.0	3.5	1.08	110
FT307T		4.7	4.0	0.69	70	FT807T		4.7	4.0	1.08	110
FT217T		6.3	6.0	0.69	70	FT717T		6.3	6.0	1.08	110
FT227T		4.0	7.0	0.69	70	FT727T		4.0	7.0	1.08	110
FT228T		7.0	5.7	0.69	70	FT728D		7.0	5.7	1.08	110
FT306T		7.0	4.5	0.69	70	FT806T		7.0	4.5	1.08	110

TITANIUM MINI

■ MR Conditional, 3-Tesla or less*

■ Color coding with violet spring (Mini clip) and golden or silver blades (temporary or permanent clip respectively)





■ Sterile packaging

* Please refer to the MRI Safety Information section of the Instructions for Use for MR-related safety information.

YASARGIL® Aneurysm Clip System

Double Bayonet Clip Applier

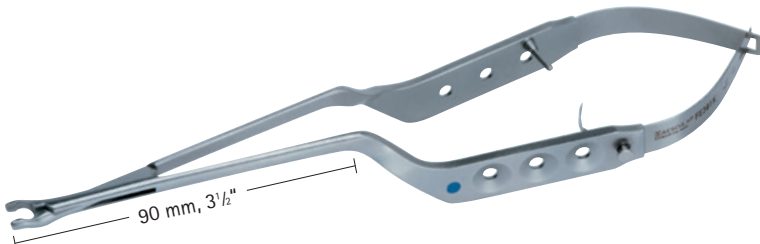
APPLIERS FOR TITANIUM CLIPS

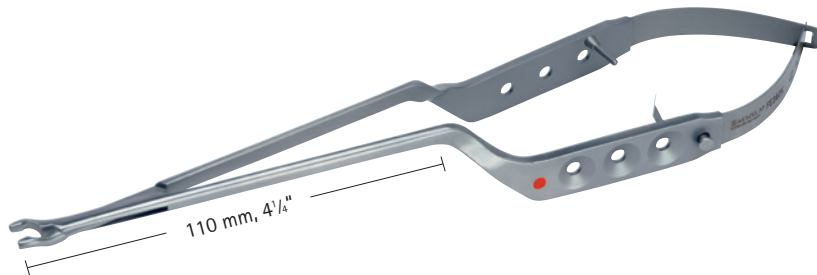
STANDARD	MINI		
			
FT501T	FT511T	with latch	 <p>90 mm, 3½"</p>
FT505T	FT515T	without latch	
		Total length: 225 mm, 8⅞"	
			
FT502T	FT512T	with latch	 <p>110 mm, 4¼"</p>
FT506T	FT516T	without latch	
		Total length: 245 mm, 9⅝"	



- The Double Bayonet Clip Applier has an additional bayonet shape at the jaw.



- This allows for a better view of the clip.

Titanium Vario Clip Applier

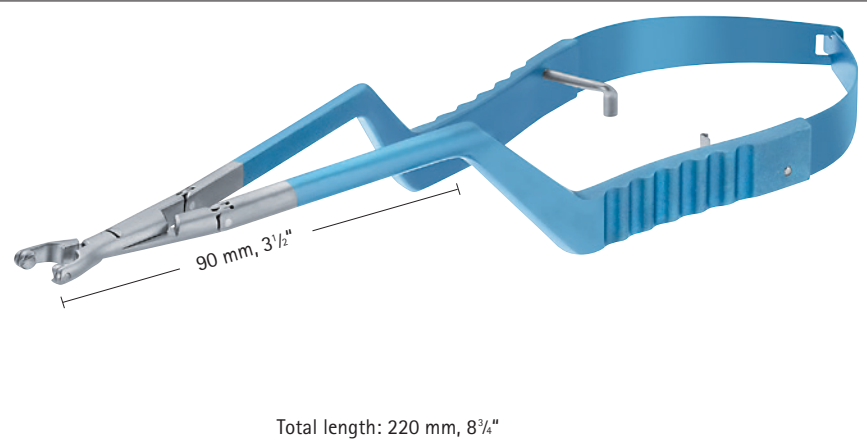
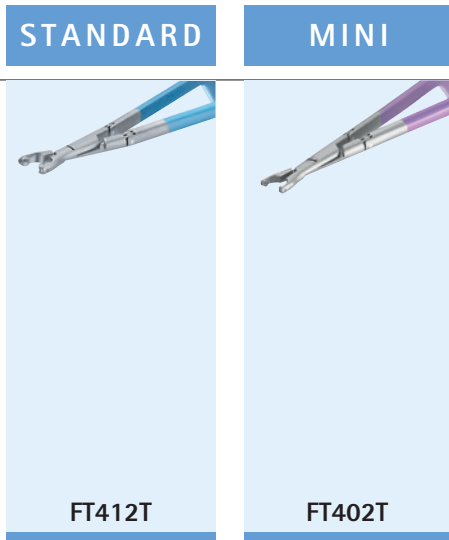

APPLIERS FOR TITANIUM CLIPS

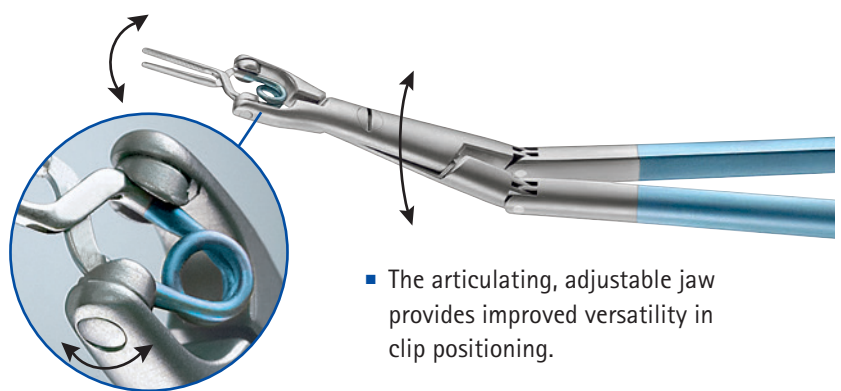

Adjusting Key



YASARGIL[®] Aneurysm Clip System

XS Clip Applier for Titanium Clips

APPLIERS FOR TITANIUM CLIPS

STANDARD

MINI



FT495T

FT490T

Total length: 230 mm, 9"



FT496T

FT491T

Total length: 250 mm, 9 3/4"

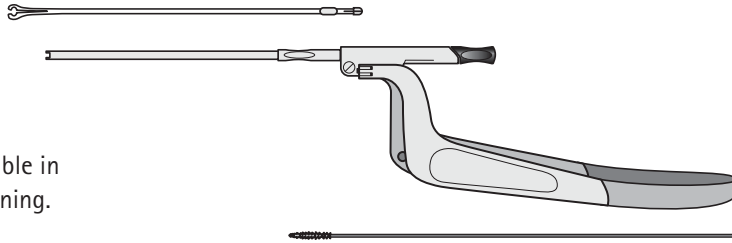
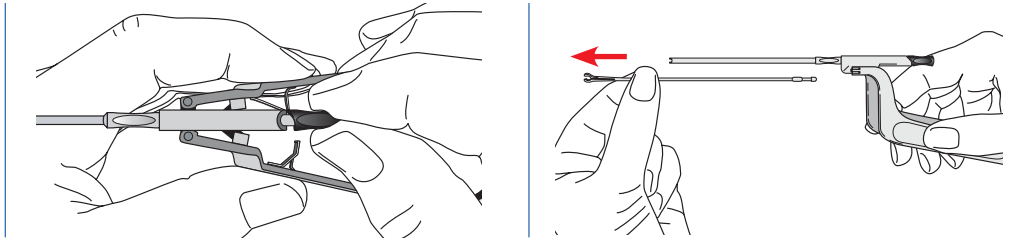

Disassembly

The XS Applier is detachable in 2 parts for thorough cleaning.









A cleaning brush is included with every applier.

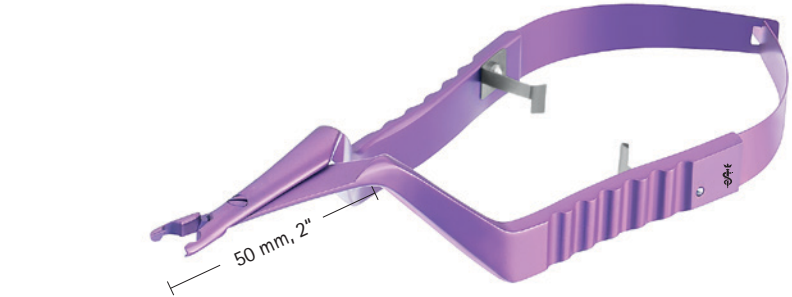

YASARGIL[®] Aneurysm Clip System

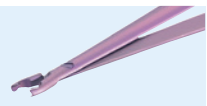
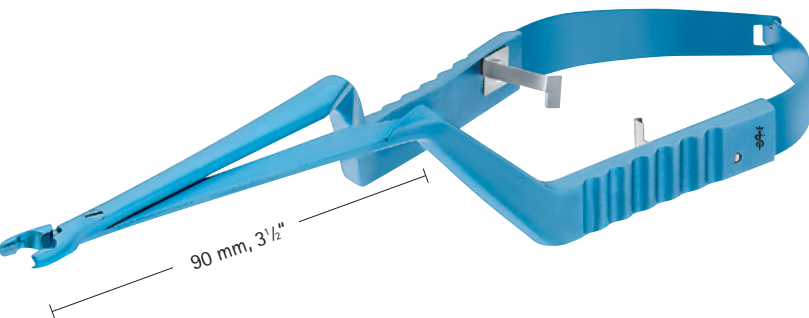
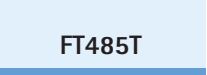
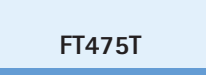
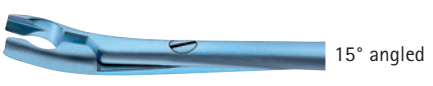
Clip Applier for Titanium Clips

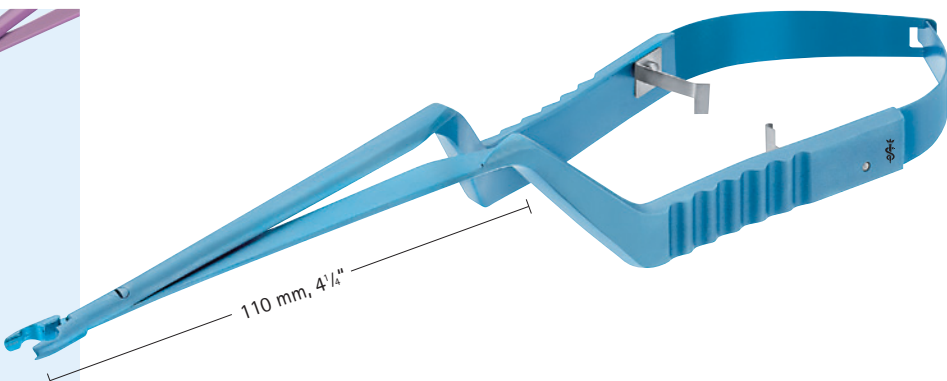
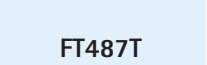
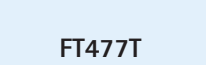
APPLIERS FOR TITANIUM CLIPS

STANDARD		MINI	
			
FT480T	FT470T	straight	Total length: 180 mm, 7"
			
FT482T	FT472T	straight	
			Total length: 220 mm, 8 3/4"
FT485T	FT475T	15° angled	
			
FT484T	FT474T	straight	
			Total length: 250 mm, 9 3/4"
FT487T	FT477T	15° angled	

Removing Forceps for Titanium Clips

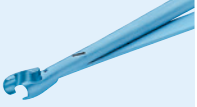
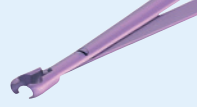
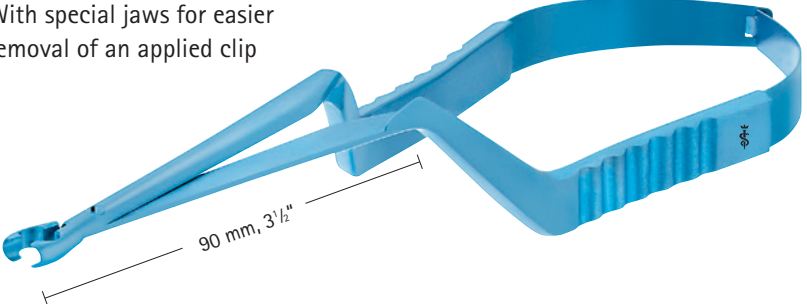
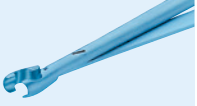
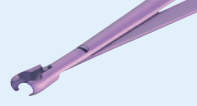
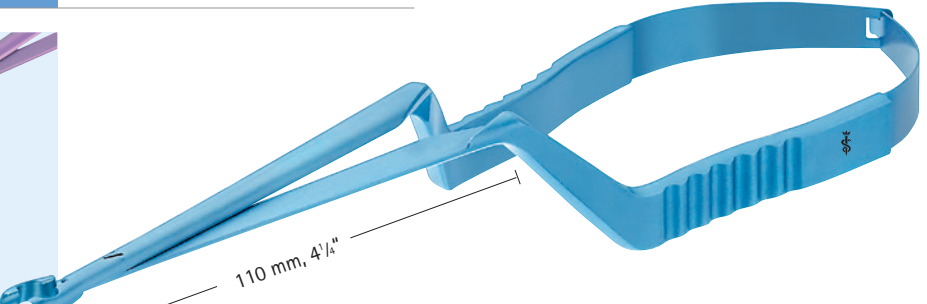
STANDARD	MINI		
 <p data-bbox="203 877 292 905">FT082T</p>	 <p data-bbox="435 877 524 905">FT072T</p>	<ul style="list-style-type: none"> With special jaws for easier removal of an applied clip 	 <p data-bbox="607 877 837 905">Total length: 220 mm, 8 3/4"</p>
 <p data-bbox="203 1297 292 1325">FT083T</p>	 <p data-bbox="435 1297 524 1325">FT073T</p>		 <p data-bbox="607 1297 837 1325">Total length: 250 mm, 9 3/4"</p>

Phynox Clips and Appliers





PHYNOX

YASARGIL® Aneurysm Clip System

Phynox Standard Clips

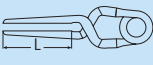
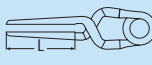
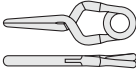
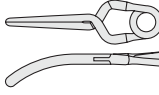
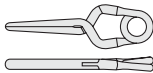
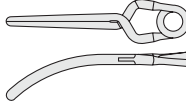
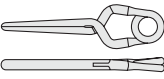
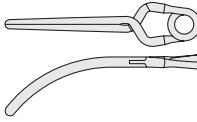
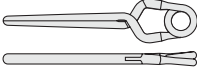
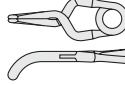
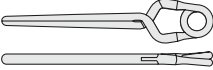
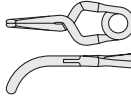
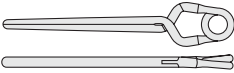
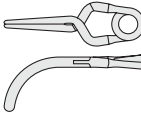
PHYNOX STANDARD

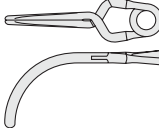
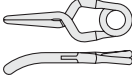
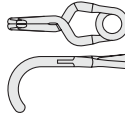
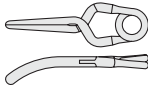
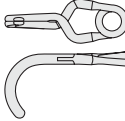
PERMANENT						PERMANENT					
Item No.		Blade length mm	Maximal opening mm	Closing force N g		Item No.		Blade length mm	Maximal opening mm	Closing force N g	
FE740K		7.0	6.2	1.47	150	FE762K		10.2	7.5	1.77	180
FE750K		9.0	7.0	1.77	180	FE782K		13.7	8.7	1.96	200
FE760K		11.0	7.8	1.77	180	FE786K		15.3	9.8	1.96	200
FE780K		15.0	9.2	1.96	200	FE744K		5.4	5.5	1.47	150
FE792K		17.5	10.6	1.96	200	FE754K		6.4	6.1	1.77	180
FE790K		20.0	11.4	1.96	200	FE764K		8.0	6.5	1.77	180
FE840K		25.0	13.3	1.77	180	FE784K		10.3	7.4	1.96	200
FE742K		6.5	6.0	1.47	150	FE823K		7.4	5.4	1.77	180
FE752K		8.3	6.8	1.77	180	FE824K		8.4	5.8	1.77	180

PERMANENT

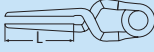
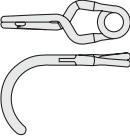
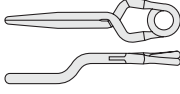
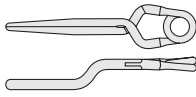
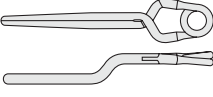
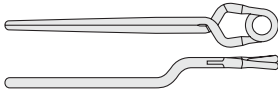
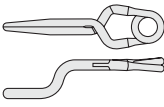
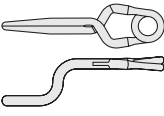
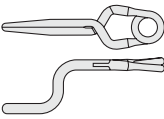
Item No.		Blade length	Maximal opening	Closing force	
		mm	mm	N	g
FE825K		10.5	6.2	1.77	180
FE748K		7.0	7.9	1.96	200
FE758K		9.0	8.7	1.96	200
FE759K		12.0	10.2	1.96	200
FE798K		20.0	13.0	1.77	180
FE770K		5.0	8.0	1.96	200
FE771K		5.0	8.0	1.96	200
FE772K		5.0	8.0	1.96	200

PERMANENT

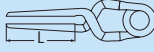
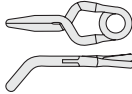
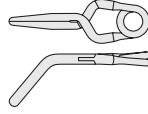
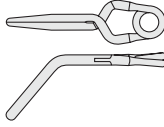
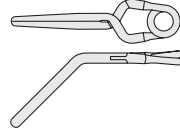
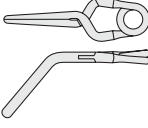
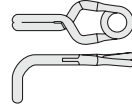
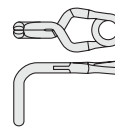
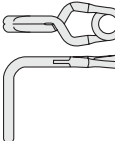
Item No.		Blade length	Maximal opening	Closing force	
		mm	mm	N	g
FE603K		6.1	6.5	1.96	200
FE613K		8.0	6.2	1.96	200
FE623K		10.6	7.8	1.96	200
FE763K		11.8	8.4	1.96	200
FE810K		9.0	6.5	1.96	200
FE819K		5.0	5.6	1.96	200
FE820K		7.0	4.5	1.96	200
FE822K		10.0	5.6	1.96	200

■ MR Conditional, 3-Tesla or less*

■ Color coding with silver spring and blades (permanent clip)

■ Sterile packaging





* Please refer to the MRI Safety Information section of the Instructions for Use for MR-related safety information.

YASARGIL® Aneurysm Clip System



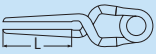
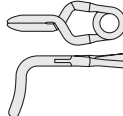
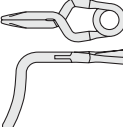
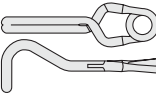

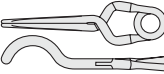
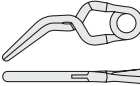
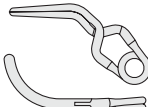
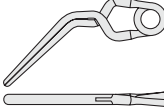

Phynox Standard Clips

PERMANENT

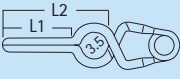
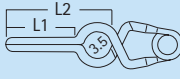
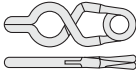
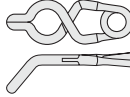
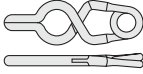
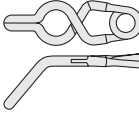
PHYNOX STANDARD

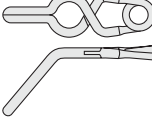
Item No.		Blade length	Maximal opening	Closing force	
		mm	mm	N	g
FE850K		6.7	5.4	1.96	200
FE851K		9.0	5.6	1.96	200
FE830K		7.0	7.2	1.96	200
FE832K		9.3	7.2	1.96	200
FE833K		11.3	8.2	1.96	200
FE746K		7.0	5.7	1.96	200
FE773K		7.8	6.5	1.77	180
FE761K		11.4	8.0	1.96	200
FE747K		8.6	7.0	1.77	180

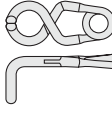

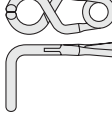
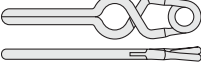
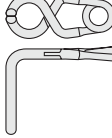
Phynox Standard Clips with Fenestration

PERMANENT						PERMANENT					
Item No.		Diameter of fenestration 3.5 mm				Item No.		Diameter of fenestration 3.5 mm			
		Blade length mm L1/L2	Maximal opening mm	Closing force N g				Blade length mm L1/L2	Maximal opening mm	Closing force N g	
FE597K		3/8.1	6.5	1.47	150	FE602K		5/7.3	5.8	1.47	150
FE598K		4/9.1	6.6	1.47	150	FE612K		7.5/8.9	6.5	1.47	150
FE599K		5/10.1	7.0	1.47	150	FE622K		10/10.5	7.2	1.77	180
FE600K		6/11	7.4	1.47	150	FE604K		5/4.9	4.9	1.47	150
FE610K		9/14	8.4	1.47	150	FE614K		7.5/4.9	4.9	1.47	150
FE620K		12/17	9.6	1.77	180	FE624K		10/4.9	4.9	1.77	180

YASARGIL® Aneurysm Clip System

Phynox Standard Clips with Fenestration

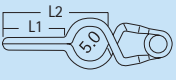
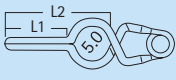
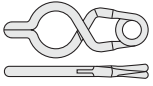
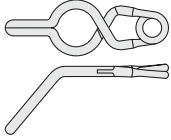
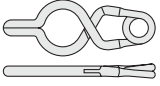
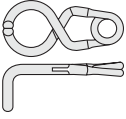
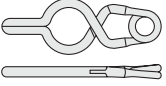
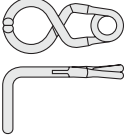
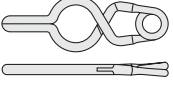
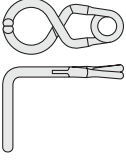
PHYNOX STANDARD

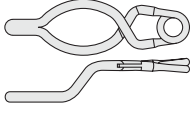
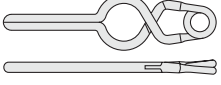
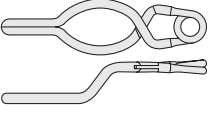
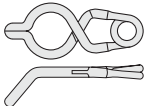
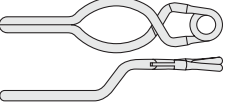
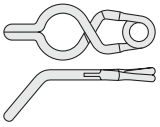
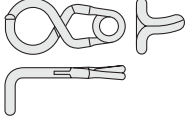
PERMANENT						PERMANENT					
Item No.		Blade length mm L1/L2	Maximal opening mm	Closing force N g		Item No.		Blade length mm L1/L2	Maximal opening mm	Closing force N g	
FE637K		3/9.8	6.7	1.47	150	FE662K		10/12.2	7.8	1.77	180
FE638K		4/10.8	7.1	1.47	150	FE644K		5/6.4	5.5	1.47	150
FE639K		5/11.8	7.5	1.47	150	FE654K		7.5/6.4	5.5	1.47	150
FE640K		6/12.7	7.9	1.47	150	FE664K		10/6.4	5.5	1.77	180
FE650K		9/15.7	9.1	1.47	150	FE648K		5/15.2	7.9	1.47	150
FE660K		12/18.7	10.3	1.77	180	FE658K		7.5/17.7	8.8	1.47	150
FE642K		5/9	6.5	1.47	150	FE668K		10/20.2	10.0	1.77	180
FE652K		7.5/10.6	7.2	1.47	150	FE774K		5/6.7	5.0	1.47	150

PERMANENT

PERMANENT

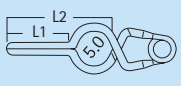
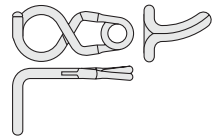
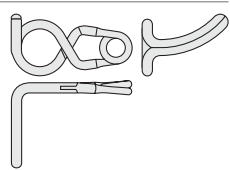
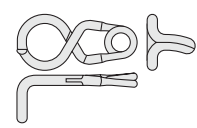
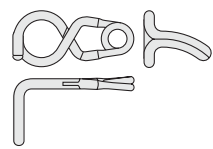
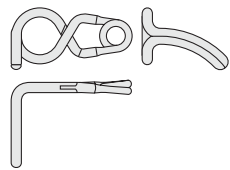
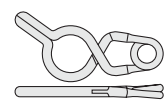
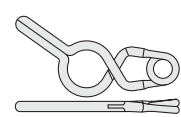
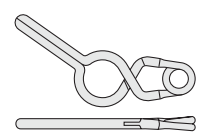
Item No.		Blade length mm L1/L2	Maximal opening mm	Closing force	
				N	g
FE775K		7.5/6.7	5.0	1.47	150
FE776K		10/6.7	5.0	1.47	150
FE777K		5/6.7	5.0	1.47	150
FE778K		7.5/6.7	5.0	1.47	150
FE779K		10/6.7	5.0	1.47	150
FE881K		5/10.4	7.0	1.47	150
FE882K		7.5/12.4	7.8	1.47	150
FE883K		10/14.5	8.8	1.47	150

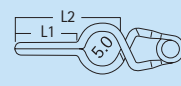
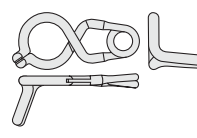
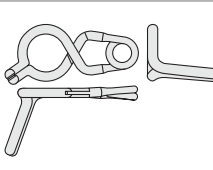
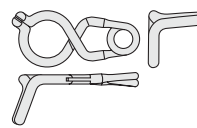
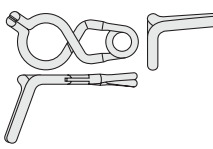
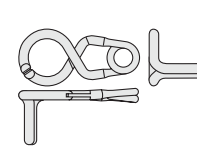
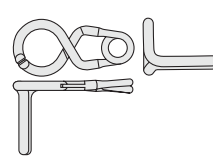
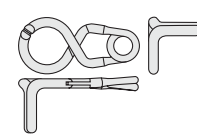
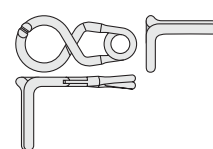
Item No.		Blade length mm L1/L2	Maximal opening mm	Closing force	
				N	g
FE886K		5/7.4	5.0	1.47	150
FE887K		7.5/8.1	5.0	1.47	150
FE888K		5/7.4	5.0	1.47	150
FE889K		7.5/8.1	5.0	1.47	150
FE891K		5/6.6	5.0	1.47	150
FE892K		7.5/6.6	5.0	1.47	150
FE893K		5/6.6	5.0	1.47	150
FE894K		7.5/6.6	5.0	1.47	150

YASARGIL® Aneurysm Clip System

Phynox T-Bar Clips acc. to KOPITNIK, 5.0 mm

Aneurysm clip with a unique design

The blades of the T-Bar Clip are oriented in a 90° or 45° angle to the axis of the spring resulting in a T-like clip form. The unique shape opens up new options for the treatment of complicated cerebral aneurysms. The spring type is identical to the existing and proven standard YASARGIL Aneurysm Clip with a 5 mm diameter fenestration.

PERMANENT

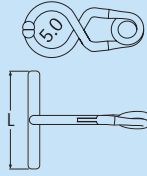
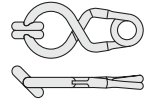
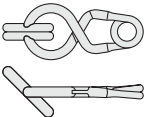
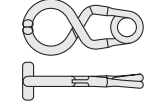
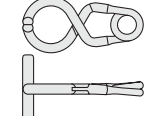
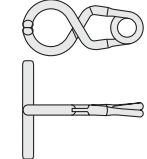
Item No.		Diameter of fenestration 5 mm				
		Blade length mm	Angle	Maximal opening mm	Closing force N g	
FE852K		5.0	45°	5.5	1.47	150
FE853K		9.0	45°	5.5	1.47	150
FE854K		5.0	90°	5.5	1.47	150
FE855K		9.0	90°	5.5	1.47	150
FE856K		13.0	90°	5.5	1.77	180

ULTRA SHORT FENESTRATED Clips, 5.0 mm

PERMANENT

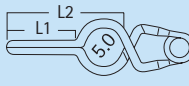
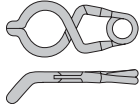
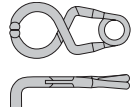
Item No.		Diameter of fenestration 5 mm		
		Blade length mm L1/L2	Maximal opening mm	Closing force N
FE942K		3.0/8.1	6.0	1.47
FE944K		3.0/6.4	5.5	1.47

PHYNOX STANDARD

Phynox Reinforcing Clip

FE900K is intended to be used for increasing the closing force of YASARGIL® Phynox Standard Aneurysm Clips. FE900K is not intended to be used as a stand alone clip.

PERMANENT

Item No.

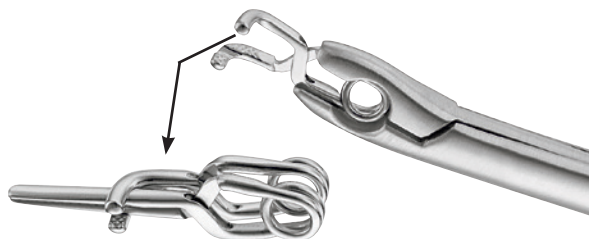

FE900K

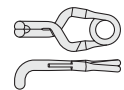





YASARGIL® Aneurysm Clip System

Phynox Long Clips and Applier

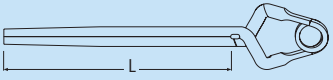
PERMANENT

PHYNOX LONG

Item No.		Blade length mm L1/L2	Maximal opening mm	Closing force N g	
FE861K		30	19	1.86	190
FE862K		35	21	1.96	200
FE863K		40	23	1.96	200

- Clip with extra long blades for the treatment of giant aneurysms.

Clip Applier for Long Clips

- With "active" locking mechanism; the applier can be used with or without the lock being activated.





FE560K

Total length: 200 mm, 7 7/8"

Phynox Standard and Mini Clips

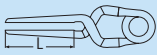
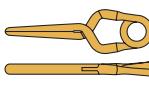
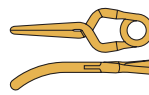
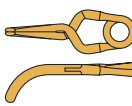
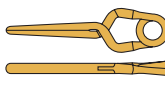
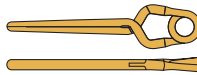
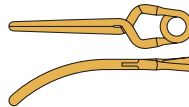
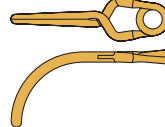
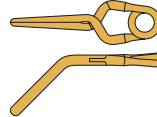

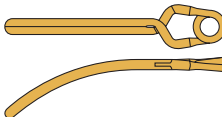
TEMPORARY (STANDARD)

Item No.		Blade length mm L1/L2	Maximal opening mm	Closing force	
				N	g
FE751K		9.0	7.0	0.69	70
FE753K		8.4	6.8	0.69	70
FE755K		6.7	6.1	0.69	70
FE769K		11.0	7.8	0.69	70
FE781K		15.0	9.2	0.69	70
FE783K		13.8	8.7	0.69	70
FE785K		10.4	7.4	0.69	70
FE756K		9.1	6.2	0.69	70
FE791K		20.0	11.4	0.88	90
FE793K		18.7	11.0	0.88	90

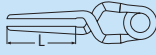
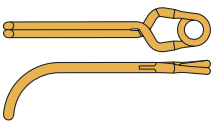
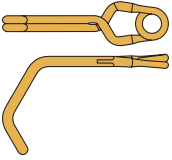
TEMPORARY (STANDARD)

Item No.		Blade length mm L1/L2	Maximal opening mm	Closing force	
				N	g
FE795K		16.8	9.9	0.88	90
FE801K		13.0	7.5	0.88	90

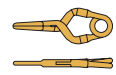
TEMPORARY (MINI)

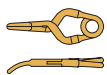
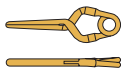
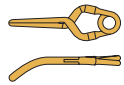
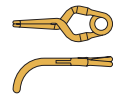









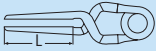
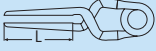

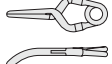
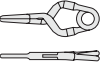
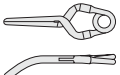
FE681K		3.0	3.3	0.49	50
FE691K		5.0	4.0	0.49	50
FE683K		2.8	3.2	0.49	50
FE693K		4.7	3.8	0.49	50
FE721K		7.0	4.6	0.69	70
FE723K		6.6	4.4	0.69	70
FE725K		5.0	4.0	0.69	70

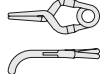
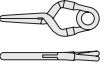
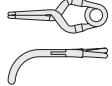
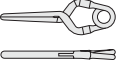
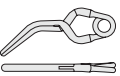
PHYNOX STANDARD AND MINI

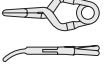
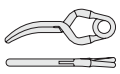
YASARGIL® Aneurysm Clip System

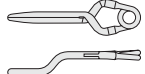
Phynox Standard and Mini Clips

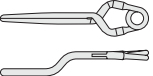
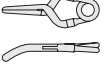
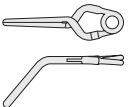
PHYNOX MINI

PERMANENT (MINI)						PERMANENT (MINI)					
Item No.		Blade length mm L1/L2	Maximal opening mm	Closing force N g		Item No.		Blade length mm L1/L2	Maximal opening mm	Closing force N g	
FE680K		3.0	3.3	1.08	110	FE726K		5.2	4.0	1.08	110
FE690K		5.0	4.0	1.08	110	FE722K		6.6	4.4	1.08	110
FE700K		3.0	3.3	1.08	110	FE714K		3.9	3.5	1.08	110
FE710K		5.0	4.0	1.08	110	FE724K		5.0	4.0	1.08	110
FE720K		7.0	4.6	1.08	110	FE716K		5.0	3.5	1.28	130
FE682K		2.8	3.2	1.08	110	FE807K		4.7	4.0	1.08	110
FE692K		4.7	3.8	1.08	110	FE717K		6.3	6.0	1.28	130
FE694K		4.0	3.6	1.08	110	FE727K		4.0	7.0	1.28	130
FE711K		4.0	3.6	1.08	110	FE728K		7.0	5.7	1.28	130
FE712K		4.7	3.8	1.08	110	FE806K		7.0	4.5	1.28	130
FE713K		4.0	3.6	1.08	110						

■ MR Conditional, 3-Tesla or less*

■ Color coding with gold spring and blades (temporary clip) and silver spring and blades (permanent clip)

* Please refer to the MRI Safety Information section of the Instructions for Use for MR-related safety information.

Vario Clip Applier for Phynox Clips

STANDARD	MINI
<p>For AESCULAP YASARGIL STANDARD - Phynox-Clips only</p> <p>FE512T</p>	<p>For AESCULAP YASARGIL MINI - Phynox-Clips only</p> <p>FE502T</p>

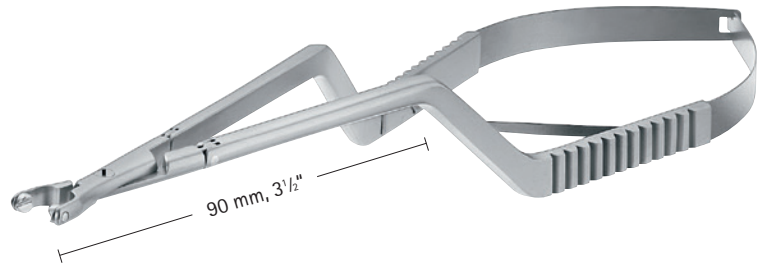

Total length: 220 mm, 8 3/4"

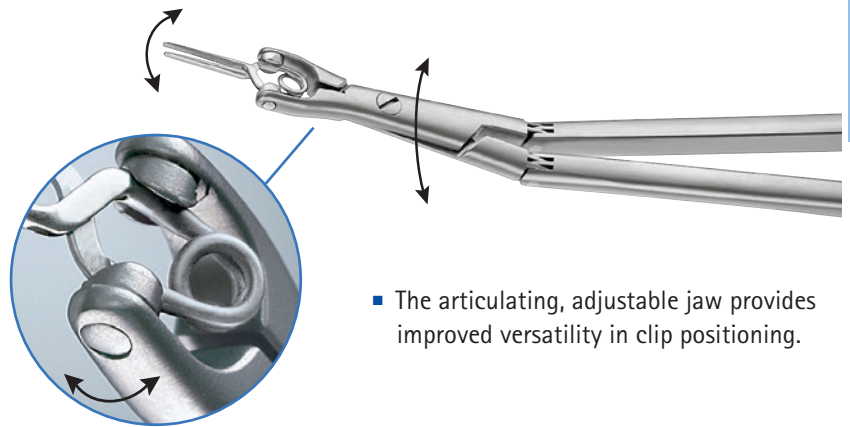

- The articulating, adjustable jaw provides improved versatility in clip positioning.

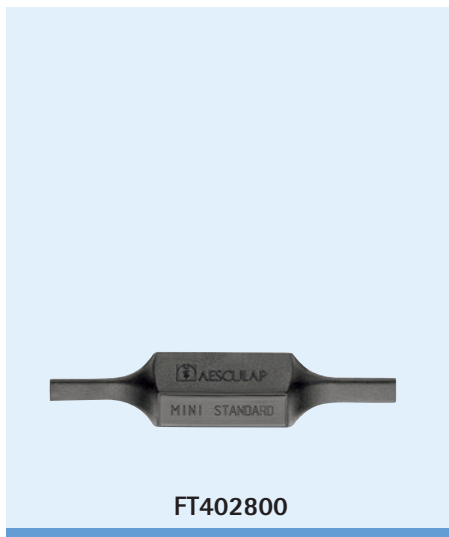

FT402800

Adjusting Key



- Adjusting Key for Vario Clip Applier for setting the swivel at an angle.

■ Distinction between Standard and Mini appliers through label on the spring

YASARGIL® Aneurysm Clip System

XS Clip Applier for Phynox Clips

APPLIERS FOR PHYNOX CLIPS

STANDARD

MINI



- 360° rotation
- Suitable for narrow approaches

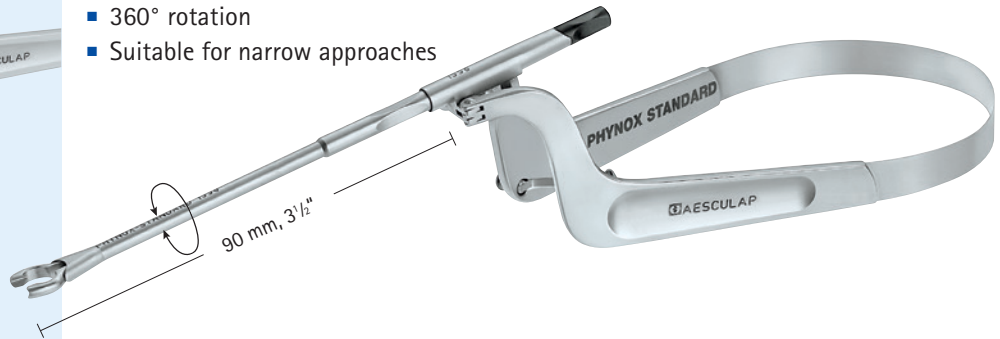

FE495K

FE490K

Total length: 230 mm, 9"



FE496K

FE491K

Total length: 250 mm, 9 3/4"

Disassembly

The XS Applier is detachable in 2 parts for thorough cleaning.



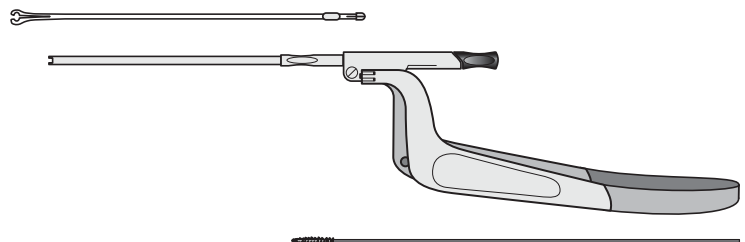
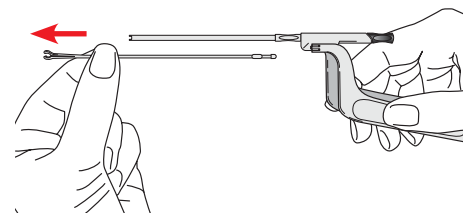
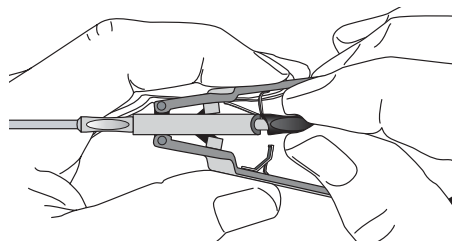





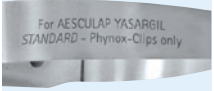
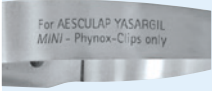
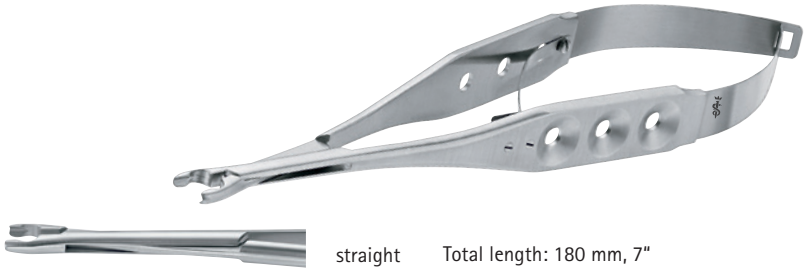

A cleaning brush is included with every applier.

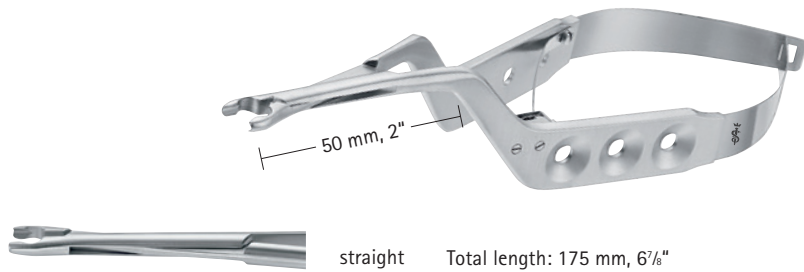

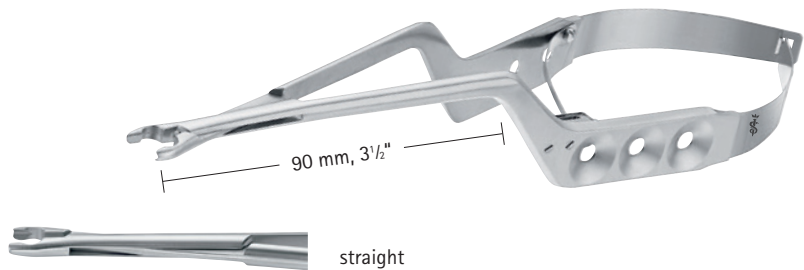
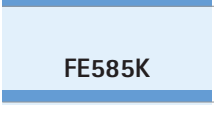
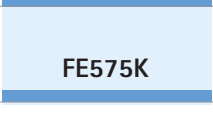
■ Standard and Mini Clip identifiers are located on the label inside the handle

YASARGIL® Aneurysm Clip System

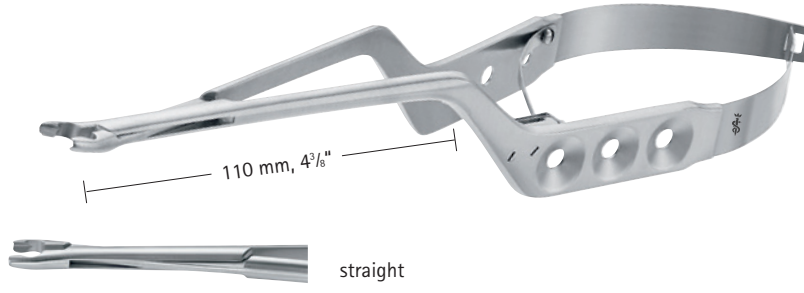
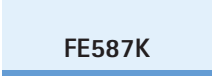
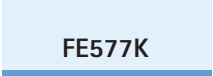
Clip Applier for Phynox Clips

STANDARD		MINI			
 <p>For AESCULAP YASARGIL STANDARD - Phynox-Clips only</p> <p>FE558K</p>	 <p>For AESCULAP YASARGIL MINI - Phynox-Clips only</p> <p>FE548K</p>	 <p>straight</p> <p>Total length: 180 mm, 7"</p>			
 <p>For AESCULAP YASARGIL STANDARD - Phynox-Clips only</p> <p>FE580K</p>	 <p>For AESCULAP YASARGIL MINI - Phynox-Clips only</p> <p>FE570K</p>	 <p>50 mm, 2"</p> <p>straight</p> <p>Total length: 175 mm, 6⁷/₈"</p>			
 <p>For AESCULAP YASARGIL STANDARD - Phynox-Clips only</p> <p>FE582K</p>	 <p>For AESCULAP YASARGIL MINI - Phynox-Clips only</p> <p>FE572K</p>	 <p>90 mm, 3¹/₂"</p> <p>straight</p>			
 <p>FE585K</p>	 <p>FE575K</p>	 <p>15° angled</p> <p>Total length: 215 mm, 8¹/₂"</p>			
 <p>For AESCULAP YASARGIL STANDARD - Phynox-Clips only</p> <p>FE584K</p>	 <p>For AESCULAP YASARGIL MINI - Phynox-Clips only</p> <p>FE574K</p>	 <p>110 mm, 4³/₈"</p> <p>straight</p>			
 <p>FE587K</p>	 <p>FE577K</p>	 <p>15° angled</p> <p>Total length: 215 mm, 8¹/₂"</p>			

APPLIERS FOR PHYNOX CLIPS

YASARGIL® Aneurysm Clip System

Storage

FT007P
FT006P

Clip Tray – Full

For storage, transport and sterilization of Aesculap YASARGIL® Aneurysm Clips.

- Autoclavable plastic
- Fits 1/1 standard container
- 34 storage compartments for Standard and Mini Clips
- 4 storage compartments for Long Clips
- With special identification tags for individual tray configuration

Clip Tray – Half

For storage, transport and sterilization of Aesculap YASARGIL® Aneurysm Clips.

- Autoclavable plastic
- Fits 1/2 standard container
- 15 storage compartments for Standard and Mini Clips
- 3 storage compartments for Long Clips
- With special identification tags for individual tray configuration

FT006P



FT007P

Storage



Identification tags for the Clip Trays

Allow quick and easy recording of the necessary clip data;
Helpful for classifying and reordering the clips that have been removed.

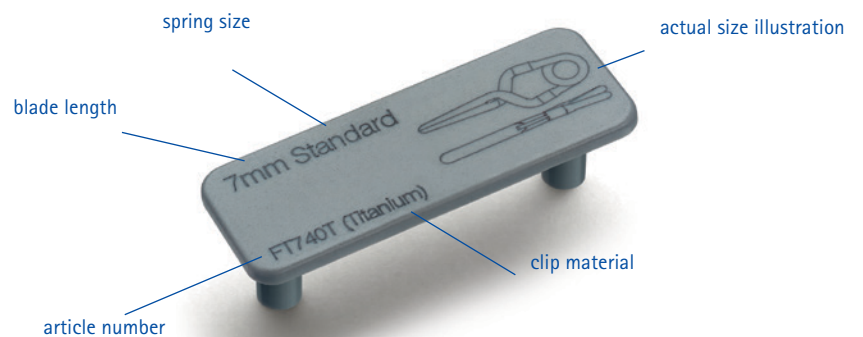

For each clip variant there is a matching identification tag.
The article numbers of the tags are as follows:
Item No. of clip + "-TAG"

e.g.: FT740T-TAG is the identification tag for the clip FT740T

The identification tags for temporary clips are **yellow** and for permanent clips **grey**
in line with the color coding of the YASARGIL Aneurysm Clips.

YASARGIL® Aneurysm Clip System

Storage

FM665R

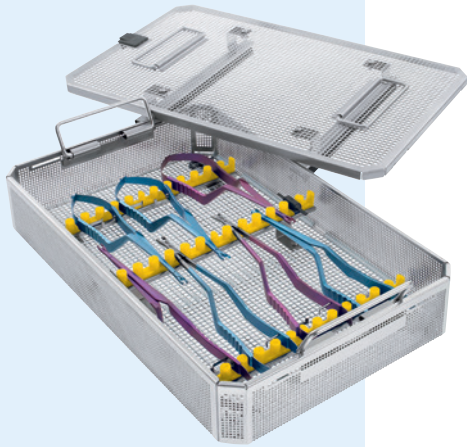

Storage for clip applicators

Perforated basket with lid, for storage of clip applicators

Patient identification card for Clip implants

- Provides traceability for physician and patient for follow-ups
- Includes information about the MRI-compatibility of the clips
- Printed version available via AIC Literature website



Kopitnik AVM Micro Clip System



AVM MICRO CLIP SYSTEM

For the treatment of arteriovenous malformations.









AVM Micro System

Micro Clips

AVM MICRO CLIP SYSTEM

Sterile AVM Micro Clips straight, closing force between 50 g and 70 g

Sterile AVM Micro Clips curved, closing force between 50 g and 70 g

Blade Length	Max. Opening Width	Single Pack		Blade Length	Max. Opening Width	Single Pack	
2 mm, 1/13"	1.5 mm, 1/17"	FE952K		2 mm, 1/13"	1.5 mm, 1/17"	FE962K	
3 mm, 1/8"	1.7 mm, 1/15"	FE953K		3 mm, 1/8"	1.7 mm, 1/15"	FE963K	
4 mm, 1/6"	2.0 mm, 1/13"	FE954K		4 mm, 1/6"	2.0 mm, 1/13"	FE964K	
5 mm, 1/5"	2.3 mm, 1/11"	FE955K		5 mm, 1/5"	2.3 mm, 1/11"	FE965K	

Note: 1 pack sterile, straight and curved



Packaging with 1 Sterile AVM Micro Clip

Indications for Use:

The Aesculap AVM Microclips are intended for intracranial vascular occlusion (permanent or temporary) of small vessels.

The Aesculap AVM Microclip Applier is intended for holding and applying intracranial AVM Microclips.

See Instructions for Use for additional information including Warnings and Precautions.

Rx Only.

Micro Clip Applier

STANDARD

XS - Design



FE907K

Working length: 70 mm, 2³/₄"

FE908K

Working length: 90 mm, 3¹/₂"

FE909K

Working length: 110 mm, 4¹/₂"

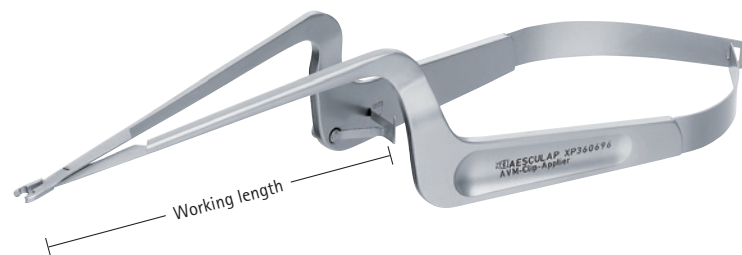

FE917K

Working length: 70 mm, 2³/₄"

FE918K

Working length: 90 mm, 3¹/₂"

AVM Clip System

Micro Coil Scissors

STANDARD

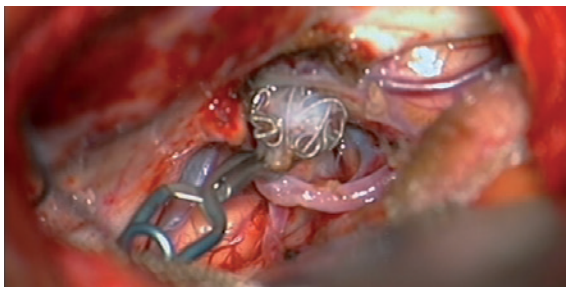
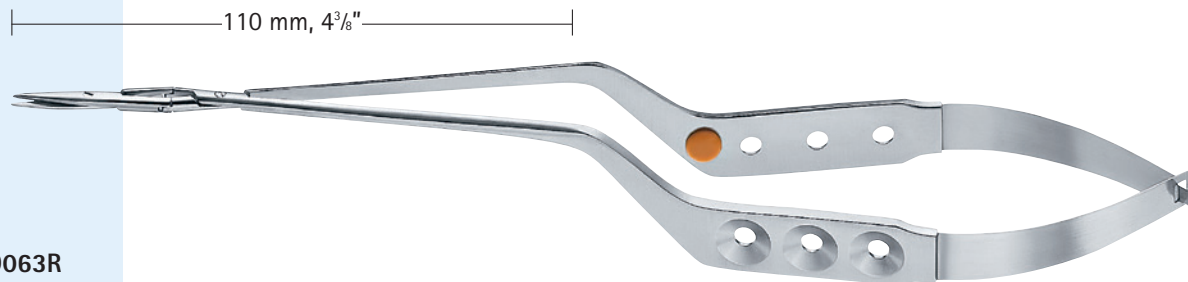
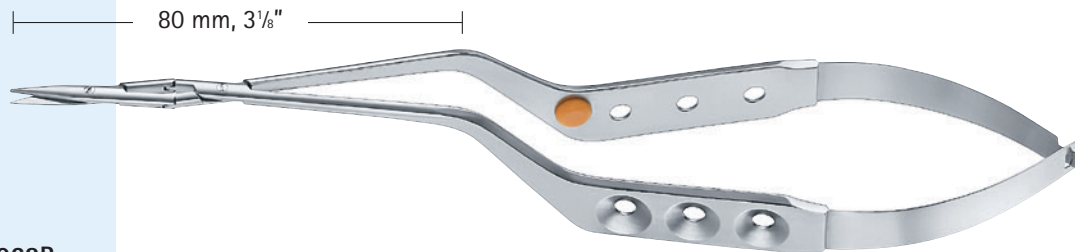

In special cases, coil wires have to be cut and removed. For this procedure, special coil scissors are extremely helpful.

"With the new coil scissors it is simple and safe to cut the coils - a very helpful tool when you have to operate on an aneurysm that had been previously treated via an endovascular approach."

Developed in co-operation with:
Dr. Thomas A. Kopitnik, Jr.
Central Wyoming Neurosurgery
Casper, Wyoming, USA

Notes

All rights reserved. Technical alterations are possible. This leaflet may be used for no other purposes than offering, buying and selling of our products. No part may be copied or reproduced in any form. In the case of misuse we retain the rights to recall our catalogs and price lists and to take legal actions.

©2018 AESCULAP. ALL RIGHTS RESERVED. PRINTED IN THE USA.
Aesculap is an equal opportunity employer

Aesculap, Inc. | 3773 Corporate Parkway | Center Valley, PA | 18034
Phone 800-282-9000 | Fax 610-791-6886 | www.aesculapusa.com

Aesculap, Inc. - a B. Braun company

DOC697 Rev. H 11/18