



Ear/Nose/Throat

| | |
|---|--------------|
| Scissors | 526-539, 636 |
| Needles | 540 |
| Tissue, Dressing & Sponge Forceps | 541-556 |
| Hooks & Retractors | 557-566 |
| Adenotomes, Dissectors & Snares | 567-572 |
| Mouth Gags | 573-579 |
| Specula | 580-588 |
| Cotton Carriers | 589-590 |
| Knives | 591-594 |
| Suction/Irrigation | 595-598 |
| Bone Instruments | 599-613 |
| Elevators & Curettes | 614-624 |
| Rongeurs | 625-630 |
| Accessories | 631-635 |

Ear/Nose/Throat

Scissors

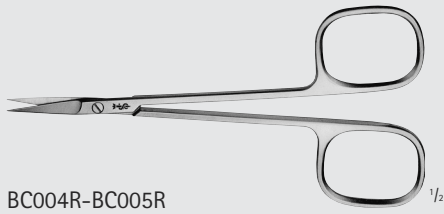

BC004R-BC005R

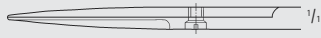

BC004R

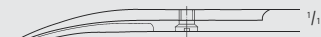

BC005R

Iris Scissors, Delicate

| Catalog Number | Tip | Blade | Handle | Length (in.) |
|----------------|-----|-------|--------|--------------|
| BC004R | S/S | STR | SQUARE | 4 1/2 |
| BC005R | S/S | CVD | SQUARE | 4 1/2 |

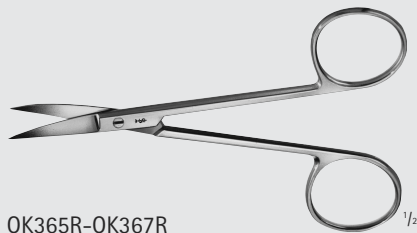

OK365R-OK367R



OK365R

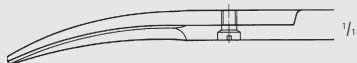

OK367R

COTTLE-MASING Plastic Scissors

| Catalog Number | Tip | Blade | Length (in.) |
|----------------|-----|-------|--------------|
| OK365R | S/S | CVD | 4 1/8 |
| OK367R | B/B | CVD | 4 1/8 |

ENT

MILLIMETERS

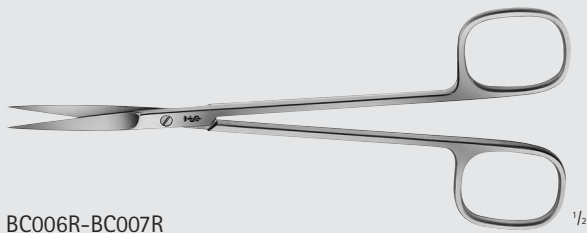

BC006R-BC007R

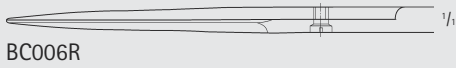

BC006R

JOSEPH Scissors, Delicate

| Catalog Number | Tip | Blade | Handle | Length (in.) |
|----------------|-----|-------|--------|--------------|
| BC006R | S/S | STR | SQUARE | 6 |
| BC007R | S/S | CVD | SQUARE | 6 |
| BC156R | S/S | STR | ROUND | 6 |
| BC157R | S/S | CVD | ROUND | 6 |

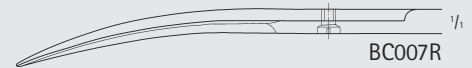

BC007R

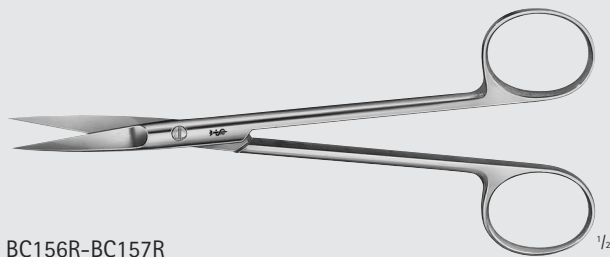

BC156R-BC157R

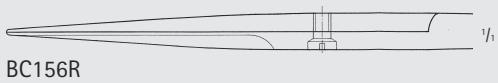

BC156R

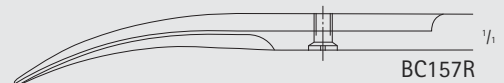

BC157R

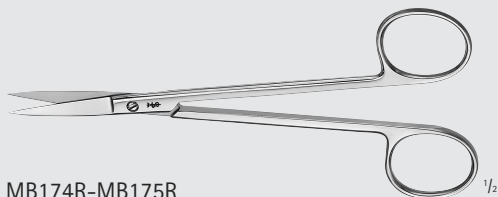

MB174R-MB175R



MB174R

JOSEPH Scissors

| Catalog Number | Tip | Blade | Length (in.) |
|----------------|-----|-----------|--------------|
| MB174R | S/S | STR, SERR | 5 1/2 |
| MB175R | S/S | CVD, SERR | 5 1/2 |



MB175R

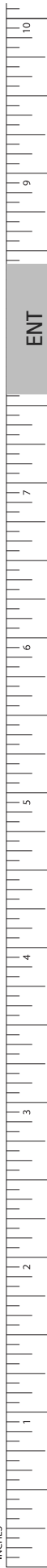

INCHES

Ear/Nose/Throat

Scissors

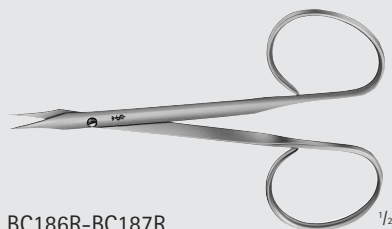

BC186R-BC187R

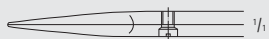

BC186R



BC187R

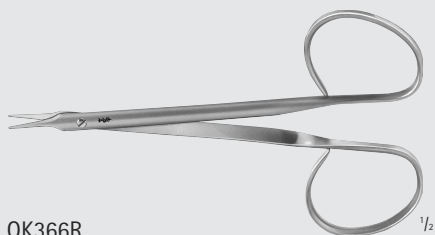

OK366R

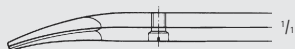

STEVENS Tenotomy Scissors, Fine

| Catalog Number | Tip | Blade | Handle | Length (in.) |
|----------------|-----|-------|--------|--------------|
| BC186R | S/S | STR | RIBBON | 4 |
| BC187R | S/S | CVD | RIBBON | 4 |
| OK366R | B/B | CVD | RIBBON | 4 3/8 |

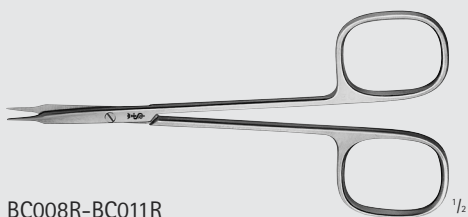

BC008R-BC011R



BC008R



BC009R

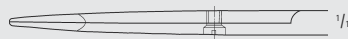

BC010R

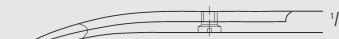

BC011R

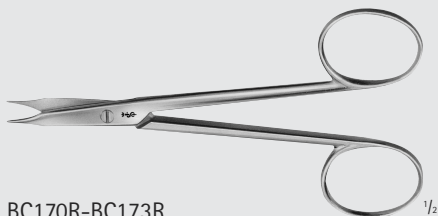

BC170R-BC173R



BC170R

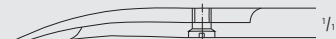

BC171R



BC172R

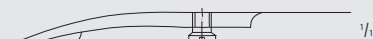

BC173R

STEVENS Tenotomy Scissors

| Catalog Number | Tip | Blade | Handle | Length (in.) |
|----------------|-----|-------|--------|--------------|
| BC008R | S/S | STR | SQUARE | 4 1/2 |
| BC009R | S/S | CVD | SQUARE | 4 1/2 |
| BC010R | B/B | STR | SQUARE | 4 1/2 |
| BC011R | B/B | CVD | SQUARE | 4 1/2 |
| BC170R | S/S | STR | ROUND | 4 3/8 |
| BC171R | S/S | CVD | ROUND | 4 3/8 |
| BC172R | B/B | STR | ROUND | 4 3/8 |
| BC173R | B/B | CVD | ROUND | 4 3/8 |

ENT

MILLIMETERS



ENT

STEVENS Tenotomy Scissors, Fine

| Catalog Number | Tip | Blade | Length (in.) |
|----------------|-----|-------|--------------|
| BC194R | B/B | STR | 5 |
| BC195R | B/B | CVD | 5 |

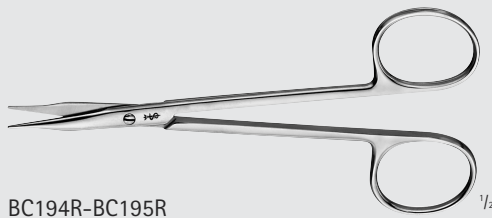

BC194R-BC195R

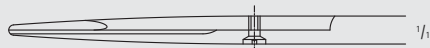

BC194R

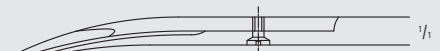

BC195R

STEVENS SuperCut Scissors, Delicate

| Catalog Number | Tip | Blade | Length (in.) |
|----------------|-----|-------|--------------|
| BC904R | B/B | STR | 4 1/8 |
| BC905R | B/B | CVD | 4 1/8 |



BC904R-BC905R



BC904R



BC905R

STEVENS SuperCut Scissors, Delicate

| Catalog Number | Tip | Blade | Length (in.) |
|----------------|-----|-------|--------------|
| BC906R | B/B | STR | 4 3/8 |
| BC907R | B/B | CVD | 4 3/8 |

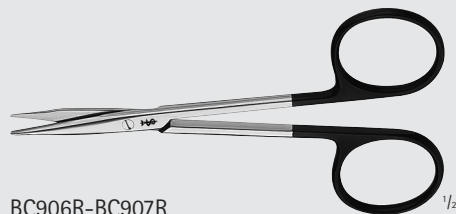

BC906R-BC907R



BC906R



BC907R

REYNOLDS-JAMESON Tenotomy Scissors, Delicate

| Catalog Number | Tip | Blade | Handle | Length (in.) |
|----------------|-----|-------|--------|--------------|
| BC015R | B/B | CVD | SQUARE | 5 1/2 |

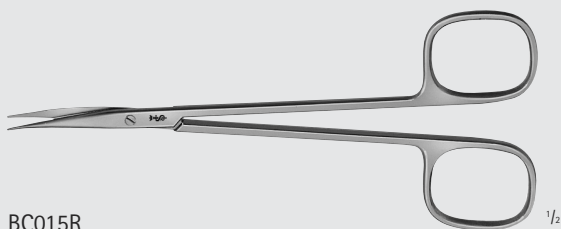

BC015R

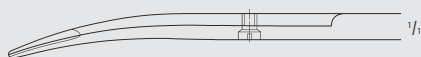

INCHES

Ear/Nose/Throat

Scissors

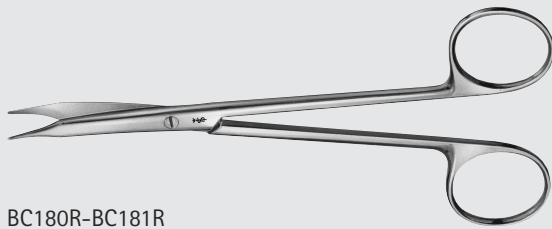

BC180R-BC181R

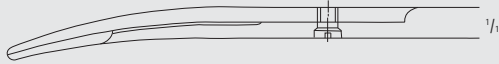

BC180R

REYNOLDS Tenotomy Scissors, Delicate

| Catalog Number | Tip | Blade | Length (in.) |
|----------------|-----|-------|--------------|
| BC180R | B/B | CVD | 5 3/4 |
| BC181R | B/B | CVD | 7 |

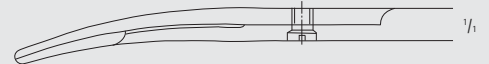

BC181R

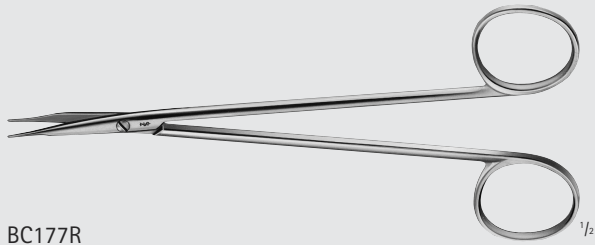

BC177R

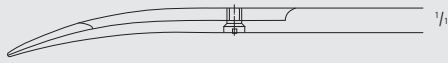

JAMESON Tenotomy Scissors, Delicate

| Catalog Number | Tip | Blade | Length (in.) |
|----------------|-----|-------|--------------|
| BC177R | B/B | CVD | 6 |

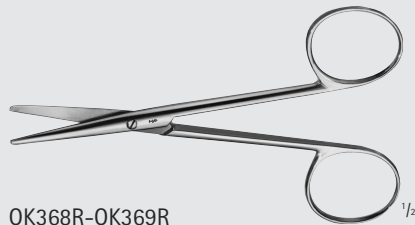

OK368R-OK369R

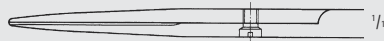

OK368R

COTTLE-KNAPP Plastic Scissors

| Catalog Number | Tip | Blade | Length (in.) |
|----------------|-----|-------|--------------|
| OK368R | B/B | STR | 4 1/8 |
| OK369R | B/B | CVD | 4 1/8 |

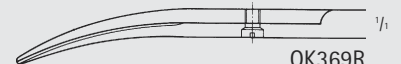

OK369R

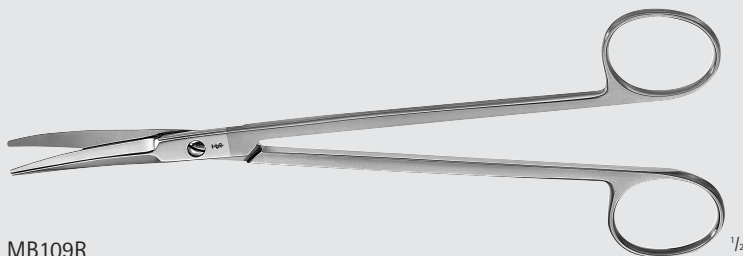

MB109R



KAYE Face Lift Scissors

| Catalog Number | Blade | Length (in.) |
|----------------|-----------|--------------|
| MB109R | CVD, SERR | 7 1/2 |

ENT

MILLIMETERS



MARTIN Cartilage Scissors

| Catalog Number | Blade | Length (in.) |
|----------------|-----------|--------------|
| MB147R | CVD, SERR | 8 |

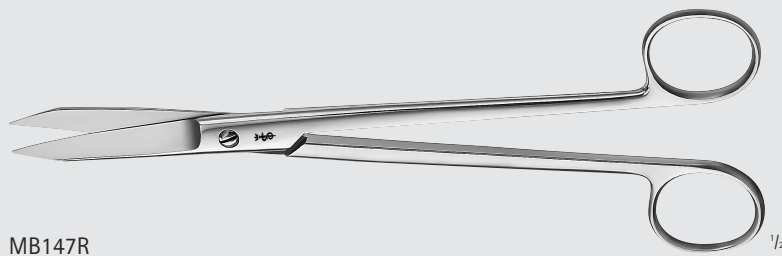

MB147R

1/2



1/1

METZENBAUM-LIPSETT Scissors

| Catalog Number | Blade | Length (in.) |
|----------------|-------|--------------|
| MB150R | CVD | 5 1/2 |

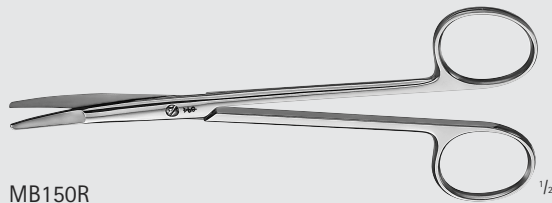

MB150R

1/2



1/1

COTTLE Bulldog Scissors

| Catalog Number | Tip | Blade | Length (in.) |
|----------------|-----|-------|--------------|
| OK374R | B/B | CVD | 4 1/2 |

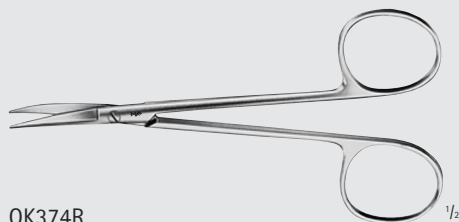

OK374R

1/2

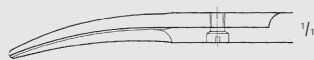

1/1

Strabismus Scissors, Delicate

| Catalog Number | Tip | Blade | Handle | Length (in.) |
|----------------|-----|-------|--------|--------------|
| BC020R | B/B | STR | SQUARE | 4 1/2 |
| BC021R | B/B | CVD | SQUARE | 4 1/2 |

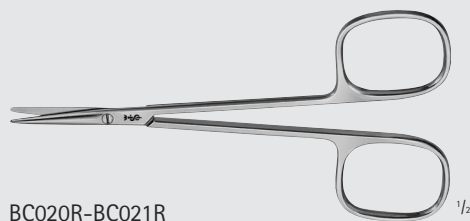

BC020R-BC021R

1/2

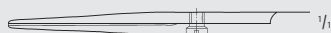

BC020R

1/1

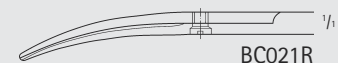

BC021R

1/1

Ear/Nose/Throat

Scissors

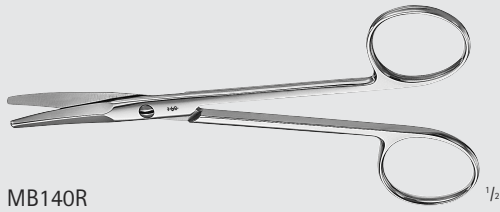

MB140R



FOMON Saber-Back Scissors

| Catalog Number | Tip | Blade | Length (in.) |
|----------------|-----|-----------|--------------|
| MB140R | B/B | CVD, SERR | 5 |

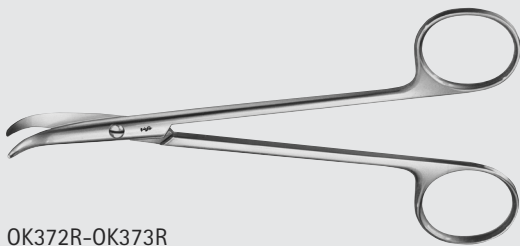

OK372R-OK373R

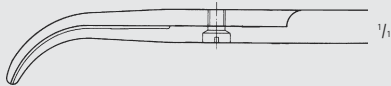

OK372R

FOMON Lower Lateral Scissors

| Catalog Number | Tip | Blade | Length (in.) |
|----------------|-----|---------|--------------|
| OK372R | B/B | HVY-CVD | 5 1/4 |
| OK373R | B/B | HVY-CVD | 4 1/2 |

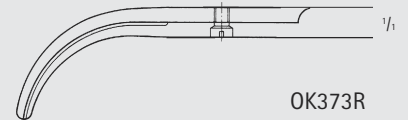

OK373R

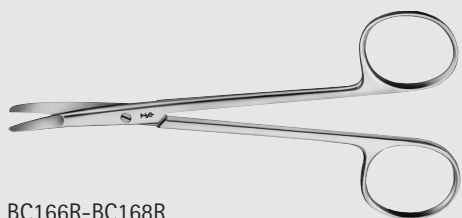

BC166R-BC168R



BC166R

KILNER Scissors

| Catalog Number | Tip | Blade | Length (in.) |
|----------------|------|-------|--------------|
| BC166R | FLAT | CVD | 5 |
| BC168R | FLAT | CVD | 6 |

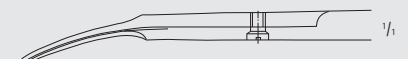

BC168R

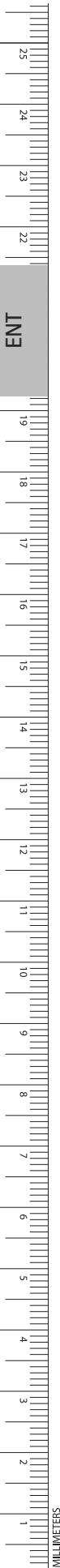

DUROTIP® Tungsten Carbide Scissors

- Excellent cutting accuracy
- Long working life
- Gold-plated rings

DUROTIP TC Delicate Scissors

| Catalog Number | Tip | Blade | Length (in.) |
|----------------|-----|-------|--------------|
| DO208R | S/S | STR | 4 3/4 |
| DO209R | S/S | CVD | 4 3/4 |

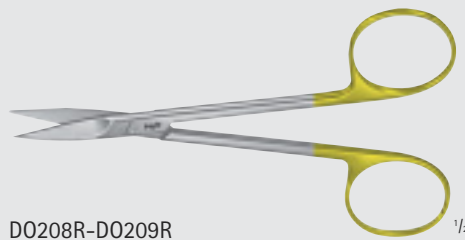

DO208R-DO209R

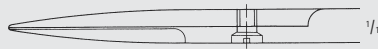

DO208R



DO209R

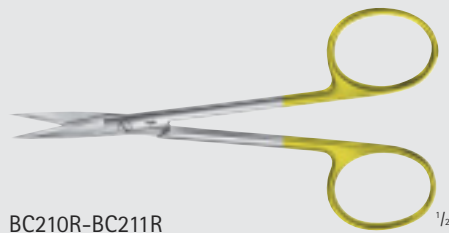

BC210R-BC211R

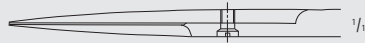

BC210R



BC211R

DUROTIP TC Iris Scissors

| Catalog Number | Tip | Blade | Length (in.) |
|----------------|-----|-------|--------------|
| BC210R | S/S | STR | 4 3/8 |
| BC211R | S/S | CVD | 4 3/8 |

DUROTIP TC GOLDMAN-FOX Tenotomy Scissors

| Catalog Number | Tip | Blade | Length (in.) |
|----------------|-----|-------------|--------------|
| DO250R | S/S | CVD, 1/SERR | 5 1/8 |



DO250R

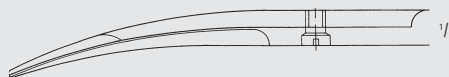

DUROTIP TC Strabismus Scissors

| Catalog Number | Tip | Blade | Length (in.) |
|----------------|-----|-------|--------------|
| BC256R | B/B | STR | 4 1/2 |
| BC257R | B/B | CVD | 4 1/2 |

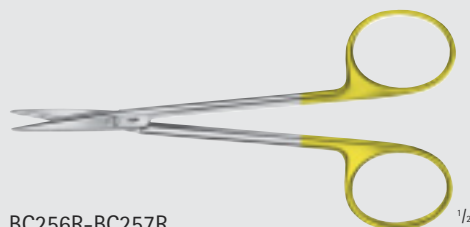

BC256R-BC257R



BC256R

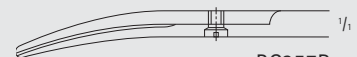

BC257R



Ear/Nose/Throat

DUROTIP® TC Scissors

BC258R-BC259R $\frac{1}{2}$



BC258R $\frac{1}{2}$



BC259R $\frac{1}{2}$

DUROTIP TC BABY-METZENBAUM
Dissecting Scissors, Delicate

| Catalog Number | Tip | Blade | Length (in.) |
|----------------|-----|-------|--------------|
| BC258R | B/B | STR | 5 3/4 |
| BC259R | B/B | CVD | 5 3/4 |



MB207R $\frac{1}{2}$



MB207R $\frac{1}{2}$

DUROTIP TC METZENBAUM
Dissecting Scissors

| Catalog Number | Tip | Blade | Length (in.) |
|----------------|-----|-------|--------------|
| MB207R | S/S | CVD | 5 3/4 |

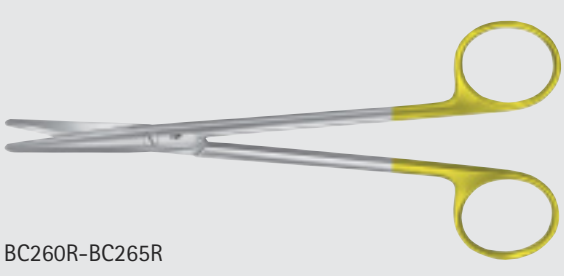

BC260R-BC265R $\frac{1}{2}$

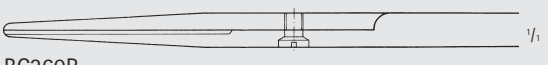

BC260R $\frac{1}{2}$

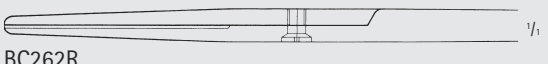

BC262R $\frac{1}{2}$

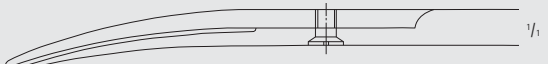

BC265R $\frac{1}{2}$

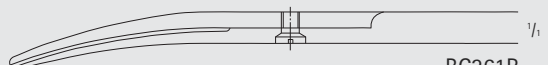

BC261R $\frac{1}{2}$

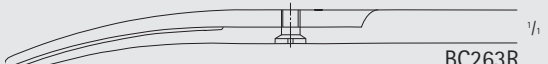

BC263R $\frac{1}{2}$

DUROTIP TC METZENBAUM Dissecting Scissors

| Catalog Number | Tip | Blade | Length (in.) |
|----------------|-----|-------|--------------|
| BC260R | B/B | STR | 5 3/4 |
| BC261R | B/B | CVD | 5 3/4 |
| BC262R | B/B | STR | 7 |
| BC263R | B/B | CVD | 7 |
| BC265R | B/B | CVD | 8 |

DUROTIP TC FOMON Dorsal Scissors

| Catalog Number | Tip | Blade | Length (in.) |
|----------------|-----|-------|--------------|
| MB540R | B/B | 30° | 5 1/4 |

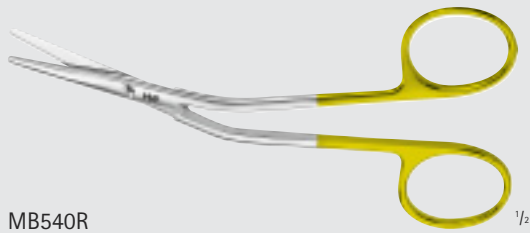

MB540R



1/4

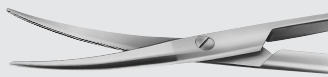

Wavecut

Wavecut scissors have one serrated cutting edge to help prevent tissue from slipping. The W after the item number indicates the scissors are the wavecut style, e.g. BC211W.

DUROTIP TC Iris Wavecut Scissors

| Catalog Number | Tip | Blade | Length (in.) |
|----------------|-----|-------|--------------|
| BC211W | S/S | CVD | 4 3/8 |

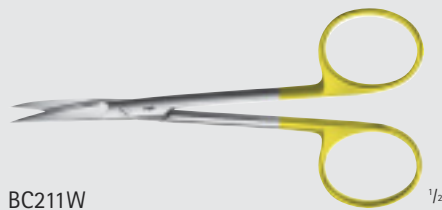

BC211W

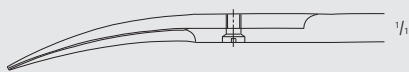

1/4

DUROTIP TC Strabismus Wavecut Scissors

| Catalog Number | Tip | Blade | Length (in.) |
|----------------|-----|-------|--------------|
| BC257W | B/B | CVD | 4 1/2 |

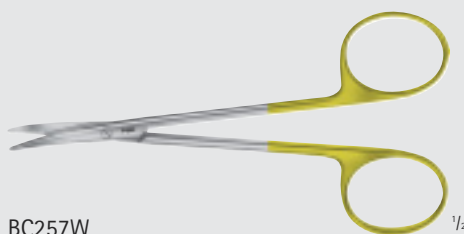

BC257W

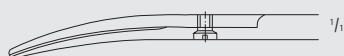

1/4



ENT

INCHES

Ear/Nose/Throat

Noir Supreme Cut Scissors

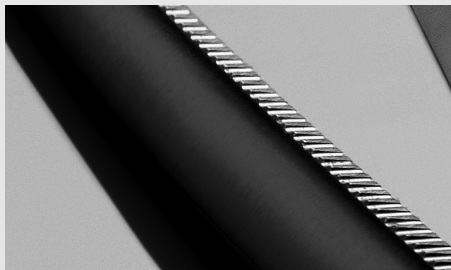

Noir Supreme Cut Scissors

- **Noir**
The combination of the renowned Aesculap tungsten carbide technology with the Aesculap Noir coating results in an extremely high surface hardness and therefore high wear resistance in daily hospital use.
- **Microtome edge**
The extremely sharp cutting edge of the scissors blade facilitates gentle cutting of tissue with minimal use of force.
- **Wavecut prevents tissue from slipping out during the cutting process.**
- **The WB after the item number indicates the Noir scissors are the wavecut style, e.g. BC211WB.**

For more information see our brochure number DOC637.

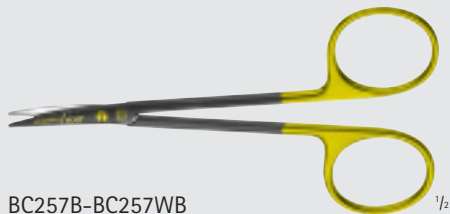

BC257B-BC257WB

1/2



BC257B, BC257WB

1/4

Noir Strabismus Dissecting Scissors

| Catalog Number | Tip | Blade | Length (in.) |
|----------------|-----|-------|--------------|
| BC257B | B/B | CVD | 4 1/2 |
| BC257WB | B/B | CVD | 4 1/2 |



BC259B-BC259WB

1/2



BC259B, BC259WB

1/4

Noir BABY-METZENBAUM Dissecting Scissors

| Catalog Number | Tip | Blade | Length (in.) |
|----------------|-----|-------|--------------|
| BC259B | B/B | CVD | 5 3/4 |
| BC259WB | B/B | CVD | 5 3/4 |



HEYMANN-KNIGHT Nasal Scissors

| Catalog Number | Tip | Blade | Length (in.) |
|----------------|-----|-------|--------------|
| OK350R | B/B | STR | 7 |

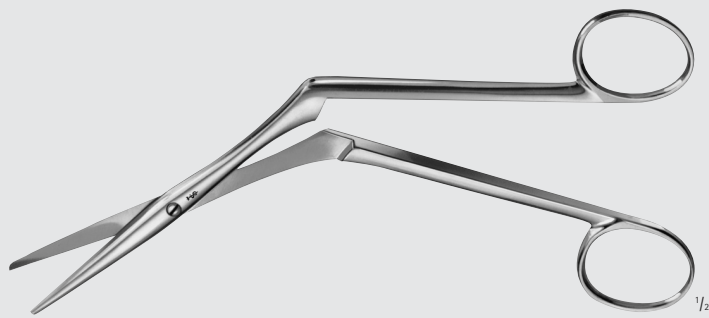

OK350R

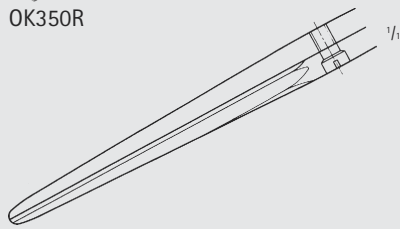

HEYMANN Nasal Scissors

| Catalog Number | Tip | Blade | Length (in.) |
|----------------|-----|-------|--------------|
| OK351R | B/B | STR | 7 1/2 |

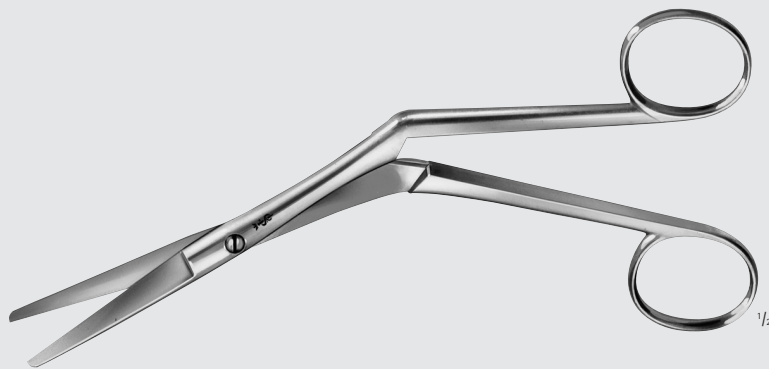

OK351R

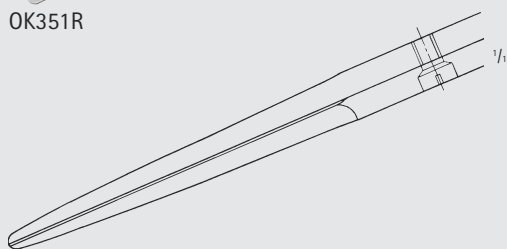

FOMON Nasal Scissors

| Catalog Number | Tip | Blade | Handle | Length (in.) |
|----------------|-----|-------|--------|--------------|
| OK370R | B/B | SERR | ANG | 5 3/4 |

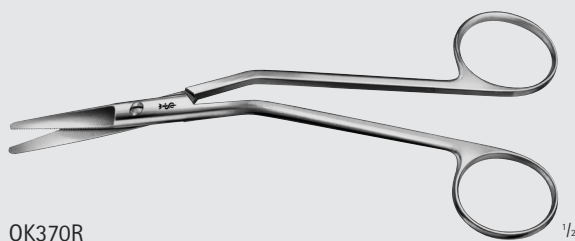

OK370R

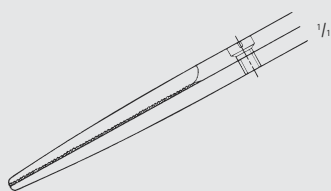

ENT

INCHES

Ear/Nose/Throat

Scissors

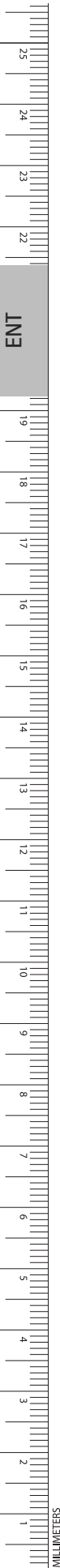

ENT

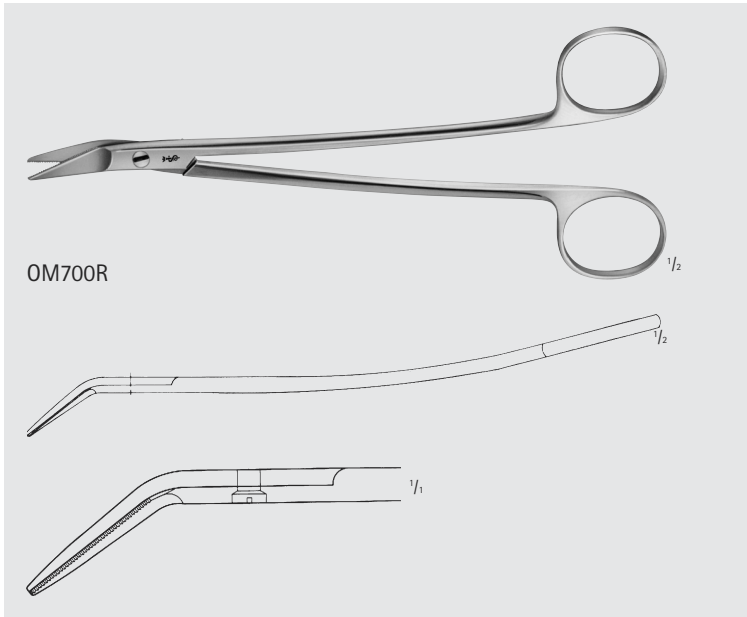

OM700R

DEAN Tonsil Scissors

| Catalog Number | Tip | Blade | Length (in.) |
|----------------|-----|----------|--------------|
| OM700R | B/B | ANG-SERR | 6 3/4 |

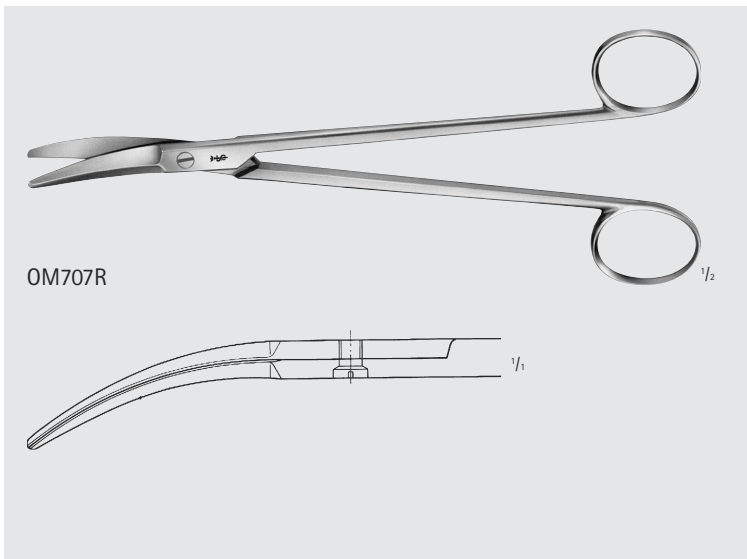

OM707R

BOETTCHER Tonsil Scissors

| Catalog Number | Tip | Blade | Length (in.) |
|----------------|-----|-------|--------------|
| OM707R | B/B | CVD | 7 |

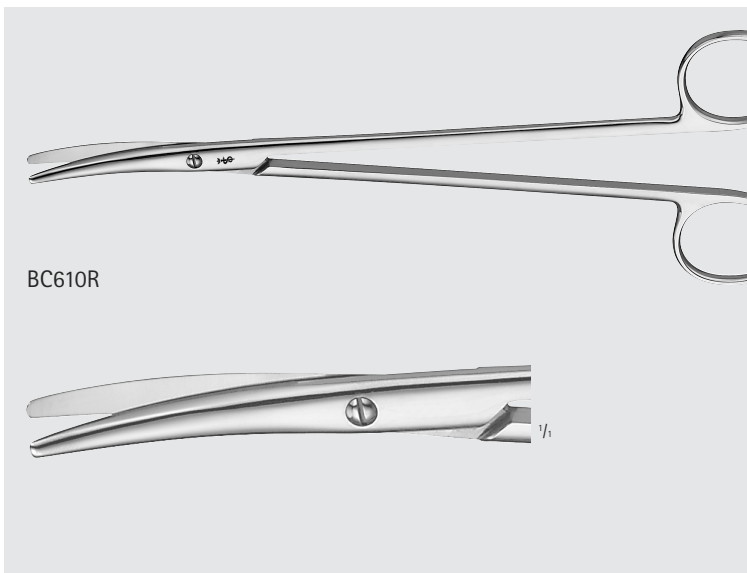

BC610R

LILLIE Scissors

| Catalog Number | Tip | Blade | Length (in.) |
|----------------|-----|-------|--------------|
| BC610R | B/B | CVD | 8 |

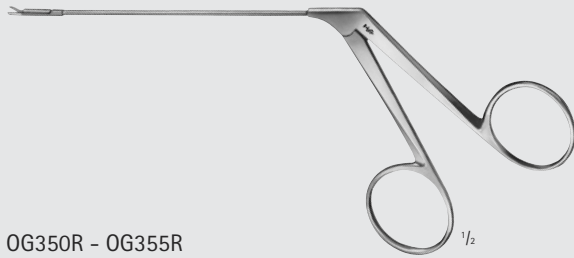

OG350R - OG355R

BELLUCCI Micro Scissors

| Catalog Number | Tip | Blade | Length (in.) |
|----------------|-----|---------|--------------|
| OG350R | S/S | STR | 3 1/4 |
| OG351R | B/B | ANG-UP | 3 1/4 |
| OG352R | S/S | CVD-LFT | 3 1/4 |
| OG353R | S/S | CVD-RT | 3 1/4 |
| OG355R | S/S | CVD-UP | 3 1/4 |



OG350R



OG351R



OG352R



OG353R



OG355R

Micro Laryngeal Scissors

| Catalog Number | Tip | Blade | Length (in.) |
|----------------|-----|---------|--------------|
| OP310R | S/S | STR | 10 |
| OP311R | S/S | CVD-LFT | 10 |
| OP312R | S/S | CVD-RT | 10 |
| OP313R | S/S | ANG-UP | 10 |

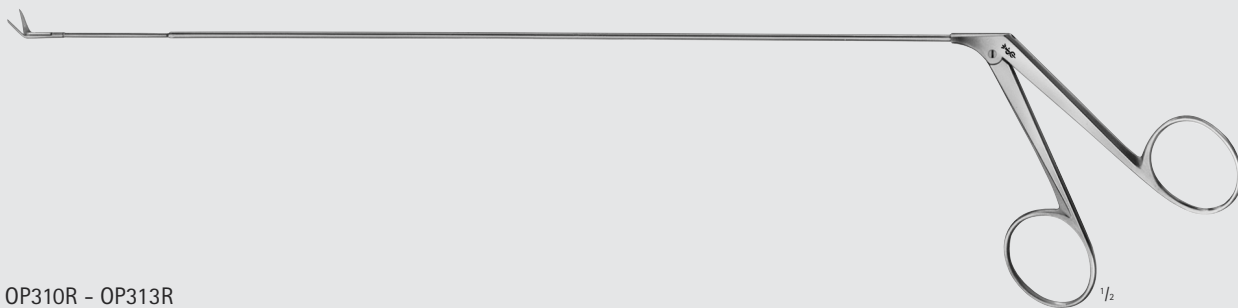

OP310R - OP313R



OP310R



OP311R



OP312R



OP313R

Ear/Nose/Throat

Needles

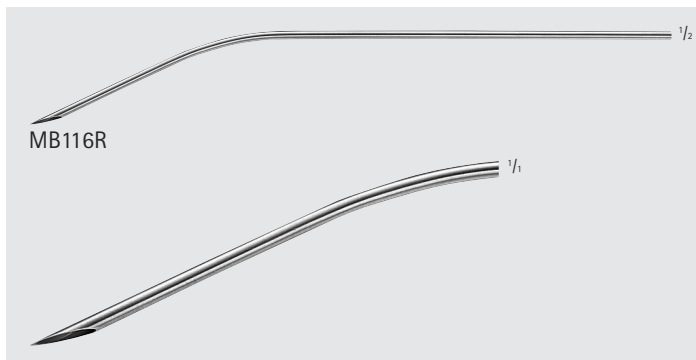

MB116R

DINGMANN Malleable Passing Needle

| Catalog Number | Tip | Length (in.) |
|----------------|-----|--------------|
| MB116R | CVD | 6 3/4 |

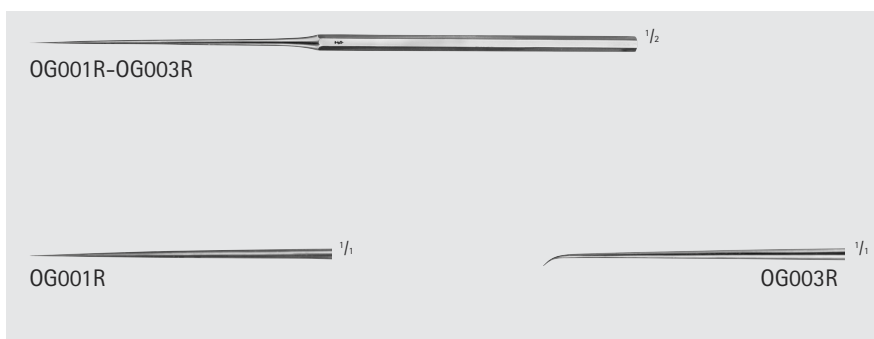

OG001R-OG003R

OG001R

OG003R

OG002R

Micro Needle

| Catalog Number | Tip | Blade Shape | Length (in.) |
|----------------|----------|-------------|--------------|
| OG001R | SHARP-PT | STR | 6 1/4 |
| OG002R | SHARP-PT | CVD | 6 1/4 |
| OG003R | SHARP-PT | HVY-CVD | 6 1/4 |

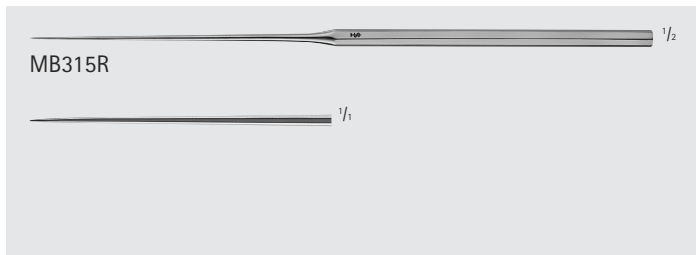

MB315R

HOUSE-BARBARA Shattering Needle

| Catalog Number | Length (in.) |
|----------------|--------------|
| MB315R | 6 1/2 |

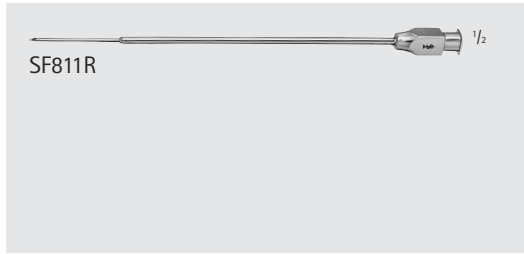

SF811R

Tonsil Needle W/Luer Lock Attachment

| Catalog Number | Tip Size (mm) | Length (mm) |
|----------------|---------------|-------------|
| SF811R | DIAM. 0.8 | 75 |

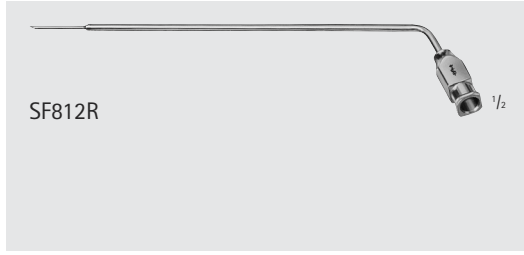

SF812R

Septum Needle W/Luer Lock Attachment

| Catalog Number | Tip Size (mm) | Length (mm) |
|----------------|---------------|-------------|
| SF812R | DIAM. 0.8 | 90 |

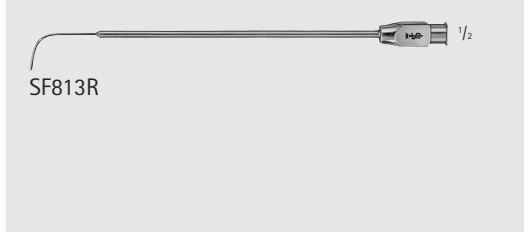

SF813R

Tonsil Needle W/Luer Lock Attachment

| Catalog Number | Tip Size (mm) | Length (mm) |
|----------------|---------------|-------------|
| SF813R | DIAM. 0.8 | 75 |

Ear/Nose/Throat

Tissue, Dressing & Sponge Forceps

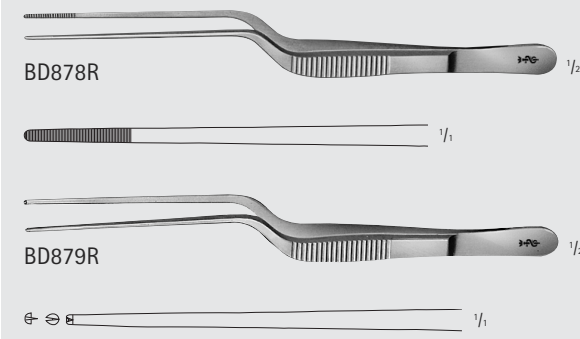

LUCAE Bayonet Forceps

| Catalog Number | Tip | Teeth | Length (in.) |
|----------------|------|-------|--------------|
| BD878R | SERR | | 5 1/2 |
| BD879R | | 1 x 2 | 5 1/2 |

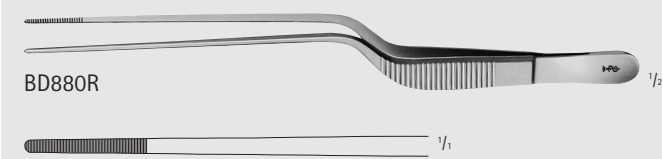

JANSEN Bayonet Forceps

| Catalog Number | Tip | Length (in.) |
|----------------|------|--------------|
| BD880R | SERR | 6 1/4 |

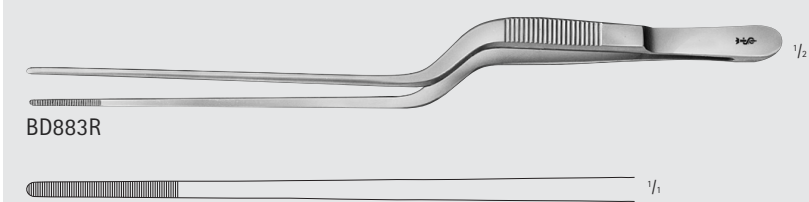

GRUENWALD Bayonet Forceps

| Catalog Number | Tip | Length (in.) |
|----------------|------|--------------|
| BD883R | SERR | 8 |

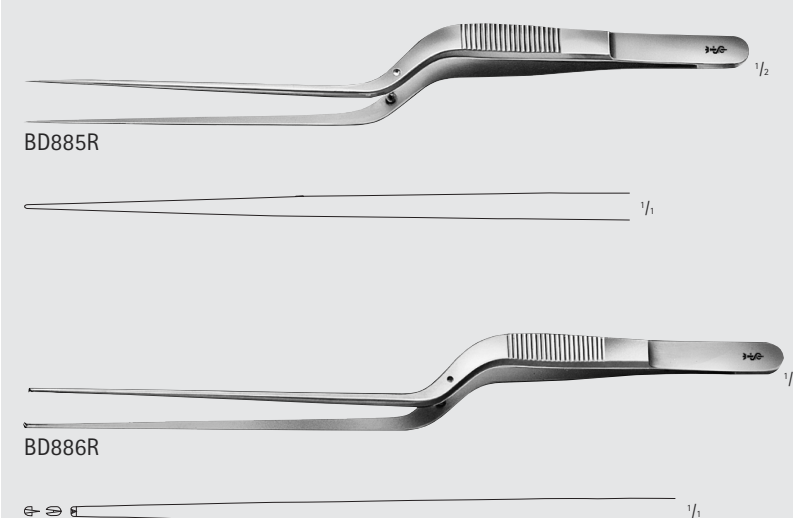

Bayonet Forceps

| Catalog Number | Tip | Teeth | Length (in.) |
|----------------|-------------|-------|--------------|
| BD885R | SMOOTH | | 7 1/4 |
| BD886R | BAYO-SHAPED | 1 x 2 | 8 |



INCHES

Ear/Nose/Throat

Tissue, Dressing & Sponge Forceps

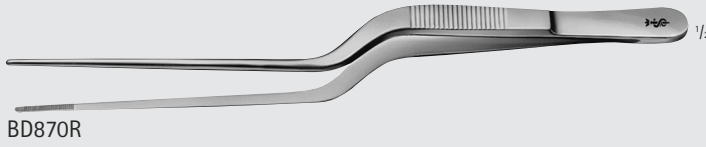

ADSON Bayonet Forceps

| Catalog Number | Tip | Length (in.) |
|----------------|------|--------------|
| BD870R | SERR | 7 |



BROWN-BAHNSON Bayonet Forceps

| Catalog Number | Tip | Length (in.) |
|----------------|------|--------------|
| BD876R | SERR | 6 |



TROELTSCH Bayonet Forceps

| Catalog Number | Tip | Length (in.) |
|----------------|----------|--------------|
| BD900R | ANG/SERR | 4 |
| BD910R | ANG/SERR | 5 1/2 |



Ear/Nose/Throat

Tissue, Dressing & Sponge Forceps



BD904R

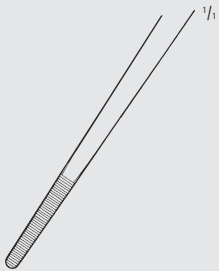

WILDE Forceps

| Catalog Number | Tip | Length (in.) |
|----------------|----------|--------------|
| BD904R | ANG/SERR | 4 1/2 |



OL010R

COTTLE Columella Clamp

| Catalog Number | Length (in.) |
|----------------|--------------|
| OL010R | 4 |



INCHES

Ear/Nose/Throat

Tissue, Dressing & Sponge Forceps

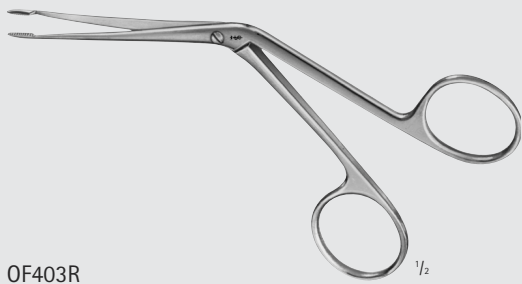

OF403R



OF405R



HARTMANN Ear Forceps

| Catalog Number | Tip | Length (in.) |
|----------------|-----|--------------|
| OF403R | DEL | 5 |
| OF405R | HVY | 5 |

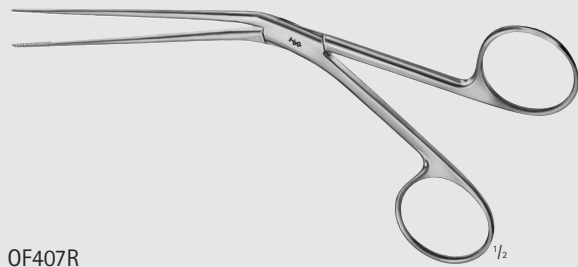

OF407R



TILLEY Ear Forceps

| Catalog Number | Tip | Length (in.) |
|----------------|-------|--------------|
| OF407R | X-DEL | 5 1/2 |

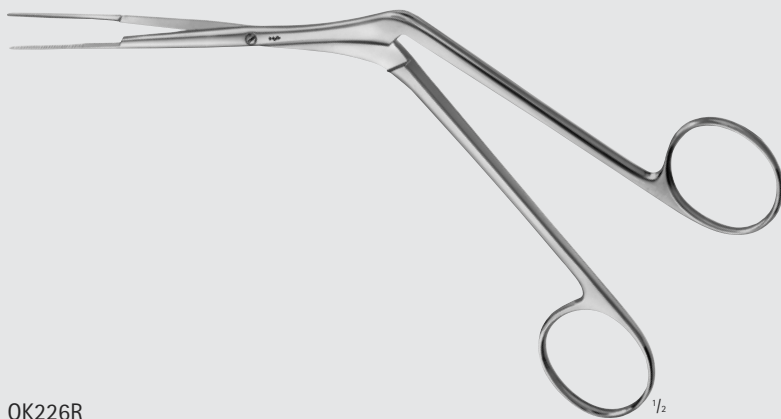

OK226R



WEST Nasal Dressing Forceps

| Catalog Number | Length (in.) |
|----------------|--------------|
| OK226R | 8 |

Ear/Nose/Throat

Tissue, Dressing & Sponge Forceps

HARTMANN Nasal Dressing Forceps

| Catalog Number | Length (in.) |
|----------------|--------------|
| OK242R | 7 |
| OK243R | 8 1/4 |

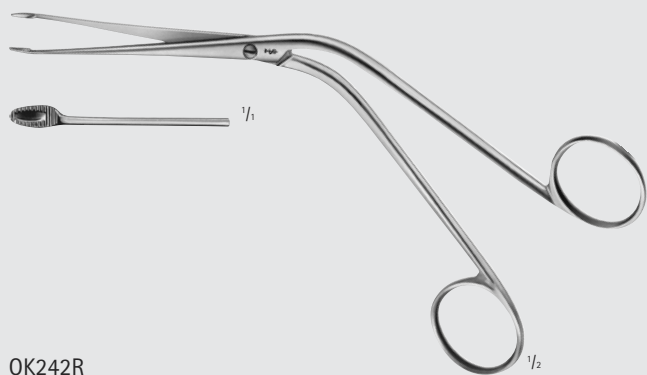

OK242R

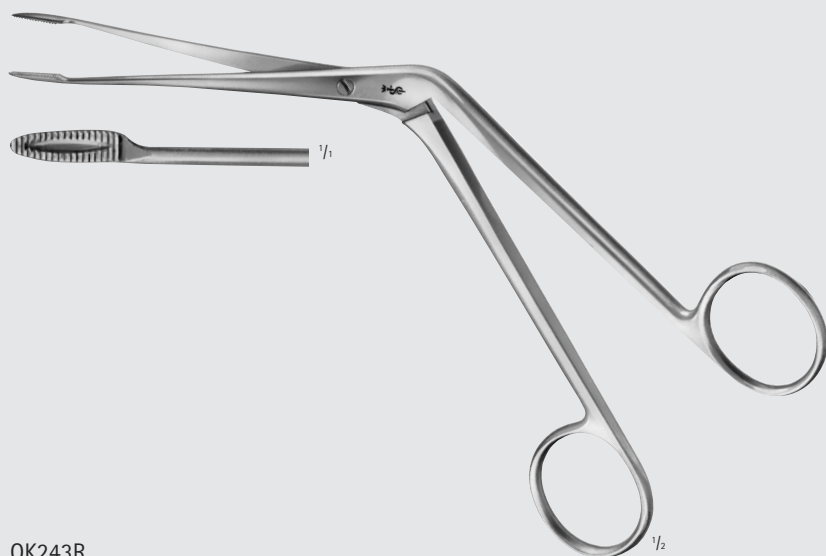

OK243R

HARTMANN Alligator Forceps

| Catalog Number | Length (in.) |
|----------------|--------------|
| OK245R | 7 1/2 |

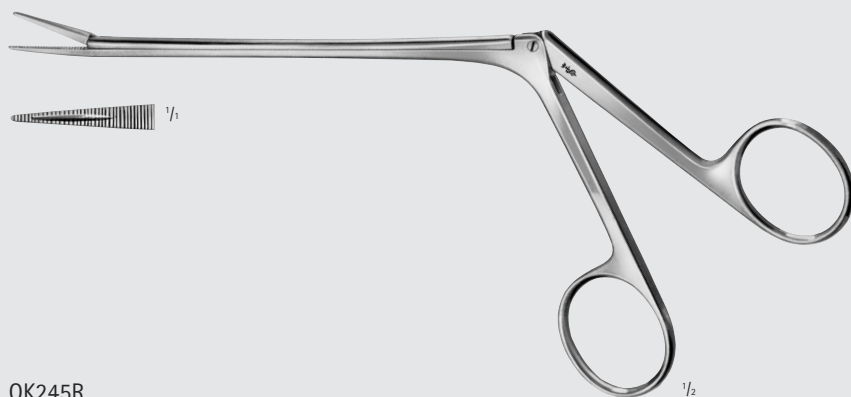

OK245R



INCHES

Ear/Nose/Throat

Forceps

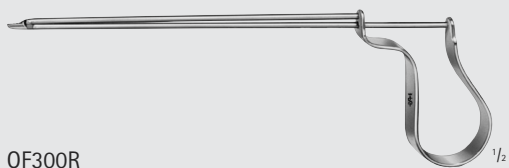

OF300R



QUIRE Ear Forceps, F/Foreign Body Removal

| Catalog Number | Length (in.) |
|----------------|--------------|
| OF300R | 3 1/2 |



OF303R



BUCK Ear Forceps

| Catalog Number | Length (in.) |
|----------------|--------------|
| OF303R | 3 1/2 |

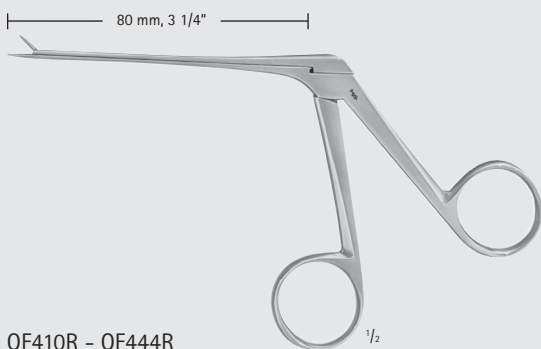

OF410R - OF444R



OF410R

OF414R



OF442R

OF444R

HARTMANN-WULLSTEIN Ear Forceps

| Catalog Number | Tip Size (mm) | Jaw | Length (in.) |
|----------------|---------------|-----------|--------------|
| OF410R | 0.5 x 6 | STR, SERR | 3 1/4 |
| OF414R | 1 x 8 | STR, SERR | 3 1/4 |
| OF442R | 1 | STR, CUP | 3 1/4 |
| OF444R | 2 | STR, CUP | 3 1/4 |

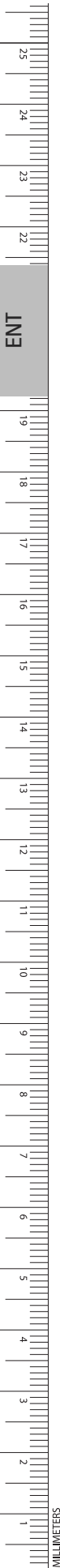

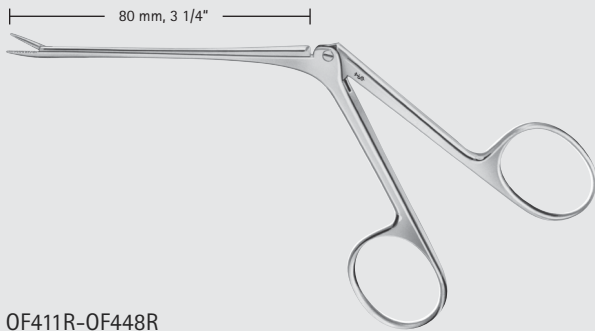

HARTMANN Ear Forceps

| Catalog Number | Tip Size (mm) | Jaw | Length (in.) |
|----------------|---------------|----------------|--------------|
| OF411R | 1 x 8 | STR, SERR | 3 1/4 |
| OF420R | 1 x 8 | STR, 1x2 TEETH | 3 1/4 |
| OF425R | 2 x 7 | STR, OVAL | 3 1/4 |
| OF438R | 2.0 | STR, CUP | 3 1/4 |
| OF439R | 2.5 | STR, CUP | 3 1/4 |
| OF440R | 3.0 | STR, CUP | 3 1/4 |
| OF448R | 2.0 | ANG, CUP | 3 1/4 |

OF411R-OF448R

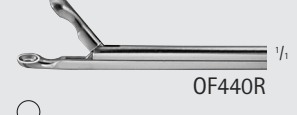
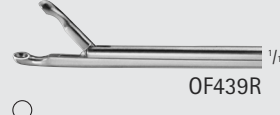
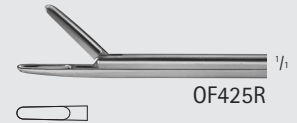
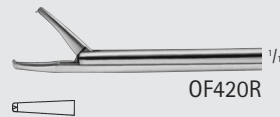

HENCKEL Ear Forceps

| Catalog Number | Tip Size (mm) | Jaw | Length (in.) |
|----------------|---------------|------------------|--------------|
| OF431R | 2.5 x 5.0 | FLAT, OVAL SPOON | 3 1/4 |

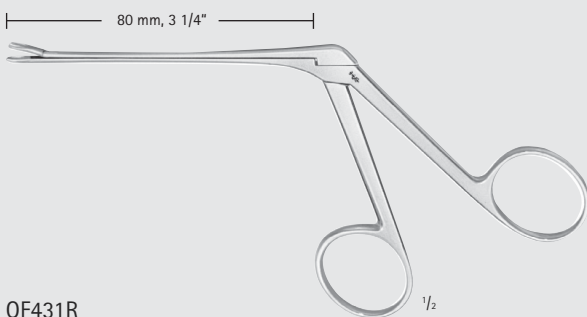

OF431R



INCHES

Ear/Nose/Throat

Forceps

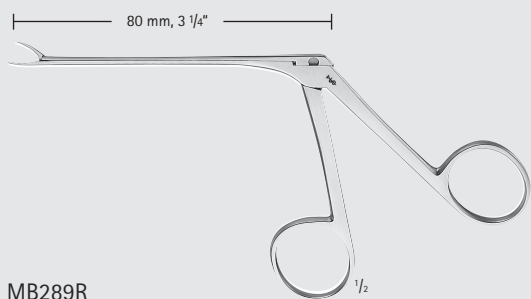

MB289R



WEINGARTNER Ear Forceps

| Catalog Number | Jaw | Length (in.) |
|----------------|------|--------------|
| MB289R | SERR | 3 1/8 |

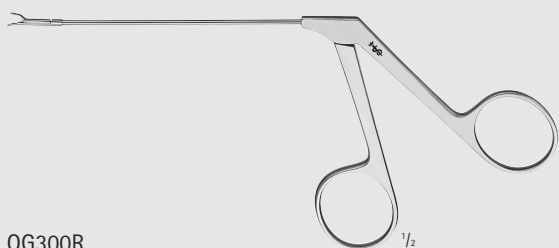

OG300R



DIETER Malleus Nipper

| Catalog Number | Tip | Length (in.) |
|----------------|-----------------|--------------|
| OG300R | UPWARDS CUTTING | 3 1/4 |



OG343R-OG345R



OG343R



OG346R



OG344R

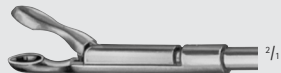

OG348R



OG345R

WULLSTEIN Micro Cup Forceps

| Catalog Number | Tip Size (mm) | Jaw | Length (in.) |
|----------------|---------------|---------|--------------|
| OG343R | 0.8 x 1.3 | CVD-LFT | 3 1/4 |
| OG346R | 1 | STR | 3 1/4 |
| OG344R | 0.8 x 1.3 | CVD-RT | 3 1/4 |
| OG348R | 1.7 x 2.5 | STR | 3 1/4 |
| OG345R | 0.8 x 1.3 | STR | 3 1/4 |

ENT

MILLIMETERS

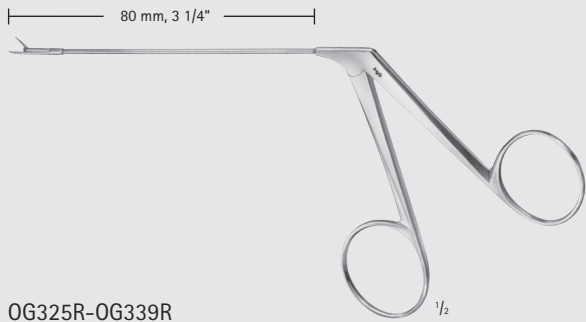

OG325R-OG339R

Alligator Forceps

| Catalog Number | Tip Size (mm) | Jaw | Length (in.) |
|----------------|---------------|-------------|--------------|
| OG325R | 1.5 x 6.0 | STR | 3 1/4 |
| OG332R | 0.8 x 3.5 | ANG-DWN 45° | 3 1/4 |
| OG335R | 1 x 5 | STR | 3 1/4 |
| OG330R | 0.8 x 3.5 | STR | 3 1/4 |
| OG331R | 0.8 x 3.5 | ANG-UP 55° | 3 1/4 |
| OG338R | 1 x 5 | CVD-LFT | 3 1/4 |
| OG339R | 1 x 5 | CVD-RT | 3 1/4 |

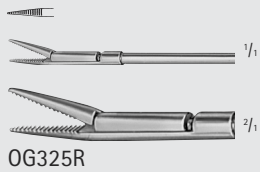

OG325R

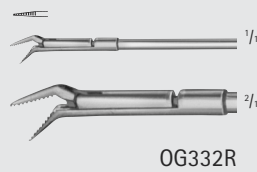

OG332R

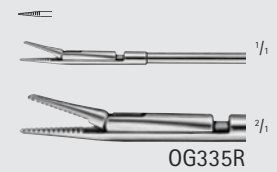

OG335R

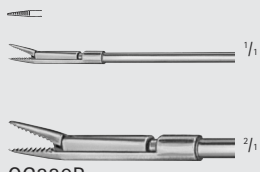

OG330R

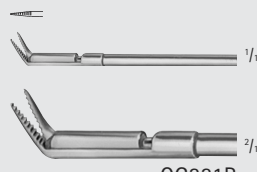

OG331R

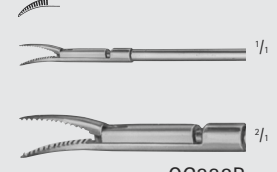

OG338R

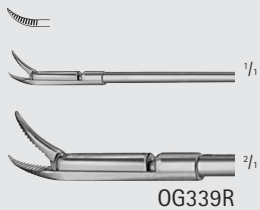

OG339R



INCHES

Ear/Nose/Throat

Forceps

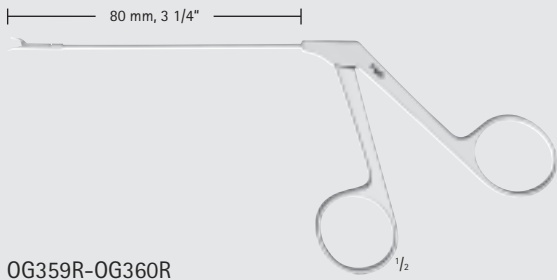

OG359R-OG360R



OG359R



OG360R

MC GEE Wire Forceps

| Catalog Number | Tip Size (mm) | Blade | Length (in.) |
|----------------|---------------|---------|--------------|
| OG359R | 3.5 | DWN-CVD | 3 1/4 |
| OG360R | 5 | DWN-CVD | 3 1/4 |

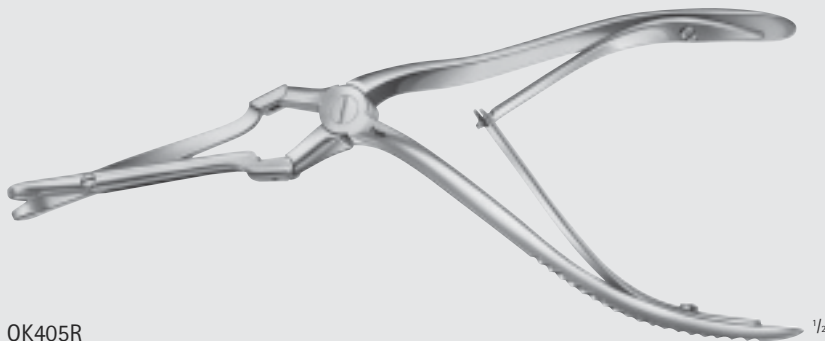
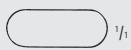

JANSEN-MIDDLETON Septum Forceps

| Catalog Number | Length (in.) |
|----------------|--------------|
| OK400R | 8 |
| OK405R | 8 1/4 |

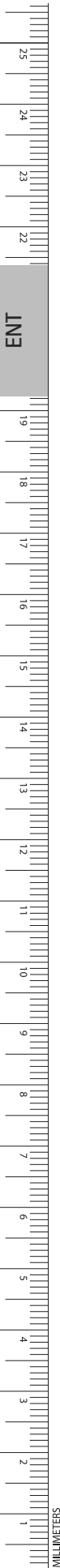



HEYMANN-KNIGHT Septum Forceps

| Catalog Number | Length (in.) |
|----------------|--------------|
| OK422R | 7 1/2 |

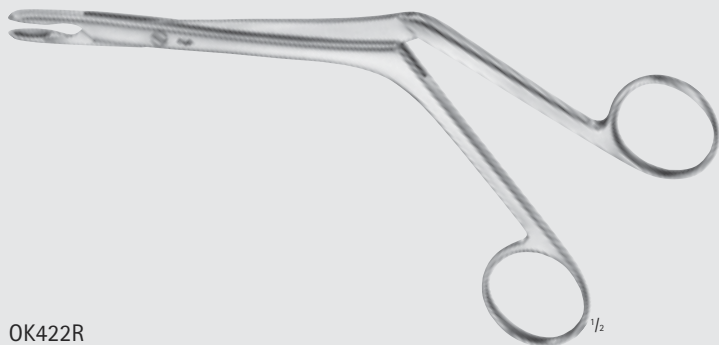

OK422R

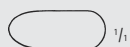

BRUENINGS Septum Forceps

| Catalog Number | Size | Length (in.) |
|----------------|---------|--------------|
| OK440R | SMALL | 7 1/2 |
| OK441R | MEDIUM | 7 1/2 |
| OK442R | LARGE | 7 1/2 |
| OK443R | X-LARGE | 7 1/2 |



OK440R-OK443R



OK440R



OK442R



OK441R



OK443R

ASH Septum Forceps

| Catalog Number | Jaw | Length (in.) |
|----------------|-----|--------------|
| OL470R | STR | 8 3/4 |



OL470R



Ear/Nose/Throat

Forceps

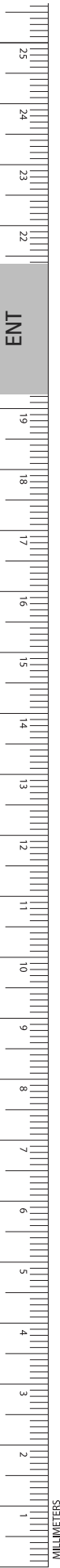

WALSHAM Septum Forceps

| Catalog Number | Jaw | Length (in.) |
|----------------|-----|--------------|
| OL471R | RT | 8 1/4 |
| OL472R | LFT | 8 1/4 |

OL471R-OL472R $\frac{1}{2}$

OL471R $\frac{1}{4}$

OL472R $\frac{1}{4}$

COTTLE-WALSHAM Septum Forceps

| Catalog Number | Jaw | Length (in.) |
|----------------|-----|--------------|
| OL473R | STR | 8 3/4 |

OL473R $\frac{1}{2}$

$\frac{1}{4}$

Septum Morselizer Forceps, W/Removable Guard

| Catalog Number | Length (in.) |
|----------------|--------------|
| OL474R | 8 |

OL474R $\frac{1}{2}$

$\frac{1}{4}$

NEGUS Tonsil Forceps

| Catalog Number | Jaw | Length (in.) |
|----------------|-----------|--------------|
| BH951R | HVY-CVD | 7 1/2 |
| BH952R | X-HVY-CVD | 7 1/2 |

BH951R-BH952R $\frac{1}{2}$

BH951R $\frac{1}{4}$

BH952R $\frac{1}{4}$

MUSEUX Tonsil Forceps

| Catalog Number | Tip | Length (in.) |
|----------------|-------|--------------|
| OM602R | 2 x 2 | 8 |

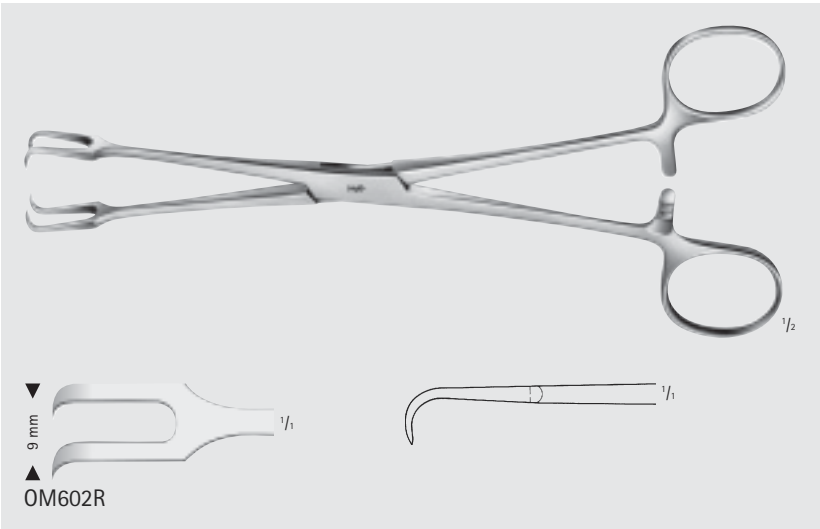

COLVER Tonsil Seizing Forceps

| Catalog Number | Length (in.) |
|----------------|--------------|
| OM611R | 8 |

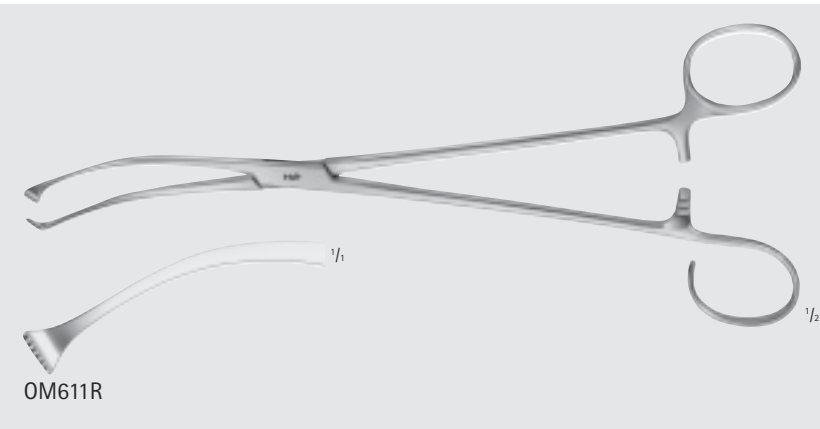

WHITE Tonsil Seizing Forceps

| Catalog Number | Length (in.) |
|----------------|--------------|
| OM612R | 7 |
| OM613R | 9 1/4 |

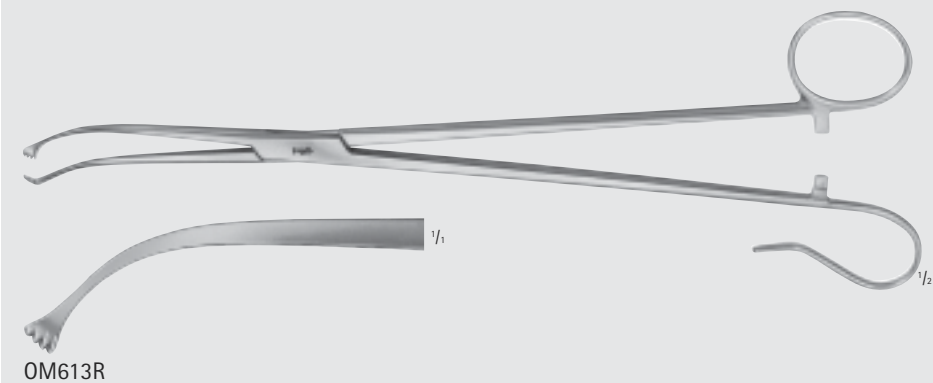
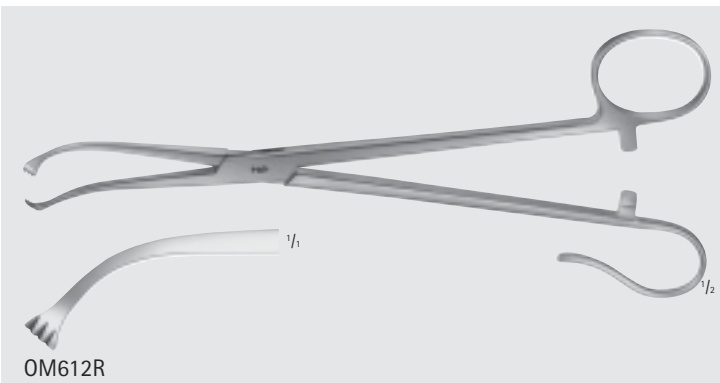

Ear/Nose/Throat

Forceps

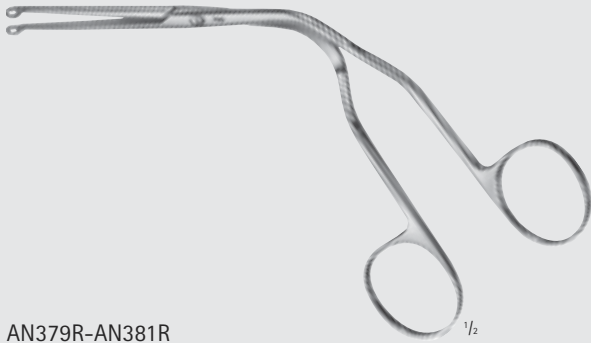

AN379R-AN381R



AN379R



AN380R



AN381R

MAGILL Forceps

| Catalog Number | Size | Length (in.) |
|----------------|-----------|--------------|
| AN379R | INFANT | 6 |
| AN380R | PEDIATRIC | 8 |
| AN381R | ADULT | 10 |

Micro Laryngeal Forceps

| Catalog Number | Jaw | Length (in.) |
|----------------|---------|--------------|
| OP300R | STR | 10 |
| OP301R | CVD-LFT | 10 |
| OP302R | CVD-RT | 10 |

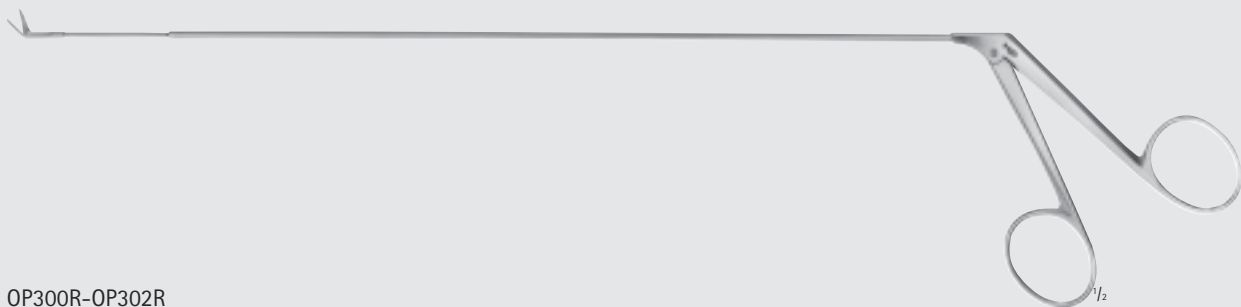

OP300R-OP302R

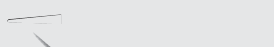

OP300R

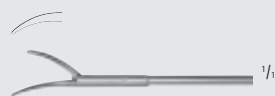

OP301R

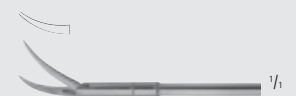

OP302R

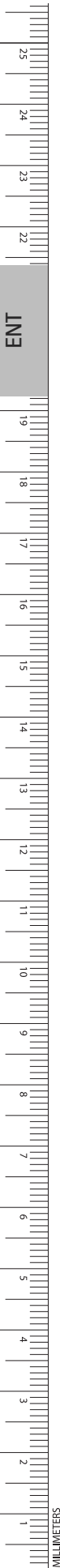

Micro Laryngeal Cup Forceps

| Catalog Number | Tip Size (mm) | Jaw | Length (in.) |
|----------------|---------------|---------|--------------|
| OP304R | 2 | STR | 10 |
| OP305R | 2 | ANG-LFT | 10 |
| OP306R | 2 | ANG-RT | 10 |
| OP307R | 2 | ANG-UP | 10 |

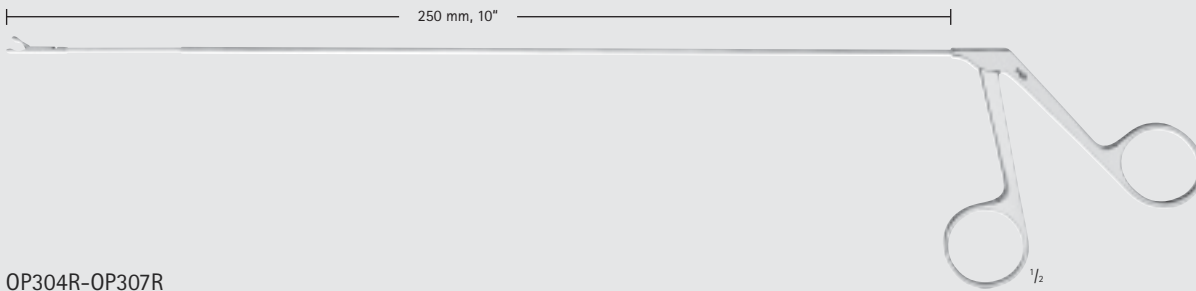

OP304R-OP307R



OP304R

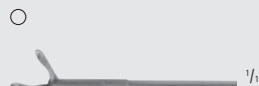

OP305R

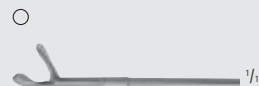

OP306R



OP307R

SCHNIDT Tonsil Forceps

| Catalog Number | Handle | Jaw | Length (in.) |
|----------------|-----------|---------|--------------|
| BH957R | CLSD RING | SLT-CVD | 7 1/4 |
| BH959R | CLSD RING | CVD | 7 1/4 |
| BH961R | OPEN RING | SLT-CVD | 7 1/4 |
| BH963R | OPEN RING | CVD | 7 1/4 |

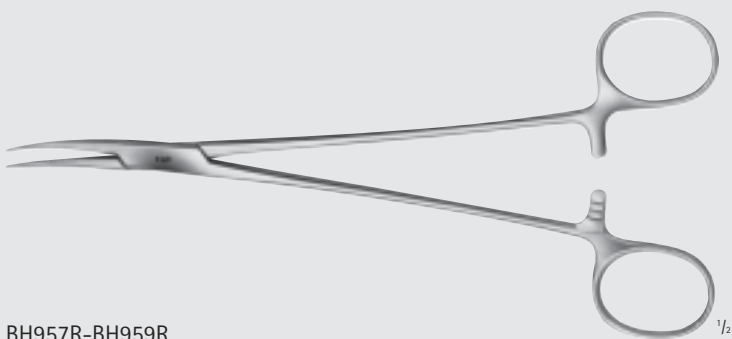

BH957R-BH959R



BH957R



BH959R

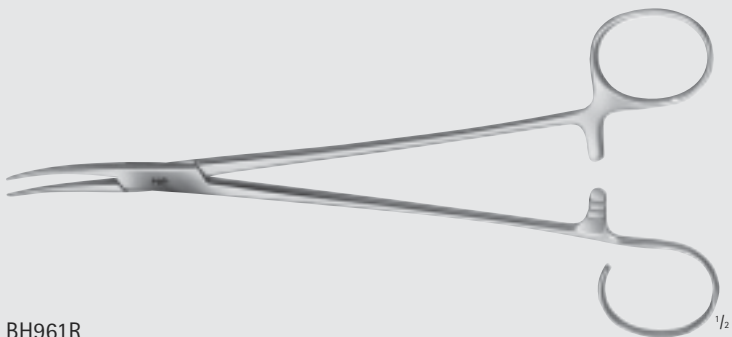

BH961R



BH961R



BH963R



INCHES

Ear/Nose/Throat

Forceps



MC HENRY Tonsil Artery & Sponge-Holding Forceps

| Catalog Number | Jaw | Length (in.) |
|----------------|-----|--------------|
| MB533R | CVD | 8 |

MB533R $\frac{1}{2}$

NISSEN Delicate Tonsil Forceps

| Catalog Number | Jaw | Length (in.) |
|----------------|-----|--------------|
| BH199R | CVD | 7 1/4 |

BH199R $\frac{1}{2}$

$\frac{1}{4}$

ADSON Delicate Tonsil Forceps

| Catalog Number | Jaw | Length (in.) |
|----------------|-----|--------------|
| BH200R | STR | 7 1/4 |
| BH201R | CVD | 7 1/4 |

BH200R-BH201R $\frac{1}{2}$

BH200R $\frac{1}{4}$

BH201R $\frac{1}{4}$

Tonsil Clamp

| Catalog Number | Jaw | Length (in.) |
|----------------|-----|--------------|
| MB103R | CVD | 14 1/2 |

MB103R $\frac{1}{2}$

$\frac{1}{4}$



SHAMBAUGH Fenestra Hook

| Catalog Number | Tip Size (mm) | Angle | Length (in.) |
|----------------|---------------|-------|--------------|
| OG011R | 0.4 | 90° | 6 1/4 |
| OG012R | 0.6 | 90° | 6 1/4 |
| OG013R | 0.8 | 90° | 6 1/4 |
| OG014R | 1.0 | 90° | 6 1/4 |



Prong Micro Hook

| Catalog Number | Tip Size (mm) | Blade End | Length (in.) |
|----------------|-----------------------|-----------|--------------|
| MB885R | 1 | SHARP | 5 5/8 |
| MB886R | 2 | SHARP | 5 5/8 |
| MB887R | 2 | BLUNT | 5 5/8 |
| MB888R | 2 MM BETWN TIP | SHARP | 5 5/8 |
| MB889R | 5 MM BETWN TIP | SHARP | 5 5/8 |
| MB890R | 7 MM BETWN TIP | SHARP | 5 5/8 |
| MB891R | 10 MM BETWN TIP | SHARP | 5 5/8 |



Ear/Nose/Throat

Hooks



OF277R-OF279R

LUCAE Ear Hook, Buttoned

| Catalog Number | Size | Length (in.) |
|----------------|--------|--------------|
| OF277R | SMALL | 5 1/2 |
| OF278R | MEDIUM | 5 1/2 |
| OF279R | LARGE | 5 1/2 |

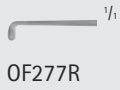

OF277R

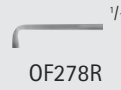

OF278R

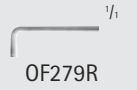

OF279R



OF285R-OF282R

WAGENER Ear Hook, Buttoned

| Catalog Number | Size | Length (in.) |
|----------------|---------|--------------|
| OF285R | X-SMALL | 6 |
| OF284R | SMALL | 6 |
| OF283R | MEDIUM | 6 |
| OF282R | LARGE | 6 |

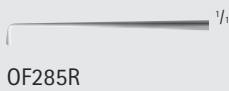

OF285R

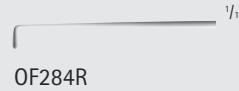

OF284R



OF283R

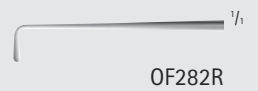

OF282R



OL201R

LANGE Fistul Hook

| Catalog Number | Tip | Length (in.) |
|----------------|-------|--------------|
| OL201R | BLUNT | 9 |

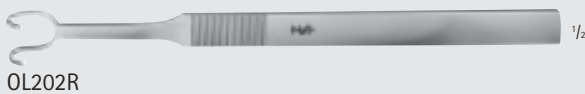

OL202R

FOMON Retractor

| Catalog Number | Tip | Blade End | Length (in.) |
|----------------|-------|-----------|--------------|
| OL202R | BLUNT | 2 PRONGS | 5 3/4 |

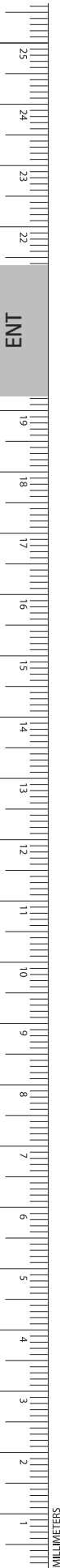
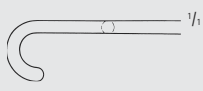

Ear/Nose/Throat

Hooks, Hand Held Retractors

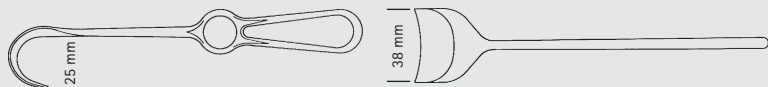

Dimensions for blade size of retractors
 1st number = depth Example: 25 x 38 mm
 2nd number = width

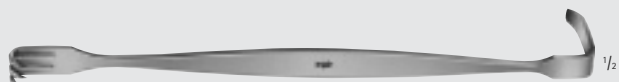

BT006R-BT007R

BABY-SENN-MILLER Retractor

| Catalog Number | Tip | Blade End | Blade Size (mm) | Length (in.) |
|----------------|-------|-----------|-----------------|--------------|
| BT006R | SHARP | 3 PRONGS | 8 x 7 / 22 x 7 | 6 |
| BT007R | BLUNT | 3 PRONGS | 8 x 7 / 22 x 7 | 6 |



BT006R

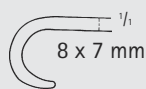

BT007R

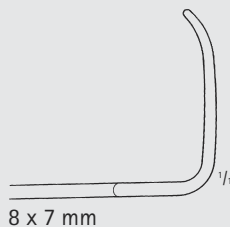

BT008R

SENN-MILLER Retractor

| Catalog Number | Tip | Blade End | Length (in.) |
|----------------|-------|-----------|--------------|
| BT008R | SHARP | 3 PRONGS | 6 1/2 |

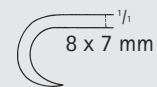

8 x 7 mm

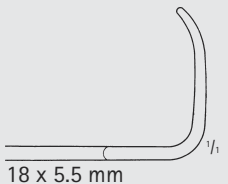

18 x 5.5 mm



OL207R

CONVERSE Double Hook

| Catalog Number | Blade Size (mm) | Length (in.) |
|----------------|-----------------|--------------|
| OL207R | 7 x 12 / 8 x 12 | 4 3/4 |



INCHES

Ear/Nose/Throat

Hooks

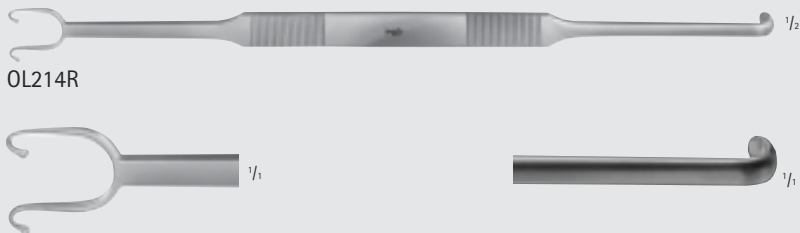

OL214R

COTTLE Nasal Retractor

| Catalog Number | Tip | Blade Size (mm) | Length (in.) |
|----------------|-------------|------------------|--------------|
| OL214R | BLUNT/BLUNT | 12 x 5 / 4 x 4.5 | 8 |



OL203R-OL204R



OL203R



OL204R

COTTLE Retractor

| Catalog Number | Tip | Length (in.) |
|----------------|-------------|--------------|
| OL203R | BLUNT/SHARP | 5 3/4 |
| OL204R | SHARP/BLUNT | 5 3/4 |



MB571R-MB572R

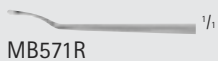

MB571R

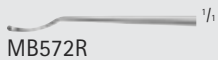

MB572R

HOUGH "Whirlybird" Excavator

| Catalog Number | Tip | Length (in.) |
|----------------|---------|--------------|
| MB571R | CVD-LFT | 6 |
| MB572R | CVD-RT | 6 |

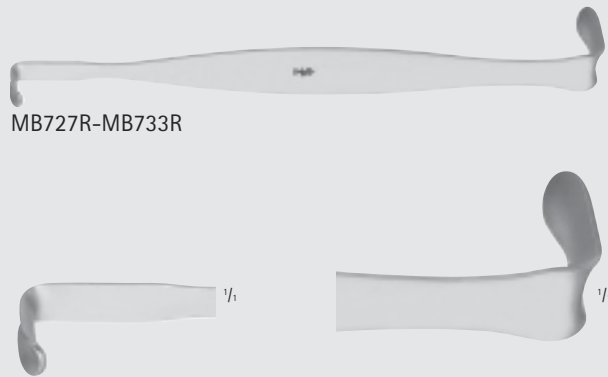

MB727R-MB733R

CRILE Retractor

| Catalog Number | Size | Blade Size (mm) | Length (in.) |
|----------------|------|-------------------|--------------|
| MB727R | 1 | 3 x 11 / 6 x 21 | 4 1/4 |
| MB728R | 2 | 6 x 13 / 10 x 21 | 6 1/8 |
| MB729R | 3 | 16 x 25 / 17 x 35 | 6 1/4 |
| MB730R | 4 | 22 x 29 / 29 x 44 | 7 |
| MB731R | 5 | 29 x 41 / 35 x 51 | 7 |
| MB732R | 6 | 32 x 64 / 35 x 70 | 8 |
| MB733R | 7 | 41 x 76 / 51 x 79 | 9 |



MB107R

CONVERSE Nasal Retractor

| Catalog Number | Blade Size (mm) | Length (in.) |
|----------------|-----------------|--------------|
| MB107R | 44 x 11 | 4 1/2 |

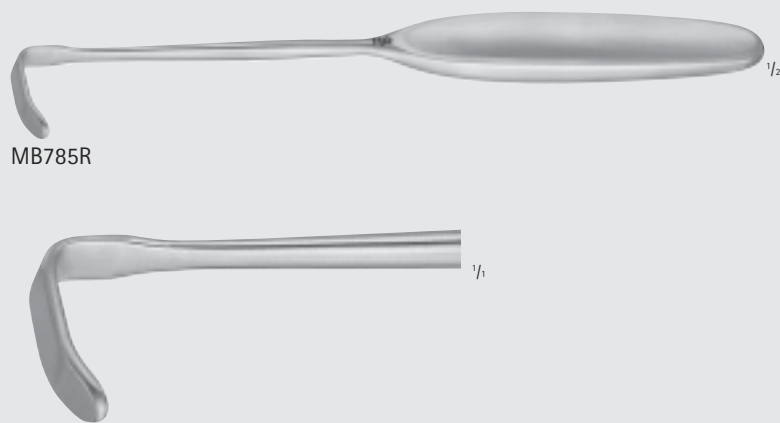

MB785R

LAHEY Goiter Retractor

| Catalog Number | Blade Size (mm) | Length (in.) |
|----------------|-----------------|--------------|
| MB785R | 24 x 8 | 8 |



INCHES

Ear/Nose/Throat

Retractors



OK800R

BRUENINGS-BRUNK Antrum Retractor

| Catalog Number | Length (in.) |
|----------------|--------------|
| OK800R | 7 1/2 |



OL211R



MASING Retractor

| Catalog Number | Blade Size (mm) | Length (in.) |
|----------------|-----------------|--------------|
| OL211R | 6 x 12 | 5 1/2 |

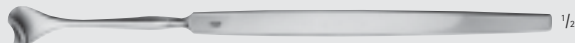

OL212R



COTTLE Retractor

| Catalog Number | Blade Size (mm) | Length (in.) |
|----------------|-----------------|--------------|
| OL212R | 10 x 12 | 5 1/2 |



BT004R

RAGNELL Retractor

| Catalog Number | Blade Size (mm) | Length (in.) |
|----------------|------------------|--------------|
| BT004R | 3 x 5 / 6.3 x 14 | 6 |

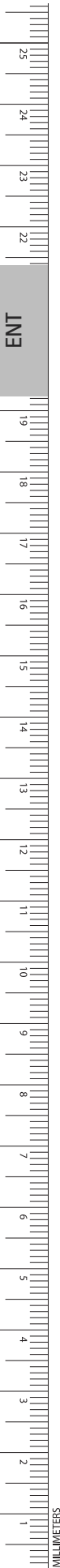



MD497

GOELET Retractor

| Catalog Number | Blade End | Length (in.) |
|----------------|-----------|--------------|
| MD497 | DBL-END | 7 1/2 |

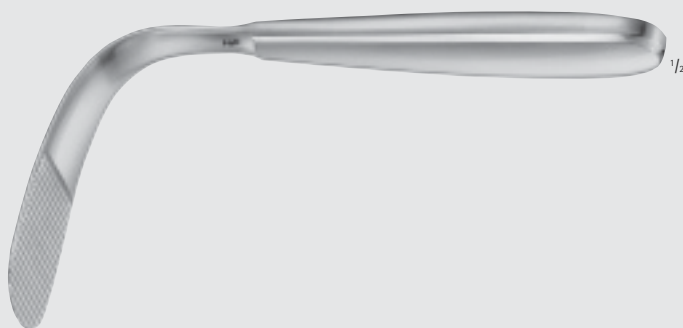

OM235R

TOBOLD Tongue Depressor

| Catalog Number | Length (in.) |
|----------------|--------------|
| OM235R | 6 1/4 |



OM236R-OM237R

WEDER Tongue Depressor

| Catalog Number | Size | Length (in.) |
|----------------|-------|--------------|
| OM236R | SMALL | 6 |
| OM237R | LARGE | 6 |

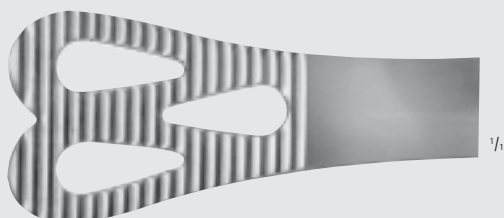

OM236R

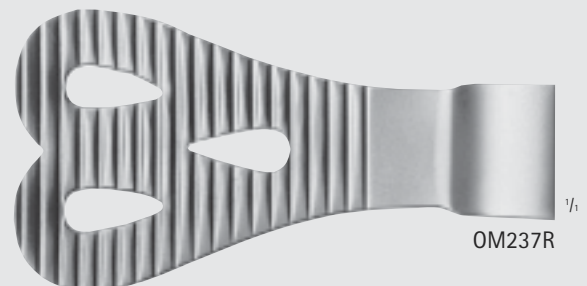

OM237R



INCHES

Ear/Nose/Throat

Retractors



MB054R



WULLSTEIN Retractor

| Catalog Number | Tip | Blade End | Length (in.) |
|----------------|-------|--------------|--------------|
| MB054R | BLUNT | 3 x 3 PRONGS | 4 1/4 |

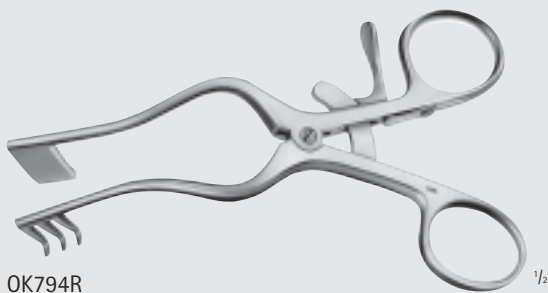

OK794R



PERKINS Antrum Retractor

| Catalog Number | Right Blade | Left Blade | Length (in.) |
|----------------|-------------|------------|--------------|
| OK794R | SOLID | 3 PRONGS | 5 1/8 |
| OK795R | 3 PRONGS | SOLID | 5 1/8 |

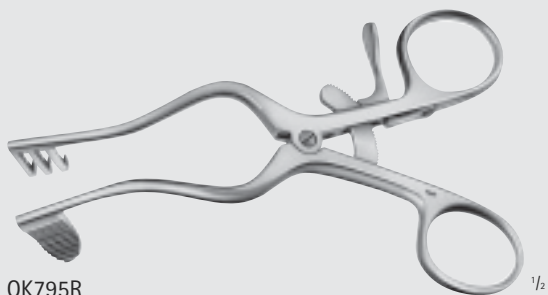

OK795R



ENT

MILLIMETERS

JANSEN Retractor

| Catalog Number | Tip | Blade End | Length (in.) |
|----------------|-------|--------------|--------------|
| BV030R | SHARP | 3 x 3 PRONGS | 4 |
| BV032R | BLUNT | 3 x 3 PRONGS | 4 |
| BV033R | BLUNT | 3 x 4 PRONGS | 4 |

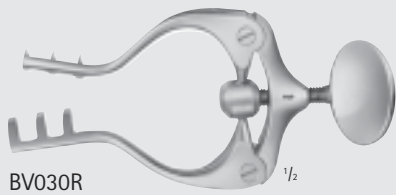

BV030R

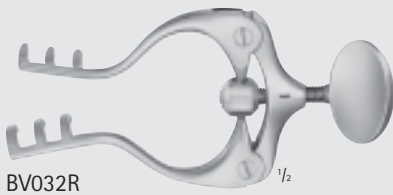

BV032R

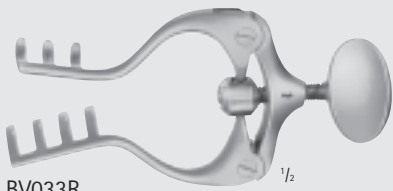

BV033R

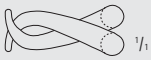

PLESTER Retractor

| Catalog Number | Tip | Blade End | Length (in.) |
|----------------|-------|--------------|--------------|
| BV078R | SHARP | 2 x 2 PRONGS | 5 1/8 |

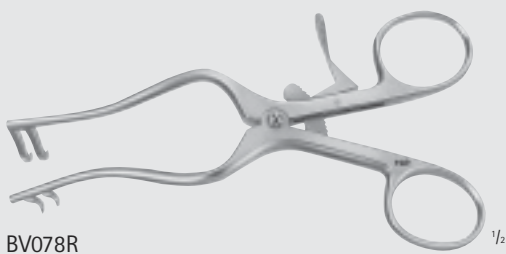

BV078R

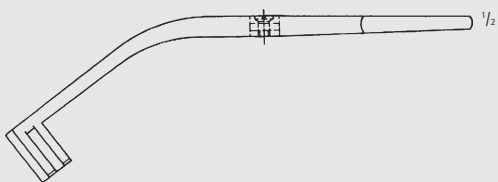

INCHES

Ear/Nose/Throat

Retractors



OK099R

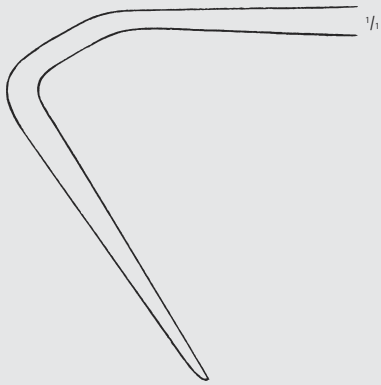

AUFRICHT Retractor Speculum

| Catalog Number | Length (in.) |
|----------------|--------------|
| OK099R | 6 1/4 |



Ear/Nose/Throat

Adenotomes, Dissectors & Snares



ENT

OL168R Olive Diam. 6 - 10 mm

$\frac{1}{2}$
 $\frac{1}{1}$

| Catalog Number | Length (in.) |
|----------------|--------------|
| OL168R | 7 |

OM660R $\frac{1}{2}$

6 mm $\frac{1}{1}$

OM661R $\frac{1}{2}$

10 mm $\frac{1}{1}$

| Catalog Number | Tip Size (mm) | Length (in.) |
|----------------|---------------|--------------|
| OM660R | 6 | 8 1/2 |
| OM661R | 10 | 8 1/2 |

OM668R $\frac{1}{2}$

12 mm $\frac{1}{1}$

| Catalog Number | Tip Size (mm) | Length (in.) |
|----------------|---------------|--------------|
| OM668R | 12 | 9 1/4 |

MB297R $\frac{1}{2}$

$\frac{1}{1}$
 $\frac{1}{1}$

| Catalog Number | Tip | Length (in.) |
|----------------|-------------|--------------|
| MB297R | SHARP/BLUNT | 7 1/2 |

INCHES

Ear/Nose/Throat

Adenotomes, Dissectors & Snares



MB332R-MB333R

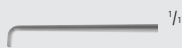

MB332R

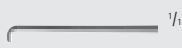

MB333R

CRABTREE "JIMMY" Dissector

| Catalog Number | Size | Tip Size (mm) | Length (in.) |
|----------------|-------|---------------|--------------|
| MB332R | LARGE | 2.0 | 6 1/2 |
| MB333R | SMALL | 1.3 | 6 1/2 |

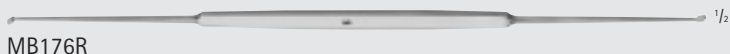

MB176R

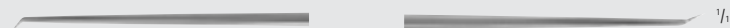

MC CABE Flap Knife Dissector

| Catalog Number | Blade End | Length (in.) |
|----------------|-----------|--------------|
| MB176R | 20° / 40° | 7 1/4 |

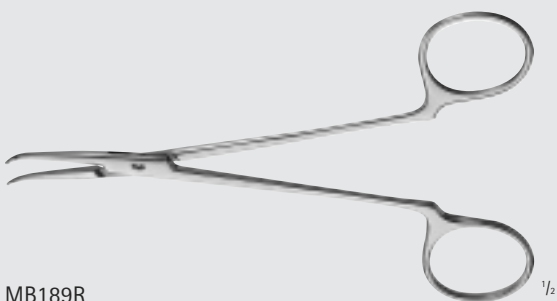

MB189R

MC CABE Facial Nerve Dissector

| Catalog Number | Jaw | Jaw Size (mm) | Length (in.) |
|----------------|-----|---------------|--------------|
| MB189R | ANG | 26 | 5 1/2 |



MB312R

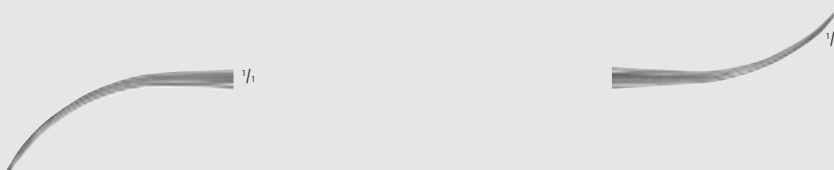

ROGERS Submucous Dissector

| Catalog Number | Length (in.) |
|----------------|--------------|
| MB312R | 8 3/4 |



MB313R

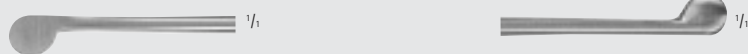

PIERCE Submucous Dissector

| Catalog Number | Length (in.) |
|----------------|--------------|
| MB313R | 7 1/2 |

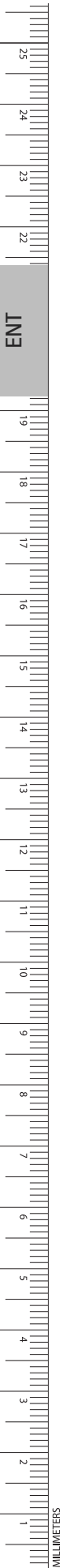

Ear/Nose/Throat

Adenotomes, Dissectors & Snares



LA FORCE Adenotome

| Catalog Number | Size | Item | Length (in.) |
|----------------|------|--------------------|--------------|
| OM391R | 1 | | 9 1/4 |
| OM392R | 2 | | 9 1/4 |
| OM393R | 3 | | 9 1/4 |
| OM396R | | SPARE BLD F/OM391R | |
| OM397R | | SPARE BLD F/OM392R | |
| OM398R | | SPARE BLD F/OM393R | |



OM391R-OM398R



OM396R



OM397R



OM398R

Ear Snare Wire

| Catalog Number | Diameter (mm) | Sales Unit |
|----------------|---------------|------------|
| OF528R | 0.2 | 100/BOX |



OF528R

KRAUSE Ear Snare, Extra Delicate

| Catalog Number | Length (in.) |
|----------------|--------------|
| OF505R | 6 1/4 |



OF505R

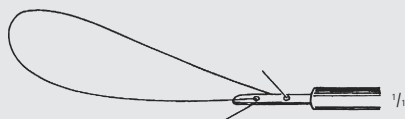

INCHES

Ear/Nose/Throat

Adenotomes, Dissectors & Snares

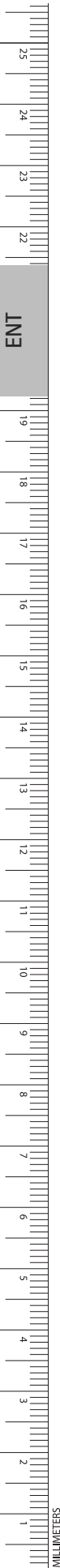

KRAUSE Nasal Polyp Snare, Knee-Shape

| Catalog Number | Length (in.) |
|----------------|--------------|
| OK260R | 10 |

OK260R

KRAUSE-VOSS Nasal Polyp Snare, Knee-Shape, Vert/Ho

| Catalog Number | Length (in.) |
|----------------|--------------|
| OK263R | 10 |

OK263R

WILDE Nasal Polyp Snare

| Catalog Number | Tip | Length (in.) |
|----------------|------|--------------|
| OK270R | BAYO | 10 |

OK270R

Nasal Snare Wire

| Catalog Number | Diameter (mm) | Sales Unit |
|----------------|---------------|------------|
| OK293R | 0.3 | 100/BOX |

OK293R

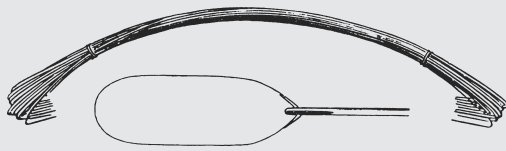

OM750R-OM751R

Tonsil Snare Wire

| Catalog Number | Diameter (mm) | Sales Unit |
|----------------|---------------|------------|
| OM750R | 0.3 | 12/BOX |
| OM751R | 0.5 | 12/BOX |

EVES Tonsil Snare

| Catalog Number | Length (in.) |
|----------------|--------------|
| OM760R | 10 |

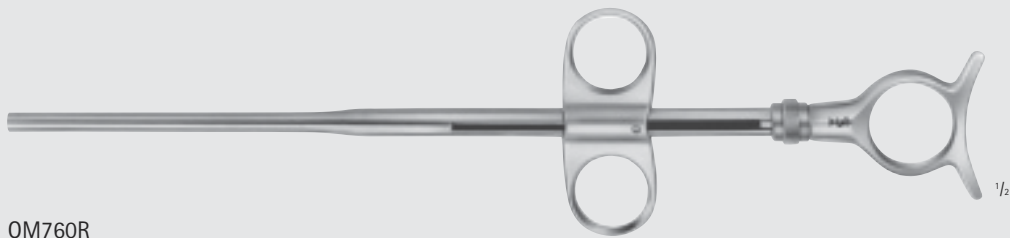

OM760R

EVES Tonsil Snare, Ratcheted

| Catalog Number | Length (in.) |
|----------------|--------------|
| OM761R | 10 |

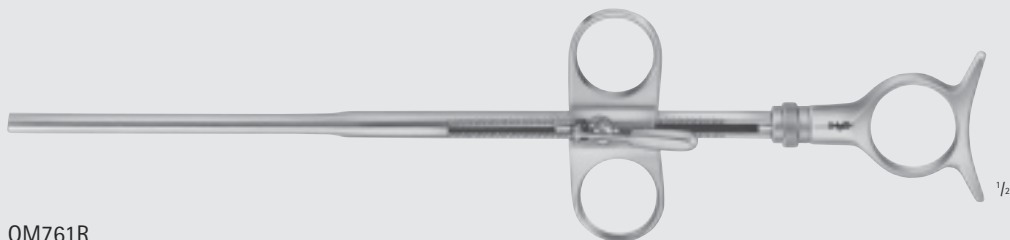

OM761R



INCHES

Ear/Nose/Throat

Adenotomes, Dissectors & Snares



OM776R

TYDING Straight Tip F/OM781R

| |
|----------------|
| Catalog Number |
| OM776R |

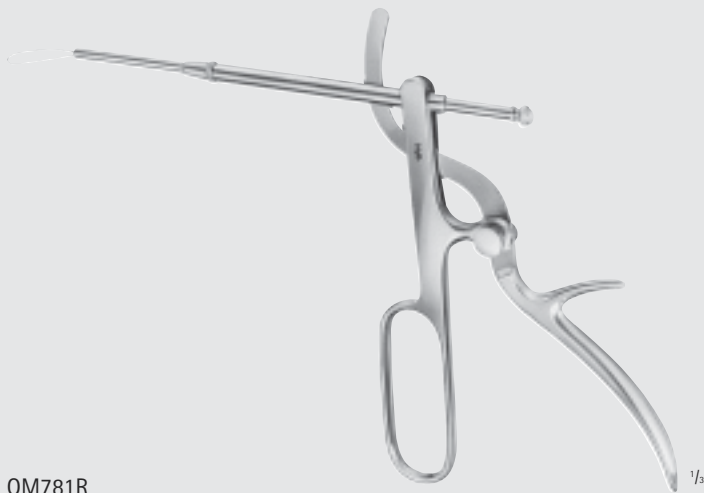

OM781R

TYDING Tonsil Snare, W/Detachable Tip

| |
|----------------|
| Catalog Number |
| OM781R |





OM038R

MOLT Mouth Gag

| Catalog Number | Size | Length (in.) |
|----------------|-----------|--------------|
| OM038R | PEDIATRIC | 4 |



OM040R

DOYEN-COLLIN Mouth Gag

| Catalog Number | Length (in.) |
|----------------|--------------|
| OM040R | 4 3/4 |



OM041R

DOYEN-JANSEN Mouth Gag

| Catalog Number | Length (in.) |
|----------------|--------------|
| OM041R | 5 1/2 |



OM047R

Mouth Gag

| Catalog Number | Length (in.) |
|----------------|--------------|
| OM047R | 5 |

Ear/Nose/Throat

Mouth Gags



OP299

Teeth Protector

| |
|----------------|
| Catalog Number |
| OP299 |



OM070R-OM073R

WHITEHEAD-JENNINGS Mouth Gag

| Catalog Number | Length (in.) |
|----------------|--------------|
| OM070R | 3 1/2 |
| OM071R | 4 1/2 |
| OM072R | 5 |
| OM073R | 6 |

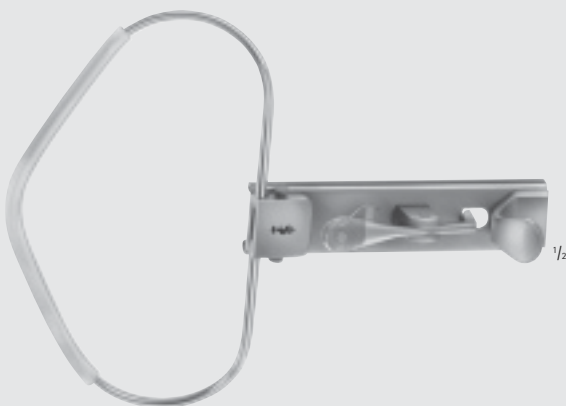

OM104R

MC IVOR Frame, F/Tongue Depressor

| |
|----------------|
| Catalog Number |
| OM104R |

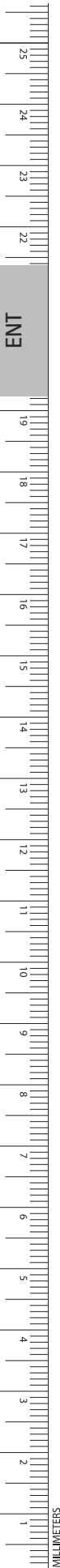

MC IVOR Blades, F/Tongue Depressor

| Catalog Number | Tip Size (mm) |
|----------------|---------------|
| OM101R | 25 x 55 |
| OM102R | 25 x 62 |
| OM103R | 25 x 75 |



OM101R-OM103R



OM101R



OM102R



OM103R

DAVIS-BOYLE Tongue Depressor Frame, F/Adult

| Catalog Number |
|----------------|
| OM116R |



OM116R

DAVIS-BOYLE Tongue Depressor Frame

| Catalog Number | Size |
|----------------|-------|
| OM118R | CHILD |
| OM119R | TEEN |



OM118R-OM119R



Ear/Nose/Throat

Mouth Gags



OM112R-OM115R

DAVIS-BOYLE Blade, F/Tongue Depressor Frame

| Catalog Number | Tip Size (mm) |
|----------------|---------------|
| OM112R | 25 x 62 |
| OM113R | 25 x 75 |
| OM114R | 25 x 92 |
| OM115R | 25 x 108 |



OM112R



OM113R

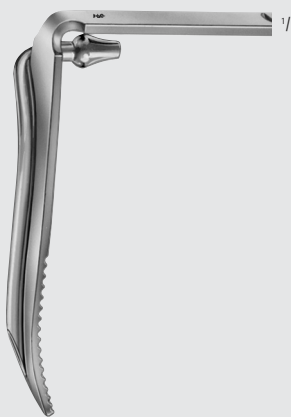

OM114R



OM115R

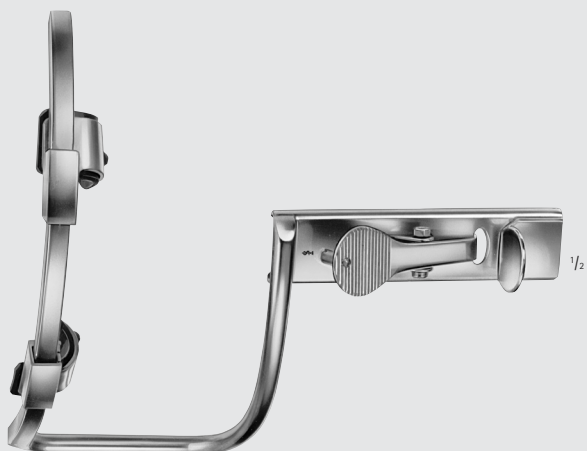

OM169R-OM179R

DAVIS-MEYER Tongue Depressor Frame

| Catalog Number | Item |
|----------------|------------------|
| OM169R | FRAME, COMPLETE |
| OM170 | SILICONE INSERTS |
| OM179R | PALATE BLADE |



OM170



OM179R

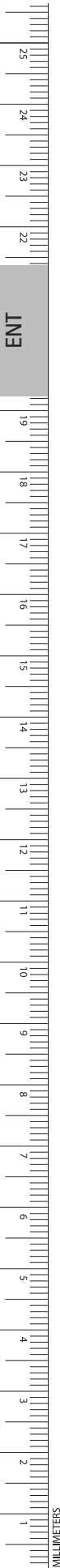

RUSSEL-DAVIS Tongue Blade

| Catalog Number | Tip Size (mm) |
|----------------|---------------|
| OM171R | 29 x 67 |
| OM172R | 33 x 75 |
| OM173R | 38 x 85 |
| OM174R | 40 x 92 |
| OM175R | 46 x 100 |
| OM176R | 18 x 57 |
| OM177R | 22 x 67 |
| OM178R | 25 x 75 |

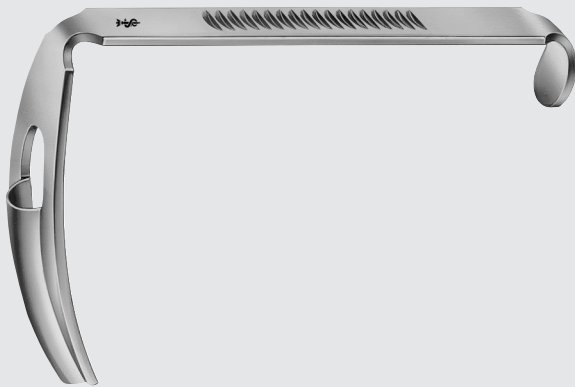

OM171R-OM175R



OM171R



OM172R



OM173R

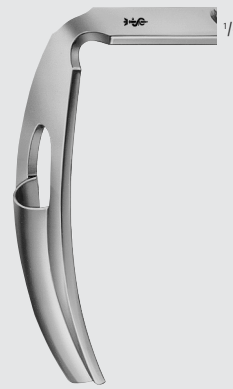

OM174R



OM175R



OM176R-OM178R



OM176R



OM177R



OM178R



INCHES

Ear/Nose/Throat

Mouth Gags



OM181R-OM183R

GAST Tongue Blade

| Catalog Number | Tip Size (mm) |
|----------------|---------------|
| OM181R | 28 x 64 |
| OM182R | 34 x 74 |
| OM183R | 38 x 87 |



OM181R



OM182R



OM183R

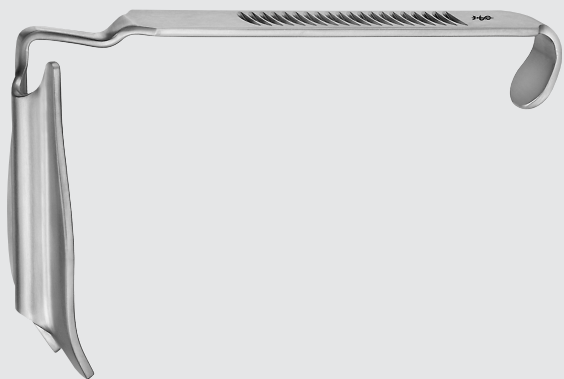

MB595R-MB600R

MC IVOR Ring Retractor Blades

| Catalog Number | Tip Size (mm) | Tip |
|----------------|---------------|-------|
| MB595R | 57 x 23 | RIGHT |
| MB596R | 72 x 27 | RIGHT |
| MB597R | 88 x 33 | RIGHT |
| MB598R | 57 x 23 | LEFT |
| MB599R | 72 x 27 | LEFT |
| MB600R | 88 x 33 | LEFT |



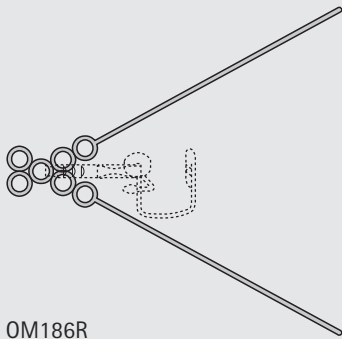

DRAFFIN Chest Support, W/4 Height Rings

| |
|----------------|
| Catalog Number |
| OM186R |

OM186R

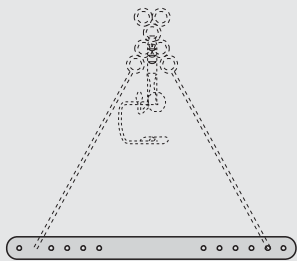

MAGAURAN Plate, F/Holding OM186R

| |
|----------------|
| Catalog Number |
| OM187R |

OM187R



INCHES

Ear/Nose/Throat

Specula

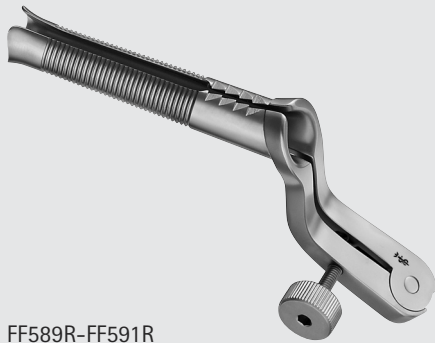

FF589R-FF591R



TE749R

PAPAVERO-CASPAR Transssphenoidal Speculum W/Key TE749R

| Catalog Number | Blade Size (mm) |
|----------------|-----------------|
| FF589R | 80 x 11 |
| FF590R | 90 x 13 |
| FF591R | 100 x 15 |
| TE749R | |



FF595R



PAPAVERO-HARTMANN Spreader, F/FF589R-FF591R

| Catalog Number |
|----------------|
| FF595R |



OK100R-OK102R

CUSHING-LANDOLT Transssphenoidal Speculum

| Catalog Number | Blade Size (mm) |
|----------------|-----------------|
| OK100R | 70 x 15 |
| OK101R | 90 x 15 |
| OK102R | 110 x 15 |

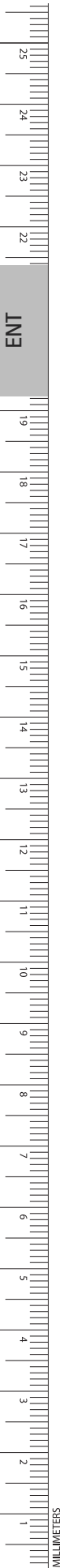



OK103R

**LANDOLT Spreader, F/Speculum
OK100R - OK102R**

| Catalog Number | Length (in.) |
|----------------|--------------|
| OK103R | 8 1/4 |



OK041R-OK043R

**HARTMANN Nasal Speculum,
Screw Joint**

| Catalog Number | Blade Size | Length (in.) |
|----------------|------------|--------------|
| OK041R | SMALL | 6 1/4 |
| OK042R | MEDIUM | 6 1/4 |
| OK043R | LARGE | 6 1/4 |



OK041R



OK042R



OK043R



OK047R-OK049R

**HARTMANN-HALLE Nasal Speculum,
Screw Joint**

| Catalog Number | Blade Size | Length (in.) |
|----------------|------------|--------------|
| OK047R | SMALL | 6 |
| OK048R | MEDIUM | 6 |
| OK049R | LARGE | 6 |



OK047R

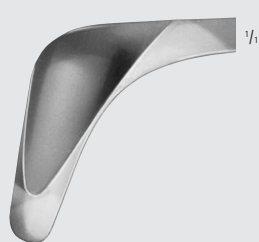

OK048R

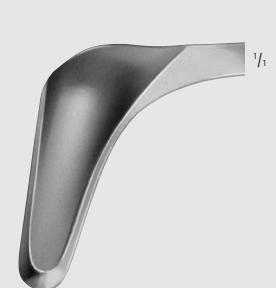

OK049R



Ear/Nose/Throat

Specula

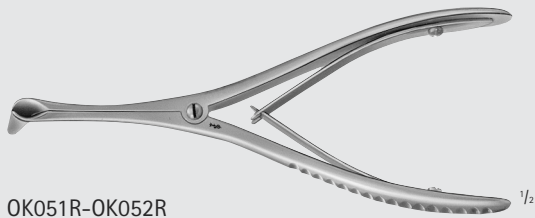

OK051R-OK052R

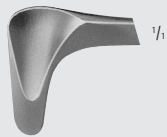

OK051R



OK052R

TIECK-HALLE Pediatric Nasal Speculum, Screw Joint

| Catalog Number | Blade Size | Length (in.) |
|----------------|------------|--------------|
| OK051R | SMALL | 5 1/4 |
| OK052R | LARGE | 5 1/4 |



OK053R



BECKMANN Pediatric Nasal Speculum, Screw Joint

| Catalog Number | Blade Size | Blade Shape | Length (in.) |
|----------------|------------|-------------|--------------|
| OK053R | SMALL | LAT-CVD | 5 1/2 |



OK058R



BECKMANN Nasal Speculum, Screw Joint

| Catalog Number | Blade Size | Blade Shape | Length (in.) |
|----------------|------------|-------------|--------------|
| OK058R | MEDIUM | LAT-CVD | 6 |

ENT

MILLIMETERS

VIENNA Nasal Speculum

| Catalog Number | Blade Size | Length (in.) |
|----------------|------------|--------------|
| OK060R | SMALL | 5 1/2 |
| OK061R | MEDIUM | 5 1/2 |
| OK062R | LARGE | 5 1/2 |

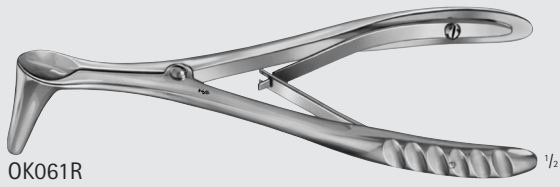

INCHES

Ear/Nose/Throat

Specula

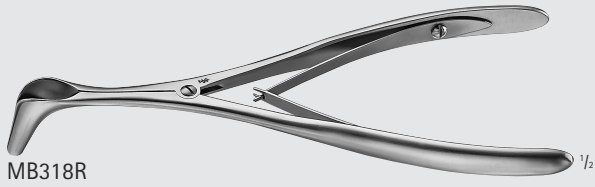

MB318R

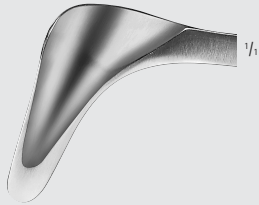

1/4

SONNENSCHNEIN Nasal Speculum

| Catalog Number | Blade Size | Length (in.) |
|----------------|------------|--------------|
| MB318R | MEDIUM | 6 |



OK081R-OK084R



1/4



1/4

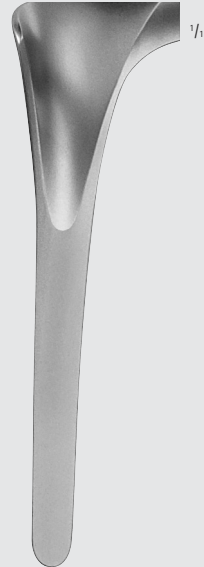

1/4



1/4

OK081R

OK082R

OK083R

OK084R

KILLIAN Septum Speculum, Aseptic Joint

| Catalog Number | Blade Size (mm) | Length (in.) |
|----------------|-----------------|--------------|
| OK081R | 36 x 7 | 5 3/4 |
| OK082R | 56 x 7 | 5 3/4 |
| OK083R | 75 x 7 | 5 3/4 |
| OK084R | 90 x 7 | 5 3/4 |



HARTMANN Nasal Speculum, Light

| Catalog Number | Length (in.) |
|----------------|--------------|
| OK030R | 5 3/4 |



OK091R-OK094R

KILLIAN Septum Speculum, Screw Joint

| Catalog Number | Blade Size (mm) | Length (in.) |
|----------------|-----------------|--------------|
| OK091R | 36 x 7 | 5 1/2 |
| OK092R | 56 x 7 | 5 1/2 |
| OK093R | 75 x 7 | 5 1/2 |
| OK094R | 90 x 7 | 5 1/2 |



OK091R



OK092R



OK093R



OK094R



Ear/Nose/Throat

Specula



OK085R

COTTLE Septum Speculum

| Catalog Number | Blade Size (mm) | Blade Shape | Length (in.) |
|----------------|-----------------|-------------|--------------|
| OK085R | 50 x 6 | TAPERED | 5 1/4 |
| OK089R | 76 x 7 | THIN | 5 1/4 |
| OK090R | 90 x 7 | THIN | 5 1/4 |



OK089R-OK090R



OK089R



OK090R



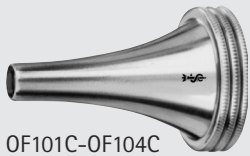



OF101C-OF104C

POLITZER Pediatric Ear Speculum, Round

| Catalog Number | Tip Size (mm) |
|----------------|-------------------------|
| OF101C | COMPLETE SET OF 3 SIZES |
| OF102C | 2 |
| OF103C | 3 |
| OF104C | 4 |

 OF102C

 OF103C

 OF104C



OF111C-OF114C

HARTMANN Ear Speculum, Round

| Catalog Number | Tip Size (mm) |
|----------------|---------------|
| OF111C | 3.5 |
| OF112C | 5 |
| OF113C | 6.5 |
| OF114C | 8 |

 OF111C

 OF112C

 OF113C

 OF114C

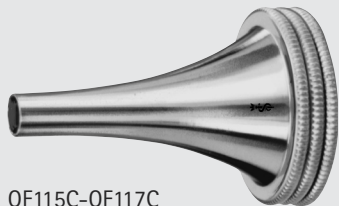



OF115C-OF117C

HARTMANN Pediatric Ear Speculum, Round

| Catalog Number | Tip Size (mm) |
|----------------|---------------|
| OF115C | 1.8 |
| OF116C | 3.2 |
| OF117C | 4.6 |

 OF115C

 OF116C

 OF117C



OF120C-OF124C

BOUCHERON Ear Speculum, Round

| Catalog Number | Tip Size (mm) |
|----------------|-------------------------|
| OF120C | COMPLETE SET OF 4 SIZES |
| OF121C | 4.2 |
| OF122C | 5.2 |
| OF123C | 6.2 |
| OF124C | 7.2 |

 OF121C

 OF122C

 OF123C

 OF124C



INCHES

Ear/Nose/Throat

Specula



MB242R-MB244R

GRUBER Ear Speculum, Oval

| Catalog Number | Tip Size (mm) |
|----------------|---------------|
| MB242R | 2.0 x 2.5 |
| MB243R | 2.5 x 3.0 |
| MB244R | 3.0 x 4.0 |



OF136-OF139

HARTMANN Black Ear Speculum, Round

| Catalog Number | Tip Size (mm) |
|----------------|---------------|
| OF136 | 3 |
| OF137 | 4 |
| OF138 | 5 |
| OF139 | 7 |
| OF158 | 8 |
| OF159 | 9 |

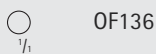

OF136

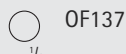

OF137

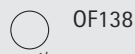

OF138



OF139



OF158-OF159



OF158



OF159



OF171-OF176

ZOELLNER Black Ear Speculum, Oval

| Catalog Number | Tip Size (mm) |
|----------------|---------------|
| OF171 | 5.5 x 6.5 |
| OF172 | 6.5 x 7.5 |
| OF173 | 7.5 x 8.5 |
| OF174 | 8.5 x 9.5 |
| OF175 | 9.5 x 10.5 |
| OF176 | 10.5 x 11.5 |

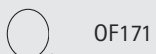

OF171

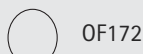

OF172

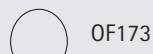

OF173



OF174



OF175



OF176

ENT

MILLIMETERS

Ear/Nose/Throat Cotton Carriers



LATHBURY-FARRELL Cotton Applicator

| Catalog Number | Tip Size (mm) | Tip | Length (in.) |
|----------------|---------------|----------|--------------|
| BN465R | 1.4 | TRI-SERR | 5 1/2 |
| BN466R | 1.2 | TRI-SERR | 6 1/4 |
| BN467R | 0.9 | TRI-SERR | 5 1/2 |
| BN468R | 1.4 | TRI-SERR | 6 1/4 |

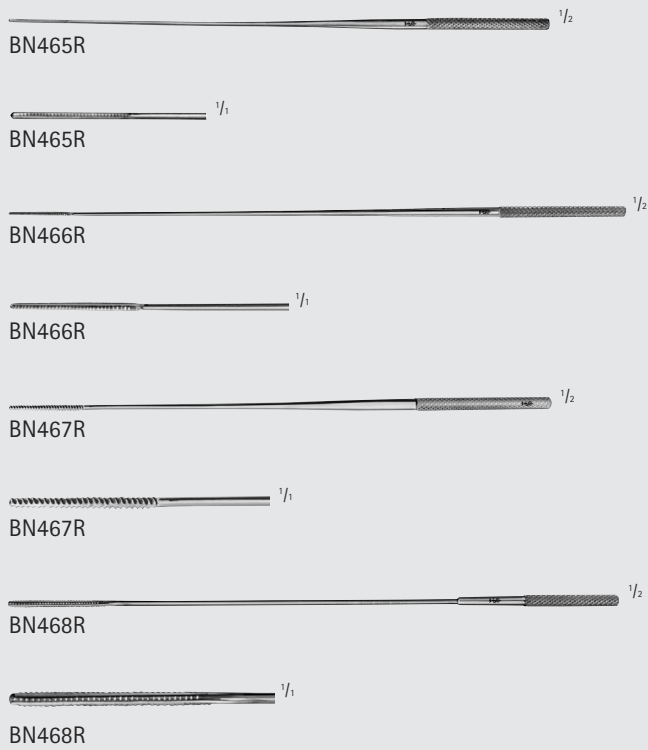

Cotton Applicator

| Catalog Number | Tip Size (mm) | Tip | Length (in.) |
|----------------|---------------|--------|--------------|
| BN452R | 1.5 | SPIRAL | 7 |
| BN457R | 1.8 | SPIRAL | 7 |

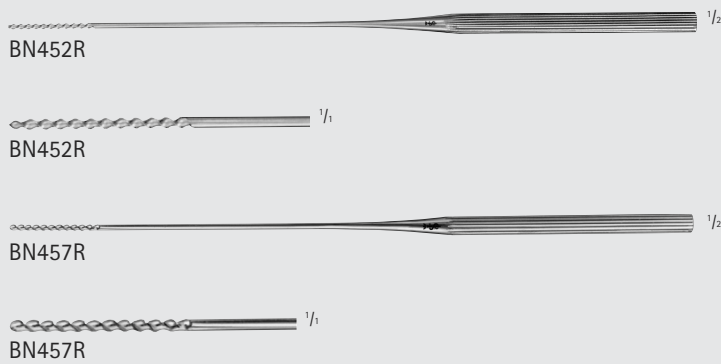

FARRELL Cotton Applicator

| Catalog Number | Tip Size (mm) | Tip | Length (in.) |
|----------------|---------------|----------|--------------|
| BN460R | 1.2 | RND-SERR | 5 1/2 |
| BN461R | 1.2 | SPIRAL | 6 1/4 |

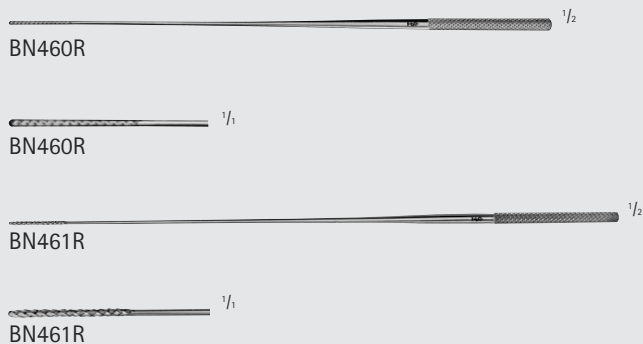

Ear/Nose/Throat

Cotton Carriers



KILLIAN Laryngeal Applicator

| Catalog Number | Length (in.) |
|----------------|--------------|
| BN490R | 10 |



MB044R

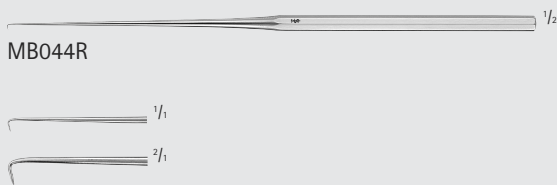

GUILFORD-WRIGHT Stapes Pick

| Catalog Number | Tip | Length (in.) |
|----------------|-----|--------------|
| MB044R | 90° | 5 1/2 |

MB055R

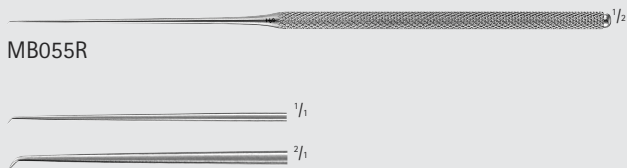

AUSTIN Pick

| Catalog Number | Tip | Tip Size (mm) | Length (in.) |
|----------------|-----|---------------|--------------|
| MB055R | 45° | 1.0 | 6 1/4 |

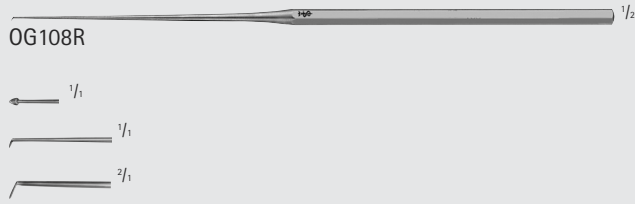

ROSEN Knife/Elevator

| Catalog Number | Tip | Length (in.) |
|----------------|----------|--------------|
| OG108R | SPEAR-PT | 6 1/4 |

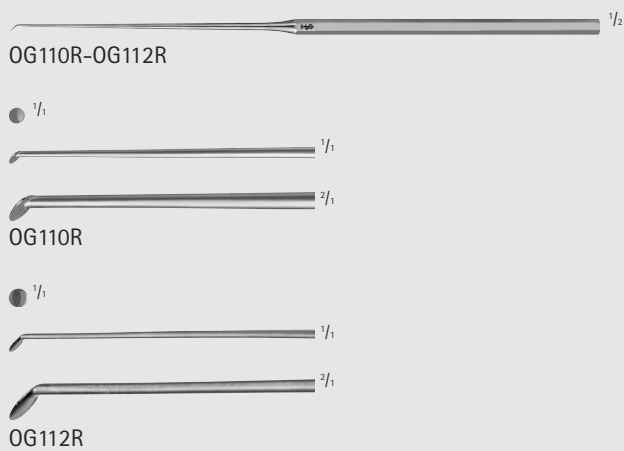

Round Cutting Knife

| Catalog Number | Tip Size (mm) | Angle | Length (in.) |
|----------------|---------------|-------|--------------|
| OG110R | 2.0 | 45° | 6 1/4 |
| OG112R | 2.6 | 45° | 6 1/4 |

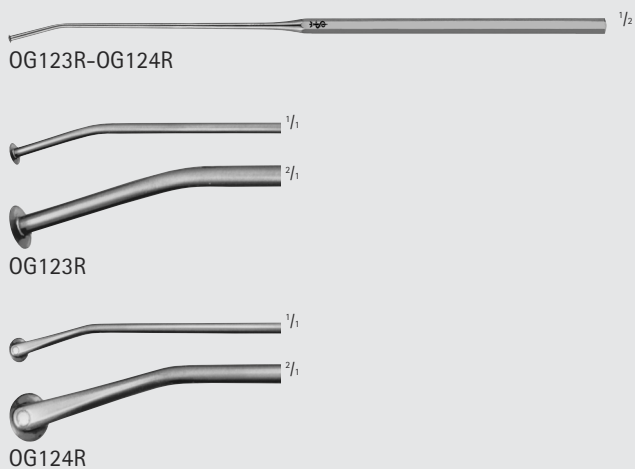

SCHUKNECHT Roller Knife

| Catalog Number | Blade Shape | Length (in.) |
|----------------|-------------|--------------|
| OG123R | RT-ANG | 6 1/4 |
| OG124R | STR | 6 1/4 |



INCHES

Ear/Nose/Throat

Knives

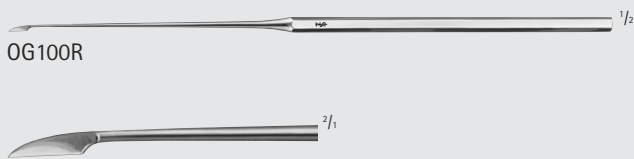

OG100R

Footplate Knife

| Catalog Number | Blade Shape | Length (in.) |
|----------------|-------------|--------------|
| OG100R | STR | 6 1/4 |

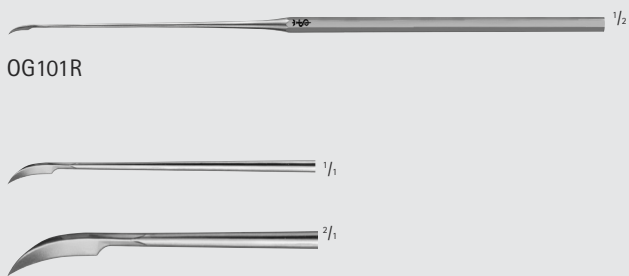

OG101R

PLESTER Sickle Knife

| Catalog Number | Blade Shape | Length (in.) |
|----------------|-------------|--------------|
| OG101R | CVD | 6 1/4 |

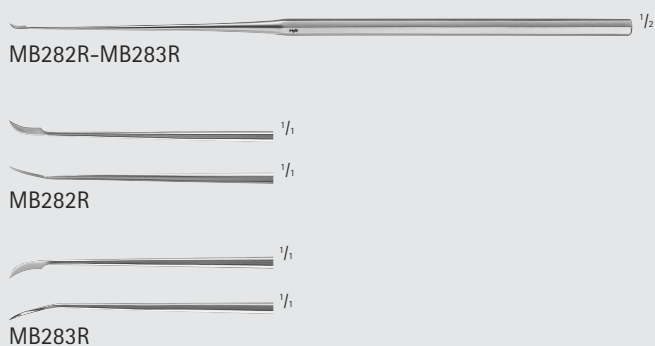

MB282R-MB283R

PAPARELLA Sickle Knife, #14

| Catalog Number | Tip | Length (in.) |
|----------------|---------|--------------|
| MB282R | CVD-RT | 6 1/2 |
| MB283R | CVD-LFT | 6 1/2 |

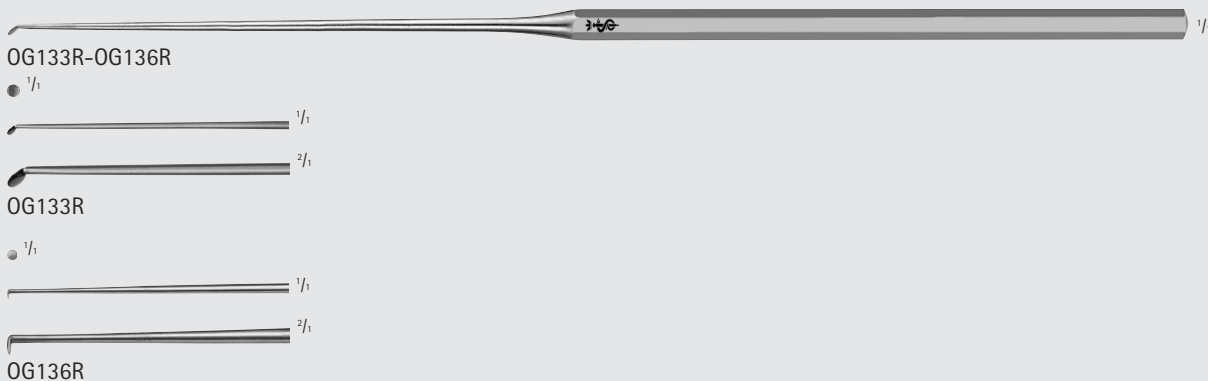

OG133R-OG136R

Round Cutting Knife

| Catalog Number | Tip Size (mm) | Angle | Length (in.) |
|----------------|---------------|-------|--------------|
| OG133R | 1.5 | 45° | 6 1/4 |
| OG136R | 1.5 | 90° | 6 1/4 |

OG133R

OG136R

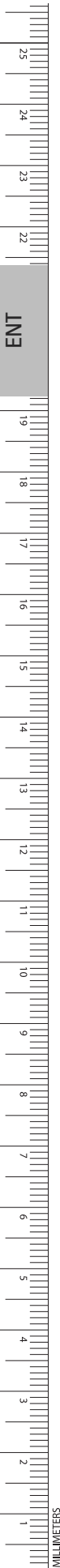



OL102R-OL104R

JOSEPH Nasal Knife, Double Edge

| Catalog Number | Tip | Length (in.) |
|----------------|-----|--------------|
| OL102R | STR | 5 3/4 |
| OL104R | CVD | 5 3/4 |



OL102R



OL104R



OL107R

JOSEPH Button End Knife

| Catalog Number | Tip | Length (in.) |
|----------------|-----|--------------|
| OL107R | CVD | 7 |
| OL111R | STR | 5 1/2 |



OL111R



OL109R

CONVERSE Button End Knife

| Catalog Number | Tip | Length (in.) |
|----------------|-----|--------------|
| OL109R | CVD | 6 |



OL113R

COTTLE Septum Knife

| Catalog Number | Tip | Length (in.) |
|----------------|-----|--------------|
| OL113R | STR | 5 1/2 |



Ear/Nose/Throat

Knives



OL120R



FREER Mucous Knife

| Catalog Number | Length (in.) |
|----------------|--------------|
| OL120R | 6 |



MB118R-MB119R

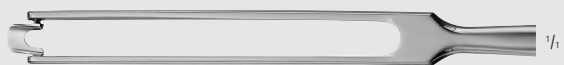

MB118R



MB119R

BALLENGER Swivel Knife

| Catalog Number | Tip Size (mm) | Length (in.) |
|----------------|---------------|--------------|
| MB118R | 4 | 7 3/4 |
| MB119R | 3 | 7 3/4 |



OL354R-OL356R



OL354R



OL355R



OL356R

BALLENGER Swivel Knife

| Catalog Number | Tip Size (mm) | Handle | Length (in.) |
|----------------|---------------|--------|--------------|
| OL354R | 4 x 3 | BAYO | 8 1/4 |
| OL355R | 5 x 4 | BAYO | 8 1/4 |
| OL356R | 6 x 5 | BAYO | 8 1/4 |



OM681R



ABRAHAM Tonsil Knife

| Catalog Number | Length (in.) |
|----------------|--------------|
| OM681R | 8 1/2 |



OM688R



FISHER Tonsil Knife

| Catalog Number | Length (in.) |
|----------------|--------------|
| OM688R | 8 |

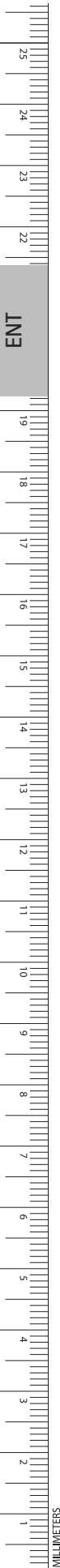

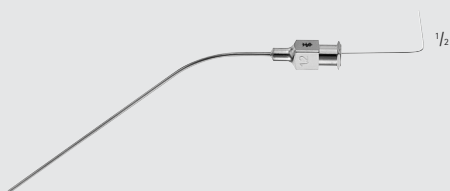

MB450R-MB453R

ROSEN Suction Tube

| Catalog Number | Tip | Length (in.) |
|----------------|-------|--------------|
| MB450R | 18 GA | 3 1/2 |
| MB451R | 20 GA | 3 1/2 |
| MB452R | 22 GA | 3 1/2 |
| MB453R | 24 GA | 3 1/2 |

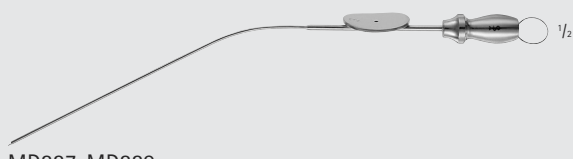

MD887-MD889

BARON Suction Tube W/Stylet

| Catalog Number | Tip | Length (in.) |
|----------------|------|--------------|
| MD887 | 3 FR | 5 1/2 |
| MD888 | 5 FR | 5 1/2 |
| MD889 | 7 FR | 5 1/2 |

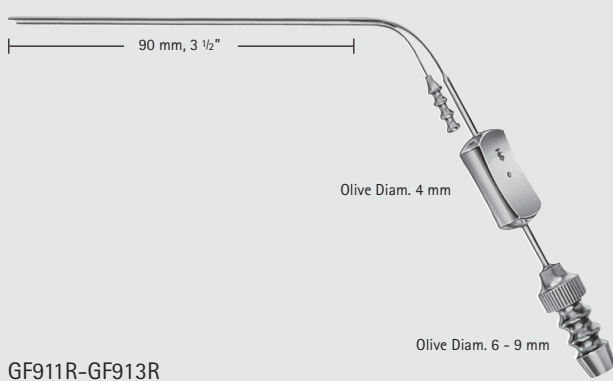

GF911R-GF913R

HOUSE Suction/Irrigation Cannula

| Catalog Number | Tip Size (mm) |
|----------------|---------------|
| GF911R | 0.9 / 0.7 |
| GF912R | 1.2 / 0.9 |
| GF913R | 1.5 / 1.2 |



MB614R-MB616R

HOUSE Suction Tube

| Catalog Number | Tip | Length (in.) |
|----------------|-------|--------------|
| MB614R | 18 GA | 4 1/8 |
| MB615R | 20 GA | 4 1/8 |
| MB616R | 22 GA | 4 1/8 |



GF919R

Nasal Suction Tube, Luer-Hub

| Catalog Number | Tip Size (mm) | Length (in.) |
|----------------|---------------|--------------|
| GF919R | DIAM. 5 | 7 |

Ear/Nose/Throat

Suction/Irrigation



FRAZIER Suction Cannula, Luer-Hub

| Catalog Number | Tip | Length (in.) |
|----------------|-------|--------------|
| GF923R | 9 FR | 7 |
| GF925R | 15 FR | 7 |



HOUSE Suction Adapter, W/Finger Cut-Off

| Catalog Number | Length (in.) |
|----------------|--------------|
| GF768R | 2 1/8 |

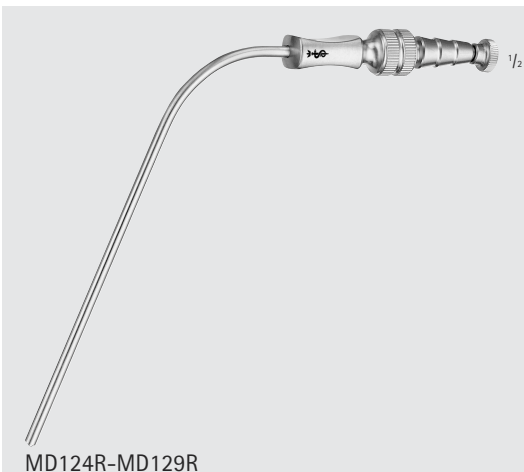

FRAZIER Suction Cannula

| Catalog Number | Tip | Length (in.) |
|----------------|-------|--------------|
| MD124R | 7 FR | 4 1/4 |
| MD125R | 8 FR | 4 1/4 |
| MD127R | 10 FR | 4 1/4 |
| MD129R | 12 FR | 4 1/4 |

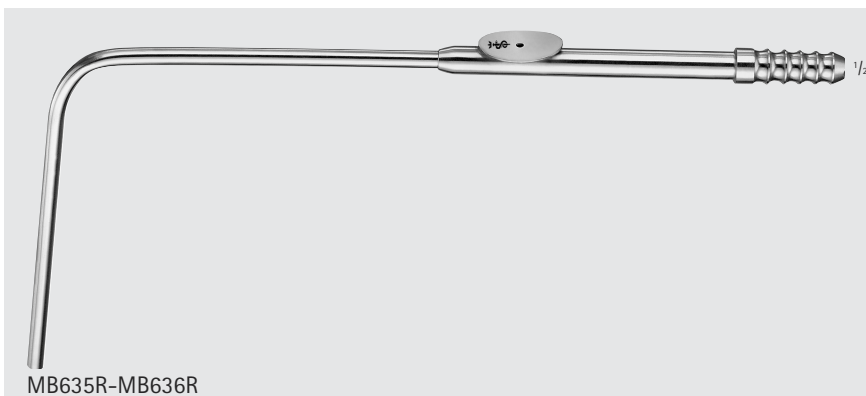

SACHS Suction Cannula

| Catalog Number | Tip | Length (in.) |
|----------------|-------|--------------|
| MB635R | SMALL | 8 1/2 |
| MB636R | LARGE | 8 1/2 |

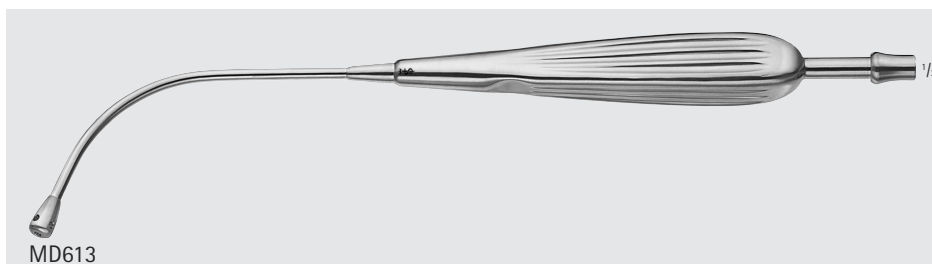

ANDREWS Pynchon Suction Tube

| Catalog Number | Length (in.) |
|----------------|--------------|
| MD613 | 9 |

Ear/Nose/Throat Suction/Irrigation

YANKAUER Suction Cannula

| Catalog Number | Tip Opening (mm) | Length (in.) |
|----------------|------------------|--------------|
| GF944R | 2.0 | 11 1/4 |

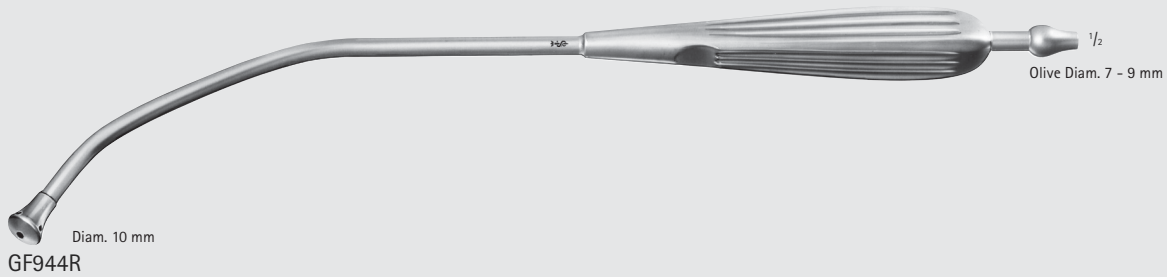

BARON Suction Tube

| Catalog Number | Tip | Length (in.) |
|----------------|-----|--------------|
| MB380R | 3FR | 4 |
| MB381R | 3FR | 4 |
| MB382R | 7FR | 4 |

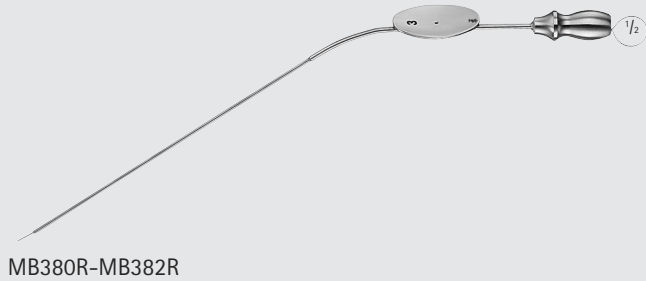

Suction Tube, W/Finger Cut-Off

| Catalog Number | Tip Size (mm) | Length (in.) |
|----------------|---------------|--------------|
| OP360R | 2 | 10 |
| OP361R | 2.5 | 10 |
| OP362R | 3 | 10 |

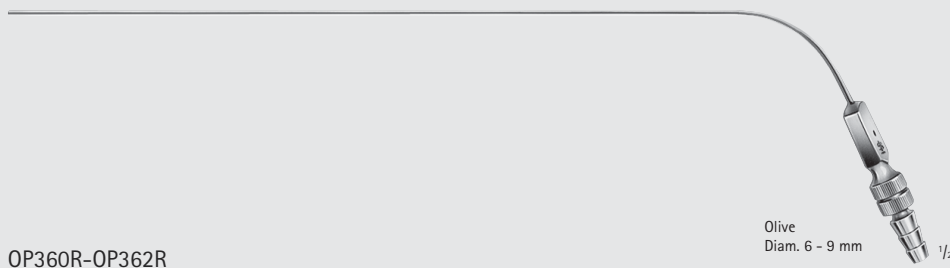

Ear/Nose/Throat

Suction/Irrigation



ENT

JACKSON Velvet Eye Aspirating Tube

| Catalog Number | Diameter (mm) | Length (in.) |
|----------------|---------------|--------------|
| MB366R | 4.0 | 10 |
| MB367R | 4.0 | 16 3/8 |
| MB368R | 4.0 | 22 |
| MB369R | 4.0 | 18 1/8 |

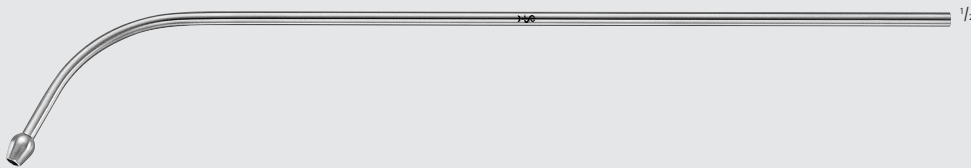

MB366R-MB369R

EICKEN Cannula

| Catalog Number | Tip | Diameter (mm) | Length (in.) |
|----------------|-------|---------------|--------------|
| OK874C | BLUNT | 2.5 | 5 1/8 |
| OK875C | BLUNT | 3.0 | 5 1/8 |

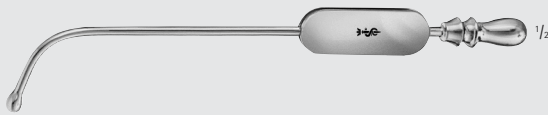

OK874C-OK875C

HAJEK Irrigating Cannula

| Catalog Number | Diameter (mm) | Length (in.) |
|----------------|---------------|--------------|
| OK900 | 3,5 | 6 1/2 |



OK900

Luer Lock Adapter

| Catalog Number | Length (in.) |
|----------------|--------------|
| MB634R | 1 1/2 |



MB634R

Ear/Nose/Throat Bone Instruments



PAPAVERO Bayonet Chisel

| Catalog Number | Tip Size (mm) | Length (in.) |
|----------------|---------------|--------------|
| FF610R | 4 | 8 3/4 |



FREER Chisel

| Catalog Number | Tip Size (mm) | Blade Shape | Length (in.) |
|----------------|---------------|-------------|--------------|
| OL311R | 4 | STR | 6 1/4 |
| OL314R | 4 | CVD | 6 1/4 |

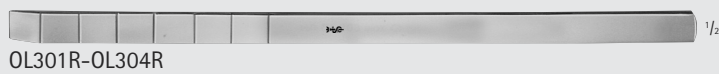
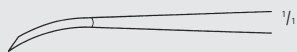
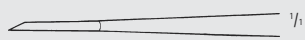

COTTLE Chisel, W/Depth Marks

| Catalog Number | Tip Size (mm) | Length (in.) |
|----------------|---------------|--------------|
| OL301R | 4 | 7 |
| OL302R | 7 | 7 |
| OL303R | 9 | 7 |
| OL304R | 12 | 7 |

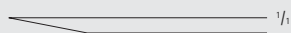

COTTLE Osteotome, W/Depth Marks

| Catalog Number | Tip Size (mm) | Length (in.) |
|----------------|---------------|--------------|
| OL294R | 4 | 7 |
| OL296R | 6 | 7 |
| OL298R | 8 | 7 |
| OL299R | 10 | 7 |
| OL300R | 12 | 7 |

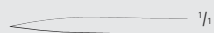

COTTLE Curved Osteotome

| Catalog Number | Tip Size (mm) | Length (in.) |
|----------------|---------------|--------------|
| OL305R | 6 | 7 |



INCHES

Ear/Nose/Throat

Bone Instruments



MB388R-MB389R

RUBIN Osteotome

| Catalog Number | Tip Size (mm) | Length (in.) |
|----------------|---------------|--------------|
| MB388R | 10 | 6 1/2 |
| MB389R | 14 | 6 1/2 |



MB398R-MB403R



CONVERSE Osteotome

| Catalog Number | Tip Size (mm) | Length (in.) |
|----------------|---------------|--------------|
| MB398R | 2 | 7 |
| MB399R | 4 | 7 |
| MB400R | 6 | 7 |
| MB401R | 8 | 7 |
| MB402R | 10 | 7 |
| MB403R | 12 | 7 |



MB590R-MB594R



CHERRY Osteotome

| Catalog Number | Tip Size (mm) | Length (in.) |
|----------------|---------------|--------------|
| MB590R | 3 | 8 |
| MB591R | 4 | 8 |
| MB592R | 5 | 8 |
| MB593R | 6 | 8 |
| MB594R | 7 | 8 |



MB373R-MB413R



Osteotome, Hexagonal Handle

| Catalog Number | Tip Size (mm) | Length (in.) |
|----------------|---------------|--------------|
| MB373R | 12 | 6 1/4 |
| MB404R | 2 | 6 1/4 |
| MB405R | 3 | 6 1/4 |
| MB406R | 4 | 6 1/4 |
| MB407R | 5 | 6 1/4 |
| MB408R | 6 | 6 1/4 |
| MB409R | 7 | 6 1/4 |
| MB410R | 8 | 6 1/4 |
| MB411R | 9 | 6 1/4 |
| MB412R | 10 | 6 1/4 |
| MB413R | 11 | 6 1/4 |





OL316R

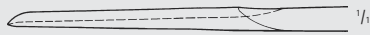

FREER Septum Gouge

| Catalog Number | Tip Size (mm) | Length (in.) |
|----------------|---------------|--------------|
| OL316R | 4 | 6 |



OL318R



COTTLE Septum Gouge

| Catalog Number | Tip Size (mm) | Length (in.) |
|----------------|---------------|--------------|
| OL318R | 6 | 6 |



OL336R



KILLIAN Septum Gouge

| Catalog Number | Tip Size (mm) | Length (in.) |
|----------------|---------------|--------------|
| OL336R | 6 | 6 3/4 |



OL321R



OL322R



OL323R

MASING Osteotome, Single Guarded

| Catalog Number | Blade | Length (in.) |
|----------------|---------|--------------|
| OL321R | LFT-CVD | 7 |
| OL322R | RT-CVD | 7 |
| OL323R | STR | 7 |



Ear/Nose/Throat

Bone Instruments



MB108R

PARKES Hump Gouge

| Catalog Number | Blade | Length (in.) |
|----------------|-------|--------------|
| MB108R | STR | 7 |



OL326R-OL329R

CINELLI Osteotome, Double Guarded

| Catalog Number | Tip Size (mm) | Blade | Length (in.) |
|----------------|---------------|-------|--------------|
| OL326R | 10 | STR | 6 1/4 |
| OL327R | 12 | STR | 6 1/4 |
| OL328R | 14 | STR | 6 1/4 |
| OL329R | 16 | STR | 6 1/4 |



OL326R



OL327R



OL328R



OL329R



OL338R-OL339R

FOMON Osteotome, Single Guarded

| Catalog Number | Tip Size (mm) | Length (in.) |
|----------------|---------------|--------------|
| OL338R | 5 | 6 3/4 |
| OL339R | 8 | 6 3/4 |

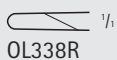

OL338R

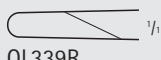

OL339R

ENT

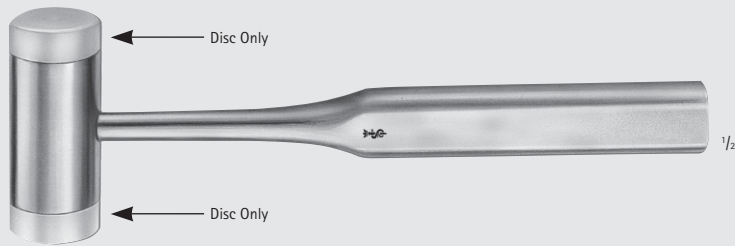

FLO36R-FL037

**Mallet, W/Removable Nylon Discs,
135gr**

| Catalog Number | Item | Diameter (mm) | Length (in.) |
|----------------|------------------------------------|---------------|--------------|
| FLO36R | COMPLETE | 25.0 | 7 1/4 |
| FL037 | NYLON SPARE DISCS, F/FL036R, 2/SET | 25.0 | |



FLO38R

COTTLE Mallet, Flat/Round, 235gr

| Catalog Number | Diameter (mm) | Length (in.) |
|----------------|---------------|--------------|
| FLO38R | 30.0 | 7 1/4 |



DF114R

Strand Mallet, 155gr

| Catalog Number | Diameter (mm) | Length (in.) |
|----------------|---------------|--------------|
| DF114R | 24.0 | 7 1/2 |

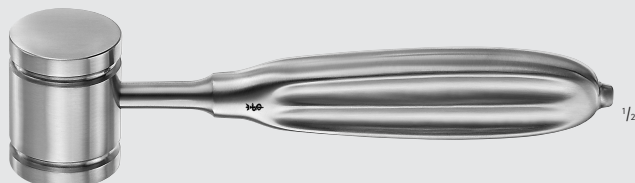

MB303R

CRANE Mallet

| Catalog Number | Length (in.) |
|----------------|--------------|
| MB303R | 6 1/4 |



INCHES

Ear/Nose/Throat

Bone Instruments



FL093R-FL096R $\frac{1}{2}$

Bone Tamper

| Catalog Number | Diameter (mm) | Length (in.) |
|----------------|---------------|--------------|
| FL093R | 3.0 | 6 1/2 |
| FL094R | 5.0 | 6 1/2 |
| FL095R | 7.0 | 6 1/2 |
| FL096R | 9.0 | 6 1/2 |



FL093R



FL094R



FL095R



FL096R



OL448R $\frac{1}{2}$

JOSEPH Nasal Saw

| Catalog Number | Blade Shape | Length (in.) |
|----------------|---------------|--------------|
| OL448R | STR | 7 3/4 |
| OL451R | BAYO, CVD-RT | 7 3/4 |
| OL452R | BAYO, CVD-LFT | 7 3/4 |



OL451R $\frac{1}{2}$



OL452R $\frac{1}{2}$

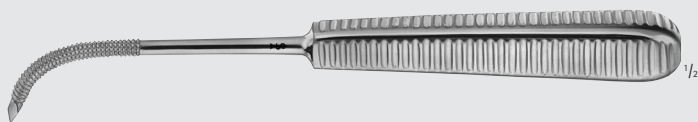

OK804R-OK805R $\frac{1}{2}$

Antrum Rasp

| Catalog Number | Tip | Length (in.) |
|----------------|-------|--------------|
| OK804R | SHARP | 7 |
| OK805R | BLUNT | 7 |



OK804R $\frac{1}{2}$

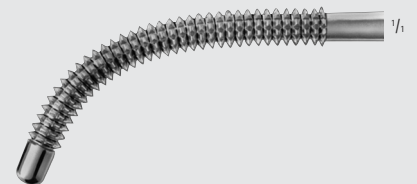

OK805R $\frac{1}{2}$

ENT

MILLIMETERS

Ear/Nose/Throat Bone Instruments



FOMON Bone File, Fine/Coarse

| Catalog Number | Tip Size (mm) | Blade | Length (in.) |
|----------------|---------------|---------|--------------|
| OL405R | 6.5 / 7.5 | DBL-END | 8 1/2 |

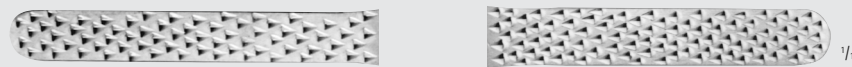

FOMON Bone Rasp, Fine/Coarse

| Catalog Number | Tip Size (mm) | Blade | Length (in.) |
|----------------|---------------|---------|--------------|
| OL406R | 6.5 / 7.5 | DBL-END | 8 1/2 |

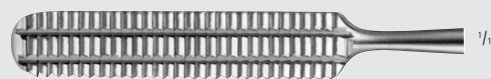

MALTZ Bone Rasp

| Catalog Number | Tip Size (mm) | Tip | Length (in.) |
|----------------|---------------|------------|--------------|
| OL407R | 9 | DWN-STROKE | 7 |



LEWIS Rasp

| Catalog Number | Tip Size (mm) | Tip | Length (in.) |
|----------------|---------------|---------------------------|--------------|
| OL408R | 8 | FINE-SERR DWN-STROKE | 7 |
| OL409R | 8 | COARSE-SERR DWN-STROKE | 7 |



INCHES

Ear/Nose/Throat

Bone Instruments



OL410R-OL411R



OL410R



OL411R



1/2

1/4



1/4

AUFRICHT Rasp

| Catalog Number | Tip Size (mm) | Tip | Length (in.) |
|----------------|---------------|----------|--------------|
| OL410R | 9 | UP-CUT | 8 3/4 |
| OL411R | 9 | DOWN-CUT | 8 3/4 |



MB330R



1/4

PARKES Nasal Rasp, Fine

| Catalog Number | Tip Size (mm) | Length (in.) |
|----------------|---------------|--------------|
| MB330R | 8 | 7 7/8 |



MB110R



1/4

MALTZ-ANDERSON Nasal Rasp

| Catalog Number | Tip Size (mm) | Length (in.) |
|----------------|---------------|--------------|
| MB110R | 6.7 | 6 1/2 |



OL412R



1/4



1/2

GALLAHER File Rasp, Coarse

| Catalog Number | Tip Size (mm) | Length (in.) |
|----------------|---------------|--------------|
| OL412R | 6.5 | 7 1/2 |





■ Rongeur jaw measurement guide

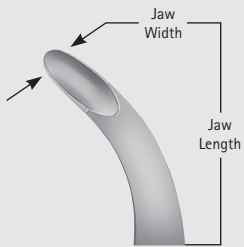

FRIEDMANN Micro Rongeur

| Catalog Number | Jaw Size (mm) | Jaw | Length (in.) |
|----------------|---------------|-----|--------------|
| F0406R | 1.3 x 19.0 | STR | 5 1/2 |
| F0407R | 1.3 x 20.0 | CVD | 5 1/2 |

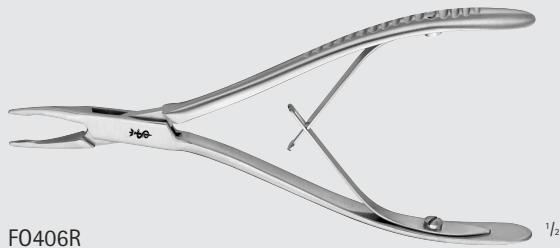

F0406R

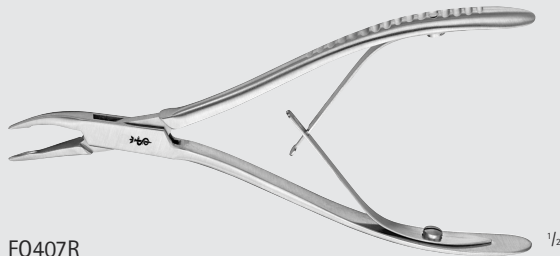

F0407R



LUER-FRIEDMANN Bone Rongeur

| Catalog Number | Jaw Size (mm) | Jaw | Length (in.) |
|----------------|---------------|-----|--------------|
| F0409R | 2.2 x 22.0 | CVD | 5 3/4 |

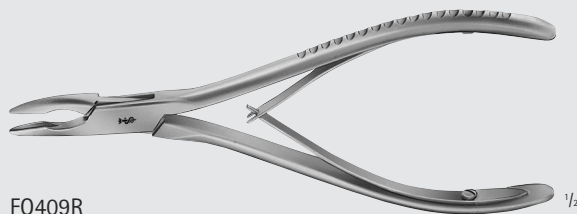

F0409R



Bone Rongeur

| Catalog Number | Jaw Size (mm) | Jaw | Length (in.) |
|----------------|---------------|-----|--------------|
| F0410R | 3.8 x 19.0 | CVD | 5 1/2 |

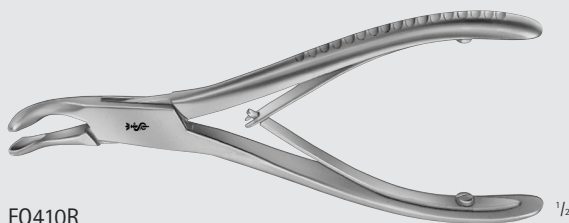

F0410R



Ear/Nose/Throat

Bone Rongeurs

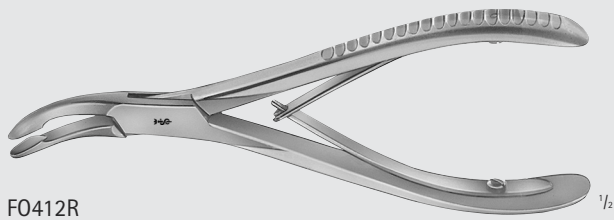

F0412R

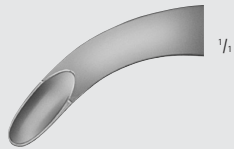

LUER Bone Rongeur

| Catalog Number | Jaw Size (mm) | Jaw | Length (in.) |
|----------------|---------------|-----|--------------|
| F0412R | 4.2 x 26.0 | CVD | 6 |

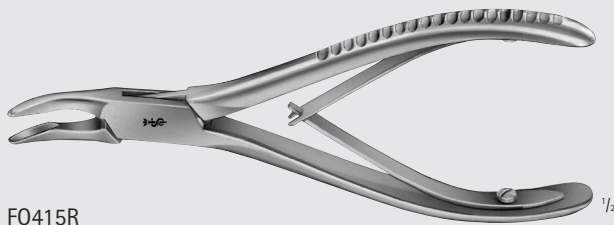

F0415R



BLUMENTHAL Bone Rongeur

| Catalog Number | Jaw Size (mm) | Jaw | Length (in.) |
|----------------|---------------|-----|--------------|
| F0415R | 3.5 x 25.0 | CVD | 6 |



F0440R



ALEXANDER Bone Rongeur

| Catalog Number | Jaw Size (mm) | Jaw | Length (in.) |
|----------------|---------------|-----|--------------|
| F0440R | 3.2 x 27.0 | ANG | 5 1/2 |

JANSEN Bone Rongeur

| Catalog Number | Jaw Size (mm) | Jaw | Length (in.) |
|----------------|---------------|-----|--------------|
| FO430R | 4.2 x 25.0 | STR | 7 |
| FO432R | 4.5 x 30.0 | CVD | 7 |
| FO442R | 3.8 x 37.0 | ANG | 7 1/2 |



FO430R-FO432R



FO430R

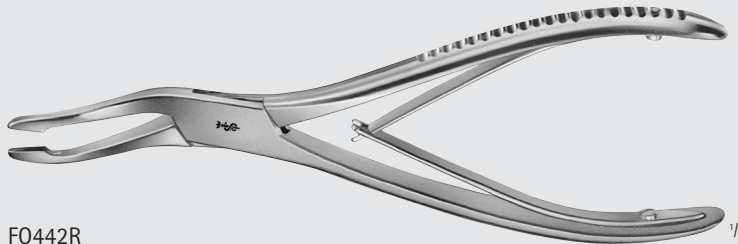

FO442R

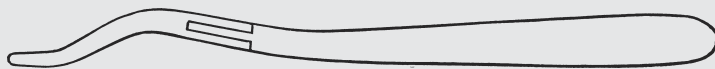

FO432R



LEMPERT Bone Rongeur

| Catalog Number | Jaw Size (mm) | Jaw | Length (in.) |
|----------------|---------------|----------|--------------|
| MD617 | 10 x 22.8 | DEL, STR | 6 1/8 |
| FO450R | 2.2 x 27.0 | STR | 8 |
| FO451R | 2.2 x 26.5 | CVD | 8 |

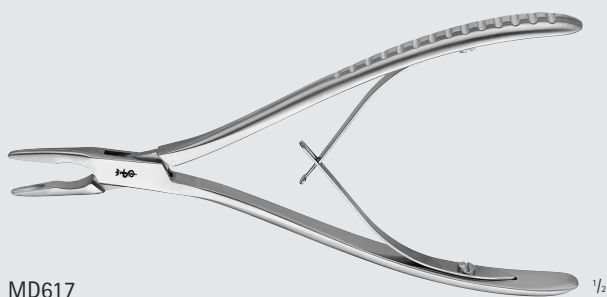

MD617

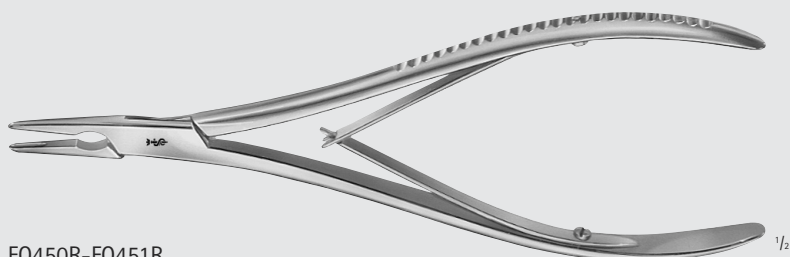

FO450R-FO451R



FO450R



FO451R



INCHES

Ear/Nose/Throat

Bone Rongeurs



F0453R



BEYER Bone Rongeur

| Catalog Number | Jaw Size (mm) | Jaw | Length (in.) |
|----------------|---------------|-----|--------------|
| F0453R | 3.2 x 32.0 | CVD | 7 |

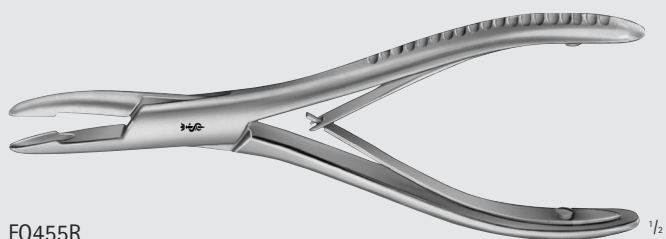

F0455R

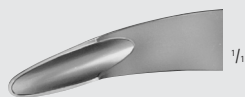

MEAD Bone Rongeur

| Catalog Number | Jaw Size (mm) | Jaw | Length (in.) |
|----------------|---------------|-----|--------------|
| F0455R | 3.5 x 30.0 | CVD | 6 1/2 |

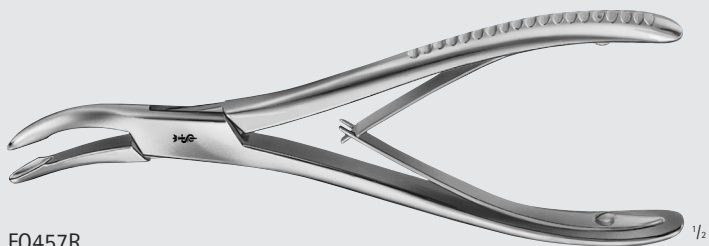

F0457R



BANE-HARTMANN Bone Rongeur

| Catalog Number | Jaw Size (mm) | Jaw | Length (in.) |
|----------------|---------------|-----|--------------|
| F0457R | 4.0 x 32.0 | CVD | 7 |

ENT



FO500R-FO502R



FO500R

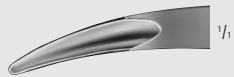

FO502R

BOEHLER Bone Rongeur, Double Action

| Catalog Number | Jaw Size (mm) | Jaw | Jaw End | Length (in.) |
|----------------|---------------|-----|---------|--------------|
| FO500R | 3.0 x 27.0 | CVD | NARR | 6 |
| FO502R | 3.5 x 30.0 | CVD | WIDE | 6 |



FO514R



BEYER Bone Rongeur, Double Action

| Catalog Number | Jaw Size (mm) | Jaw | Length (in.) |
|----------------|---------------|-----|--------------|
| FO514R | 4.0 x 30.0 | CVD | 7 |



FO515R



ZAUFAL-JANSEN Bone Rongeur, Double Action

| Catalog Number | Jaw Size (mm) | Jaw | Length (in.) |
|----------------|---------------|-----|--------------|
| FO515R | 4.5 x 29.0 | CVD | 7 |

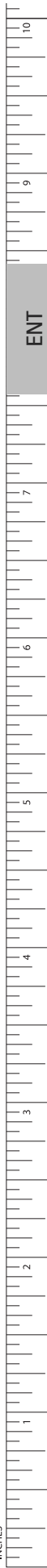

Ear/Nose/Throat

Bone Instruments



FO604R

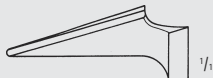

STAMM Bone Cutting Forceps

| Catalog Number | Length (in.) |
|----------------|--------------|
| FO604R | 6 |

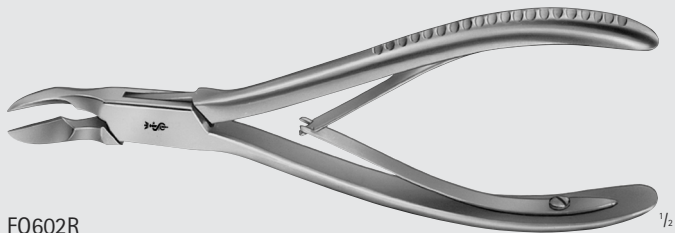

FO602R

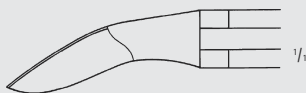

Bone Cutting Forceps

| Catalog Number | Length (in.) |
|----------------|--------------|
| FO602R | 6 3/4 |



FO611R



BOEHLER Bone Cutting Forceps

| Catalog Number | Length (in.) |
|----------------|--------------|
| FO611R | 5 3/4 |



OL151R

PENNINGTON Raspatory

| Catalog Number | Length (in.) |
|----------------|--------------|
| OL151R | 8 1/4 |

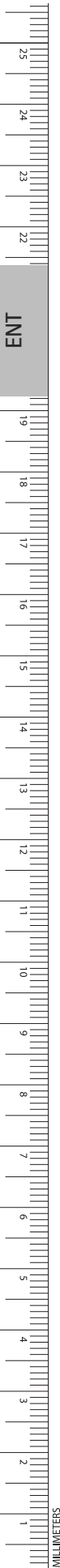

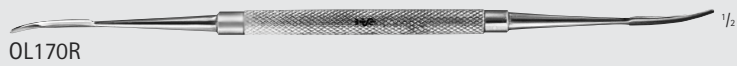

OL170R

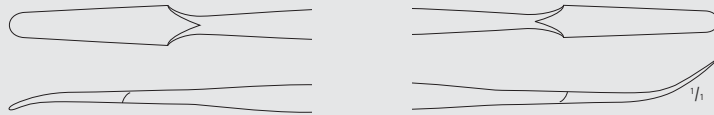

KILLIAN Raspatory

| Catalog Number | Tip | Length (in.) |
|----------------|------------------|--------------|
| OL170R | CVD, SHARP/BLUNT | 7 1/4 |



OL171R

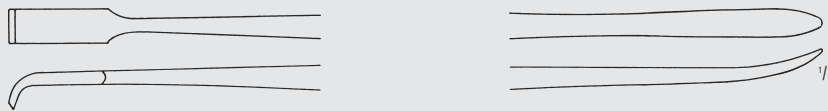

HOWARTH Elevator

| Catalog Number | Tip Size (mm) | Length (in.) |
|----------------|---------------|--------------|
| OL171R | 5 | 8 1/2 |



MB816R

SAYRE Periosteal Elevator

| Catalog Number | Tip | Length (in.) |
|----------------|-------|--------------|
| MB816R | SHARP | 6 3/4 |



OL192R

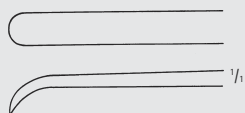

MC KENTY Periosteal Raspatory

| Catalog Number | Tip | Tip Size (mm) | Length (in.) |
|----------------|------------|---------------|--------------|
| OL192R | CVD, SHARP | 4.0 | 6 |



OL198R

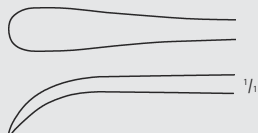

SEWALL Antrum Elevator

| Catalog Number | Tip | Tip Size (mm) | Length (in.) |
|----------------|-------|---------------|--------------|
| OL198R | SHARP | 5.9 | 8 |



OL401R-OL403R



OL401R

JOSEPH Raspatory

| Catalog Number | Tip | Tip Size (mm) | Length (in.) |
|----------------|--------------|---------------|--------------|
| OL401R | FINE, SERR | 7.5 | 6 1/2 |
| OL403R | COARSE, SERR | 9 | 6 1/2 |

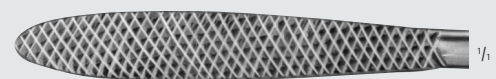

OL403R



Ear/Nose/Throat

Elevators & Currettes

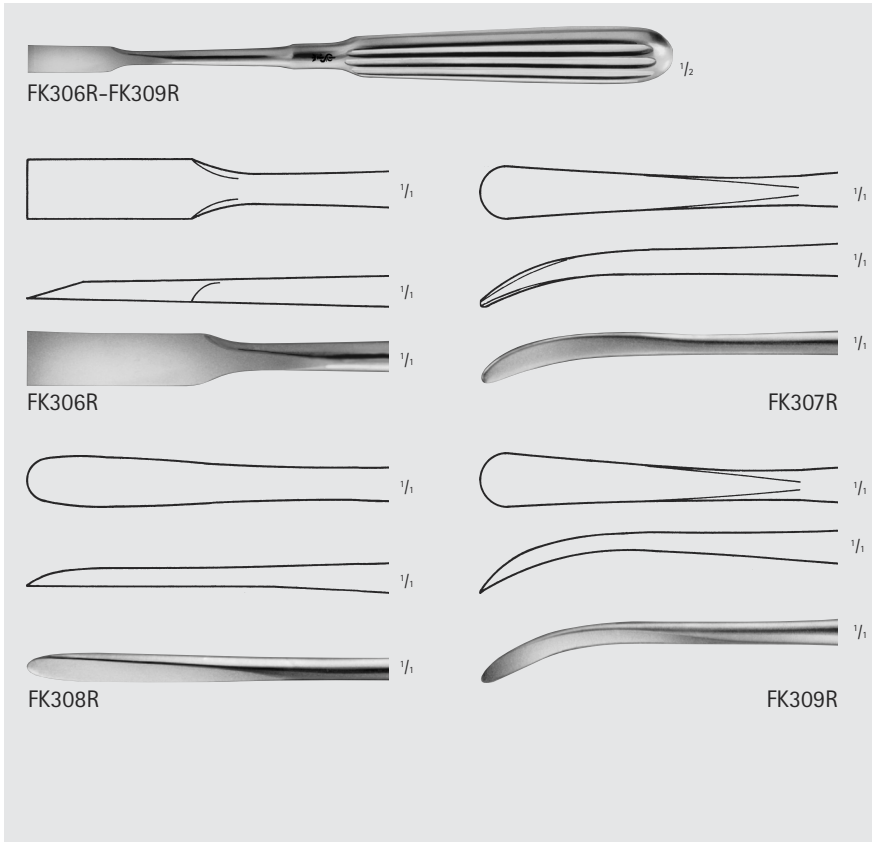

ADSON Elevator

| Catalog Number | Tip | Tip Size (mm) | Blade | Length (in.) |
|----------------|--------|---------------|-------|--------------|
| FK306R | SHARP | 8 | STR | 6 3/4 |
| FK307R | BLUNT | 7 | CVD | 6 3/4 |
| FK308R | SEMI-S | 7 | STR | 6 3/4 |
| FK309R | SHARP | 7 | CVD | 6 3/4 |

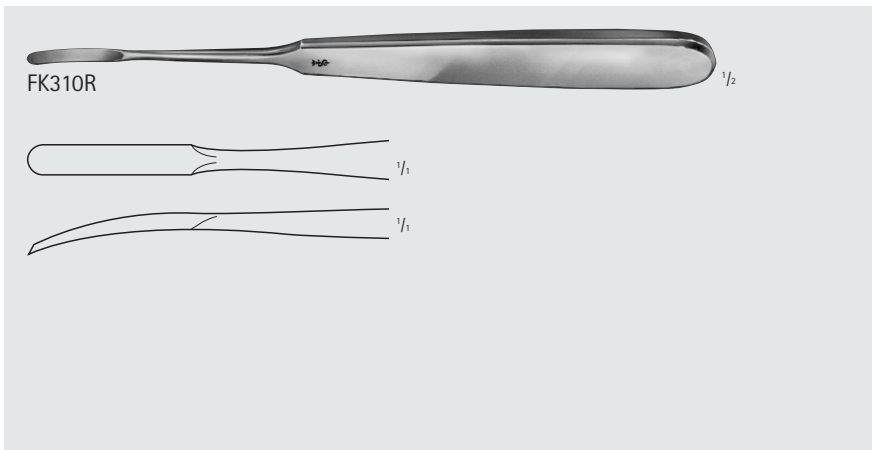

JOSEPH Elevator

| Catalog Number | Tip Size (mm) | Blade | Length (in.) |
|----------------|---------------|---------|--------------|
| FK310R | 4 | SLT-CVD | 7 |

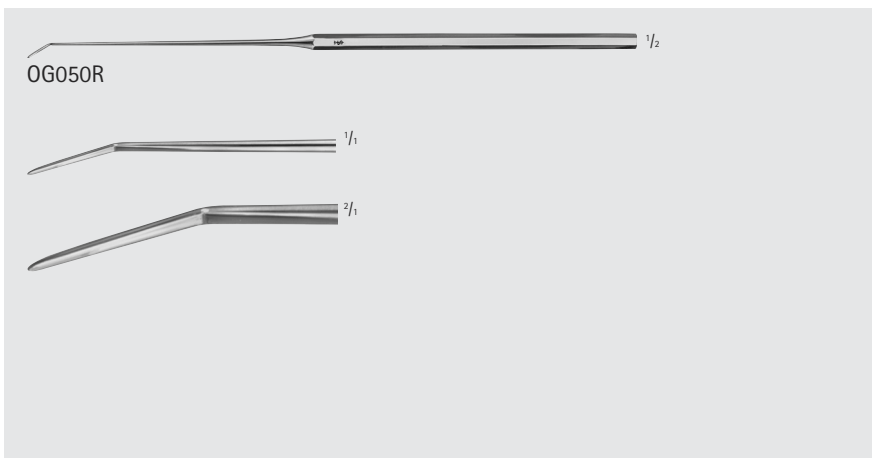

STAPES Elevator

| Catalog Number | Tip Size (mm) | Tip | Length (in.) |
|----------------|---------------|-----|--------------|
| OG050R | 1 | ANG | 6 1/4 |



OL155R

COTTLE Elevator

| Catalog Number | Blade | Length (in.) |
|----------------|---------|--------------|
| OL155R | DBL-END | 8 |



OL152R

COTTLE Elevator, Graduated

| Catalog Number | Blade | Length (in.) |
|----------------|---------|--------------|
| OL152R | DBL-END | 8 |

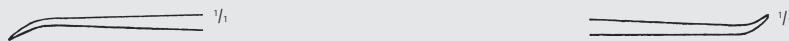

OL153R

MASING Elevator, Graduated

| Catalog Number | Blade | Length (in.) |
|----------------|---------|--------------|
| OL153R | DBL-END | 8 |

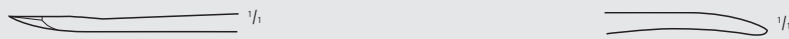

OL157R

COTTLE Periosteal Elevator

| Catalog Number | Tip | Tip Size (mm) | Length (in.) |
|----------------|------------|---------------|--------------|
| OL157R | CVD, SHARP | 8 | 7 3/4 |

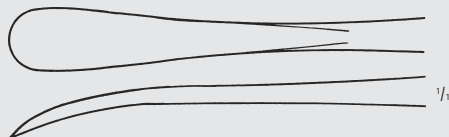

OL160R

HALLE Elevator

| Catalog Number | Tip | Tip Size (mm) | Length (in.) |
|----------------|-------|---------------|--------------|
| OL160R | BLUNT | 3.3 | 7 |

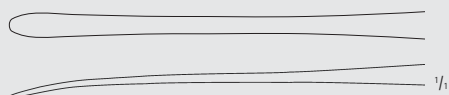

Ear/Nose/Throat

Elevators & Curettes

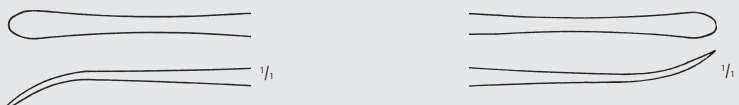
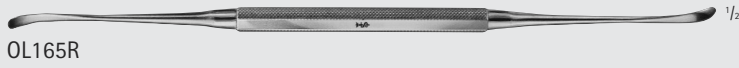
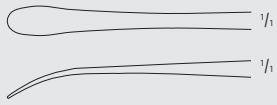
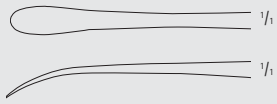
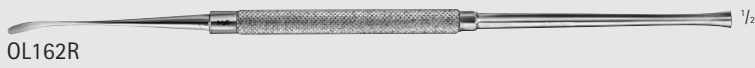

FREER Elevator

| Catalog Number | Tip | Tip Size (mm) | Length (in.) |
|----------------|-------------|---------------|--------------|
| OL162R | SHARP | 4 | 7 1/2 |
| OL163R | BLUNT | 4 | 7 1/2 |
| OL165R | SHARP/BLUNT | 4 / 3.5 | 7 1/4 |

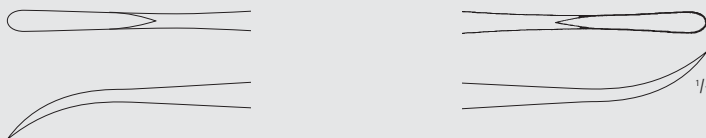
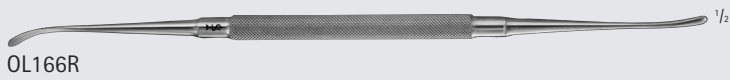

FREER-YASARGIL Elevator

| Catalog Number | Tip | Length (in.) |
|----------------|-------------|--------------|
| OL166R | SHARP/SHARP | 7 1/4 |



BOIES Nasal Fracture Elevator

| Catalog Number | Tip | Length (in.) |
|----------------|-------|--------------|
| OL477R | BLUNT | 7 |

Ear/Nose/Throat Elevators & Curettes

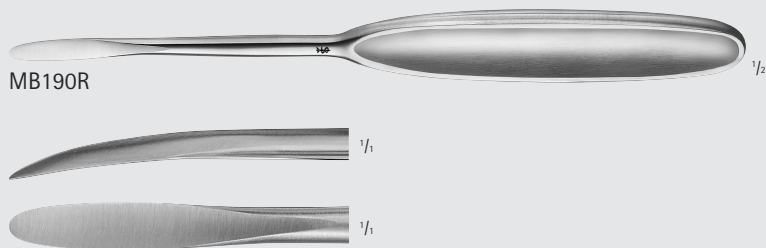

CUSHING Elevator, Narrow

| Catalog Number | Tip | Length (in.) |
|----------------|-------|--------------|
| MB190R | SHARP | 7 3/4 |



GOLDMANN Septum Displacer

| Catalog Number | Length (in.) |
|----------------|--------------|
| OL479R | 8 |



KOENIG Elevator

| Catalog Number | Tip Size (mm) | Blade | Length (in.) |
|----------------|---------------|-------|--------------|
| OM307R | 4.5 | STR | 6 |
| OM308R | 4.5 | CVD | 6 |

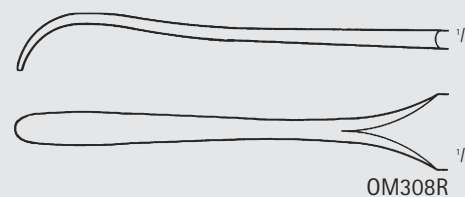

LEMPERT Elevator

| Catalog Number | Tip Size (mm) | Blade | Length (in.) |
|----------------|---------------|-------|--------------|
| OG163R | 3.0 | STR | 6 1/4 |



Curette, Angled-Pointed

| Catalog Number | Blade | Length (in.) |
|----------------|---------|--------------|
| OG189R | DBL-END | 6 3/4 |



Ear/Nose/Throat

Elevators & Curettes



GUILFORD-WRIGHT Micro Bone Curette

| Catalog Number | Blade | Tip Size (mm) | Length (in.) |
|----------------|---------|---------------|--------------|
| MB039R | SLT-ANG | 2.1 x 1.2 | 5 1/8 |



MB039R

PRATT Ethmoid Curette

| Catalog Number | Blade | Length (in.) |
|----------------|-------------------|--------------|
| MB117R | SOLID/FENESTRATED | 9 1/4 |



MB117R

HOUSE Curette

| Catalog Number | Tip Size (mm) | Blade | Length (in.) |
|----------------|---------------|---------|--------------|
| OG181R | 1.0 / 1.2 | DBL-END | 6 |
| OG182R | 1.5 / 1.8 | DBL-END | 6 |
| OG184R | 1.0 / 1.2 | DBL-END | 6 |
| OG185R | 1.5 / 1.8 | DBL-END | 6 |

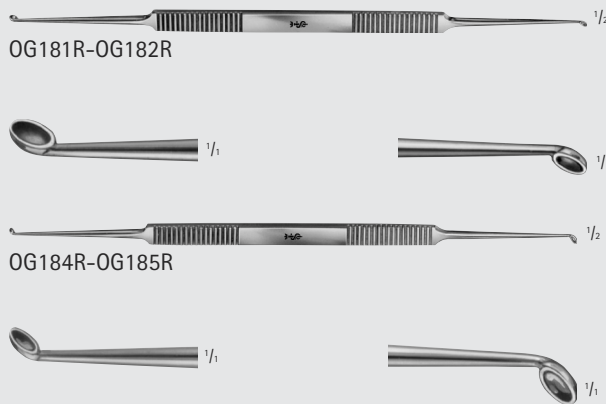

OG181R-OG182R

OG184R-OG185R

MARTINI Bone Curette

| Catalog Number | Tip Size (mm) | Blade | Length (in.) |
|----------------|---------------|---------|--------------|
| FK800R | 3.0 / 3.2 | DBL-END | 5 1/2 |
| FK801R | 4.0 / 3.2 | DBL-END | 5 1/2 |

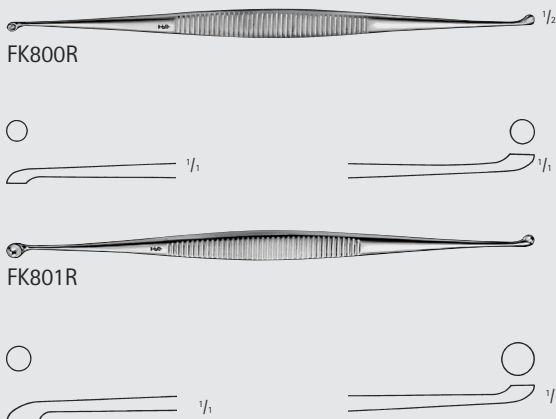

FK800R

FK801R

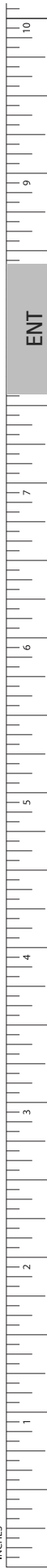

JANSEN Bone Curette

| Catalog Number | Tip Size (mm) | Blade | Length (in.) |
|----------------|---------------|---------|--------------|
| FK803R | 4.3 / 3.6 | DBL-END | 6 1/4 |

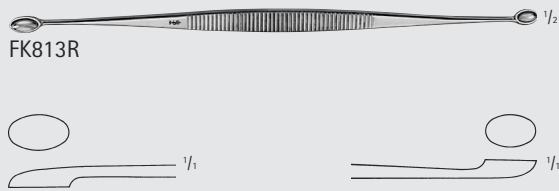

JACOBSON Ear Curette

| Catalog Number | Tip Size (mm) | Blade | Length (in.) |
|----------------|--------------------------|---------|--------------|
| FK813R | 4.3 x 6.5 / 4.5 x 8.5 | DBL-END | 5 1/2 |

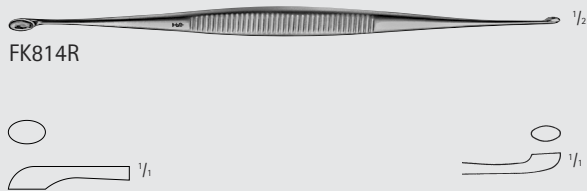

WILLIGER Ear Curette

| Catalog Number | Tip Size (mm) | Blade | Length (in.) |
|----------------|--------------------------|---------|--------------|
| FK814R | 2.0 x 3.5 / 3.0 x 4.5 | DBL-END | 5 3/4 |

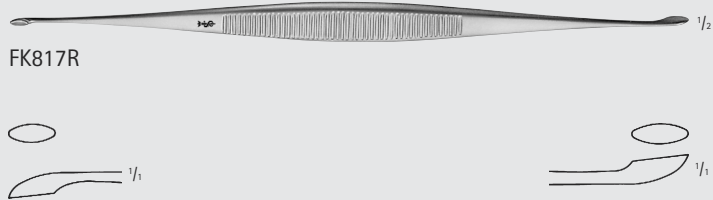

BARTH Ear Curette

| Catalog Number | Tip Size (mm) | Blade | Length (in.) |
|----------------|--------------------------|---------|--------------|
| FK817R | 2.3 x 6.0 / 2.7 x 7.0 | DBL-END | 7 |

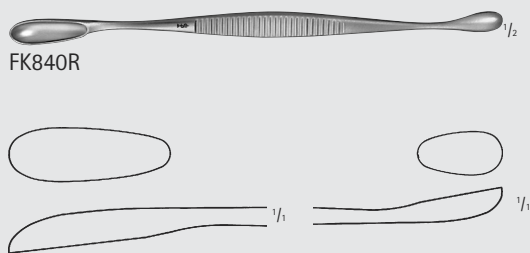

VOLKMANN Bone Curette

| Catalog Number | Tip Size (mm) | Blade | Length (in.) |
|----------------|----------------------------|---------|--------------|
| FK840R | 7.5 x 21.0 / 6.0 x 11.0 | DBL-END | 5 1/8 |
| FK842R | 7.5 x 21.0 / 6.0 x 11.0 | DBL-END | 6 3/4 |

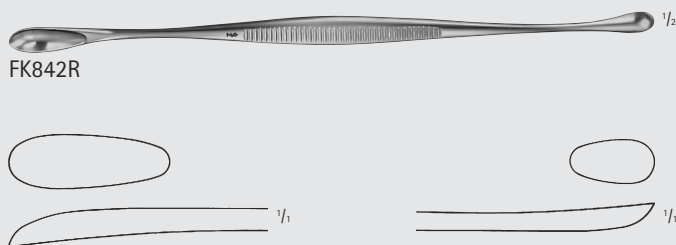

Ear/Nose/Throat

Elevators & Curettes



FK611R-FK617R

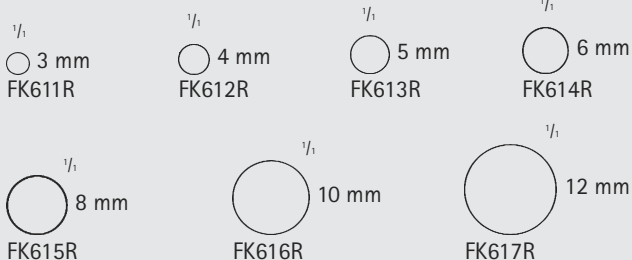

BRUNS Curette

| Catalog Number | Tip | Tip Size (mm) | Length (in.) |
|----------------|------|---------------|--------------|
| FK611R | #000 | 3 | 6 1/2 |
| FK612R | #00 | 4 | 6 1/2 |
| FK613R | #0 | 5 | 6 1/2 |
| FK614R | #1 | 6 | 6 1/2 |
| FK615R | #2 | 8 | 6 1/2 |
| FK616R | #3 | 10 | 6 1/2 |
| FK617R | #4 | 12 | 6 1/2 |



FK621R-FK627R



SCHEDE Curette

| Catalog Number | Tip | Tip Size (mm) | Length (in.) |
|----------------|------|---------------|--------------|
| FK621R | #000 | 2.5 | 6 3/4 |
| FK622R | #00 | 3.4 | 6 3/4 |
| FK623R | #0 | 4.2 | 6 3/4 |
| FK624R | #1 | 5.2 | 6 3/4 |
| FK625R | #2 | 6.3 | 6 3/4 |
| FK626R | #3 | 7.4 | 6 3/4 |
| FK627R | #4 | 8.0 | 6 3/4 |

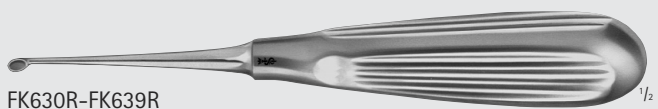

FK630R-FK639R

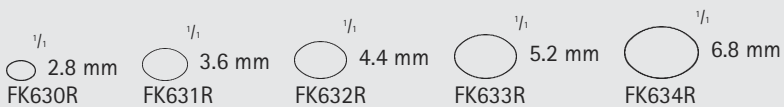

VOLKMANN Curette

| Catalog Number | Tip | Tip Size (mm) | Length (in.) |
|----------------|-------|---------------|--------------|
| FK630R | #0000 | 2.8 | 6 3/4 |
| FK631R | #000 | 3.6 | 6 3/4 |
| FK632R | #00 | 4.4 | 6 3/4 |
| FK633R | #0 | 5.2 | 6 3/4 |
| FK634R | #1 | 6.8 | 6 3/4 |
| FK635R | #2 | 8.5 | 6 3/4 |
| FK636R | #3 | 10.0 | 6 3/4 |
| FK637R | #4 | 11.5 | 6 3/4 |
| FK638R | #5 | 13.0 | 6 3/4 |
| FK639R | #6 | 14.5 | 6 3/4 |

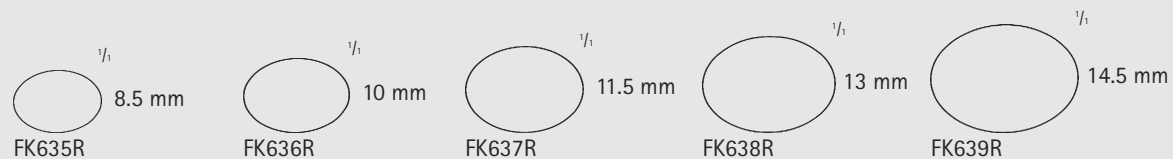



FK658R-FK659R



$\frac{1}{8}$
3.4 mm
FK658R

$\frac{1}{8}$
5.2 mm
FK659R

WILLIGER Bone Curette

| Catalog Number | Tip | Tip Size (mm) | Length (in.) |
|----------------|-----|---------------|--------------|
| FK658R | #00 | 3.4 mm | 6 3/4 |
| FK659R | #1 | 5.2 mm | 6 3/4 |



OK811R-OK816R



OK811R



OK814R



OK812R



OK815R



OK813R



OK816R

COAKLEY Sinus Curette

| Catalog Number | Blade | Length (in.) |
|----------------|---------|--------------|
| OK811R | SLT-ANG | 6 3/4 |
| OK814R | SLT-ANG | 6 3/4 |
| OK812R | 45° | 6 3/4 |
| OK815R | 45° | 6 3/4 |
| OK813R | REV-ANG | 6 3/4 |
| OK816R | 45° | 6 3/4 |



INCHES

Ear/Nose/Throat

Elevators & Currettes



OM451R-OM456R

BECKMANN Adenoid Curette

| Catalog Number | Length (in.) |
|----------------|--------------|
| OM451R | 8 |
| OM453R | 8 |
| OM455R | 8 |
| OM452R | 8 |
| OM454R | 8 |
| OM456R | 8 |

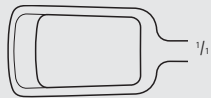

OM451R

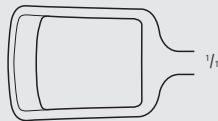

OM453R

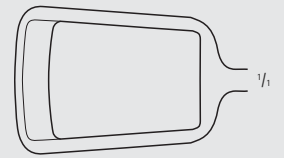

OM455R

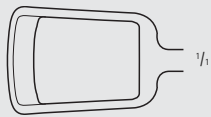

OM452R

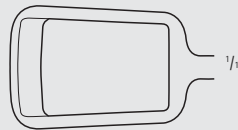

OM454R

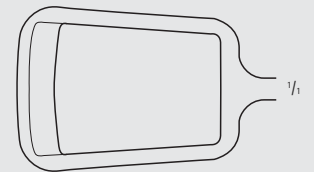

OM456R



OM471R-OM474R

BARNHILL Adenoid Curette

| Catalog Number | Length (in.) |
|----------------|--------------|
| OM471R | 8 |
| OM472R | 8 |
| OM473R | 8 |
| OM474R | 8 |



OM471R



OM472R



OM473R



OM474R

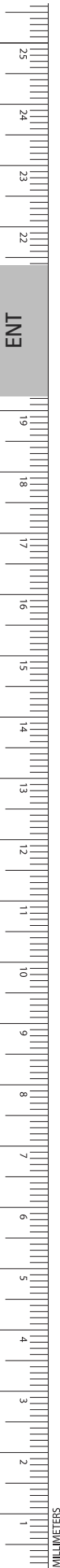



OM500R-OM514R



BECKMANN
OM500R - OM505R

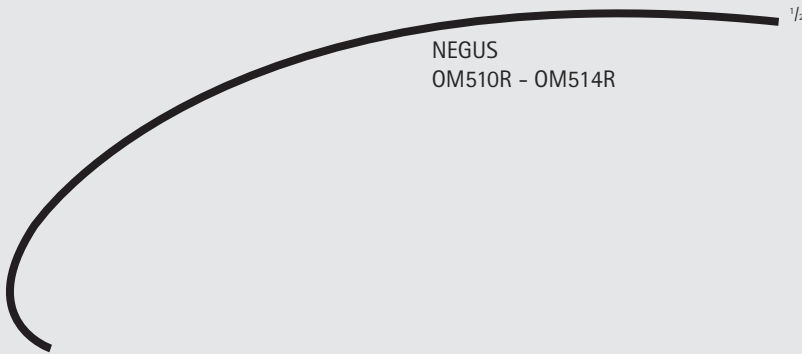

NEGUS
OM510R - OM514R

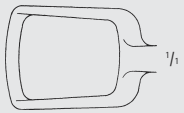

OM500R

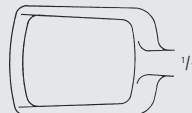

OM501R

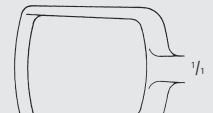

OM502R

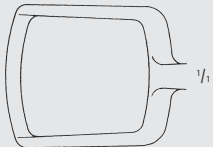

OM503R

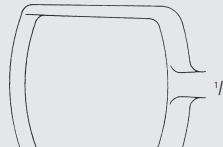

OM504R

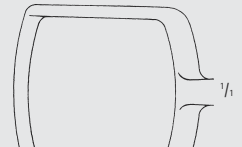

OM505R

Adenoid Curette

| Catalog Number | Blade | Length (in.) |
|----------------|---------|--------------|
| OM500R | CVD | 8 |
| OM501R | CVD | 8 |
| OM502R | CVD | 8 |
| OM503R | CVD | 8 |
| OM504R | CVD | 8 |
| OM505R | CVD | 8 |
| OM510R | REV-CVD | 8 |
| OM511R | REV-CVD | 8 |
| OM512R | REV-CVD | 8 |
| OM513R | REV-CVD | 8 |
| OM514R | REV-CVD | 8 |



MB316R



Vogel Adenoid Curette

| Catalog Number | Size | Length (in.) |
|----------------|--------------|--------------|
| MB316R | INFANT, 7 mm | 8 1/2 |

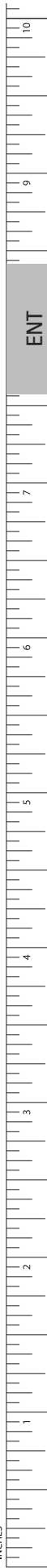

INCHES

Ear/Nose/Throat

Elevators & Currettes



OF268R



SNELLEN Ear Curette

| Catalog Number | Tip | Blade | Length (in.) |
|----------------|------|-------|--------------|
| OF268R | SERR | CVD | 6 1/4 |



OF271R-OF272R



OF271R



OF272R

BILLEAU Ear Loop

| Catalog Number | Tip | Length (in.) |
|----------------|-------|--------------|
| OF271R | SMALL | 6 1/4 |
| OF272R | LARGE | 6 1/4 |



OF350R-OF354R

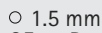
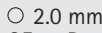
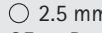
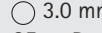
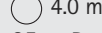

- $\frac{1}{4}$

 1.5 mm
 OF350R
- $\frac{1}{4}$

 2.0 mm
 OF351R
- $\frac{1}{4}$

 2.5 mm
 OF352R
- $\frac{1}{4}$

 3.0 mm
 OF353R
- $\frac{1}{4}$

 4.0 mm
 OF354R

BUCK Ear Curette, Sharp

| Catalog Number | Tip | Tip Size (mm) | Blade | Length (in.) |
|----------------|-----|---------------|-------|--------------|
| OF350R | #00 | 1.5 | CVD | 6 |
| OF351R | #0 | 2.0 | CVD | 6 |
| OF352R | #1 | 2.5 | CVD | 6 |
| OF353R | #2 | 3.0 | CVD | 6 |
| OF354R | #3 | 4.0 | CVD | 6 |



OF355R-OF359R

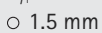
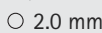
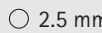
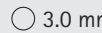
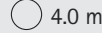

- $\frac{1}{4}$

 1.5 mm
 OF355R
- $\frac{1}{4}$

 2.0 mm
 OF356R
- $\frac{1}{4}$

 2.5 mm
 OF357R
- $\frac{1}{4}$

 3.0 mm
 OF358R
- $\frac{1}{4}$

 4.0 mm
 OF359R

BUCK Ear Curette, Blunt

| Catalog Number | Tip | Tip Size (mm) | Blade | Length (in.) |
|----------------|-----|---------------|-------|--------------|
| OF355R | #00 | 1.5 | CVD | 6 |
| OF356R | #0 | 2.0 | CVD | 6 |
| OF357R | #1 | 2.5 | CVD | 6 |
| OF358R | #2 | 3.0 | CVD | 6 |
| OF359R | #3 | 4.0 | CVD | 6 |





OK711R-OK712R

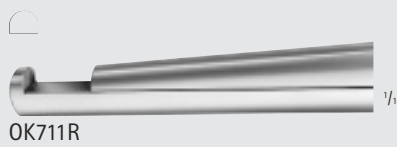

OK711R



OK712R

KERRISON Rongeur

| Catalog Number | Jaw Size (mm) | Jaw | Length (in.) |
|----------------|---------------|--------|--------------|
| OK711R | 4.0 | 90°-UP | 3 3/8" |
| OK712R | 5.0 | 90°-UP | 3 3/8" |

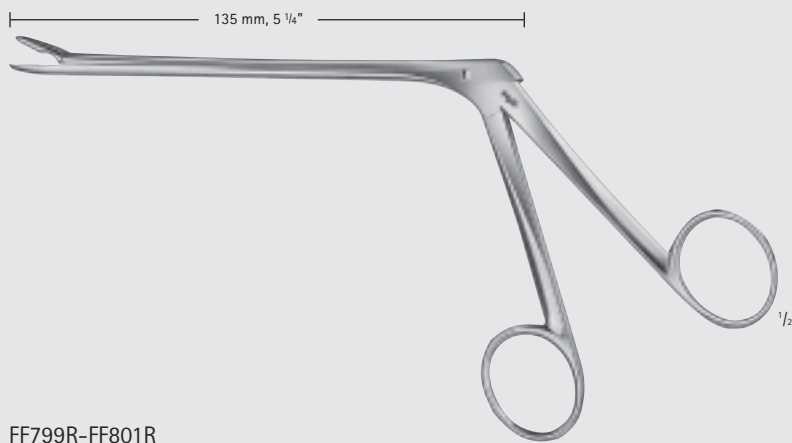

FF799R-FF801R

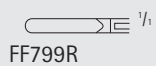

FF799R



FF800R



FF801R

Rongeur

| Catalog Number | Author | Jaw Size (mm) | Jaw | Length (in.) |
|----------------|----------------|---------------|-----|--------------|
| FF799R | LOVE-GRUENWALD | 2 x 10 | STR | 5 1/8 |
| FF800R | LOVE-GRUENWALD | 3 x 10 | STR | 5 1/8 |
| FF801R | SPURLING | 4 x 10 | STR | 5 1/8 |



INCHES

Ear/Nose/Throat

Rongeurs

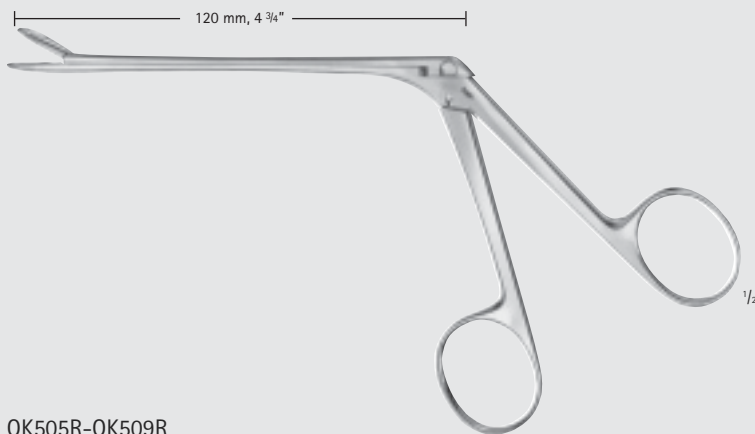

WEIL-BLAKESLEY Rongeur

| Catalog Number | Jaw Size (mm) | Jaw | Length (in.) |
|----------------|---------------|-------------|--------------|
| OK505R | 3.0 | STR | 4 3/4" |
| OK506R | 3.6 | STR | 4 3/4" |
| OK507R | 4.2 | STR | 4 3/4" |
| OK508R | 4.8 | STR | 4 3/4" |
| OK509R | 5.6 | STR | 4 3/4" |
| OK520R | 3.6 | 140°-UP-CVD | 4 1/2" |
| OK521R | 4.2 | 140°-UP-CVD | 4 1/2" |
| OK522R | 4.8 | 140°-UP-CVD | 4 1/2" |

OK505R-OK509R



OK505R



OK506R



OK507R



OK508R



OK509R

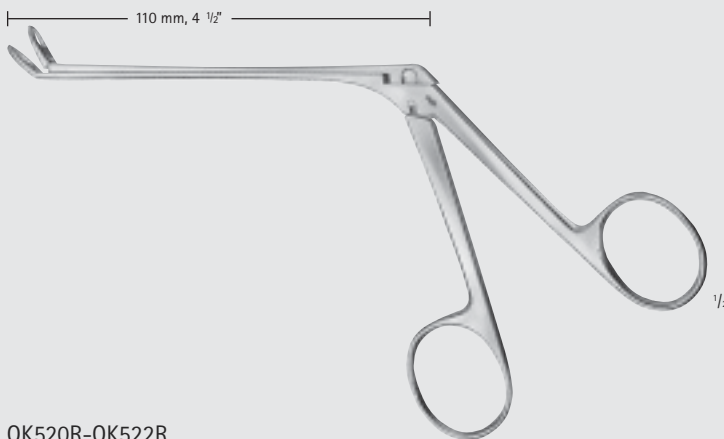

OK520R-OK522R



OK520R



OK521R



OK522R

TAKAHASHI Rongeur

| Catalog Number | Jaw Size (mm) | Jaw | Length (in.) |
|----------------|---------------|---------|--------------|
| OK525R | 3.0 | STR | 4 3/4" |
| OK526R | 3.0 | 130°-UP | 4 3/4" |

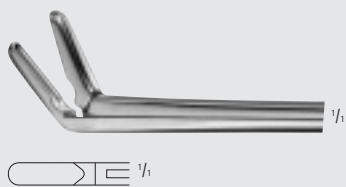
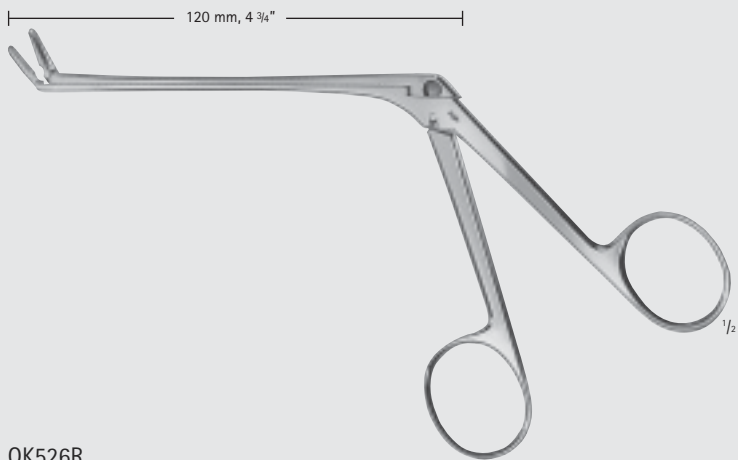
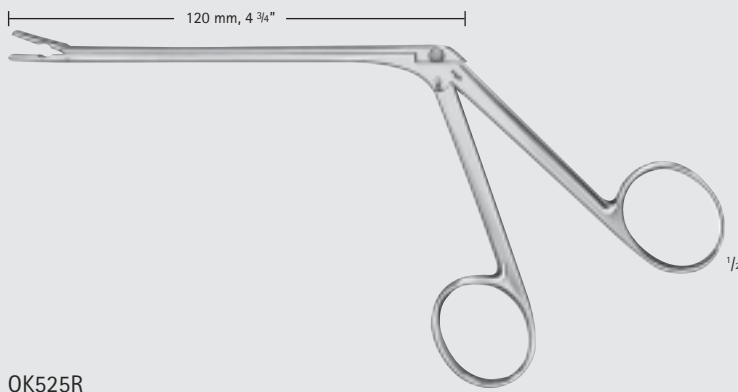

WATSON-WILLIAMS Ethmoidal Forceps

| Catalog Number | Jaw | Length (in.) |
|----------------|-----------|--------------|
| OK530R | STR, SERR | 4 3/4" |



Ear/Nose/Throat

Rongeurs



GRUENWALD-HENKE Nasal Cut Rongeur

| Catalog Number | Jaw | Length (in.) |
|----------------|-------|--------------|
| OK612R | SMALL | 4 3/4" |
| OK613R | LARGE | 4 3/4" |

OK612R-OK613R

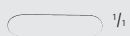

 1/4
OK612R

 1/4
OK613R

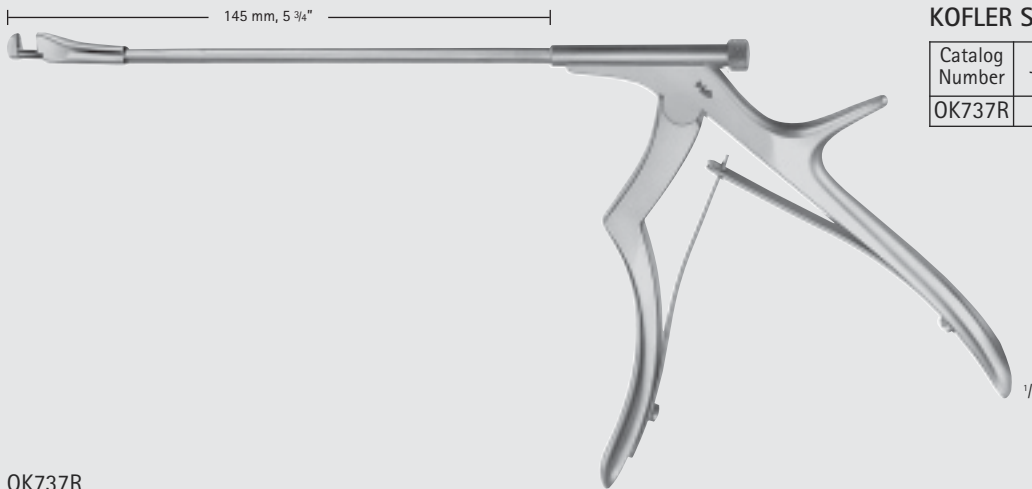

KOFLER Sinus Punch, Rotatable

| Catalog Number | Jaw Size (mm) | Jaw | Length (in.) |
|----------------|---------------|-----|--------------|
| OK737R | 3.0 | 90° | 5 3/4" |

OK737R



HAJEK-KOFLER Punch

| Catalog Number | Jaw Size (mm) | Jaw | Length (in.) |
|----------------|---------------|---------|--------------|
| OK740R | 3.3 | 90°-UP | 5 1/2 |
| OK742R | 4.0 | 90°-UP | 5 1/2 |
| OK741R | 3.3 | 90°-DWN | 5 1/2 |

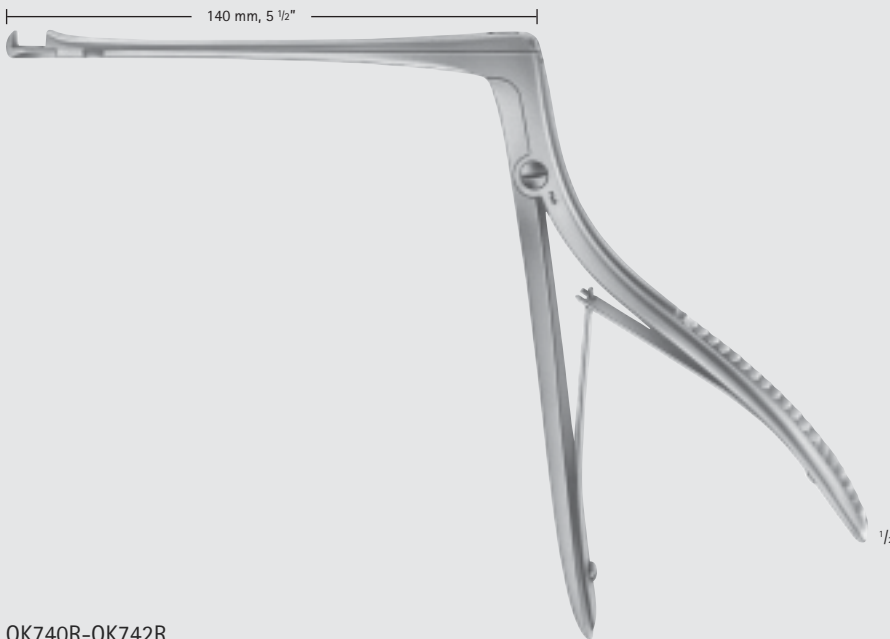

OK740R-OK742R



OK740R



OK742R



OK741R



Ear/Nose/Throat

Rongeurs



HAJEK-KOFLER Punch, Rotatable

| Catalog Number | Jaw Size (mm) | Jaw | Length (in.) |
|----------------|---------------|--------------|--------------|
| OK745R | 4.0 | ROTATES 360° | 6 3/4 |

OK745R



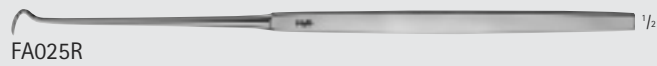

FA025R



FA026R



BOSE Tracheal Hook

| Catalog number | Tip | Length (in.) |
|----------------|---------|--------------|
| FA025R | CVD-LFT | 6 1/2 |
| FA026R | CVD-RT | 6 1/2 |



BT103R-BT107R



BT103R



BT106R



BT107R

Tracheal Retractor

| Catalog Number | Tip | Length (in.) |
|----------------|-------|--------------|
| BT103R | SHARP | 7 |
| BT106R | BLUNT | 7 |
| BT107R | BLUNT | 7 |



MB230



JACKSON Tracheal Retractors

| Catalog Number | Length (in.) |
|----------------|--------------|
| MB230 | 7 |



MB736R



JACKSON Tracheal Tenaculum

| Catalog Number | Length (in.) |
|----------------|--------------|
| MB736R | 5 1/4 |

Ear/Nose/Throat

Accessories



FA005R

TROUSSEAU Tracheal Dilator

| Catalog Number | Length (in.) |
|----------------|--------------|
| FA005R | 4 3/4 |

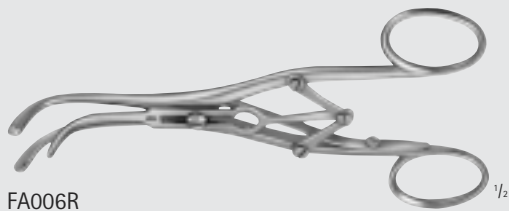

FA006R

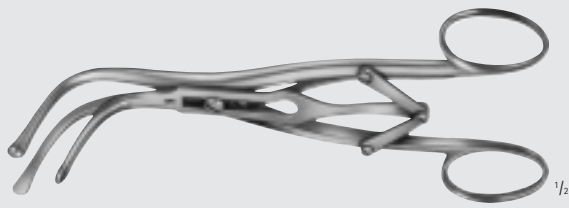

FA007R

LABORDE Tracheal Dilator

| Catalog Number | Length (in.) |
|----------------|--------------|
| FA006R | 5 |
| FA007R | 5 1/4 |



AC481R

Laryngeal Mirror Handle

| Catalog Number | Length (in.) |
|----------------|--------------|
| AC481R | 4 3/8 |

ENT

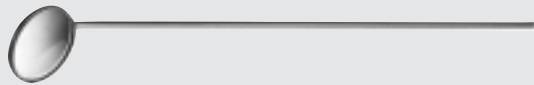

AC468R-AC480R



AC468R



AC469R



AC470R



AC471R

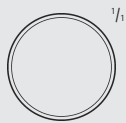

AC472R

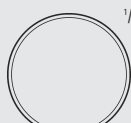

AC473R



AC474R



AC475R

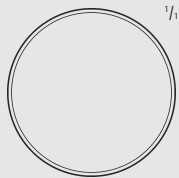

AC476R

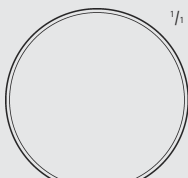

AC477R

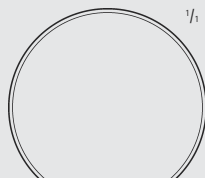

AC478R

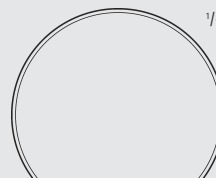

AC479R

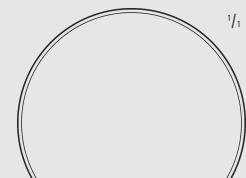

AC479R

Laryngeal Mirror, Rigid

| Catalog Number | Size | Diameter (mm) | Length (in.) |
|----------------|------|---------------|--------------|
| AC468R | 000 | 6.0 | 4 3/4 |
| AC469R | 00 | 8.0 | 4 3/4 |
| AC470R | 0 | 10.0 | 4 3/4 |
| AC471R | 1 | 12.0 | 4 3/4 |
| AC472R | 2 | 15.0 | 4 3/4 |
| AC473R | 3 | 16.0 | 4 3/4 |
| AC474R | 4 | 18.0 | 4 3/4 |
| AC475R | 5 | 20.0 | 4 3/4 |
| AC476R | 6 | 22.0 | 4 3/4 |
| AC477R | 7 | 24.0 | 4 3/4 |
| AC478R | 8 | 26.0 | 4 3/4 |
| AC479R | 9 | 28.0 | 4 3/4 |
| AC480R | 10 | 30.0 | 4 3/4 |

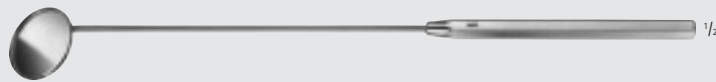

OM078R-OM090R



OM078R



OM079R



OM080R



OM081R

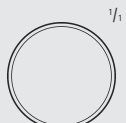

OM082R



OM083R



OM084R

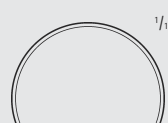

OM085R

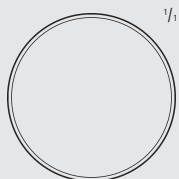

OM086R

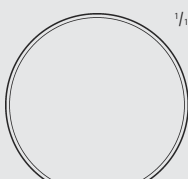

OM087R

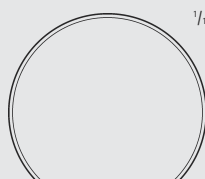

OM088R

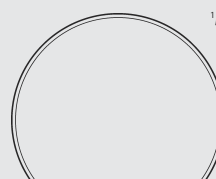

OM089R

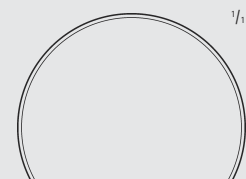

OM090R

Laryngeal Mirror, Rigid, W/Hex Handle

| Catalog Number | Size | Diameter (mm) | Length (in.) |
|----------------|------|---------------|--------------|
| OM078R | 000 | 6.0 | 7 |
| OM079R | 00 | 8.0 | 7 |
| OM080R | 0 | 10.0 | 7 |
| OM081R | 1 | 12.0 | 7 |
| OM082R | 2 | 14.0 | 7 |
| OM083R | 3 | 16.0 | 7 |
| OM084R | 4 | 18.0 | 7 |
| OM085R | 5 | 20.0 | 7 |
| OM086R | 6 | 22.0 | 7 |
| OM087R | 7 | 24.0 | 7 |
| OM088R | 8 | 26.0 | 7 |
| OM089R | 9 | 28.0 | 7 |
| OM090R | 10 | 30.0 | 7 |

Ear/Nose/Throat

Accessories



OF090

ZIEGLER Head Mirror, Only

| Catalog Number | Diameter (mm) |
|----------------|---------------|
| OF090 | 90 |



AC413-AC414

ZIEGLER Head Band, Only

| Catalog Number | Material |
|----------------|----------------|
| AC413 | PLASTIC, BLACK |
| AC414 | PLASTIC, WHITE |



AC415

MURPHY Head Band, Only

| Catalog Number | Material |
|----------------|----------------|
| AC415 | PLASTIC, WHITE |



AC421

Head Mirror W/Head Band

| Catalog Number | Item |
|----------------|--------------------|
| AC421 | HEAD BAND W/MIRROR |

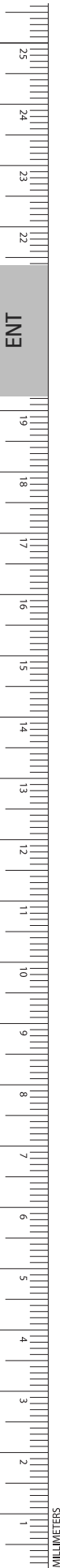



OF001N-OF006N

HARTMANN Tuning Fork

| Catalog Number | Frequency |
|----------------|-----------|
| OF001N | c 128 |
| OF002N | c1 256 |
| OF003N | c2 512 |
| OF004N | c3 1024 |
| OF005N | c4 2048 |
| OF006N | c5 4096 |

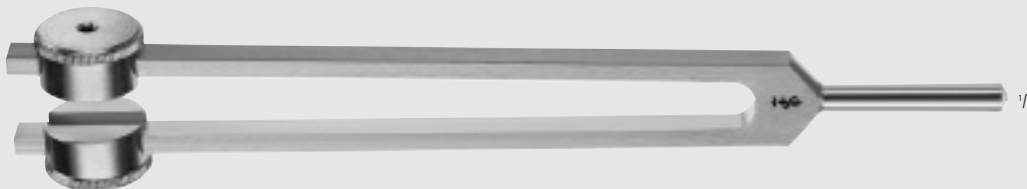

MB575A

HARTMANN Tuning Fork

| Catalog Number | Frequency |
|----------------|-----------|
| MB575A | C64 |



OG145R

Surgery Preparation Base, W/MM-Scale

| Catalog Number | Dimensions (mm) |
|----------------|-----------------|
| OG145R | 92 x 54 |

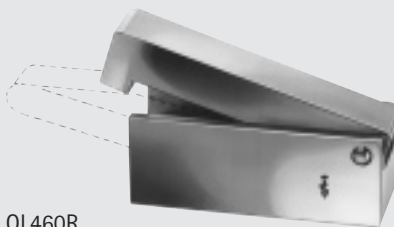

OL460R

Bone & Cartilage Crusher, W/Clamp

| Catalog Number |
|----------------|
| OL460R |



ENT

INCHES

Ear/Nose/Throat

Micro Scissors



OC498R-OC500R



OC498R



OC499R

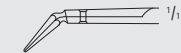

OC500R

VANNAS Micro Scissors

| Catalog Number | Handle | Blade | Length (in.) |
|----------------|---------------|-------|--------------|
| OC498R | FLAT, GROOVED | STR | 3 3/8 |
| OC499R | FLAT, GROOVED | CVD | 3 3/8 |
| OC500R | FLAT, GROOVED | ANG | 3 3/8 |



OC480R



MC CLURE Micro Scissors

| Catalog Number | Handle | Blade | Length (in.) |
|----------------|---------------|-------|--------------|
| OC480R | FLAT, GROOVED | STR | 3 3/4 |

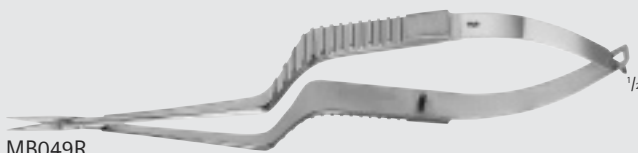

MB049R

WIET Bayonet Otologic Scissors

| Catalog Number | Blade | Length (in.) |
|----------------|-------|--------------|
| MB049R | STR | 6 1/2 |

