

Aesculap Surgical Instruments Product Catalog



AESCULAP®





Aesculap Surgical Instruments Product Catalog



Aesculap Vision, Mission, Values and Cultural Beliefs



Our Vision

Through collaborative excellence we will improve the quality of a patient's life and meet the needs of the changing healthcare environment.

Our Mission

We are committed to achieving collaborative excellence, through a culture of "Sharing Expertise" among our employees, partners, providers and patients. We take responsibility as an organization and as individuals to create a climate of trust, ethics and accountability.



We are part of a global, family owned organization with a proud heritage that is passionately committed to providing high quality, innovative products and services to all surgical disciplines, with particular focus in the fields of General, Neuro, Spine and Orthopaedics.

We are committed to a long term perspective of sustainable growth. Our growth is financed by our internal resources and innovative strength, and our commitment is to uphold this

directive for the future generations of our employees, healthcare partners and through them, our patients.

Our Values

Our values are the foundation upon which our culture is built. They are the standard that every employee is held to, regardless of title, job function or responsibility. Embodying these values, in our everyday work lives, is the key to fostering a culture of collaboration and ensuring our long term success as a company.

-  **INTEGRITY and HONESTY**
-  **QUALITY and EFFICIENCY**
-  **RESPONSIBILITY TO OUR EMPLOYEES**
-  **ACCOUNTABILITY**
-  **INNOVATION**
-  **SUSTAINABILITY**

Aesculap U.S. Headquarters



Aesculap U.S. Headquarters

Our U.S. Headquarters, located in Center Valley, Pennsylvania, was established in 1977 to serve the needs of the U.S. market.

Should you have any need or questions, our customer service professionals welcome your call.

Aesculap holds customers and patients to the highest level in our core values. Our commitment is to exceed your expectations.

Please call customer service for:

- Placing orders
- Product information
- Pricing

Aesculap, Inc.
3773 Corporate Parkway
Center Valley, PA 18034
Phone 800-258-1946
Fax 610-791-6880
www.aesculapusa.com

Customer Service:

Phone: **800-282-9000**

Fax: **610-791-6886**

Commitment to Quality



A Heritage of Quality for 150 years



Gottfried Jetter

Aesculap, the world's largest manufacturer of surgical instruments, has been crafting high performance instruments in Tuttlingen, Germany since 1867. Named

for the Greek god of healing, Asklepios, the company was founded by Gottfried Jetter, the first person ever to produce standardized surgical instruments.

Today, Aesculap employs nearly 12,000 people in our modern, Aesculap-owned and operated factories around the world, including 3,500 people in the Tuttlingen facilities which house over 450,000 square feet of production area.

PERFORMANCE QUALITY Surgical Instruments Made by Aesculap

For every surgical instrument *Made by Aesculap* we demand not just "Quality", but *PERFORMANCE QUALITY*. A surgical instrument with *PERFORMANCE QUALITY* is meticulously crafted to have a solid feel and to perform like an extension of the surgeon's own hand. To deliver *PERFORMANCE QUALITY* worthy of the Aesculap name, we start with the finest, raw materials including highly pure stainless steel which is purchased and tested in Tuttlingen. Our master craftsmen, who are among the most rigorously trained and experienced in the industry, then follow the strictest standards when crafting each instrument, including:

- **State-of-the-art German-made equipment** which is used in every Aesculap-owned factory worldwide
- **Aesculap hand-crafted, Gold-Plated Master QC Standards** that assure pattern consistency
- **Strict Aesculap manufacturing guidelines**, including tight tolerances more strict than International Quality Standards, for precision and reliability from first use and throughout the lifetime of each instrument

As our Mission states, we are "passionately committed to providing high quality, innovative products and services to all surgical disciplines."

Aesculap product range:

- Surgical instruments for all disciplines
- Sterile containers
- Endoscopy
- Neuroendoscopy
- Aneurysm clips
- Power systems
- Pneumatic KAIRisons
- Spinal implants
- Orthopedics
- Per-procedure programs
- Repair services
- Consulting services
- Dura substitutes
- Hydrocephalus

Aesculap Academy



An Overview of the Aesculap Academy

Competence to Master the Future

An unprecedented demand for medical know-how exists today. Innovative developments in the field of medical technology, sophisticated new treatment methods, increasingly more stringent requirements for hospital and quality management and a healthy interest in acquiring new knowledge have given rise to an enormous and ever-increasing demand for additional training.



Sharing Knowledge for Life

The Aesculap Academy enjoys a worldwide reputation as a leading forum for basic and advanced training in the field of medicine. Since 1995, it has offered accredited and non-accredited medical education. Aesculap Academy programs provide knowledge to medical practitioners, hospital personnel and hospital management personnel to master the future. Reaching across borders, cultures and languages, the Aesculap Academy has helped medical professionals in more than 44 countries achieve their goals of continuous professional growth. Its lifetime partnerships with medical professionals throughout Europe, the USA, Africa, Central and South America, Australia and Asia provide crucial knowledge to keep them on the leading edge of their profession.



For more information:

Call:

1-800-258-1946, Ext. 5223

or visit our website:

www.aesculapusa.com/aesculap-academy.com

Surgical Asset Management



Think Solutions. Think Aesculap.

It's our commitment to share the expertise we've gained, through decades of experience, with each and every customer looking for a solution. It is this commitment to sharing our knowledge and our tradition of excellence that has made us the partner of choice for many top hospitals throughout the world. Let Aesculap partner with you and aid in the design of an individual solution that will help optimize the efficiency of your SPD and OR.

Think Solutions. Think Aesculap.

Consulting Solutions

Technical Solutions

IT Solutions

Supply Solutions

Consulting Solutions

QuickScan[®] Analysis

A baseline assessment of surgical instrumentation and reprocessing practices in Central Service Department (CSD) and the Operating Room.

- Offering you strategic recommendations for long-term process improvements
- Hands-on best practices and benchmark data provide immediate impact and real results
- Reduced weight of instrument trays and better ergonomics result in less work for the SPD staff
- Inventory can be reallocated to reduce your need to purchase additional back-up supplies

Process Optimization

Continuing the improvement of quality, efficiency and value of Surgical Asset Management within the CSD and the OR.

- Consultants will assist with the implementation of outlined recommendations to help you achieve your goals and apply proper surgical asset management practices. Service can include assistance with water quality improvements, development of CSD educational programs and training, establishing repeatable and transparent processes for quality reporting, and more.

Asset Analysis

A qualitative and quantitative examination of your surgical instrument fleet.

- Analyze and document the quality of your current instrument inventory
- Supply recommendations for care and handling that will prolong your instrument life
- Analyze instrument inventory levels to determine if sufficient to meet hospital procedure volume

Asset Optimization

The process to standardize, optimize and containerize surgical sets and contents.

- Having only the instruments you most commonly use in a set to minimize reprocessing costs

Ongoing Training & Partnership

Formulating a long term, strategic solutions supplier to help achieve your clinical and financial goals.

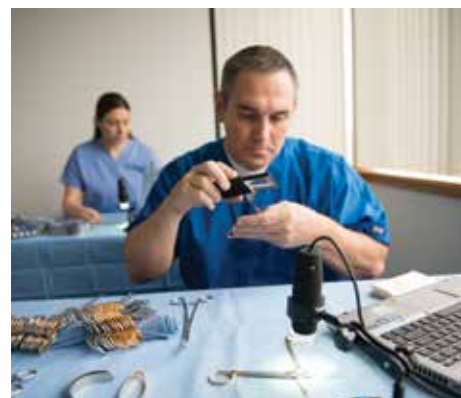

For more information:

Contact your Aesculap Sales Representative for more information on how these consulting solutions can be implemented in your facility.

Repairs by Aesculap



Technical Solutions

We Know Instruments

As a premiere manufacturer of performance quality instruments for 150 years, Aesculap has the knowledge, expertise and craftsmanship to repair and maintain your surgical instruments with the same strict quality standards and components as those used in original instrument manufacturing. Aesculap is the only repair provider that combines the highest levels of service and response with the unmatched quality standards of an original manufacturer.

Your surgical instruments comprise a significant proportion of your medical facility's total assets. Aesculap understands the value of this investment. Our skilled craftsmen and trained instrument makers will refurbish your surgical instruments to "like new" condition, quickly and conveniently, using the same precision equipment in our repair facility that is used to manufacture these instruments in Tuttlingen, Germany. Factory spare parts give Aesculap the ability to repair your instrumentation with quality materials that match the original, thus protecting your instruments from contamination and corrosion. This protection can further reduce repairs, replacement costs and down time.

Full Service Repairs

- General instruments
- Endoscopic instruments
- Powered instruments
- Rigid and Flexible Endoscopes
- Micro-Neuro instruments
- Cardiovascular instruments
- Visual systems
- SterilContainer™ systems
- and more



**For repairs and service,
please contact:**

Aesculap Technical Service - ATS

St. Louis Distribution &
Technical Service Center
615 Lambert Pointe Drive
Hazelwood, MO 63042-2609
800-214-3392

IT & Supply Solutions



Direct Part Marketing

Tracking your supplies down to the instrument level

- Laser etched, machine-readable data matrix contains the Global Trade Item Number (GTIN) and other required information for UDI compliance
- Traceability of instruments down to the individual patient
- Machine readable technology saves your technicians time
- Tracking of specialty one-of-a-kind or expensive instruments reduces loss
- All Aesculap instruments, size permitting, come with a data matrix label at no additional cost

Procedural Cost Management Systems (PCMS)

Aesculap provides high quality surgical products and services to a facility on a fee per procedure basis.

- Provide new technology to your surgeons quickly and without capital investment
- Not only do you receive new instruments, but also the services that go towards maintaining the instruments for the life of your contract
- Optional on-site technician will process and assemble the instrument sets
- Ensures sets are ready every time, removing the worry of instrument readiness

Our sales representatives work with each surgical and processing team to analyze existing sets, procedure volumes, and costs. *PCMS* guarantees optimal results with high quality, professionally maintained instruments.



For more information:

Please contact your Aesculap representative for further details or call Customer Service at **800-282-9000**

General Instrument Inspection Guidelines



Surgical Instruments

Visually inspect the instrument surface. The surface should be clean, smooth and free from staining, crevices, rough spots and grinding marks (which could provide an opportunity for corrosion and also harbor bacteria). Carefully examine the tips of the instrument, blades, handles, box locks, alignment and working mechanism of the instrument.

Tungsten Carbide Instruments

Tungsten carbide inserts should not have any gaps or holes in the solder that could collect surgical debris that might lead to corrosion and pitting. The insert seam should be almost invisible.

Ratcheted Instruments

Ratchets should be beveled so there are no sharp edges. They should be smooth and clean. The ratchets should lock and unlock easily without excessive force.

***Please visit www.aesculapUSA.com for specific information on inspecting, cleaning and Instructions for Use.**

Scissors

- To test the sharpness and proper alignment of scissors, make a cut using the distal two thirds of scissor blades. The scissors should cut to the tip and the cut should be smooth with no drag.
- Open the scissors. Holding onto the bottom ring of the scissors, drop the top ring. The distal tips of the blades should remain 1/2 to 1/3 open. If the blade closes completely, the scissors are too loose. If it closes less than halfway, the scissors are too tight.

Needle Holders

- The jaws should touch when closed and holding a needle. If the ratchets do not engage, excessive pressure will be placed on the jaws when grasping a suture needle. This condition could lead to metal fatigue and stress crack failure.
- Hold the needle holder up to the light. You should not see light through the serrations, with the jaws closed and touching.
- Close the jaws on a piece of tin foil. You should see an even "mesh" pattern, with no gaps or pinholes.
- The needle holder should have easy, even movement at every position.

Hemostats and Cardiovascular Clamps

- Close a standard hemostat clamp. The jaws should touch on the first ratchet; in addition, the jaws should close tighter as the clamp is being closed on the last ratchet.

- Vascular clamps need more ratchets than other instruments in order to allow the surgeon precise controlled occlusion. A properly adjusted clamp should have the distal tips touching when the instrument is closed to the middle ratchet.
- The instrument should have a flexible feel to it when being locked and unlocked. Hold onto the top ring handle and drop the bottom ring. The handle should not swing freely, but move with minimal effort.
- It is important to check the box lock and verify that there is no "play" in the box lock. This is especially critical on long CV clamps because a little movement in the box lock becomes significantly more movement at the tip of the jaw. This could lead to improper meshing of the teeth and potential tearing of delicate vessels because of the movement in the alignment of the jaws.

Rongeurs and Kerrisons

- A properly sharpened Kerrison should cut a business card cleanly or leave an even indentation. Due to the variety of business cards and the materials used in making them, the thickness may vary. When using a thick business card, a clean cut may not be achieved and an even indentation will indicate a sharp instrument.
- Squeeze the Kerrison handle closed. The action should be smooth with no grinding or catching. When closed, the moving shaft should touch the foot plate, not traveling too far, causing stress to the foot plate.

- The Kerrison handle should spring back quickly when released. If the instrument does not spring back, check to make sure the instrument has been properly cleaned and lubricated.
- Hold the Kerrison up to the light in the closed position. The jaws of the instrument should meet precisely to assure proper function (no light should shine through the jaws).
- Intervertebral disc rongeurs should grasp a hair firmly and cut it cleanly. The jaws should meet precisely and should always be sharpened from the inside of the jaws (not ground or filed from outside) to maintain proper cutting alignment.
- Double action bone rongeurs should be free of play in the shanks and jaws.

Curettes

- The cup profile should be flat across the top without nicks or gouges.
- A properly sharpened curette, when scraped against a piece of plastic, should plane off "ribbons" of plastic.
- The cup should always be sharpened from the inside to the outside edge.

Care and Maintenance of Surgical Instruments



Treatment of New Instruments

Brand new instruments must be cleaned before the first sterilization or use.

Protective caps and protective films must be removed completely, especially for chisels, raspatories or microsurgical instruments.

Care/Testing

- Lubricate movable parts (e.g. joints and ends) slightly with special sterilization-capable, vapor-permeable lubricant (e.g. Aesculap STERILIT Spray JG 600 or Lubricant JG 598).
- After each cleaning and disinfection process, check the instrument to make sure it is clean, it functions properly and it has not suffered any damage, (e.g. bent, stained, broken, fractured or worn parts).
- Do not use defective or nonfunctioning instruments. Evaluation and repair can be performed by Aesculap Technical Service.
- Discard nonrepairable instruments.
- Sharpen (if appropriate) and maintain instruments on a regular schedule.



Storage

- Place instruments with fine working ends and/or microsurgery instruments in a suitable storage rack.

Recommended Products:



Sterilit® JG600

Aesculap oil spray, DBP, in spray-can (non-CFC propellant), for lubricating instruments prior to sterilization. Physiologically safe according to DAB and § 31 LMBG.



Sterilit® JG598

Aesculap Instrument Lubricant, DBP, for lubricating ends, locks etc. prior to sterilization. Physiologically safe according to DAB and §31 LMBG.

Conversions

Fractional Inches	Millimeters
1/16	1.588
1/8	3.175
3/16	4.736
1/4	6.350
5/16	7.938
3/8	9.525
7/16	11.113
1/2	12.700
9/16	14.288
5/8	15.875
11/16	17.463
3/4	19.050
13/16	20.638
7/8	22.225
15/16	23.813
1	25.400

Conversions:

Inches to Centimeters

$$\text{cm} = \text{in} \times 2.54$$

Centimeters to Inches

$$\text{in} = \text{cm} \times 0.3937$$

Millimeters to Inches

$$\text{in} = \text{mm} \times 0.03937$$

Instrument Angles

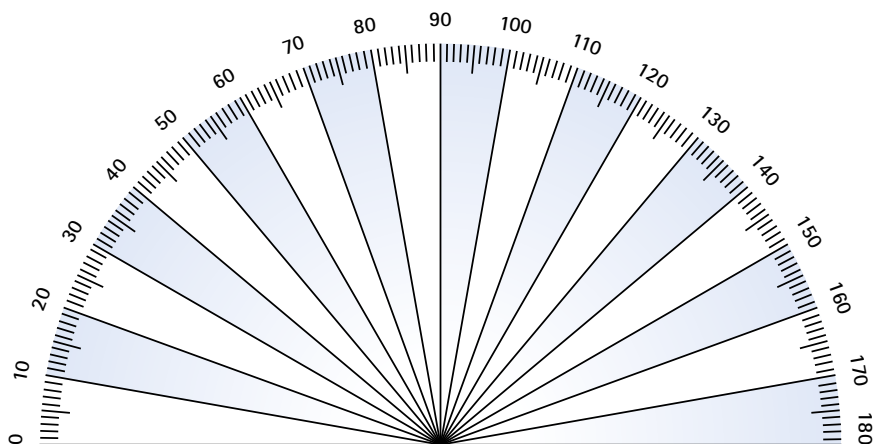

Conversion Scales and Gauges

Conversion Scale		
To Convert From	To	Multiply
Ounces (AVDP.)	Grams	28.349523
Ounces (APOTH.)	Grams	31.103486
Grains	Grams	0.06479891
Pounds (AVDP.)	Kilograms	0.45359237
Inches	Centimeters	2.54
Feet	Meters	0.3048
Yards	Meters	0.9144
Ounces (U.S. Fluid)	Cubic Centimeters	29.573730
Ounces (British Fluid)	Cubic Centimeters	28.41305
Quarts (U.S. Fluid)	Liters	0.9463264
Cubic Inches	Cubic Centimeters	16.387064
Grams	Grains	15.432358
Grams	Ounces (AVDP.)	0.35273962
Grams	Ounces (APOTH.)	0.32150737
Kilograms	Pounds (AVDP.)	2.2046226
Millimeters	Inches	0.039370079
Centimeters	Inches	0.39370079
Meters	Feet	3.2808399
Cubic Centimeters	Cubic Inches	0.61023744
Cubic Centimeters (Fluid)	Ounces U.S. Fluid)	0.33814023
Liters	Quarts (U.S. Fluid)	1.056718

Fahrenheit and Centigrade Scales

F.	C.
500°	260°
400	205
392	200
383	195
374	190
356	180
347	175
338	170
329	165
320	160
311	155
302	150
284	140
275	135
266	130
248	120
239	115
230	110
212	100
203	95
194	90
176	80
167	75
140	60
122	50
113	45
105	40.56
104	40
100	37.8
98.5	36.9
95	35
86	30
77	25
68	20
50	10
41	5
32	0
23	-5
14	-10
+5	-15
-4	-20
-13	-25
-22	-30
-40	-40
-76	-60
1° F. = 5/9° C.	
1.8° F. = 1° C.	
3.6° F. = 2° C.	
4.5° F. = 2.5° C.	
5.4° F. = 3° C.	

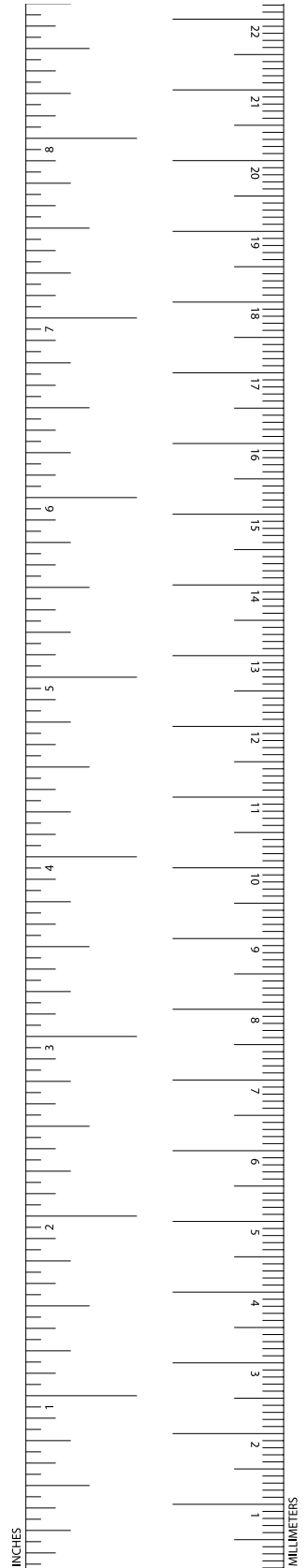

Standard French (Charrière) Gauge

Standard French:

The standard French or Charrière is used to measure diameters of all Bougies, Sounds, Catheters, Suction Tubes and Uterine Dilators.

Example:

12 Fr indicates a diameter of 4 mm

21 Fr indicates a diameter of 7 mm

<i>French</i>	3	4	5	6	7	8	9	10	11	12	13	14	15
<i>American</i>				4			6			8			10
	○	○	○	○	○	○	○	○	○	○	○	○	○
	1 mm			2 mm			3 mm			4 mm		5 mm	

<i>French</i>	16	17	18	19	20	22	24	26	28	30	32	34
<i>American</i>			12				16			20		
	○	○	○	○	○	○	○	○	○	○	○	○
			6 mm				8 mm			10 mm		

<i>French</i>	36	38	40	42	44	45
<i>American</i>	24					30
	○	○	○	○	○	○
	12 mm					15 mm

* Chart is actual size

Instrument Measurements

Illustration 1:

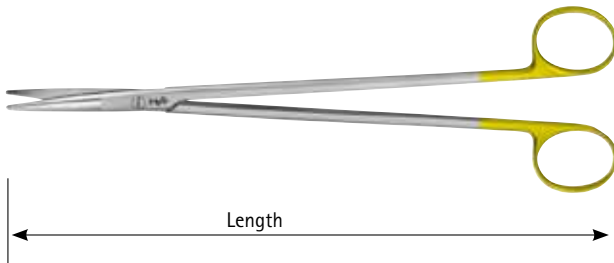

Illustration 2:

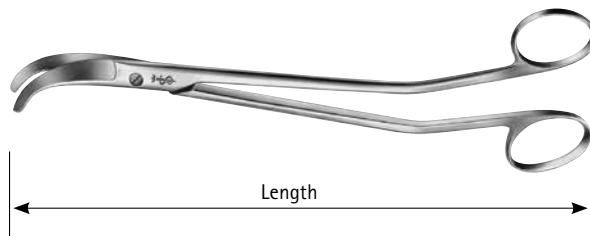

Illustration 3:

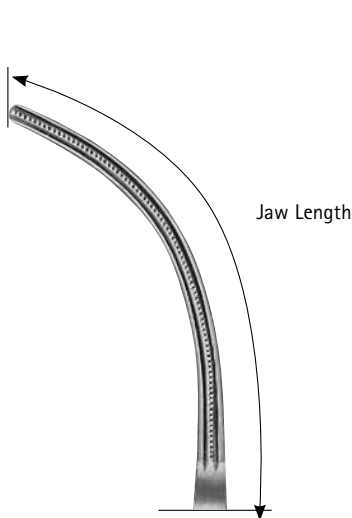
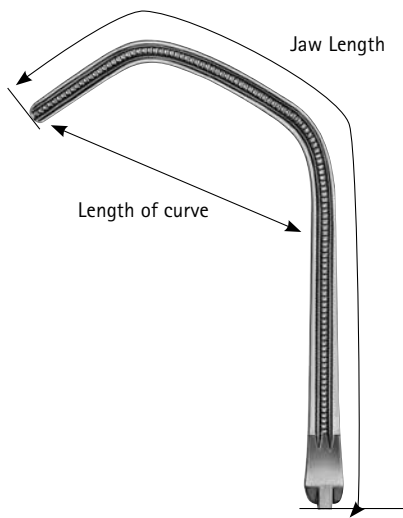

Illustration 4:



Instrument Length:

To measure the total length of an instrument, start at the bottom of the instrument and measure to the farthest tip in a straight line (*Illustration 1*).

For curved and angled instruments, the distance of a perpendicular line drawn from the bottom of the instrument to the farthest point will determine the overall instrument length (*Illustration 2*).

Jaw:

The jaw length of a clamp is measured from the beginning of the jaw to the bottom of the serrations (*Illustration 3*). For partial occlusion clamps, see *Illustration 4*.

Tip and jaw illustrations are approximate unless otherwise noted.

Table of Contents

Page Number

GENERAL SURGERY		General Surgery	1 - 326
CARDIO VASCULAR		Cardiovascular	327 - 534
ENT EAR		ENT - EAR	535 - 594
ENT NASAL		ENT - NASAL	595 - 704
ENT ORAL		ENT - ORAL	705 - 746
PLASTIC SURGERY		Plastic Surgery	747 - 810
EYE		EYE	811 - 878

Table of Contents

Page Number

Orthopedics/Spine	879 - 1066		ORTHO SPINE
Neurosurgery	1067 - 1166		NEURO SURGERY
Electrosurgery	1167 - 1200		ELECTRO SURGERY
Obstetrics/Gynecology	1201 - 1296		OB/GYN
Urology	1297 - 1322		UROLOGY
Numerical Index	1323 - 1364		0 - 9
Alphabetical Index	1365 - 1394		A - Z

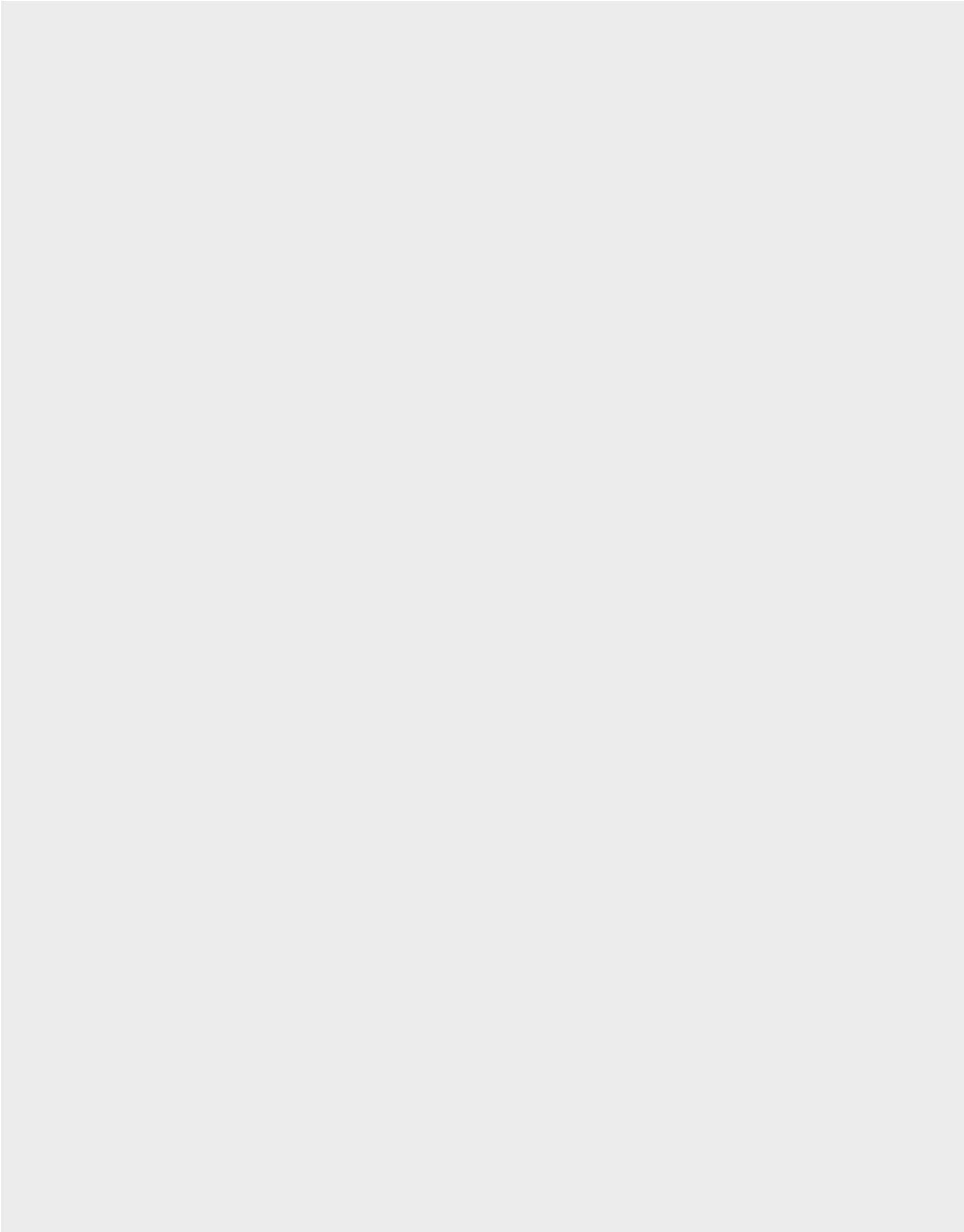
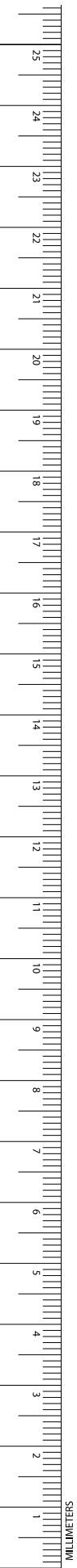



General Surgery

Scissors	2 - 52
Needle Holders and Cases	53 - 76
Ligature Needles	77 - 78
Forceps and Clamps	79 - 189
Skin Hooks	190 - 192
Retractors	193 - 254
Universal Ring Retractor System	255 - 271
Self Retaining Retractors	272 - 283
Rectal Specula Instruments	284 - 291
Probes, Dilators and Scoops	292 - 299
Scalpel Blades and Handles	300 - 307
Amputation and Autopsy Instruments	308 - 310
Suction Instruments	311 - 322
Rulers, Calipers and Accessories	323 - 324
Metal Bowls and Cups	325

General Surgery

Scissors

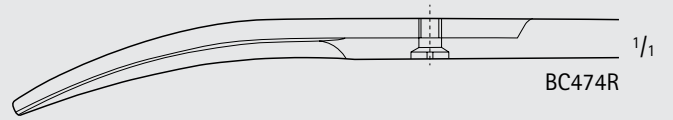
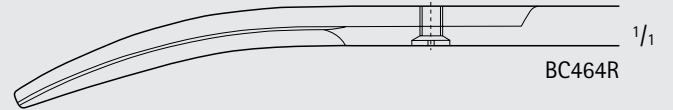
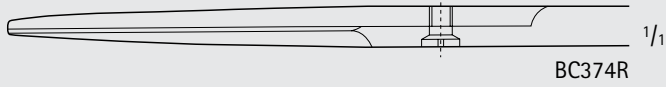

DEAVER Suture Scissors

Catalog Number	Tip	Blade	Length (in.)
BC374R	S/B	STR	5 3/4
BC474R	S/B	CVD	5 3/4
BC464R	B/B	CVD	5 3/4

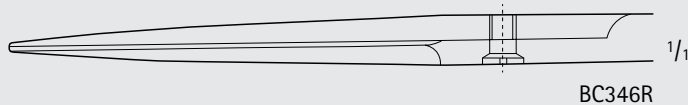
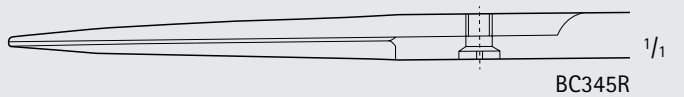
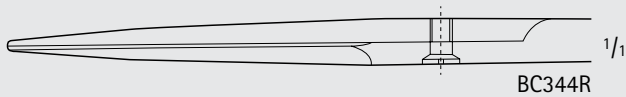
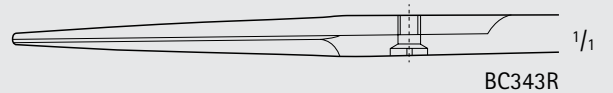
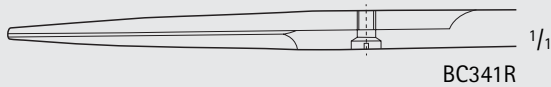
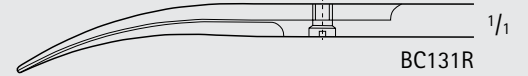
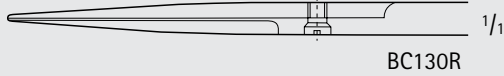

Suture Scissors

Catalog Number	Tip	Blade	Length (in.)
BC130R	S/S	STR	4 3/4
BC341R	S/S	STR	4 1/2
BC343R	S/S	STR	5 1/8
BC344R	S/S	STR	5 3/4
BC345R	S/S	STR	6
BC346R	S/S	STR	6 1/2
BC131R	S/S	CVD	4 3/4



BC441R-BC445R

Suture Scissors

Catalog Number	Tip	Blade	Length (in.)
BC441R	S/S	CVD	4 1/2
BC443R	S/S	CVD	5 1/8
BC444R	S/S	CVD	5 3/4
BC445R	S/S	CVD	6

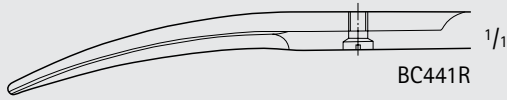

BC441R

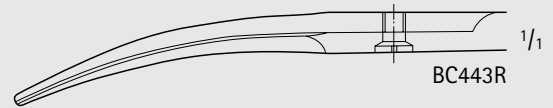

BC443R

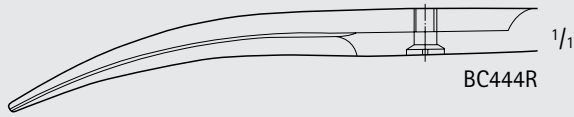

BC444R

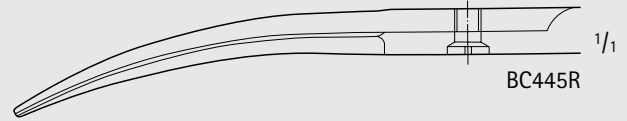

BC445R



BC303R-BC304R

Suture Scissors

Catalog Number	Tip	Blade	Length (in.)
BC303R	S/B	DEL, STR	5 1/8
BC304R	S/B	DEL, STR	5 3/4

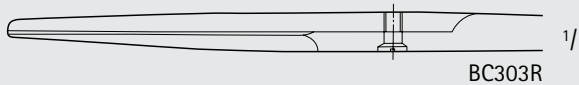

BC303R

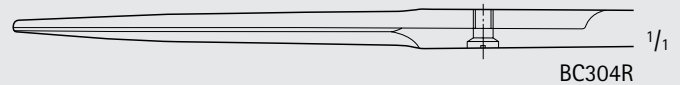

BC304R



BC496R

Scissors

Catalog Number	Tip	Blade	Length (in.)
BC496R	S/B	STR/1-SERR	5 1/8

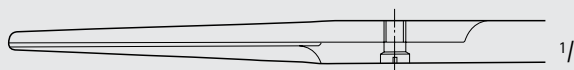

BC496R



General Surgery

Scissors

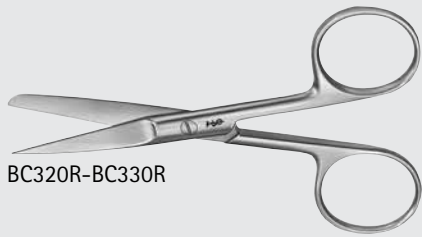

BC320R-BC330R

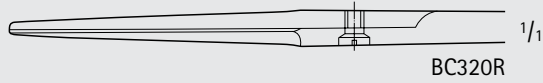

BC320R

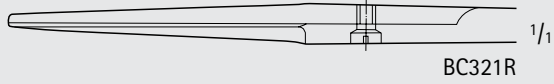

BC321R

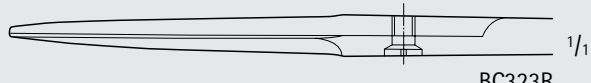

BC323R

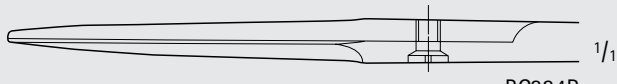

BC324R



BC325R

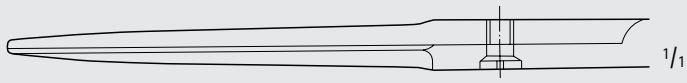

BC326R

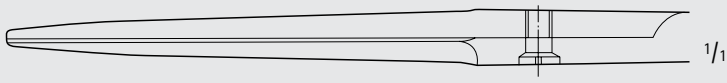

BC327R

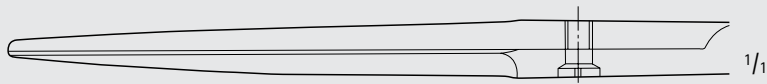

BC328R

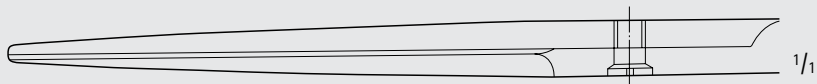

BC330R

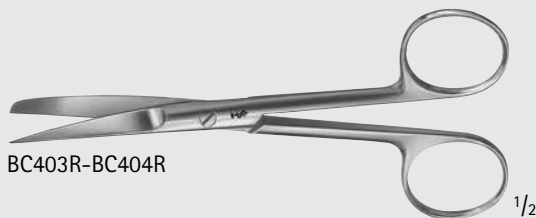

BC403R-BC404R

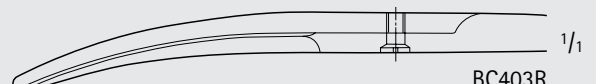

BC403R

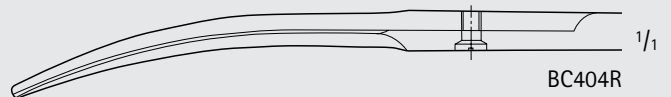

BC404R

Suture Scissors

Catalog Number	Tip	Blade	Length (in.)
BC320R	S/B	STR	4 1/8
BC321R	S/B	STR	4 1/2
BC323R	S/B	STR	5 1/8
BC324R	S/B	STR	5 3/4
BC325R	S/B	STR	6
BC326R	S/B	STR	6 1/2
BC327R	S/B	STR	6 7/8
BC328R	S/B	STR	7 1/4
BC330R	S/B	STR	7 7/8
BC403R	S/B	CVD	5 1/8
BC404R	S/B	CVD	5 3/4



BC421R-BC428R

Suture Scissors

Catalog Number	Tip	Blade	Length (in.)
BC421R	S/B	CVD	4 1/2
BC423R	S/B	CVD	5 1/8
BC424R	S/B	CVD	5 3/4
BC425R	S/B	CVD	6
BC426R	S/B	CVD	6 1/2
BC428R	S/B	CVD	7 1/4

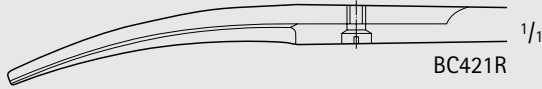

BC421R

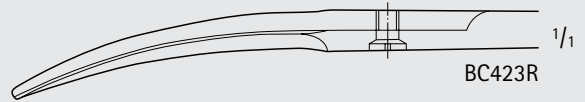

BC423R



BC424R

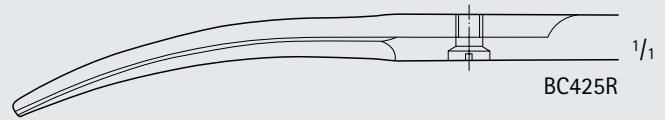

BC425R



BC426R

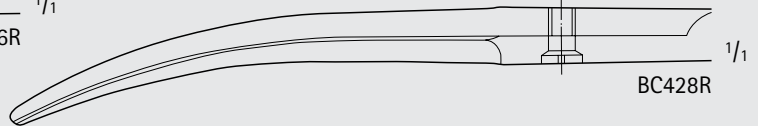

BC428R



BC135R

Suture Scissors

Catalog Number	Tip	Blade	Length (in.)
BC135R	B/B	CVD, DEL	4 3/4

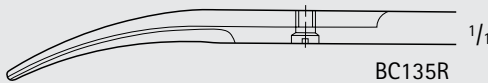

BC135R



INCHES

General Surgery

Scissors



BC313R-BC317R

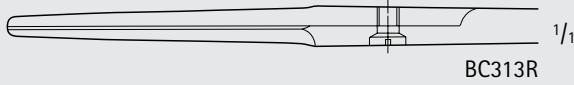

BC313R

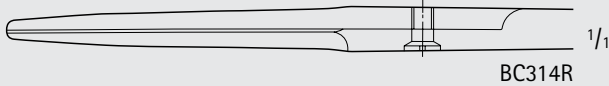

BC314R

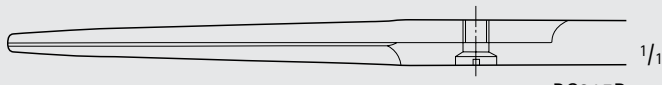

BC315R

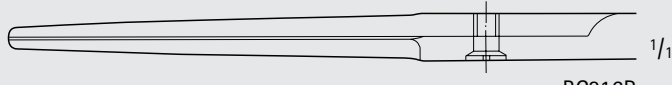

BC316R

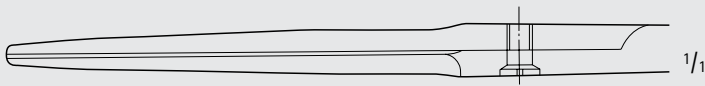

BC317R



BC411R-BC417R

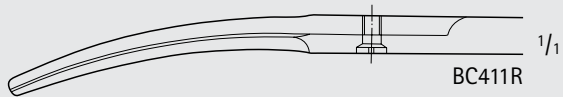

BC411R

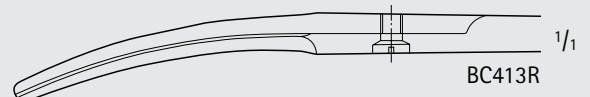

BC413R

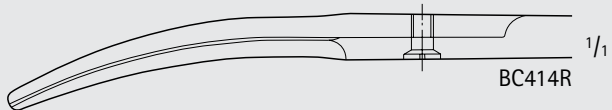

BC414R

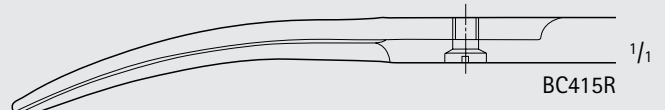

BC415R

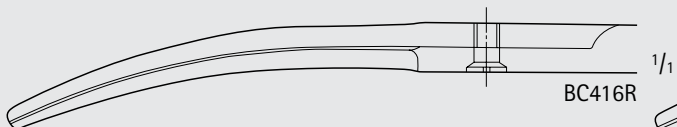

BC416R

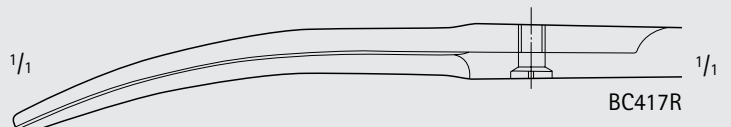

BC417R

COOPER Suture Scissors

Catalog Number	Tip	Blade	Length (in.)
BC313R	B/B	STR	5 1/8
BC314R	B/B	STR	5 3/4
BC315R	B/B	STR	6
BC316R	B/B	STR	6 1/2
BC317R	B/B	STR	6 7/8
BC411R	B/B	CVD	4 1/2
BC413R	B/B	CVD	5 1/8
BC414R	B/B	CVD	5 3/4
BC415R	B/B	CVD	6
BC416R	B/B	CVD	6 1/2
BC417R	B/B	CVD	6 7/8



LITTAUER Ligature Scissors

Catalog Number	Tip	Blade	Length (in.)
BC803R	B/1-NOTCH	STR	5 1/4

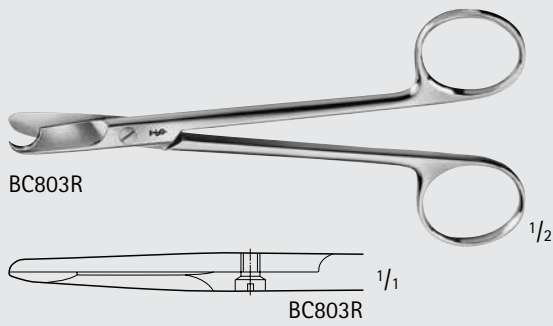

NORTHBENT Ligature Scissors

Catalog Number	Tip	Blade	Length (in.)
BC805R	B/1-NOTCH	LAT-CVD	4 3/4

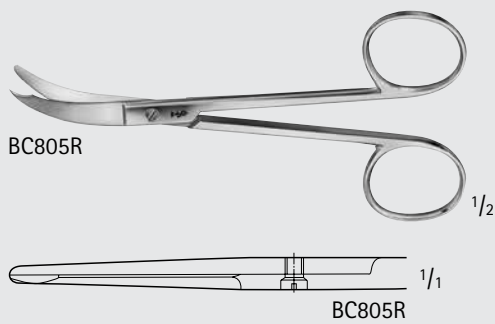

SPENCER Suture Scissors

Catalog Number	Tip	Blade	Length (in.)
BC801R	B/1-NOTCH	STR	3 1/2
BC802R	B/1-NOTCH	STR	4 1/2

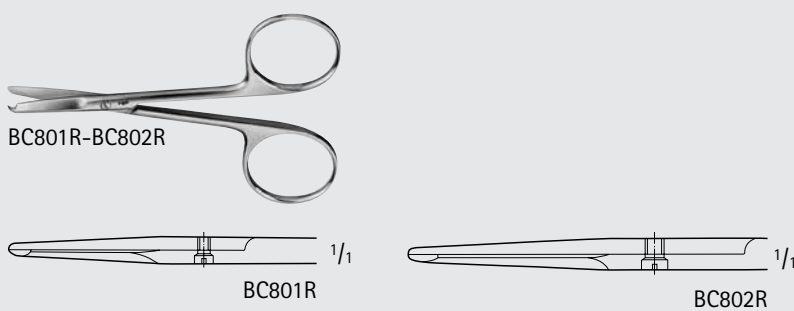

KNOWLES Bandage Scissors

Catalog Number	Tip	Blade	Length (in.)
BC846R	1-PROBE-POINT	STR	5 3/4
BC847R	1-PROBE-POINT	LAT-ANG	5 1/2

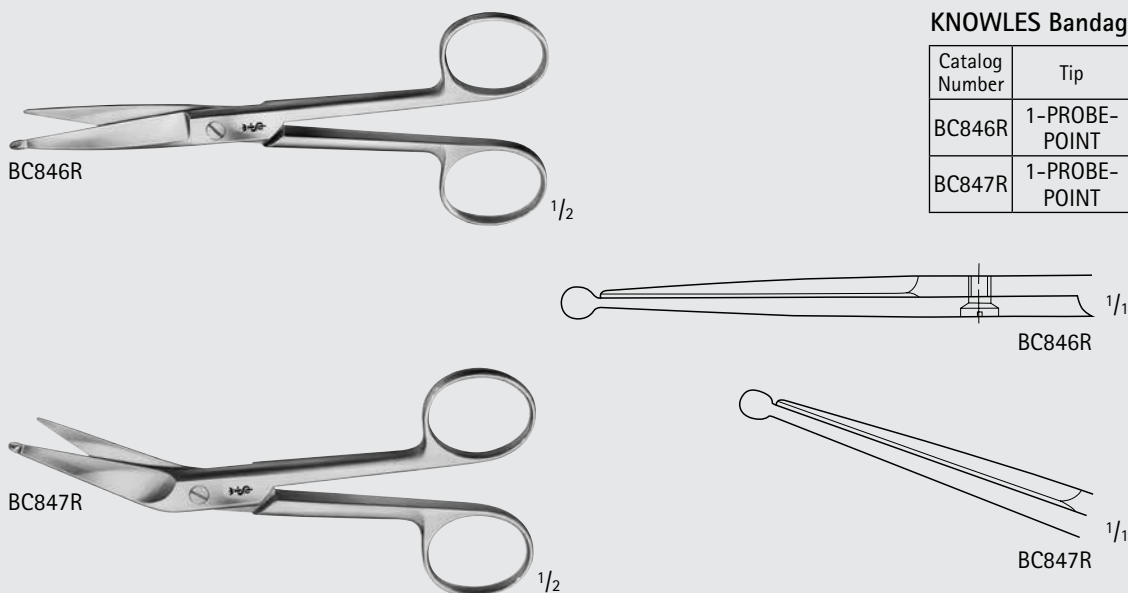

General Surgery

Scissors



BC848R-BC863R

LISTER Bandage Scissors

Catalog Number	Blade	Length (in.)
BC848R	LONG	6 1/8
BC849R	LONG	7
BC860R	STANDARD	4 1/2
BC861R	STANDARD	5 1/2
BC862R	STANDARD	7
BC863R	STANDARD	7 7/8

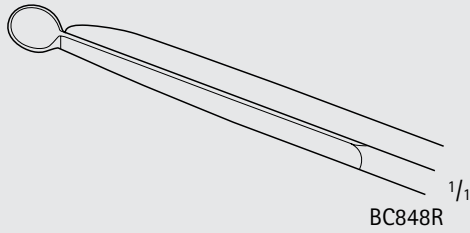

BC848R

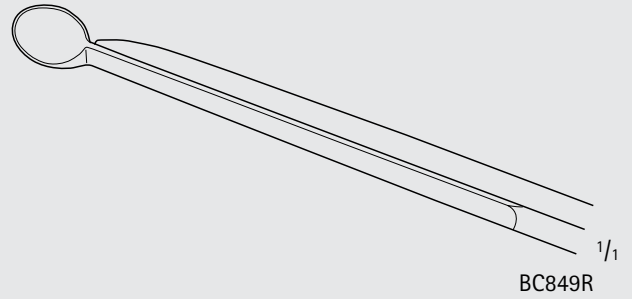

BC849R

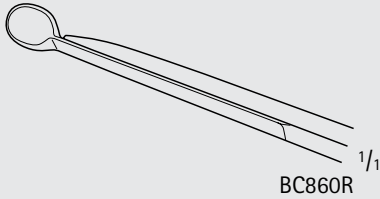

BC860R

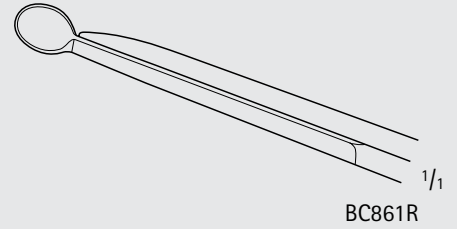

BC861R

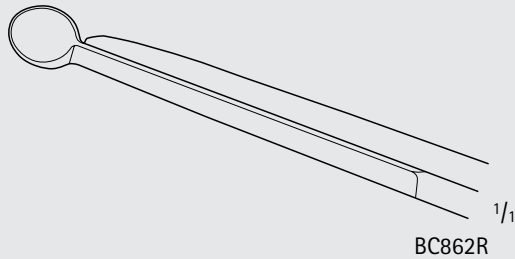

BC862R

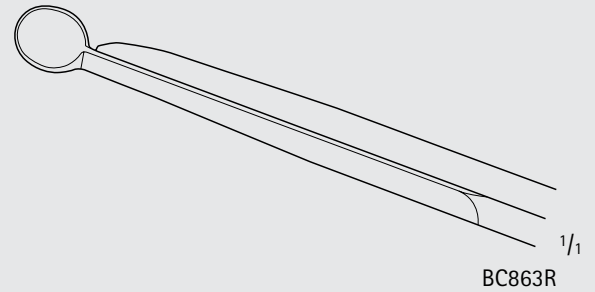

BC863R

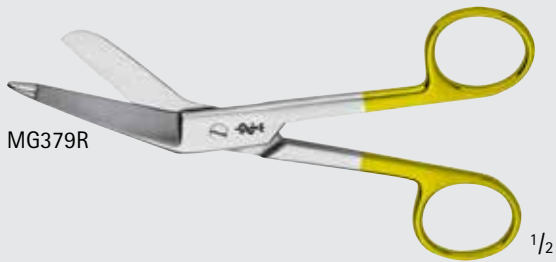

MG379R

LISTER Bandage Scissors, Gold Handle

Catalog Number	Length (in.)
MG379R	5 1/2

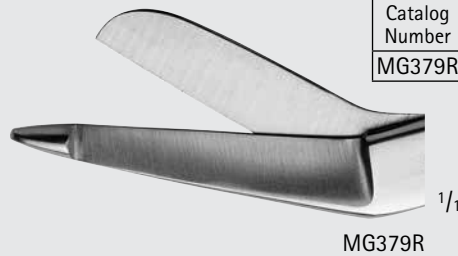

MG379R

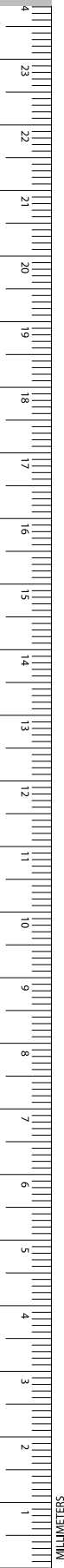



MB223

LISTER Bandage Scissors, W/ One Large Ring

Catalog Number	Length (in.)
MB223	8



MB223



BC876R, MB146R

LISTER Bandage Scissors, Serrated

Catalog Number	Length (in.)
MB146R	3 1/2
BC876R	6 1/4

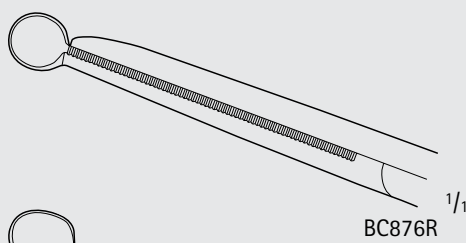

BC876R

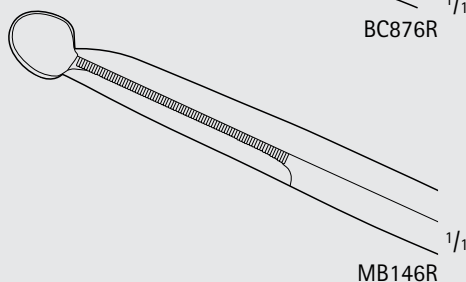

MB146R



General Surgery

Scissors

GENERAL SURGERY

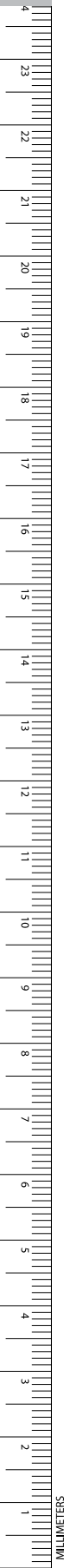

BC890R

1/2

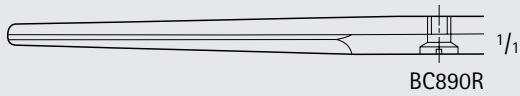

BC890R

1/1

Nurse's Bandage Scissors

Catalog Number	Tip	Blade	Handle Color	Length (in.)
BC890R	B/B	STR	RED	5 3/4



BC885R-BC979R

1/2

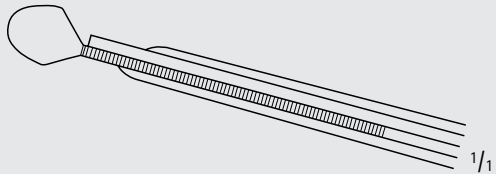

BC885R-BC979R

1/1

LISTER Universal Bandage Scissors, Serrated

Catalog Number	Handle Color	Length (in.)
BC885R	BLACK	5 3/4
BC970R	RED	5 3/4
BC971R	BLUE	5 3/4
BC973R	YELLOW	5 3/4
BC975R	ORANGE	5 3/4
BC977R	PINK	5 3/4
BC978R	LIGHT GREEN	5 3/4
BC979R	VIOLET	5 3/4



BC881R-BC989R

1/2

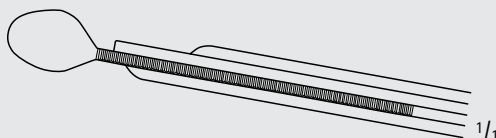

BC881R-BC989R

1/1

Universal Bandage Scissors, W/ One Large Ring, Serrated

Catalog Number	Handle Color	Length (in.)
BC881R	BLACK	7
BC980R	RED	7
BC981R	BLUE	7
BC983R	YELLOW	7
BC985R	ORANGE	7
BC987R	PINK	7
BC988R	LIGHT GREEN	7
BC989R	VIOLET	7

STILLE Dissecting Scissors, Round Blades

Catalog Number	Tip	Blade	Length (in.)
BC580R	B/B	STR	6
BC581R	B/B	CVD	6



1/2

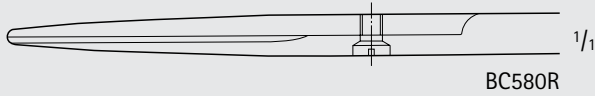

1/1

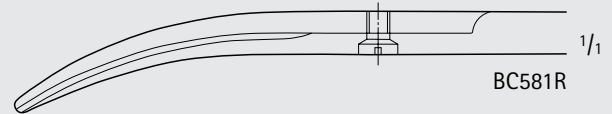

1/1

MAYO Dissecting Scissors, Round Blade

Catalog Number	Tip	Blade	Length (in.)
BC584R	B/B	STR	6 1/2
BC585R	B/B	STR	7 7/8
BC587R	B/B	CVD	6 1/2
BC588R	B/B	CVD	7 7/8
BC589R	B/B	CVD	8 1/4

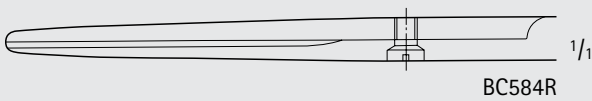

1/1

BC584R

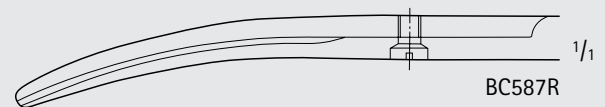

1/1

BC587R

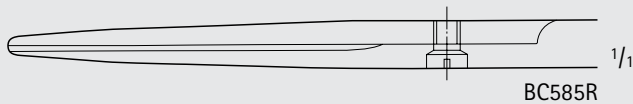

1/1

BC585R

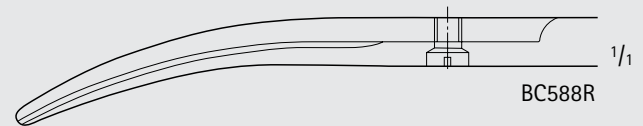

1/1

BC588R

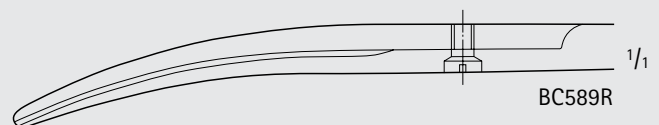

1/1

BC589R



INCHES

General Surgery

Scissors



BC560R-BC561R $\frac{1}{3}$

BC560R $\frac{1}{1}$

BC561R $\frac{1}{1}$

Catalog Number	Tip	Blade	Length (in.)
BC560R	B/B	STR	9
BC561R	B/B	CVD	9

BC567R-BC568R $\frac{1}{3}$

BC568R $\frac{1}{1}$

BC567R $\frac{1}{1}$

Catalog Number	Tip	Blade	Length (in.)
BC568R	B/B	STR	11
BC567R	B/B	CVD	11

MB148R $\frac{1}{3}$

MB148R $\frac{1}{1}$

Catalog Number	Tip	Blade	Length (in.)
MB148R	B/B	HEAVY	14



BC544R-BC557R

MAYO Dissecting Scissors, Beveled Blade

Catalog Number	Tip	Blade	Length (in.)
BC544R	B/B	STR	5 1/2
BC545R	B/B	STR	6 1/8
BC547R	B/B	STR	6 3/4
BC562R	B/B	STR	7 1/2
BC564R	B/B	STR	8 1/2
BC554R	B/B	CVD	5 1/2
BC555R	B/B	CVD	6 1/8
BC557R	B/B	CVD	6 3/4
BC563R	B/B	CVD	7 1/2
BC565R	B/B	CVD	8 1/2

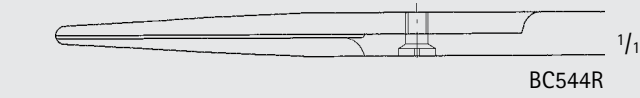

BC544R

1/1

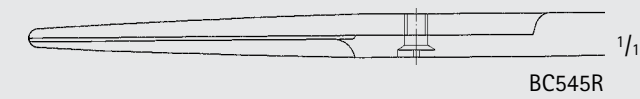

BC545R

1/1

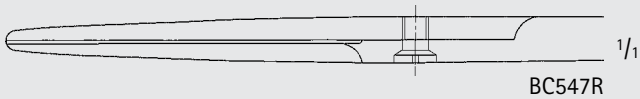

BC547R

1/1

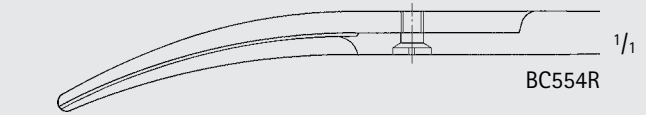

BC554R

1/1

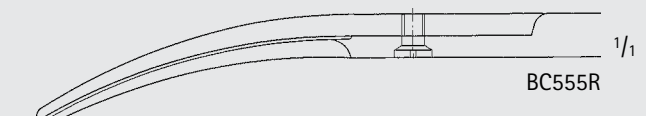

BC555R

1/1

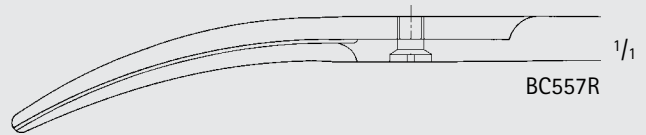

BC557R

1/1



BC562R-BC565R

1/2

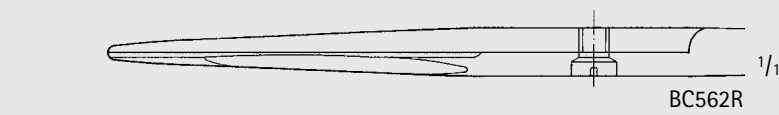

BC562R

1/1

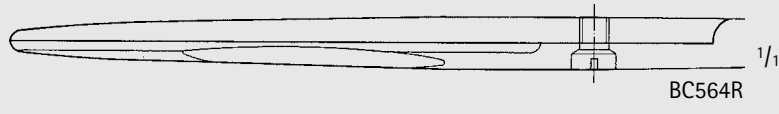

BC564R

1/1

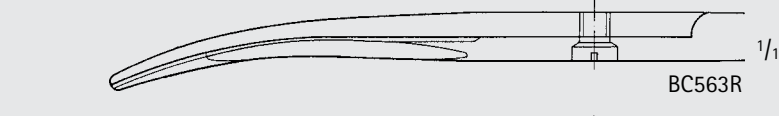

BC563R

1/1

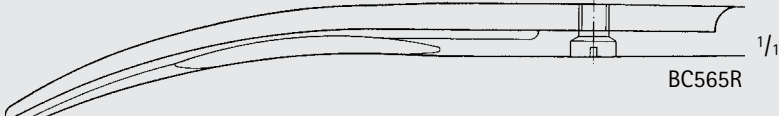

BC565R

1/1



INCHES

General Surgery

Scissors



MAYO Operating Scissors

Catalog Number	Tip	Blade	Length (in.)
BC466R	S/S	STR	5 1/2
BC467R	S/S	CVD	5 1/2

BC466R-BC467R 1/2

BC466R 1/1

BC467R 1/1

MAYO Dissecting Scissors, Delicate

Catalog Number	Tip	Blade	Length (in.)
BC594R	B/B	STR	5 1/2

BC594R 1/2

BC594R 1/1

NEW'S Suture Scissors

Catalog Number	Tip	Blade	Length (in.)
BC804R	B/B	ANG	5 1/2

BC804R 1/2

BC804R 1/1



Suture Scissors

Catalog Number	Tip	Blade	Length (in.)
BC806R	B/B	STR	4 1/2

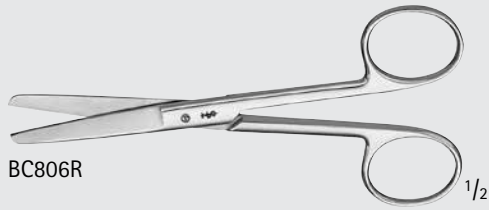

BC806R

1/2

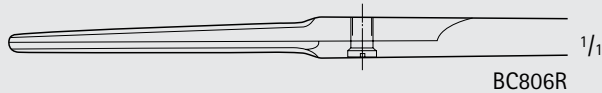

BC806R

1/1

LEXER Dissecting Scissors, Delicate

Catalog Number	Tip	Blade	Length (in.)
BC590R	B/B	STR	6 1/2
BC591R	B/B	CVD	6 1/2

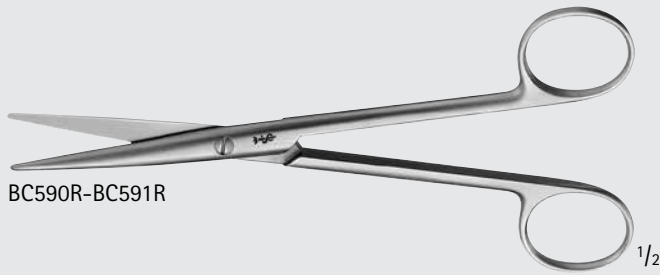

BC590R-BC591R

1/2

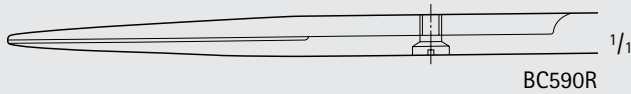

BC590R

1/1

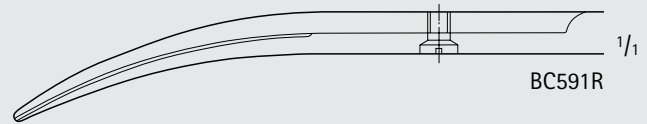

BC591R

1/1

MAYO-LEXER Dissecting Scissors

Catalog Number	Tip	Blade	Length (in.)
BC592R	B/B	CVD	6 1/2

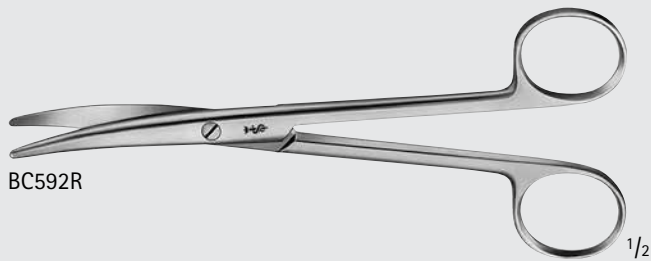

BC592R

1/2

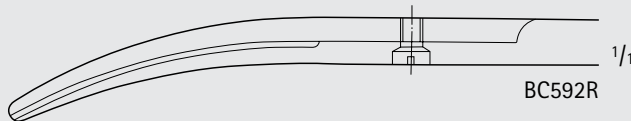

BC592R

1/1

MAYO-SIMS Dissecting Scissors

Catalog Number	Tip	Blade	Length (in.)
MB149R	B/B	STR	7 3/4

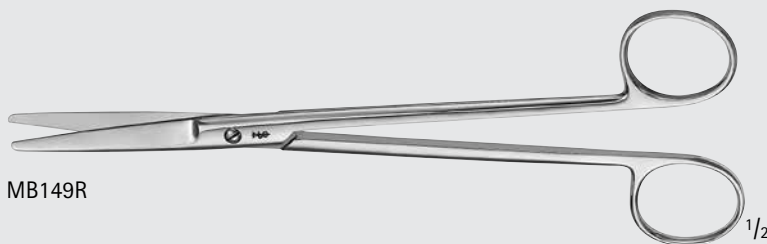

MB149R

1/2



MB149R

1/1

General Surgery

Scissors

GENERAL SURGERY



BC566R-BC569R 1/2

BC566R 1/1 BC569R 1/1

Catalog Number	Tip	Blade	Length (in.)
BC566R	B/B	STR	6 3/4
BC569R	B/B	CVD	6 3/4

BC576R-BC579R

BC576R 1/1 BC577R 1/1

BC578R 1/1 BC579R 1/1

Catalog Number	Tip	Blade	Length (in.)
BC576R	B/B	STR	5 1/2
BC578R	B/B	STR	6 1/2
BC577R	B/B	CVD	5 1/2
BC579R	B/B	CVD	6 1/2

BC570R-BC575R

BC570R 1/1 BC573R 1/1

BC572R 1/1 BC575R 1/1

Catalog Number	Tip	Blade	Length (in.)
BC570R	B/B	STR	5 1/2
BC572R	B/B	STR	6 3/4
BC573R	B/B	CVD	5 1/2
BC575R	B/B	CVD	6 3/4



TOENNIS Dissecting Scissors

Catalog Number	Tip	Blade	Length (in.)
BC633R	B/B	X-DEL, STR	7
BC634R	B/B	DEL, STR	7
BC635R	B/B	DEL, CVD	7

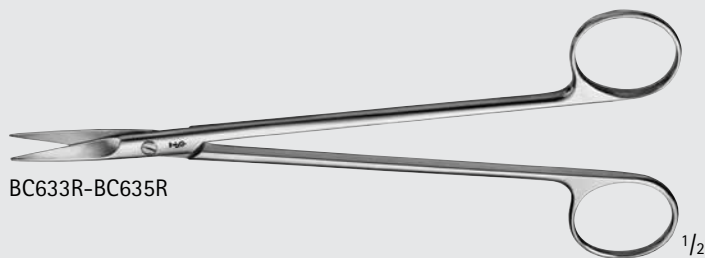

BC633R-BC635R

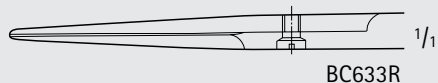

BC633R

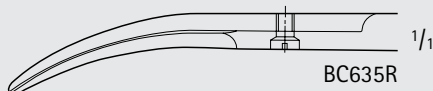

BC635R

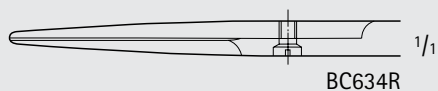

BC634R

Nerve Dissecting Scissors

Catalog Number	Tip	Blade	Length (in.)
BC628R	S/S	CVD	6

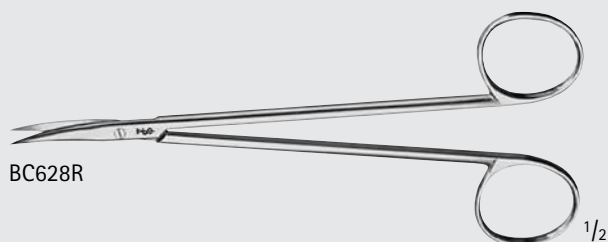

BC628R

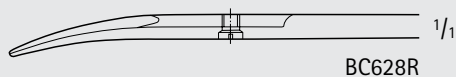

BC628R

TOENNIS-ADSON Dissecting Scissors

Catalog Number	Tip	Blade	Length (in.)
BC630R	X-DEL	CVD	6 7/8
BC631R	DEL	CVD	6 7/8

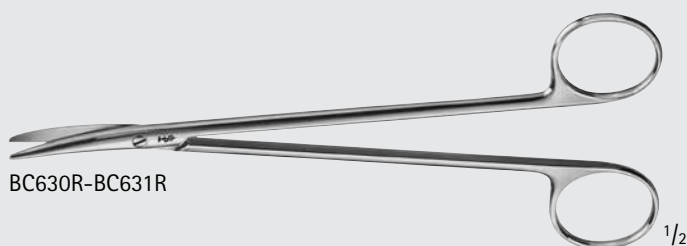

BC630R-BC631R

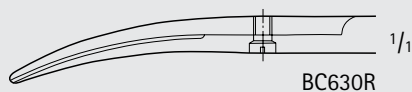

BC630R

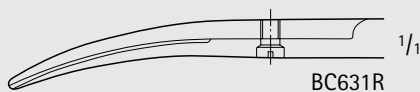

BC631R

General Surgery

Scissors

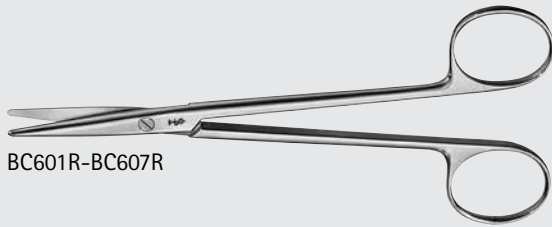
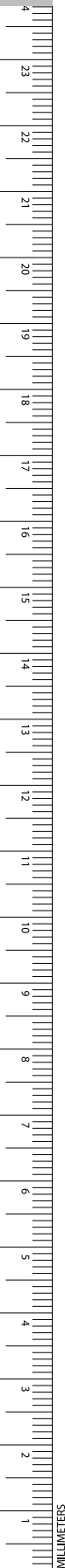

BC601R-BC607R

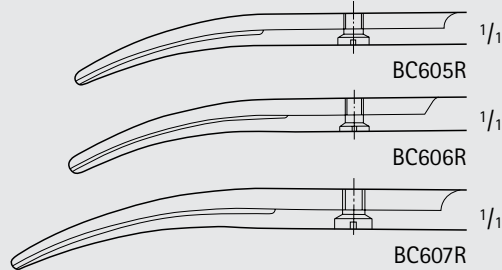
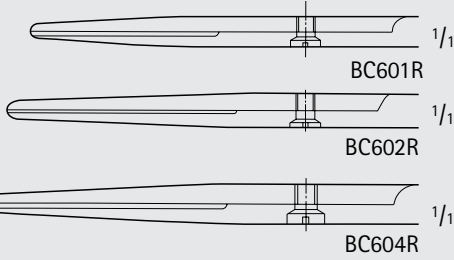

METZENBAUM Dissecting Scissors

Catalog Number	Tip	Blade	Length (in.)
BC601R	B/B	STR	5 3/4
BC602R	B/B	STR	7
BC604R	B/B	STR	7 7/8
BC605R	B/B	CVD	5 3/4
BC606R	B/B	CVD	7
BC607R	B/B	CVD	7 7/8



BC600R-BC603R

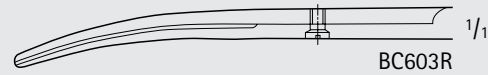
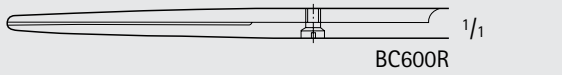

Baby METZENBAUM Dissecting Scissors, Delicate

Catalog Number	Tip	Blade	Length (in.)
BC600R	B/B	STR	5 3/4
BC603R	B/B	CVD	5 3/4

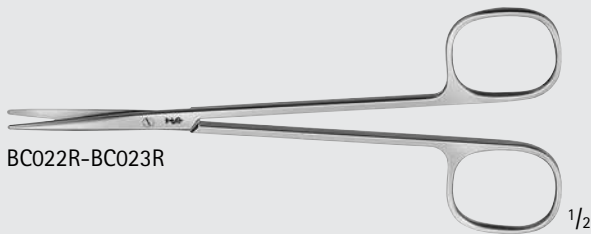

BC022R-BC023R

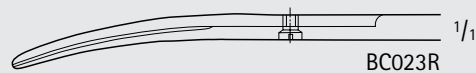
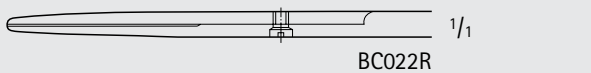

Baby METZENBAUM Dissecting Scissors

Catalog Number	Tip	Blade	Length (in.)
BC022R	B/B	STR	5 3/4
BC023R	B/B	CVD	5 3/4

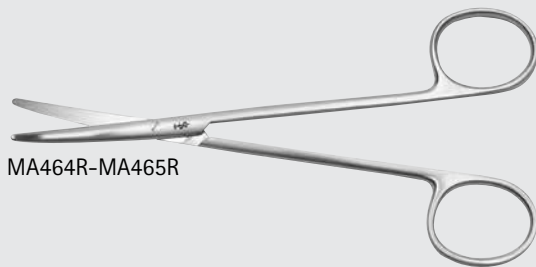

MA464R-MA465R

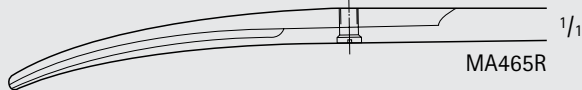

METZENBAUM Scissors, Delicate

Catalog Number	Tip	Blade	Length (in.)
MA464R	B/B	CVD	5 1/2
MA465R	B/B	CVD	8

NELSON-METZENBAUM Dissecting Scissors

Catalog Number	Tip	Blade	Length (in.)
BC611R	B/B	STR	9
BC612R	B/B	STR	9 3/4
BC613R	B/B	STR	11 1/4
BC614R	B/B	STR	12
BC615R	B/B	CVD	9
BC616R	B/B	CVD	9 3/4
BC618R	B/B	CVD	11 1/4
BC619R	B/B	CVD	12
MB926R	B/B	CVD	16

BC611R-BC619R, MB926R

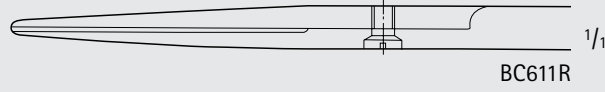
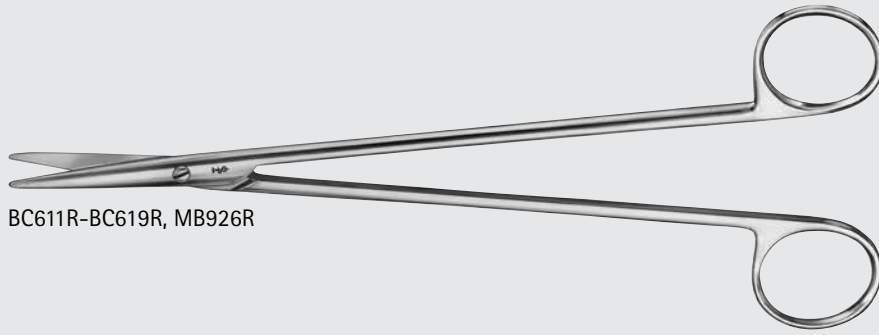

BC611R

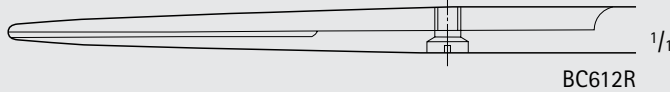

BC612R

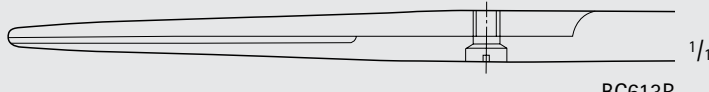

BC613R

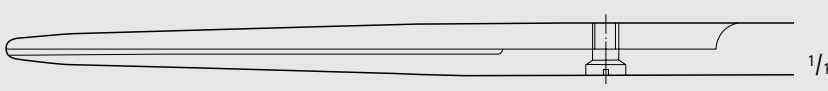

BC614R

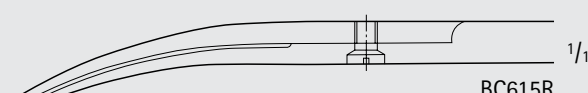

BC615R



BC616R



BC618R

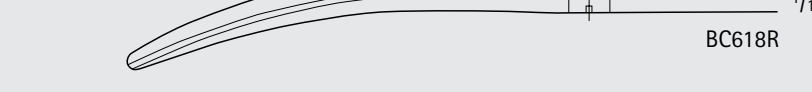

BC619R

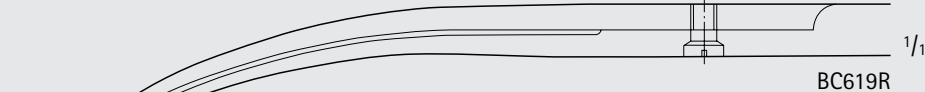

MB926R



INCHES

General Surgery

Scissors



NELSON-METZENBAUM Dissecting Scissors, Delicate

Catalog Number	Tip	Blade	Length (in.)
BC625R	B/B	CVD	13 3/4

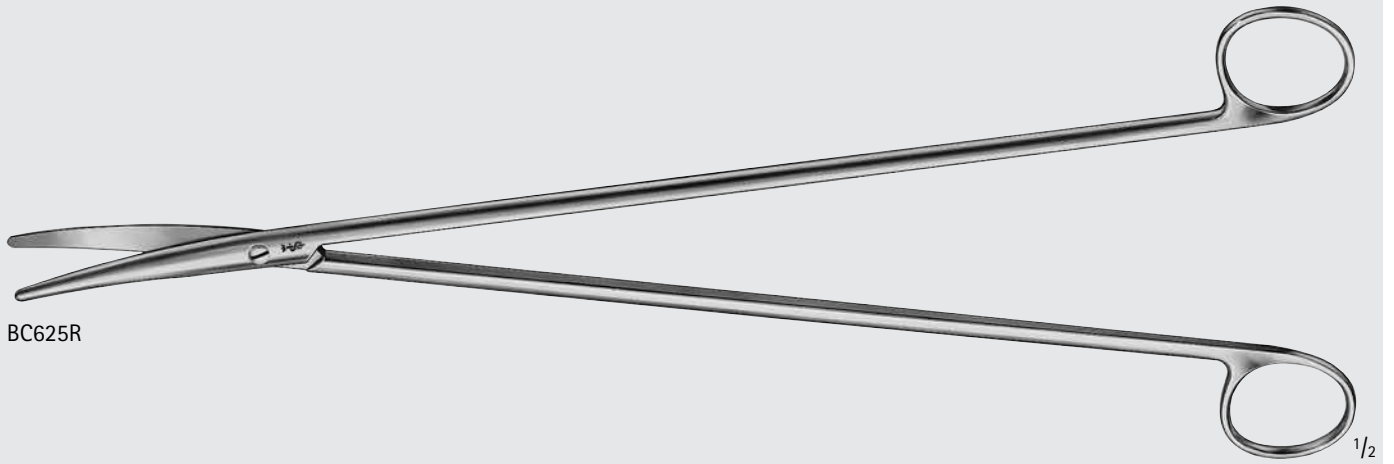

WELLER Dissecting Scissors

Catalog Number	Tip	Blade	Length (in.)
BC620R	B/B	HEAVY-CVD	11

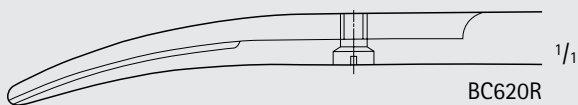
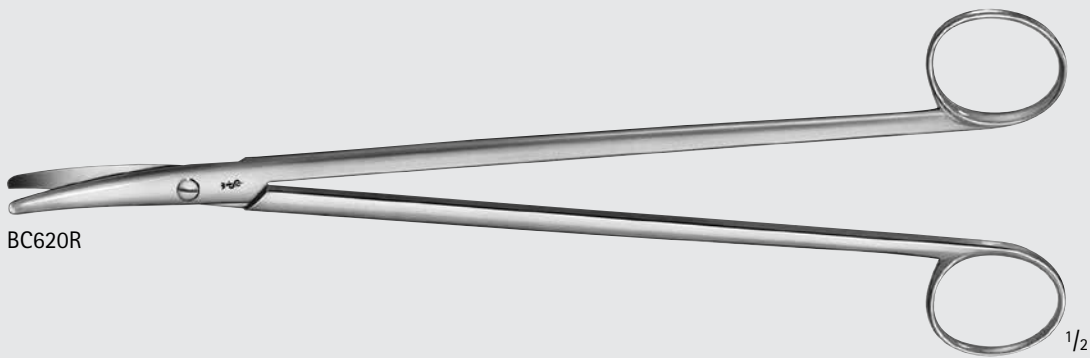

Abdominal Scissors

Catalog Number	Tip	Blade	Length (in.)
BC774R	B/B	STR	7



BC774R

1/2

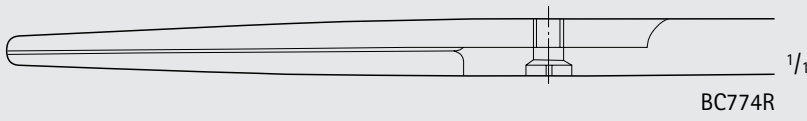

BC774R

1/1

Rectal Scissors

Catalog Number	Tip	Blade	Length (in.)
BC617R	B/B	HEAVY-CVD	12 3/4

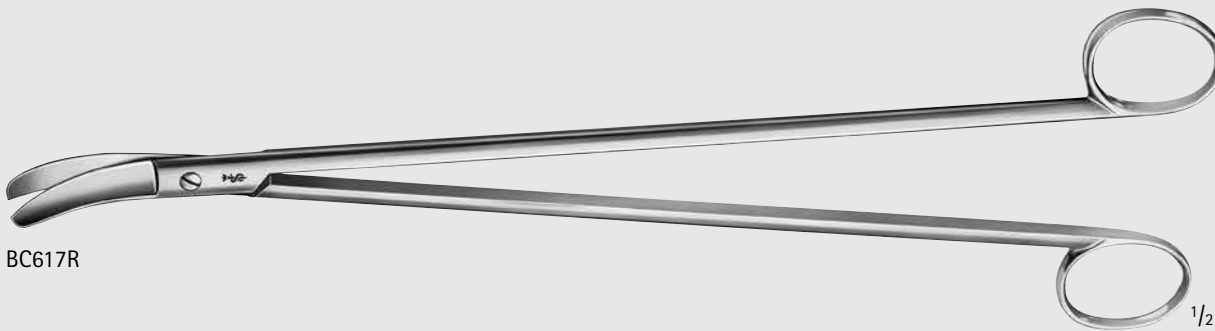

BC617R

1/2

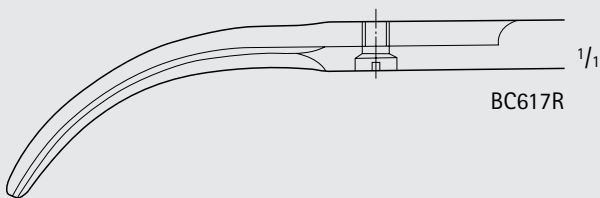

BC617R

1/1



General Surgery

Scissors



LLOYD-DAVIES Rectal Scissors

Catalog Number	Tip	Blade	Length (in.)
BC621R	B/B	CVD	10 5/8

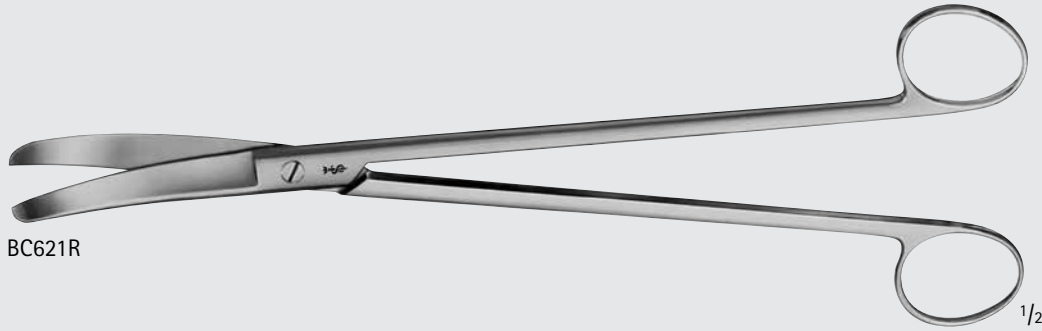

BC621R

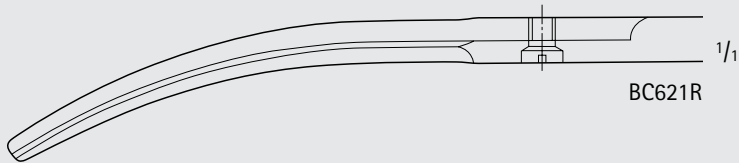

STELZNER Rectal Scissors

Catalog Number	Tip	Blade	Length (in.)
BC622R	B/B	STR	12 1/4
BC623R	B/B	CVD	12 1/4

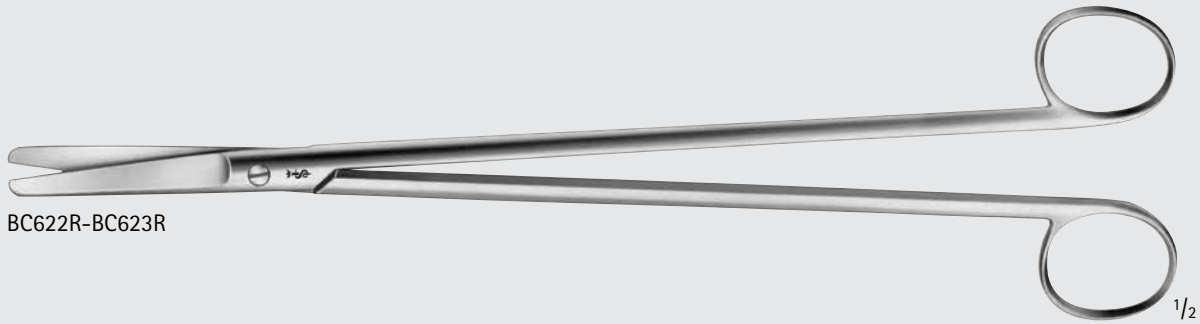

BC622R-BC623R

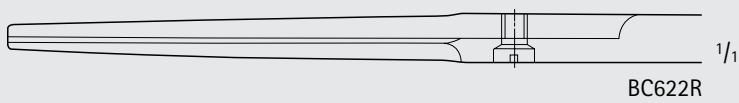

MUELLER Rectal Scissors

Catalog Number	Tip	Blade	Length (in.)
BC627R	B/B	CVD	12 3/4

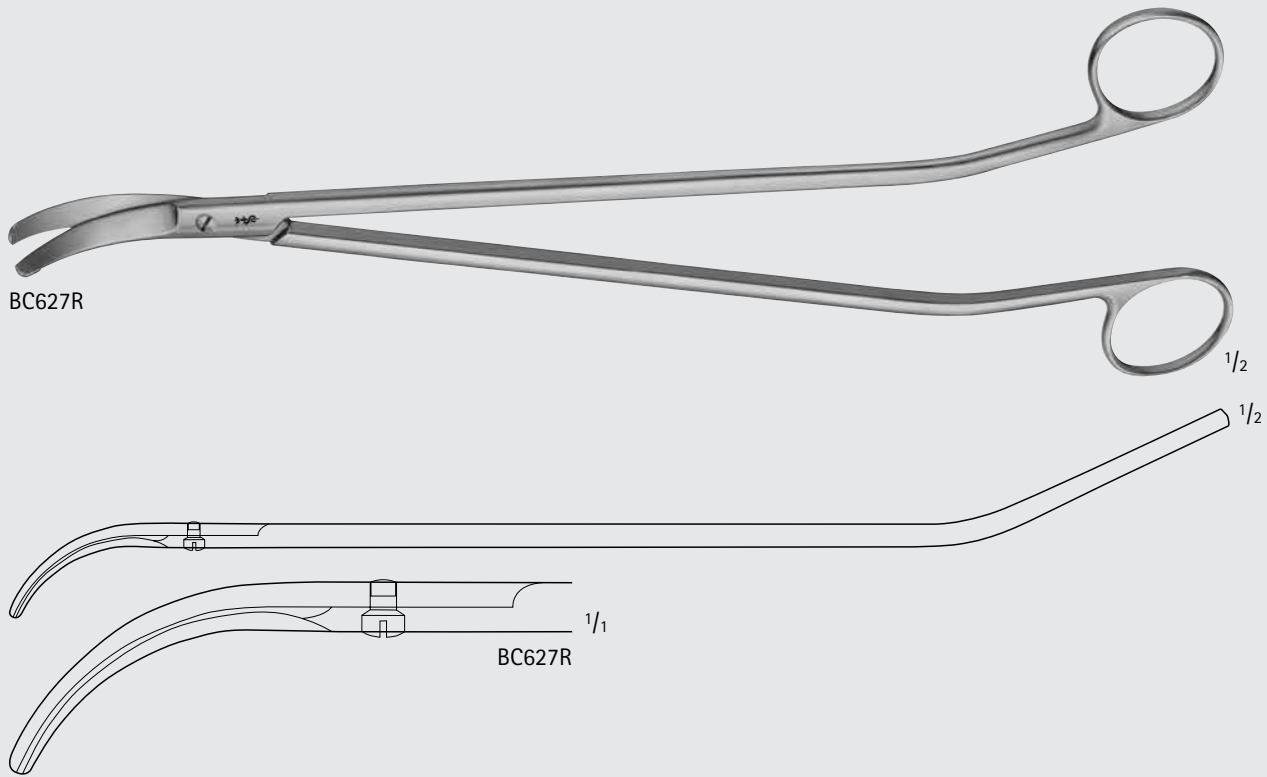

HARVEY Wire Scissors

Catalog Number	Tip	Blade	Length (in.)
BC815R	B/B	SERR	5

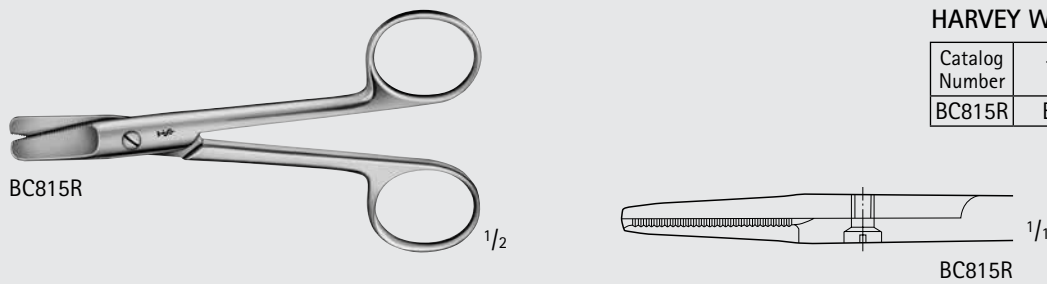

Wire Cutting Scissors

Catalog Number	For Wire Size	Length (in.)
DP551R	SOFT, UP TO 1.2MM AND HARD, UP TO 0.6 MM	4 3/4

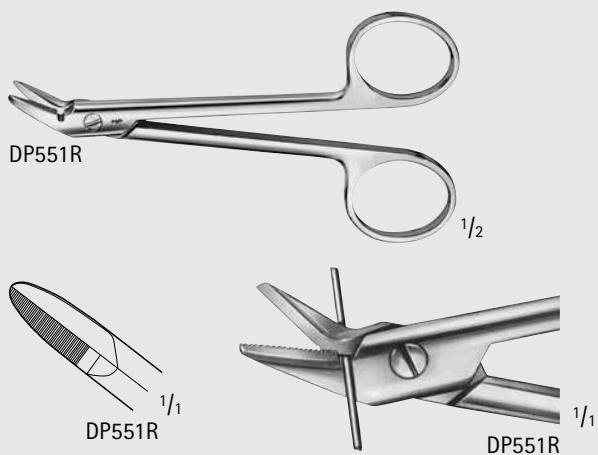

General Surgery

Delicate Scissors

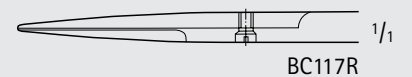
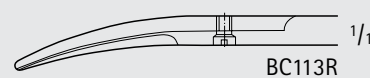
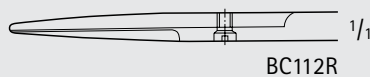
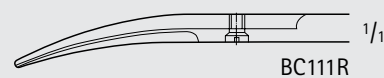
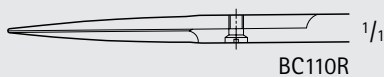
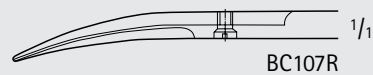
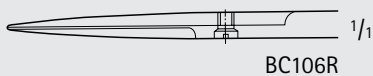
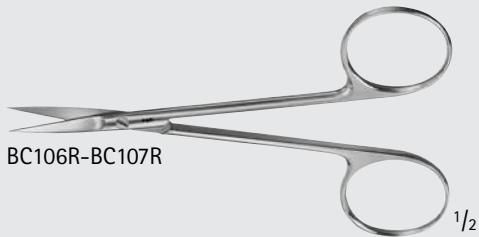
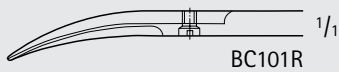
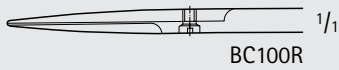
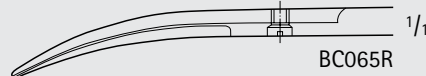
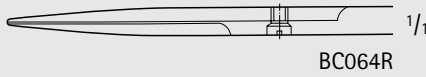

Iris Scissors

Catalog Number	Tip	Blade	Length (in.)
BC100R	S/S	STR	3 1/2
BC110R	S/S	STR	4 1/4
BC106R	S/S	STR	4 1/2
BC064R	S/S	STR	4 3/4
BC101R	S/S	CVD	3 1/2
BC111R	S/S	CVD	4 1/4
BC107R	S/S	CVD	4 1/2
BC065R	S/S	CVD	4 3/4
BC112R	S/B	STR	4 1/4
BC113R	S/B	CVD	4 1/4
BC117R	S/S	LAT-ANG	4 1/4

REYNOLDS-JAMESON Tenotomy Scissors

Catalog Number	Tip	Blade	Handle	Length (in.)
BC015R	B/B	CVD	SQUARE	5 1/2

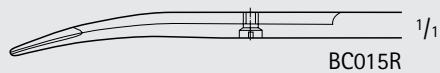
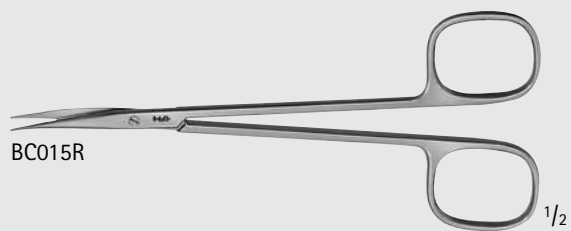

Strabismus Scissors

Catalog Number	Tip	Blade	Length (in.)
BC164R	B/B	STR	4 1/2
BC165R	B/B	CVD	4 1/2

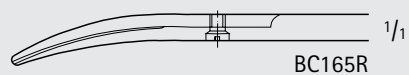
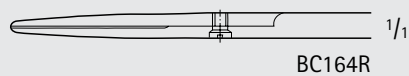

General Surgery

Delicate Scissors

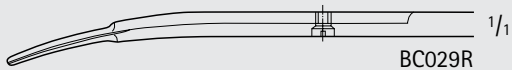
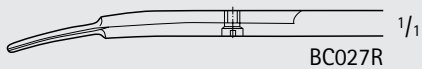
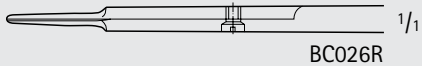
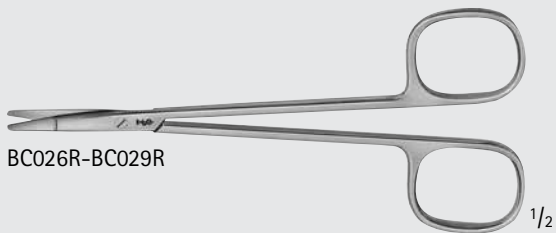

RAGNELL Dissecting Scissors

Catalog Number	Tip	Blade	Length (in.)
BC026R	B/B	STR	5 1/4
BC027R	B/B	CVD	5 1/4
BC029R	B/B	CVD	6

CHADWICK Scissors, Delicate

Catalog Number	Tip	Blade	Length (in.)
BC153R	S/S	CVD	4 1/2

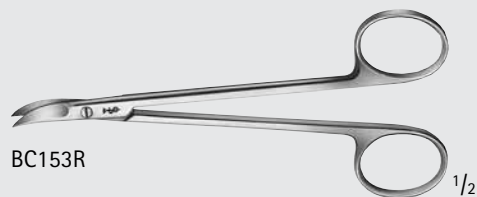

BC153R

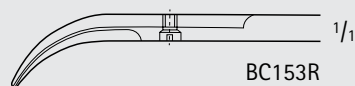

BC153R

LA GRANGE Scissors

Catalog Number	Tip	Blade	Length (in.)
BC154R	S/S	1-SERR	4 1/4

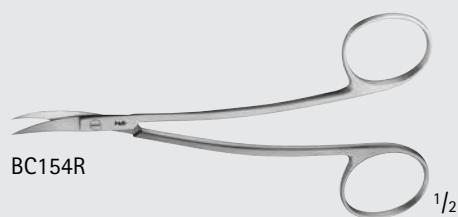

BC154R

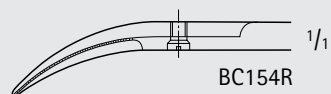

BC154R

KELLY Scissors

Catalog Number	Tip	Blade	Length (in.)
BC160R	S/S	STR	6 7/8
BC161R	S/S	CVD	6 7/8

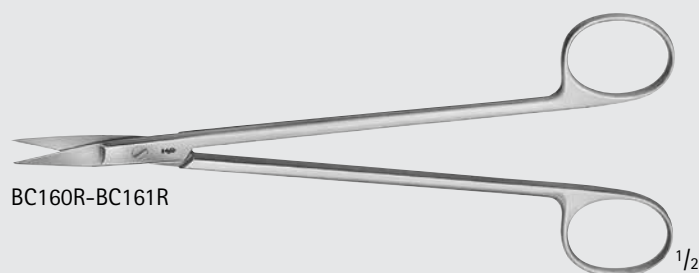

BC160R-BC161R

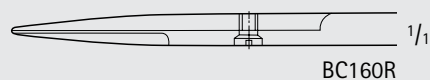

BC160R

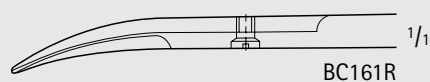

BC161R

General Surgery

Delicate Scissors

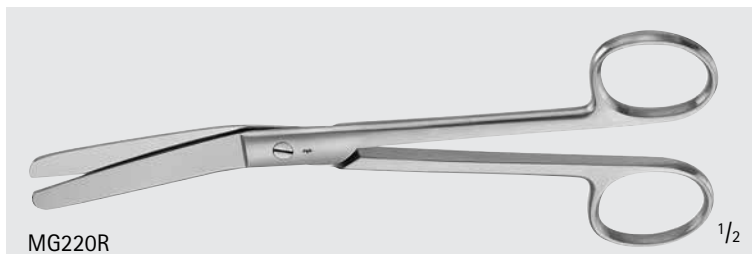

MG220R

1/2

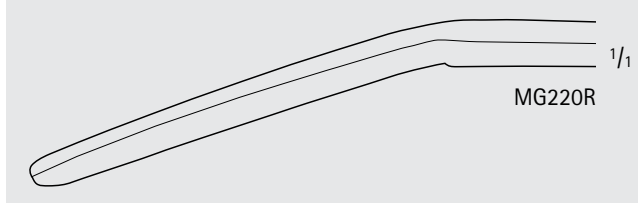

MG220R

1/1

ROCHESTER-FERGUSON Scissors

Catalog Number	Tip	Blade	Length (in.)
MG220R	B/B	ANG FLAT	7

DUROTIP Tungsten Carbide Scissors

- Excellent cutting accuracy
- Long working life
- Gold-plated rings

DUROTIP TC Suture Scissors

Catalog Number	Tip	Blade	Length (in.)
BC228R	S/S	STR	5 3/4
BC224R	S/B	STR	5 3/4
BC234R	S/B	CVD	5 3/4

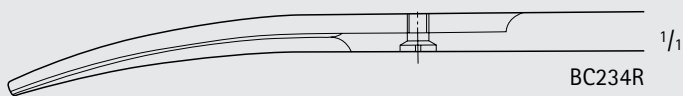
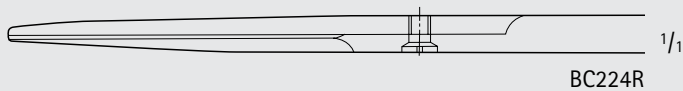
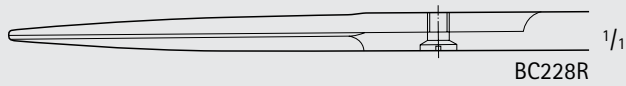

DUROTIP TC Operating Scissors

Catalog Number	Tip	Blade	Length (in.)
BC236R	S/S	STR	5 3/4
MB171R	S/S	CVD	5 3/4

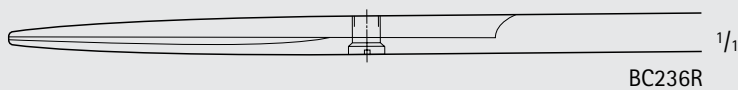
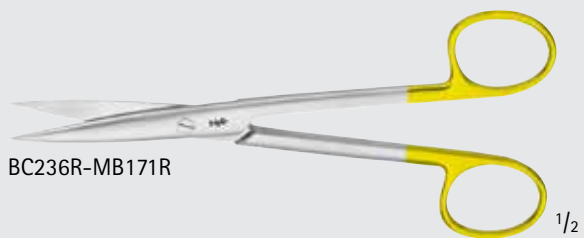

INCHES

General Surgery
DUROTIP™ TC Scissors

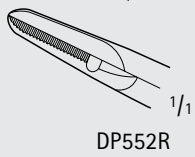
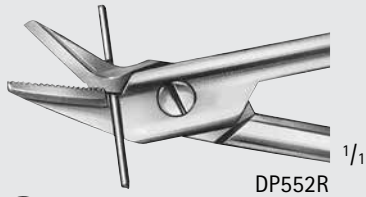
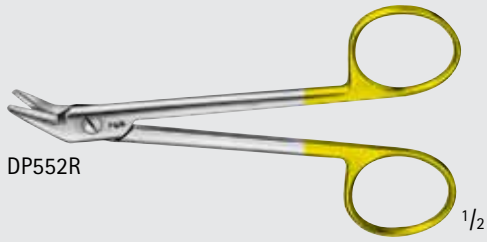

DUROTIP TC Wire Cutting Scissors

Catalog Number	Blade	For Wire Size	Length (in.)
DP552R	1-SERR	SOFT, UP TO 1.2 MM AND HARD, UP TO 0.8 MM	4 3/4

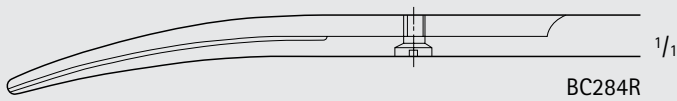
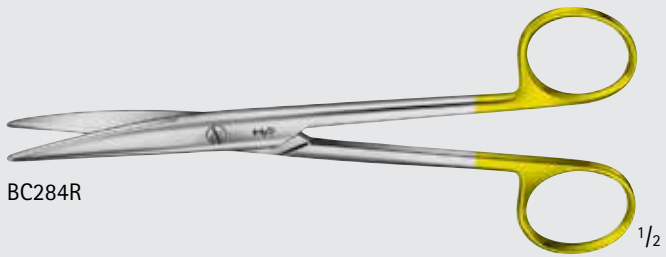

DUROTIP TC MAYO-LEXER Dissecting Scissors, Round Blades

Catalog Number	Tip	Blade	Length (in.)
BC284R	B/B	CVD	6 1/2



BC240R-BC243R

**DUROTIP TC MAYO Dissecting Scissors,
Round Blades**

Catalog Number	Tip	Blade	Length (in.)
BC240R	B/B	STR	5 1/2
BC242R	B/B	STR	6 3/4
BC241R	B/B	CVD	5 1/2
BC243R	B/B	CVD	6 3/4

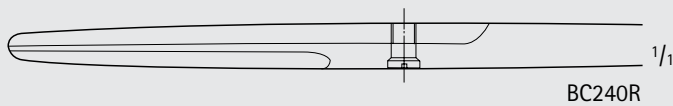

BC240R

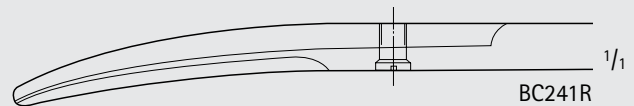

BC241R

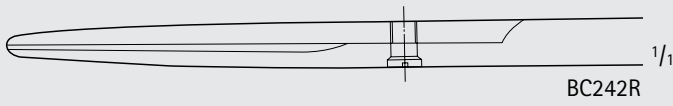

BC242R



BC243R

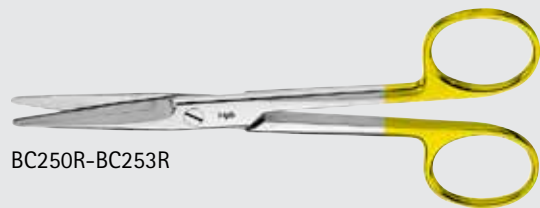

BC250R-BC253R

**DUROTIP TC MAYO Dissecting Scissors,
Beveled Blades**

Catalog Number	Tip	Blade	Length (in.)
BC250R	B/B	STR	5 1/2
BC252R	B/B	STR	6 3/4
BC251R	B/B	CVD	5 1/2
BC253R	B/B	CVD	6 3/4

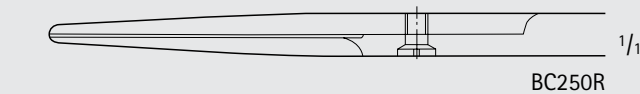

BC250R

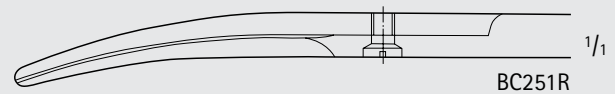

BC251R

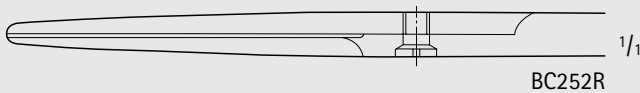

BC252R

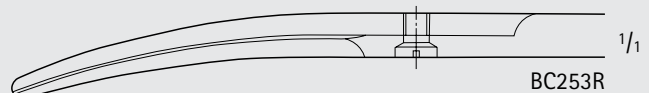

BC253R



INCHES

General Surgery
DUROTIP™ TC Scissors

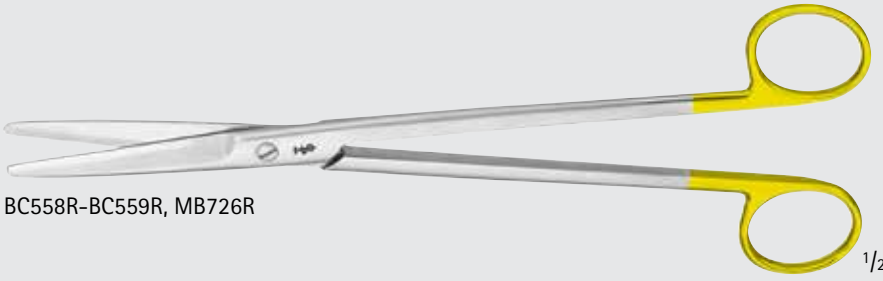
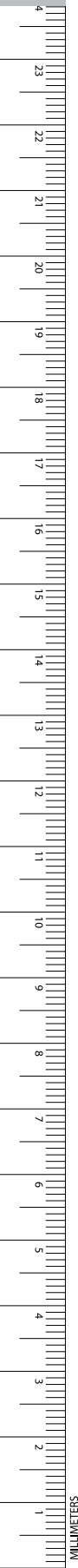

BC558R-BC559R, MB726R

DUROTIP TC MAYO Dissecting Scissors

Catalog Number	Tip	Blade	Length (in.)
BC558R	B/B	STR	9
MG215R	B/B	STR	14
BC559R	B/B	CVD	9
MB726R	B/B	CVD	14

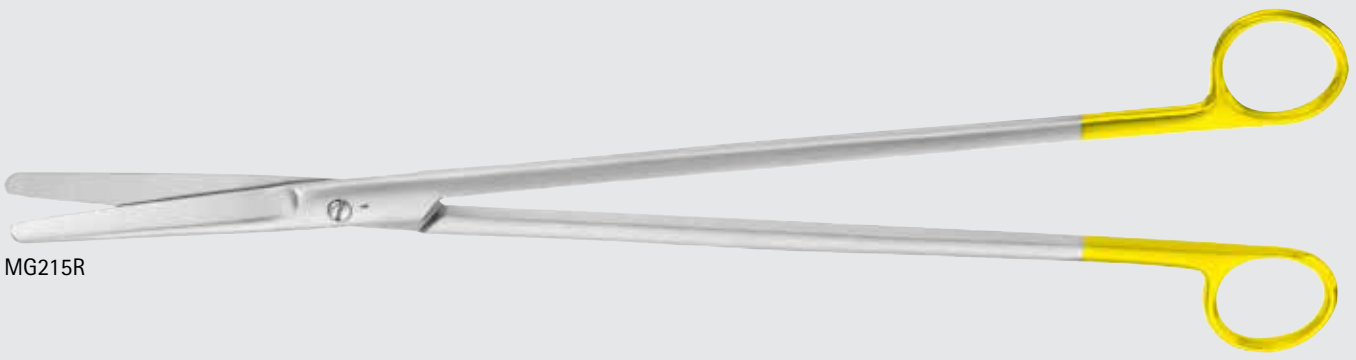
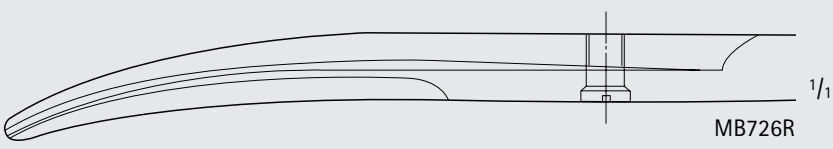
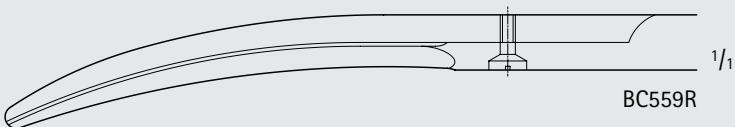
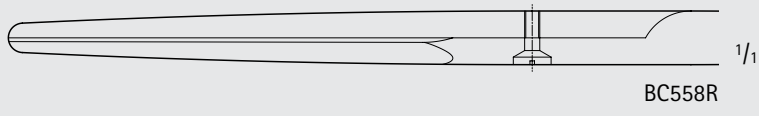

MG215R

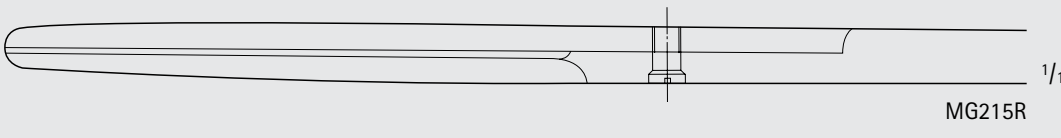

DUROTIP TC METZENBAUM Dissecting Scissors, Delicate

Catalog Number	Tip	Blade	Length (in.)
MB205R	S/S	STR	9 1/4
MB207R	S/S	CVD	5 3/4
MD496	S/S	CVD	7
MB206R	S/S	CVD	9 1/4

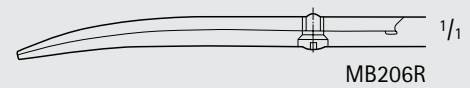
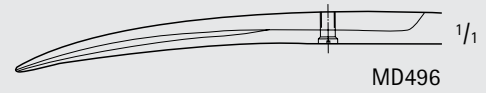
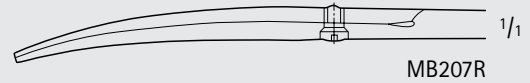
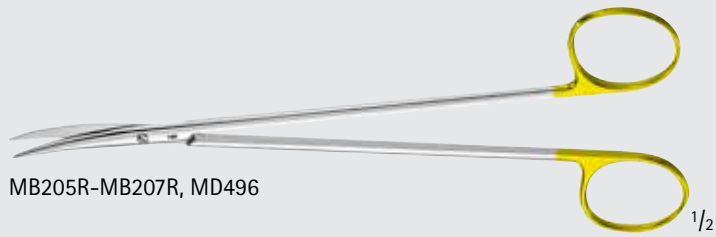

DUROTIP TC METZENBAUM Dissecting Scissors

Catalog Number	Tip	Blade	Length (in.)
BC260R	B/B	STR	5 3/4
BC262R	B/B	STR	7
BC261R	B/B	CVD	5 3/4
BC263R	B/B	CVD	7
BC265R	B/B	CVD	7 7/8

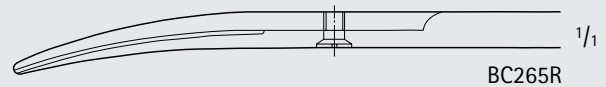
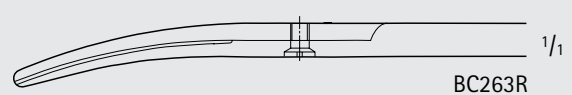
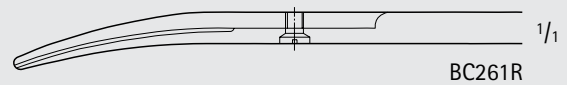
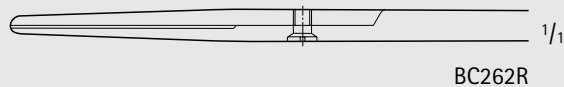
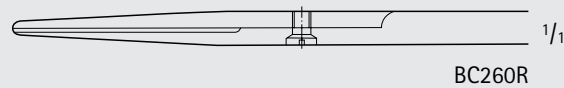

General Surgery

DUROTIP™ TC Scissors



BC287R

1/2

1/1

BC287R

DUROTIP TC METZENBAUM Dissecting Scissors

Catalog Number	Tip	Blade	Length (in.)
BC287R	B/B	CVD	9

BC270R-BC277R

1/2

1/1

BC270R

BC274R

BC276R

BC271R

BC275R

BC277R

DUROTIP TC METZENBAUM Dissecting Scissors, Delicate

Catalog Number	Tip	Blade	Length (in.)
BC270R	B/B	STR	7
BC274R	B/B	STR	7 7/8
BC276R	B/B	STR	9
BC271R	B/B	CVD	7
BC275R	B/B	CVD	7 7/8
BC277R	B/B	CVD	9

**DUROTIP TC Baby METZENBAUM
Dissecting Scissors, Delicate**

Catalog Number	Tip	Blade	Length (in.)
BC258R	B/B	STR	5 3/4
BC259R	B/B	CVD	5 3/4



BC258R-BC259R

1/2

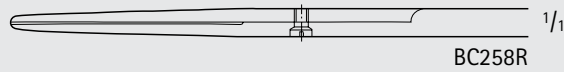

BC258R

1/1

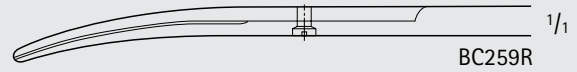

BC259R

1/1

**DUROTIP TC NELSON-METZENBAUM
Dissecting Scissors**

Catalog Number	Tip	Blade	Length (in.)
BC266R	B/B	STR	9
BC267R	B/B	CVD	9
BC279R	B/B	CVD	10 1/4
BC281R	B/B	CVD	11
BC282R	B/B	CVD	11 1/4
BC289R	B/B	CVD	11 3/4
BC285R	B/B	CVD	13 3/4

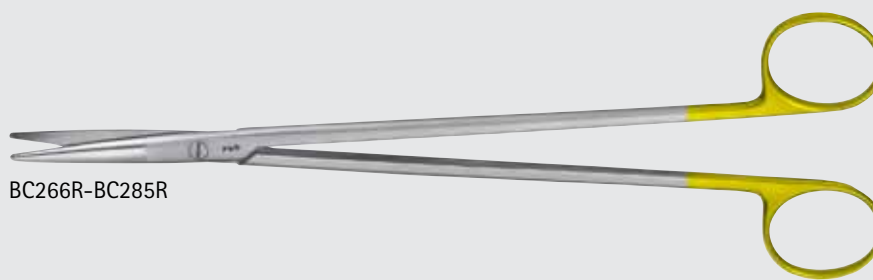

BC266R-BC285R

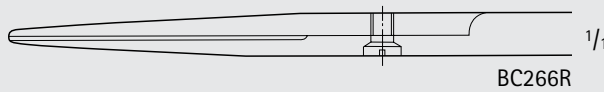

BC266R

1/1

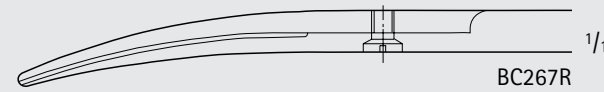

BC267R

1/1

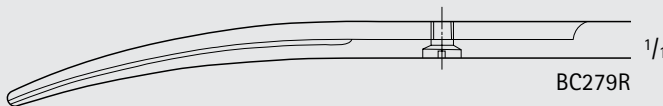

BC279R

1/1

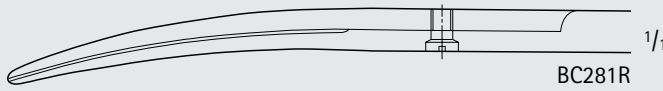

BC281R

1/1

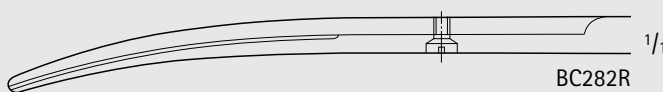

BC282R

1/1

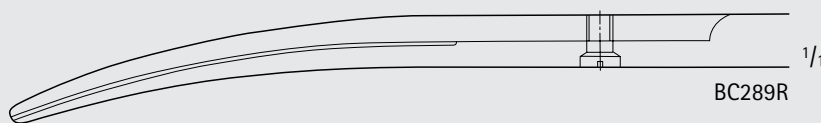

BC289R

1/1

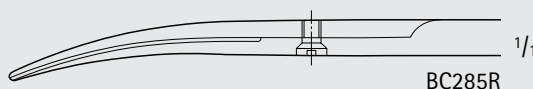

BC285R

1/1



INCHES

General Surgery
DUROTIP™ TC Scissors

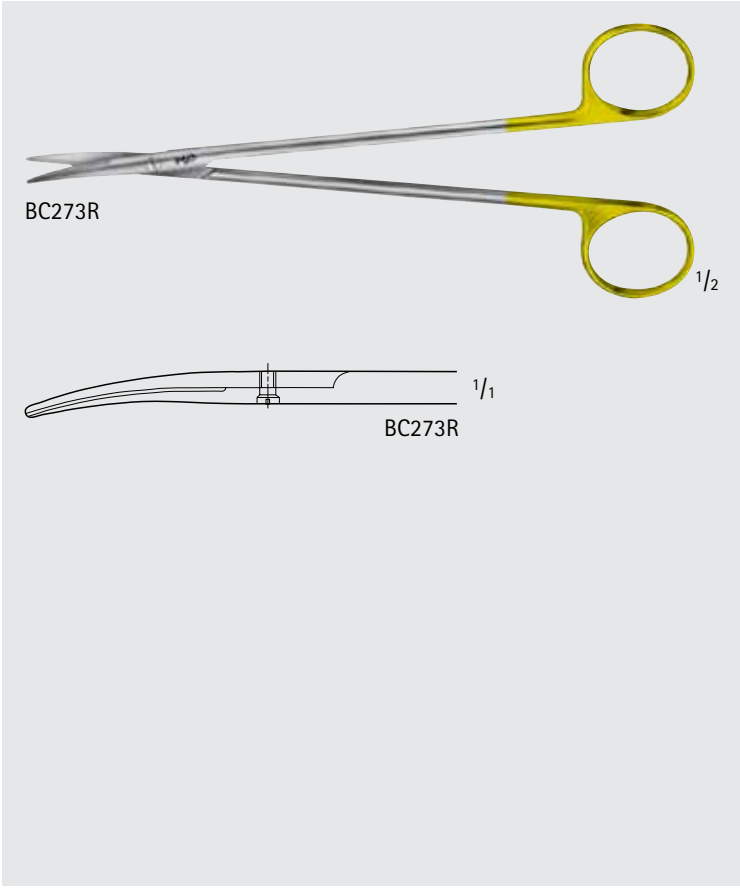
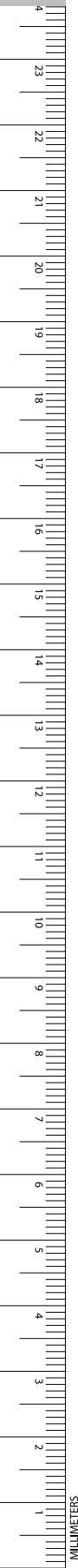

DUROTIP TC TOENNIS-ADSON
Dissecting Scissors, Delicate

Catalog Number	Tip	Blade	Length (in.)
BC273R	B/B	CVD	6 7/8

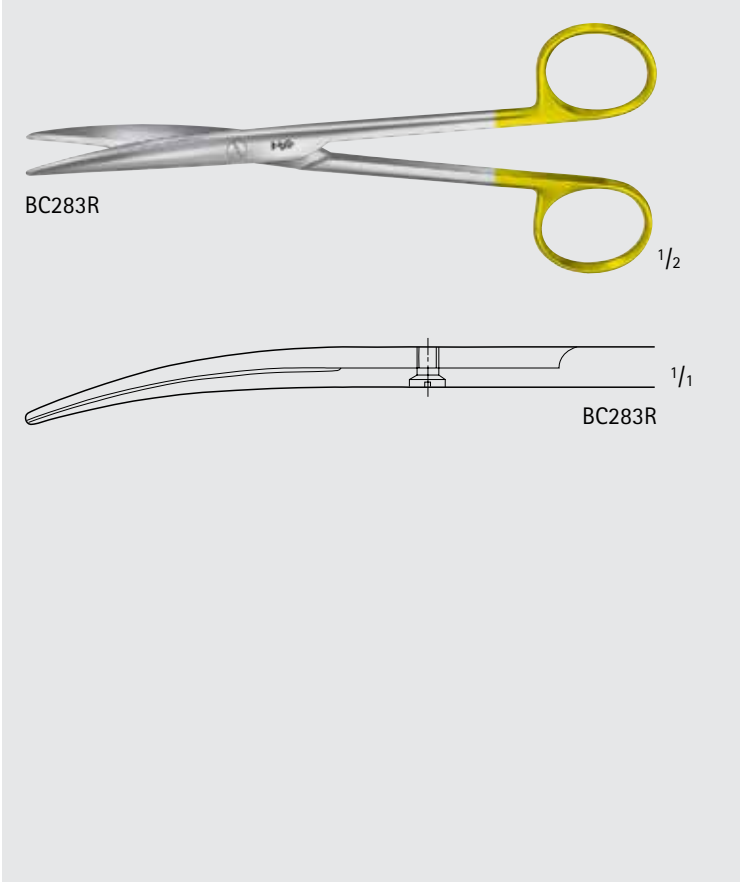

DUROTIP TC LEXER Dissecting Scissors,
Delicate

Catalog Number	Tip	Blade	Length (in.)
BC283R	B/B	CVD	6 1/2



Wavecut

■ Wavecut scissors have one serrated cutting edge to prevent tissue from slipping. The W after the item number indicates the scissors are the wavecut style, e.g. BC211W.



BC253W

1/2

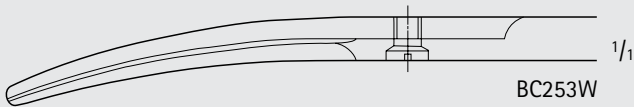

BC253W

1/1

DUROTIP TC MAYO Wavecut Dissecting Scissors, Beveled Blades

Catalog Number	Tip	Blade	Length (in.)
BC253W	B/B	CVD	6 3/4



BC259W

1/2

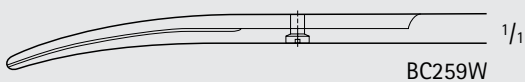

BC259W

1/1

DUROTIP TC Baby METZENBAUM Wavecut Dissecting Scissors, Delicate

Catalog Number	Tip	Blade	Length (in.)
BC259W	B/B	CVD	5 3/4



General Surgery

DUROTIP™ TC Scissors



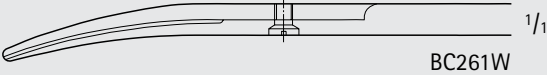

BC261W-BC265W

Catalog Number	Tip	Blade	Length (in.)
BC261W	B/B	CVD	5 3/4
BC263W	B/B	CVD	7
BC265W	B/B	CVD	7 7/8

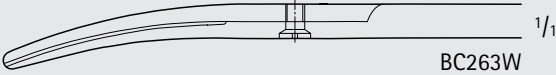

BC261W 1/1



BC263W 1/1

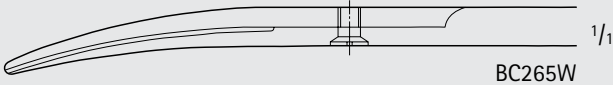

BC265W 1/1

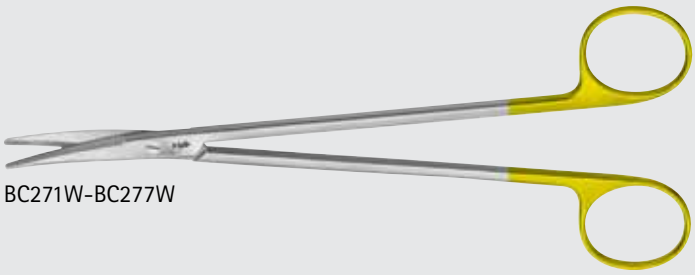

BC271W-BC277W

Catalog Number	Tip	Blade	Length (in.)
BC271W	B/B	CVD	7
BC275W	B/B	CVD	7 7/8
BC277W	B/B	CVD	9

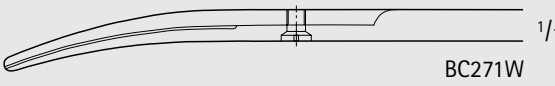

BC271W 1/1

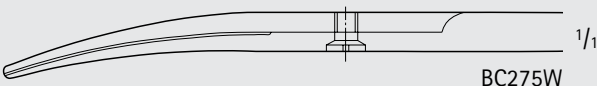

BC275W 1/1

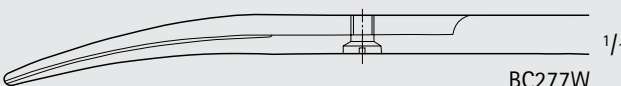

BC277W 1/1



BC287W

Catalog Number	Tip	Blade	Length (in.)
BC287W	B/B	CVD	9

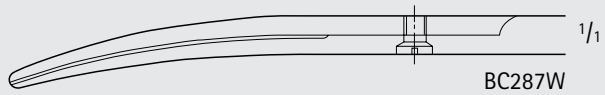

BC287W 1/1

**DUROTIP TC TOENNIS-ADSON Wavecut
 Dissecting Scissors**

Catalog Number	Tip	Blade	Length (in.)
BC273W	B/B	CVD	6 7/8

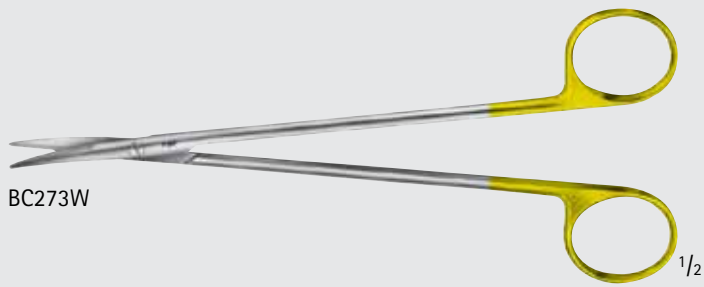

BC273W

1/2

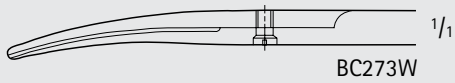

BC273W

1/16

**DUROTIP TC NELSON-METZENBAUM
 Wavecut Dissecting Scissors**

Catalog Number	Tip	Blade	Length (in.)
BC267W	B/B	CVD	9
BC279W	B/B	CVD	10 1/4
BC281W	B/B	CVD	11

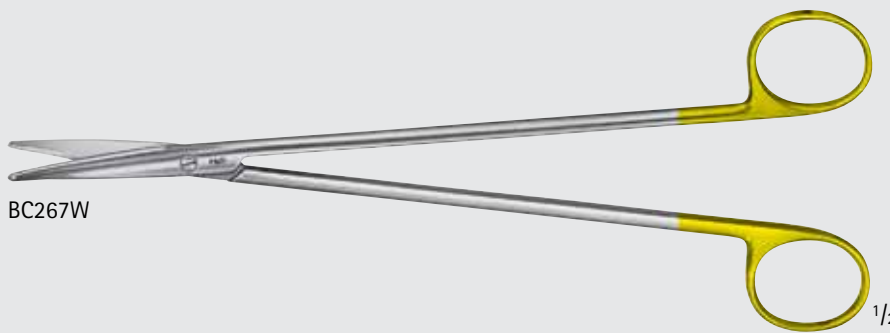

BC267W

1/2

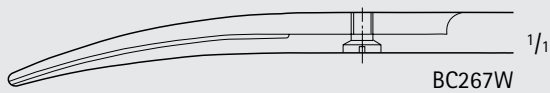

BC267W

1/16

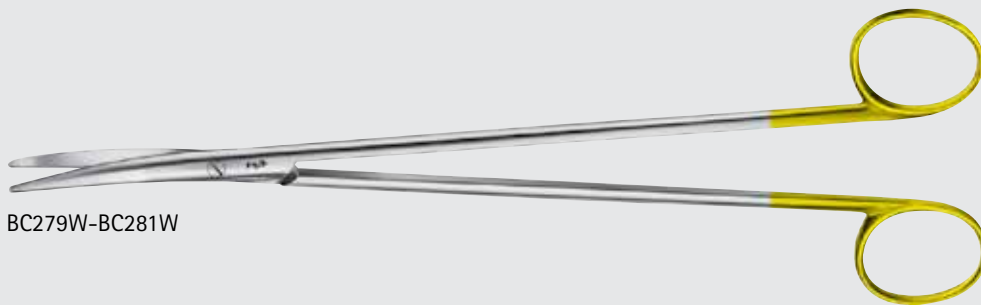

BC279W-BC281W

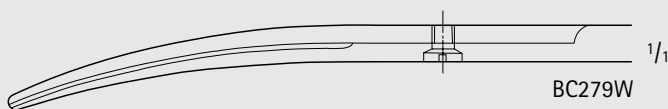

BC279W

1/16

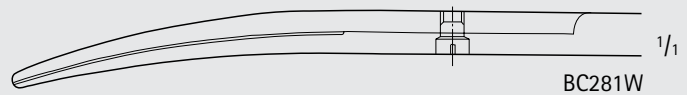

BC281W

1/16



INCHES

General Surgery
DUROTIP™ TC Scissors

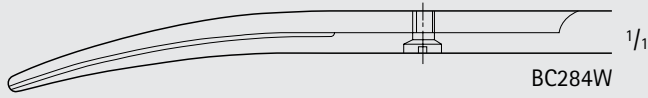
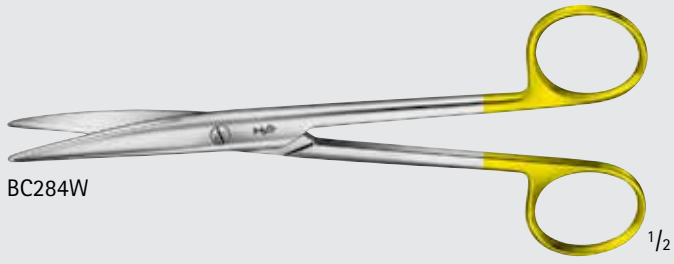
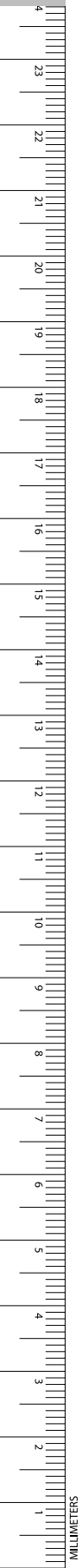

DUROTIP TC MAYO-LEXER Wavecut Scissors

Catalog Number	Tip	Blade	Length (in.)
BC284W	B/B	CVD	6 1/2

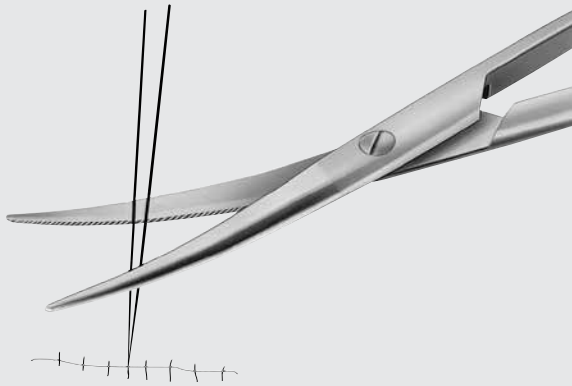

DUROTIP TC Ligature Scissors

- Carbide inserts guarantee permanent sharp cutting edge (also in the distal area of the blades).
- Wavecut prevents suture materials from slipping.
- Identified by 1 gold-plated ring.



BC294W-BC298W

DUROTIP TC Ligature Wavecut Scissors

Catalog Number	Tip	Blade	Length (in.)
BC294W	B/B	CVD	5 3/4
BC295W	B/B	CVD	7
BC296W	B/B	CVD	9
BC297W	B/B	CVD	10 1/4
BC298W	B/B	CVD	13 3/4

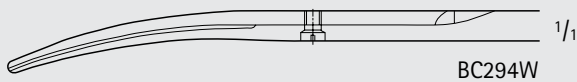

BC294W

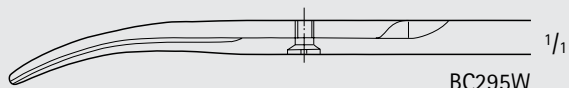

BC295W

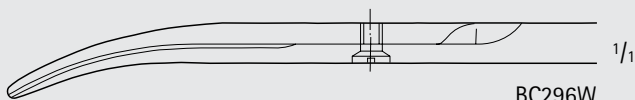

BC296W

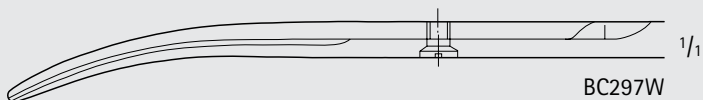

BC297W

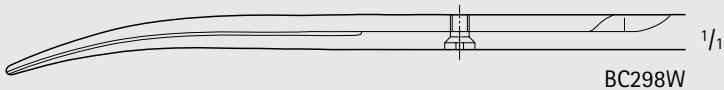

BC298W



General Surgery

SuperCut Scissors

SuperCut Scissors

Your everyday black handle scissors

- **Microtome Edge**
 - Razor sharp cutting edge facilitates gentle cutting with minimal force
- **Wavecut Blade**
 - Prevents tissue from slipping out during the cutting process

For more information about SuperCut Scissors see brochure number **DOC821**.



BC900R-BC901R

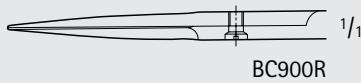

BC900R

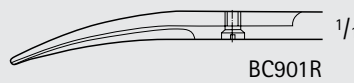

BC901R

Iris SuperCut Scissors, Delicate

Catalog Number	Tip	Blade	Length (in.)
BC900R	S/S	STR	4 1/4
BC901R	S/S	CVD	4 1/4



BC903R

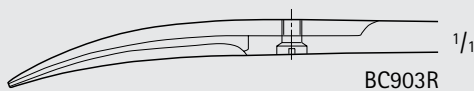

BC903R

SuperCut Plastic Standard Scissors

Catalog Number	Tip	Blade	Length (in.)
BC903R	S/S	CVD	5



BC904R-BC905R

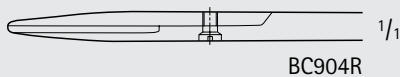

BC904R

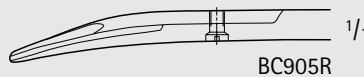

BC905R

STEVENS SuperCut Scissors

Catalog Number	Tip	Tip Size (mm)	Blade	Length (in.)
BC904R	B/B	12	STR	4 1/8
BC905R	B/B	12	CVD	4 1/8

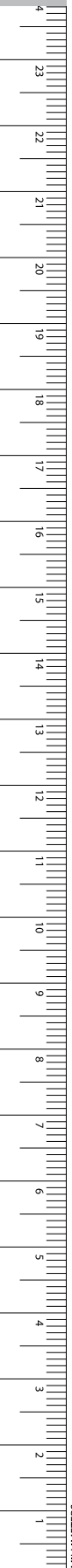

STEVENS SuperCut Scissors (continued)

Catalog Number	Tip	Tip Size (mm)	Blade	Length (in.)
BC906R	B/B	13	STR	4 1/4
BC907R	B/B	13	CVD	4 1/4

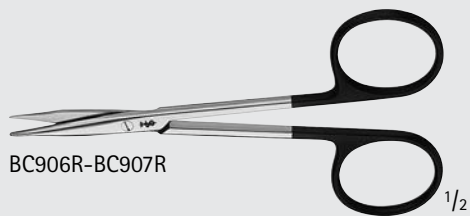

BC906R-BC907R

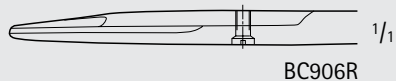

BC906R

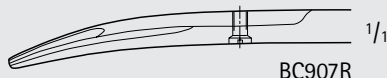

BC907R

GOLDMANN-FOX SuperCut Scissors

Catalog Number	Tip	Blade	Length (in.)
BC909R	S/S	CVD	5 1/8



BC909R

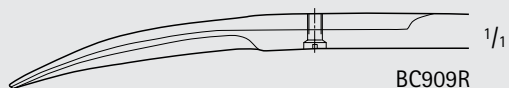

BC909R

General Surgery

SuperCut Scissors

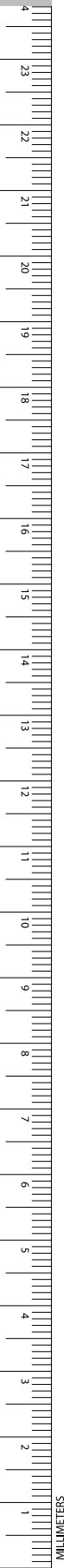

JAMESON SuperCut Scissors, Delicate

Catalog Number	Tip	Blade	Length (in.)
BC911R	B/B	CVD	5 1/8
BC915R	B/B	CVD	6
BC919R	B/B	CVD	7

BC911R $1/2$

BC911R $1/1$

BC915R $1/2$

BC915R $1/1$

BC919R $1/2$

BC919R $1/1$

JOSEPH SuperCut Scissors, Delicate

Catalog Number	Tip	Blade	Length (in.)
BC916R	S/S	STR	6
BC917R	S/S	CVD	6

BC916R-BC917R $1/2$

BC916R $1/1$

BC917R $1/1$



GORNEY SuperCut Scissors, Delicate

Catalog Number	Tip	Blade	Length (in.)
BC920R	B/B	STR	7 3/4
BC921R	B/B	CVD	7 3/4



BC920R-BC921R

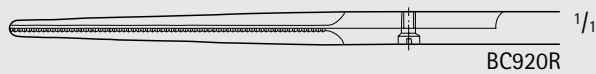

BC920R

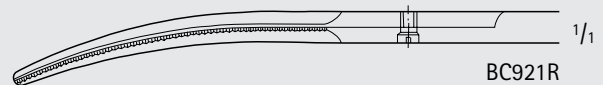

BC921R

KAYE SuperCut Facelift Scissors, Delicate

Catalog Number	Tip	Blade	Length (in.)
BC933R	B/B	CVD	7 3/4

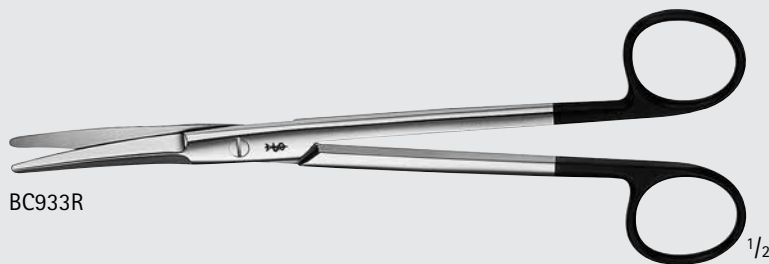

BC933R

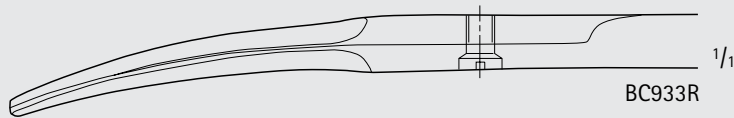

BC933R

MAYO SuperCut Scissors, Delicate

Catalog Number	Tip	Blade	Length (in.)
BC926R	B/B	STR, BEVELED	5 3/4
BC927R	B/B	CVD, BEVELED	5 3/4
BC924R	B/B	STR, ROUND	6 1/2
BC925R	B/B	CVD, ROUND	6 1/2



BC926R-BC927R

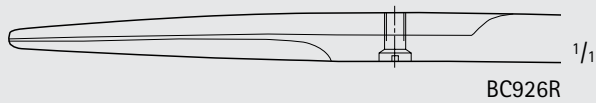

BC926R

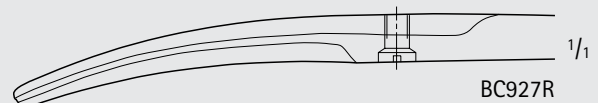

BC927R



BC924R-BC925R

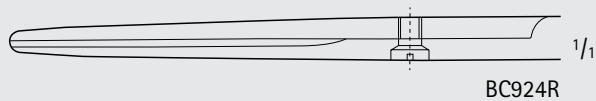

BC924R

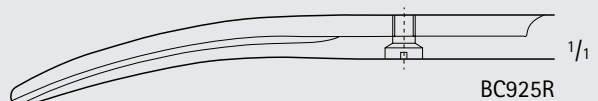

BC925R

General Surgery

SuperCut Scissors, Beveled

MAYO SuperCut Scissors, Beveled

Catalog Number	Tip	Blade	Length (in.)
MG216R	B/B	STR	9
BC922R	B/B	STR	10
BC938R	B/B	STR	12
MG087R	B/B	CVD	9
BC929R	B/B	CVD	11

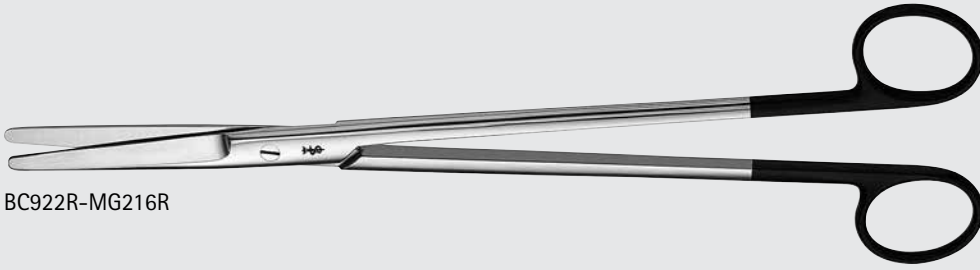

BC922R-MG216R

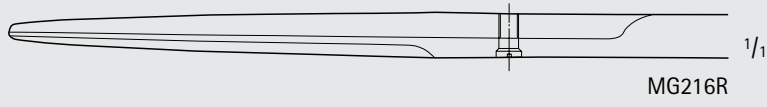

MG216R

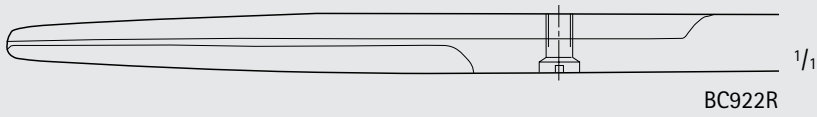

BC922R

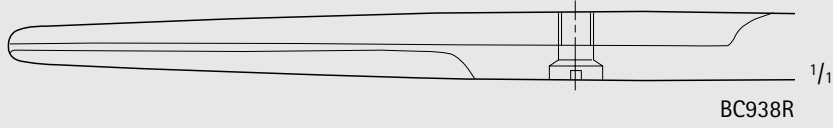

BC938R

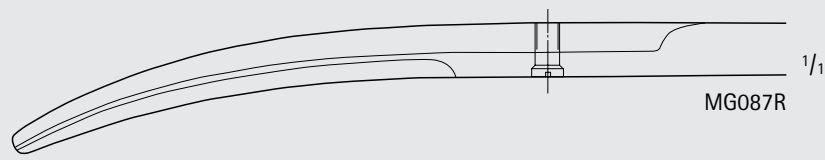

MG087R

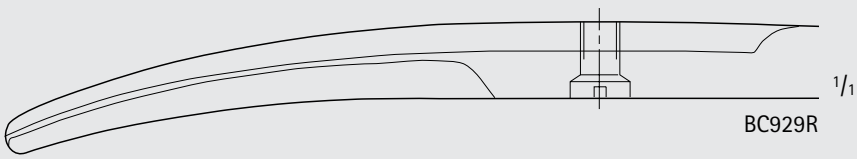

BC929R

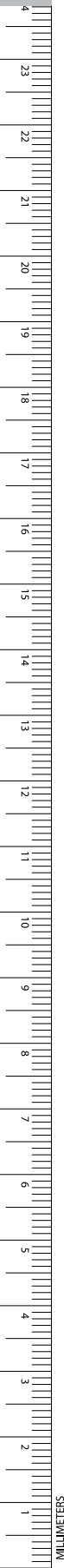

Baby METZENBAUM SuperCut
Scissors, Delicate

Catalog Number	Tip	Blade	Length (in.)
BC930R	B/B	STR	4 1/2
BC931R	B/B	CVD	4 1/2

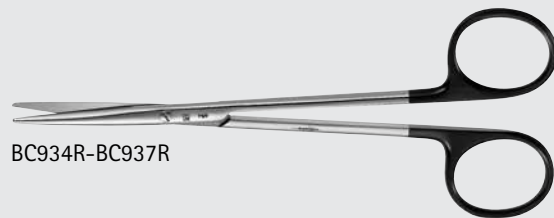
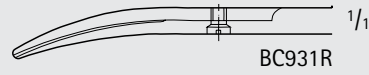
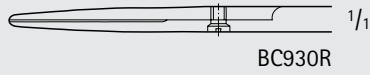

METZENBAUM SuperCut Scissors,
Delicate

Catalog Number	Tip	Blade	Length (in.)
BC934R	B/B	STR	5 3/4
BC936R	B/B	STR	7
BC935R	B/B	CVD	5 3/4
BC937R	B/B	CVD	7

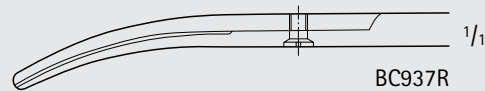
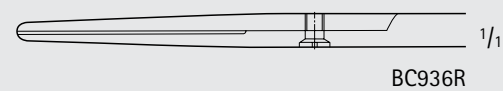
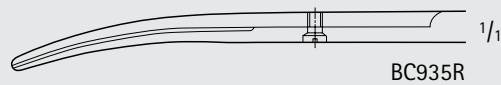
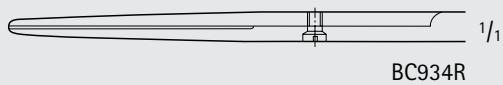

General Surgery

SuperCut Scissors

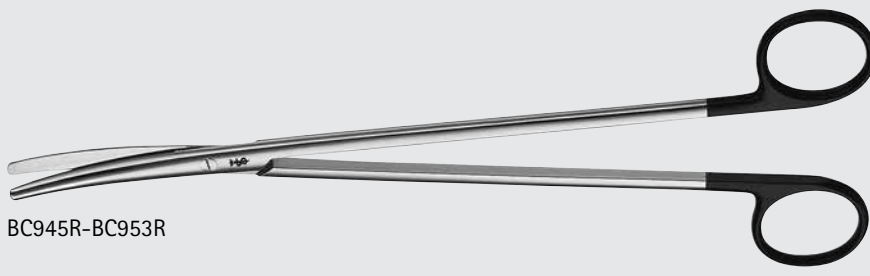

BC945R-BC953R

METZENBAUM SuperCut Scissors, Delicate

Catalog Number	Tip	Blade	Length (in.)
BC945R	B/B	CVD	9
BC947R	B/B	CVD	10 1/4
BC949R	B/B	CVD	11 1/4
BC951R	B/B	CVD	11 3/4
BC953R	B/B	CVD	14

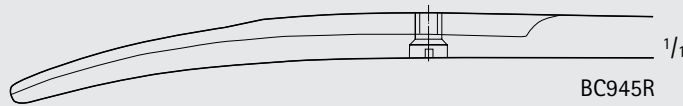

BC945R

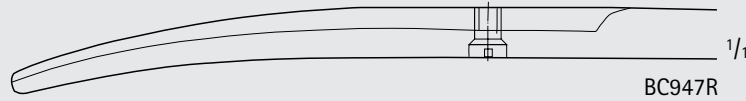

BC947R

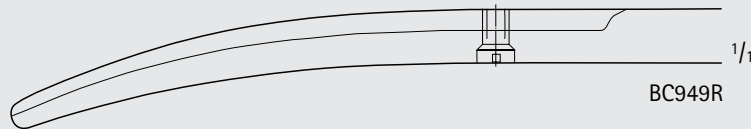

BC949R

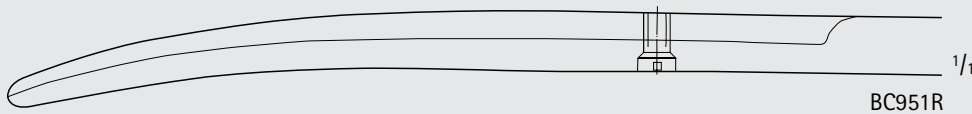

BC951R

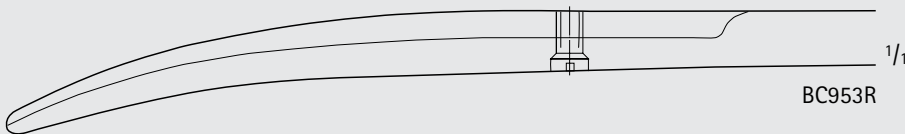

BC953R

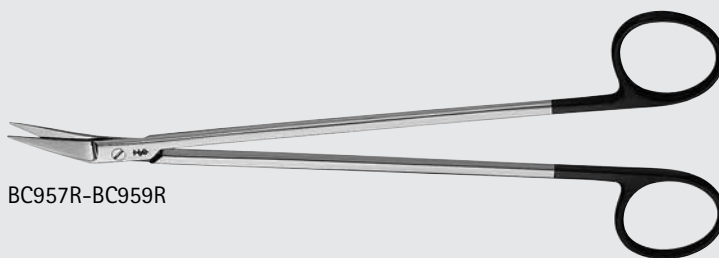

BC957R-BC959R

POTTS-SMITH SuperCut Scissors

Catalog Number	Tip	Blade Angle	Blade Size (mm)	Length (in.)
BC957R	B/B	25°	22	7 1/2
BC958R	B/B	45°	20	7 1/4
BC959R	B/B	60°	19	7



BC957R



BC958R



BC959R

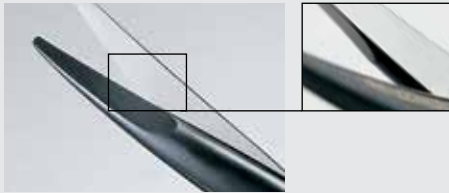

Microtome Edge

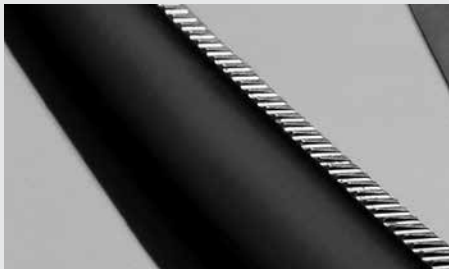

Wavecut

Noir Supreme Cut Scissors

- **Noir**
The combination of the renowned Aesculap Tungsten Carbide technology with the Aesculap Noir coating results in an extremely high surface hardness and therefore high wear resistance in daily hospital use.
- **Microtome edge**
The extremely sharp cutting edge of the scissors blade facilitates gentle cutting of tissue with minimal use of force.
- **Wavecut** prevents tissue from slipping out during the cutting process.
- The WB after the item number indicates the Noir scissors are the wavecut style, e.g. BC211WB.

For more information about Noir Supreme Cut Scissors see our brochure number DOC637.



BC252B-BC253WB

1/2



1/1

BC252B



1/1

BC253B, BC253WB

Noir MAYO Dissecting Scissors

Catalog Number	Tip	Blade	Length (in.)
BC252B	B/B	STR	6 3/4
BC253B	B/B	CVD	6 3/4
BC253WB	B/B	CVD	6 3/4



BC284B-BC284WB

1/2



1/1

BC284B-BC284WB

Noir MAYO-LEXER Dissecting Scissors

Catalog Number	Tip	Blade	Length (in.)
BC284B	B/B	CVD	6 1/2
BC284WB	B/B	CVD	6 1/2



General Surgery

Noir™ Supreme Cut Scissors





BC283B-BC283WB 1/2



BC283B-BC283WB 1/1

Noir LEXER Dissecting Scissors

Catalog Number	Tip	Blade	Length (in.)
BC283B	B/B	DEL, CVD	6 1/2
BC283WB	B/B	DEL, CVD	6 1/2



BC210B-BC211WB 1/2



BC210B 1/1



BC211B, BC211WB 1/1

Noir Iris Dissecting Scissors

Catalog Number	Tip	Blade	Length (in.)
BC210B	S/S	STR	4 1/4
BC211B	S/S	CVD	4 1/4
BC211WB	S/S	CVD	4 1/4



BC273B-BC273WB 1/2



BC273B-BC273WB 1/1

Noir TOENNIS-ADSON Dissecting Scissors

Catalog Number	Tip	Blade	Length (in.)
BC273B	B/B	DEL, CVD	6 7/8
BC273WB	B/B	DEL, CVD	6 7/8

General Surgery

Noir™ Supreme Cut Scissors

Noir METZENBAUM Dissecting Scissors

Catalog Number	Tip	Blade	Length (in.)
BC261B	B/B	CVD	5 3/4
BC261WB	B/B	CVD	5 3/4
BC263B	B/B	CVD	7
BC263WB	B/B	CVD	7
BC271B	B/B	DEL, CVD	7
BC271WB	B/B	DEL, CVD	7
BC265B	B/B	CVD	7 7/8
BC265WB	B/B	CVD	7 7/8
BC275B	B/B	DEL, CVD	7 7/8
BC275WB	B/B	DEL, CVD	7 7/8
BC267B	B/B	CVD	9
BC267WB	B/B	CVD	9
BC277B	B/B	DEL, CVD	9
BC277WB	B/B	DEL, CVD	9

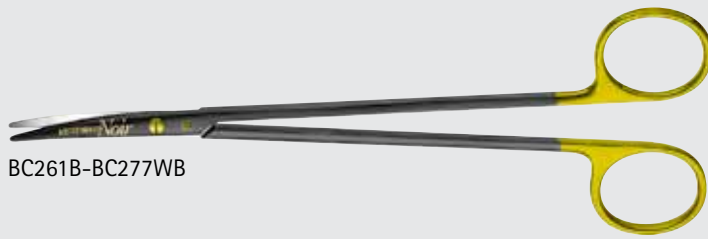

BC261B-BC277WB



BC261B, BC261WB

1/1



BC263B, BC263WB

1/1



BC271B, BC271WB

1/1



BC265B, BC265WB

1/1



BC275B, BC275WB

1/1



BC267B, BC267WB

1/1



BC277B, BC277WB

1/1



INCHES

General Surgery

Noir™ Supreme Cut Scissors

Noir NELSON-METZENBAUM Dissecting Scissors

Catalog Number	Tip	Blade	Length (in.)
BC279B	B/B	DEL, CVD	10 1/4
BC279WB	B/B	DEL, CVD	10 1/4
BC281B	B/B	DEL, CVD	11
BC281WB	B/B	DEL, CVD	11

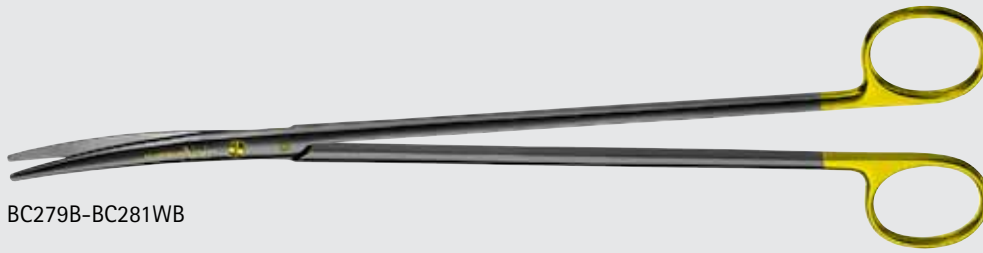

BC279B-BC281WB



BC279B, BC279WB



BC281B, BC281WB





CONVERSE Needle Holder

Catalog Number	Jaw	Length (in.)
BM200R	LONG SERR	5 1/8

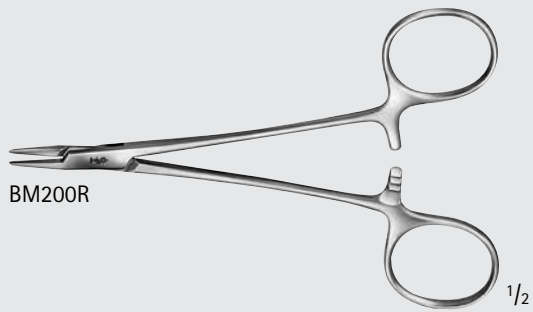

BM200R



BM200R

HALSEY Needle Holder

Catalog Number	Tip	Jaw	Length (in.)
BM201R	DEL	SMOOTH	5 1/8
BM205R	DEL	X-SERR	5 1/8

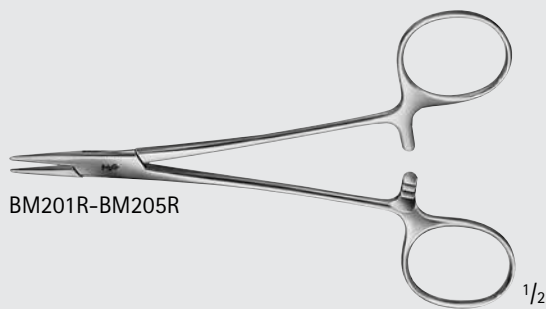

BM201R-BM205R



BM201R



BM205R

WEBSTER Needle Holder

Catalog Number	Jaw	Length (in.)
BM202R	SMOOTH	5

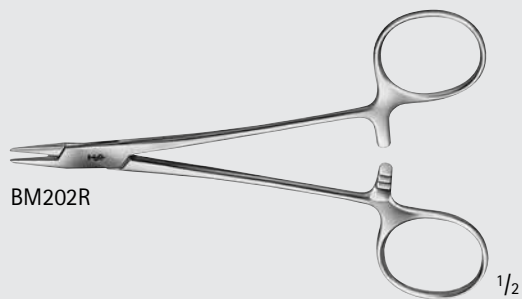

BM202R

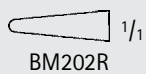

BM202R

DERF Needle Holder

Catalog Number	Jaw	Length (in.)
BM204R	SERR	5

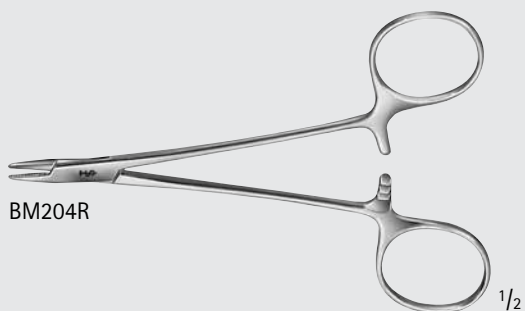

BM204R



BM204R

General Surgery

Needle Holders



BM210R

1/2



BM210R

1/1

DOYEN Needle Holder

Catalog Number	Jaw	Length (in.)
BM210R	X-SERR	5

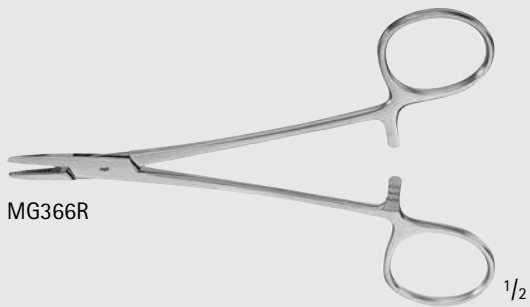

MG366R

1/2



MG366R

1/1

COLLIER Needle Holder, Fenestrated

Catalog Number	Jaw	Length (in.)
MG366R	SERR	5

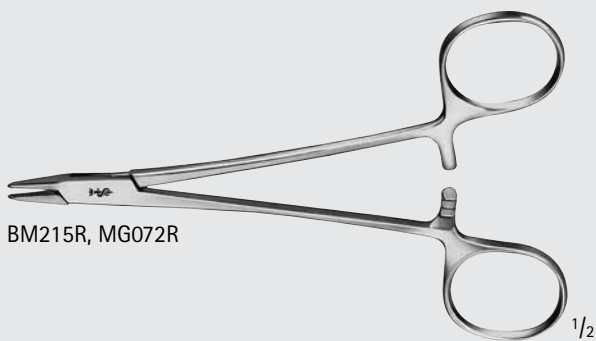

BM215R, MG072R

1/2



MG072R

1/1



BM215R

1/1

BAUMGARTNER Needle Holder

Catalog Number	Jaw	Length (in.)
MG072R	SERR, GROOVED	5 1/4
BM215R	X-SERR	5 3/4



CRILE-WOOD Needle Holder

Catalog Number	Jaw	Length (in.)
BM218R	X-SERR	6
BM220R	X-SERR	6 1/4

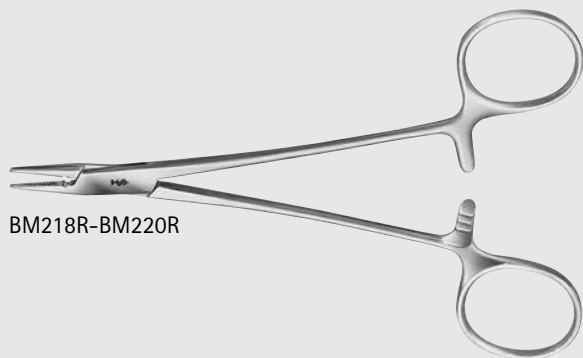

BM218R-BM220R

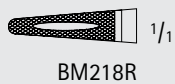

BM218R

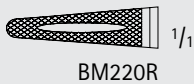

BM220R

CRILE-MURRAY Needle Holder

Catalog Number	Jaw	Length (in.)
BM219R	SERR	6

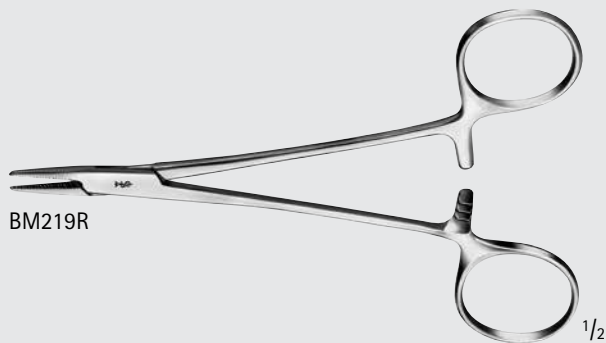

BM219R



BM219R

ADSON Needle Holder, Fenestrated

Catalog Number	Jaw	Length (in.)
BM224R	SERR	7

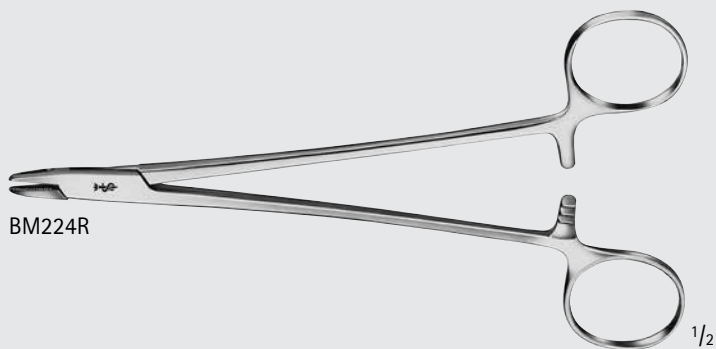

BM224R



BM224R



1/1

General Surgery

Needle Holders

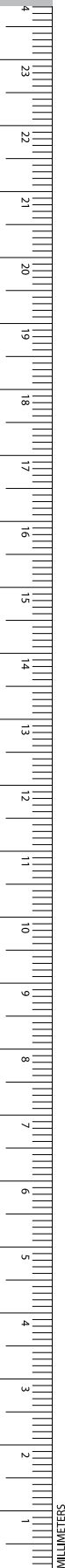
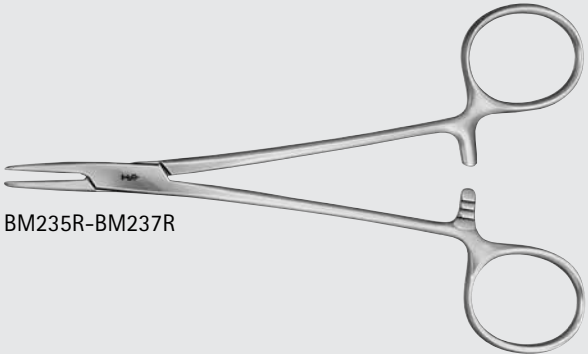
BM235R-BM237R



BM235R $\frac{1}{1}$



BM236R $\frac{1}{1}$



BM237R $\frac{1}{1}$

MAYO-HEGAR Needle Holder

Catalog Number	Jaw	Length (in.)
BM235R	X-SERR	6
BM236R	X-SERR	7 1/4
BM237R	X-SERR	7 7/8

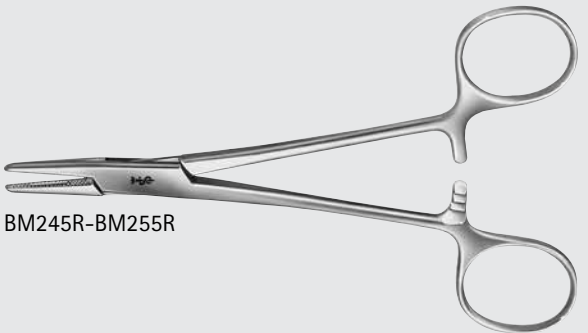

BM245R-BM255R



BM245R $\frac{1}{1}$



BM247R $\frac{1}{1}$



BM249R $\frac{1}{1}$



BM255R $\frac{1}{1}$

HEGAR Needle Holder

Catalog Number	Tip	Jaw	Length (in.)
BM245R	HEAVY	X-SERR	6
BM247R	HEAVY	X-SERR	6 7/8
BM249R	HEAVY	X-SERR	8
BM255R	HEAVY	X-SERR	8

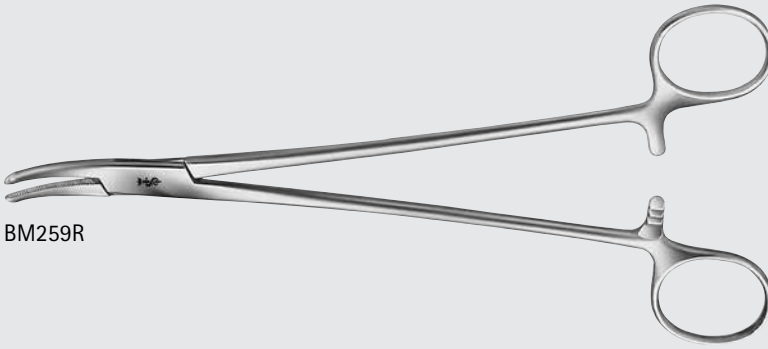

BM259R

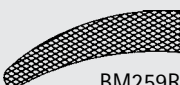

BM259R $\frac{1}{1}$

HEANEY Needle Holder

Catalog Number	Tip	Jaw	Length (in.)
BM259R	CVD	SERR	7 7/8



JAMESON Needle Holder

Catalog Number	Tip	Jaw	Length (in.)
BM270R	DEL	X-SERR	9

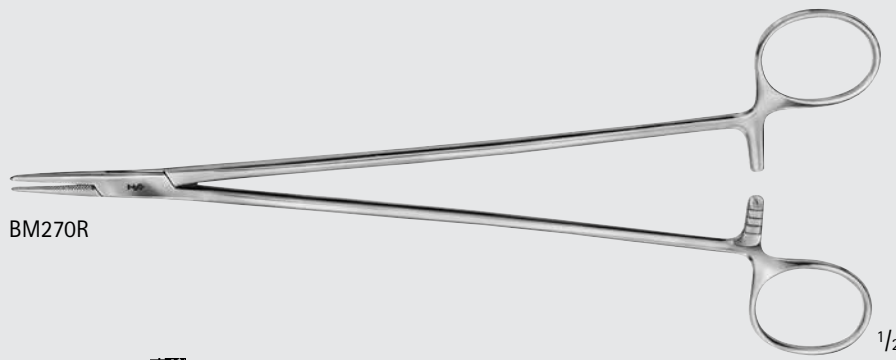

BM270R

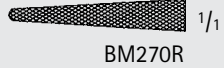

1/2

WANGENSTEEN Needle Holder

Catalog Number	Jaw	Length (in.)
BM272R	X-SERR	10 3/4

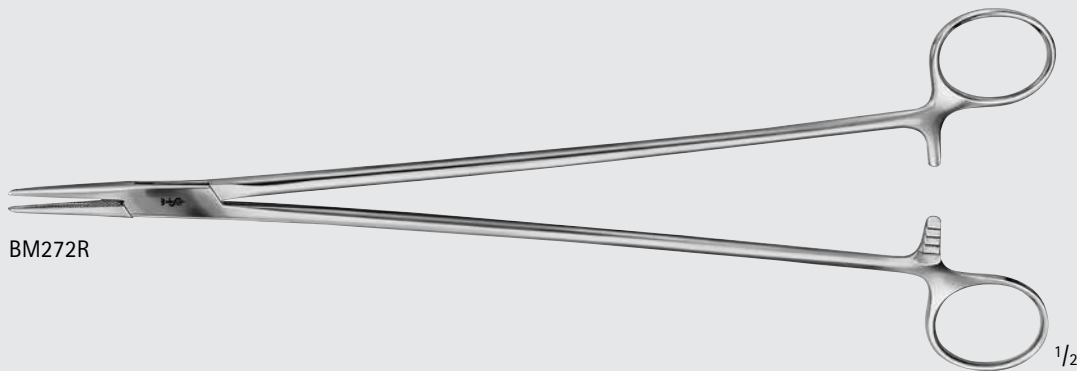

BM272R



1/2

MASSON Needle Holder

Catalog Number	Jaw	Length (in.)
BM275R	X-SERR	10 1/2

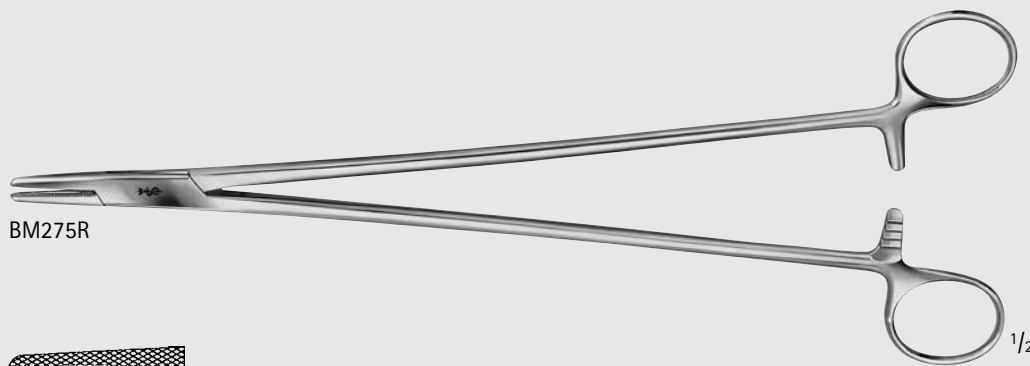

BM275R

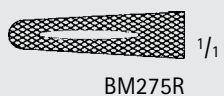

1/2

General Surgery

Needle Holders

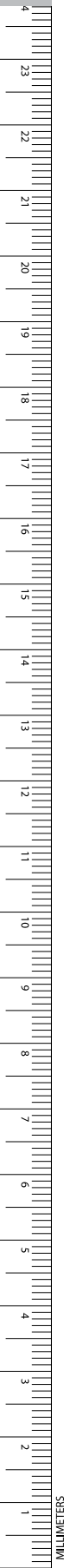

BM290R-BM291R

HEGAR-OLSEN Needle Holder/Scissors

Catalog Number	Jaw	Length (in.)
BM290R	SERR	5 1/2
BM291R	SERR	7 1/4

BM290R

BM291R

BM299R

GILLIES Needle Holder/Scissors

Catalog Number	Jaw	Length (in.)
BM299R	SERR	6 1/4

BM299R

General Surgery

DUROGRIP™ TC Needle Holders

Aesculap features Needle Holders with Tungsten Carbide (TC) inserts. A smooth jaw and three different serration patterns are available, depending on the size of the suture needle.

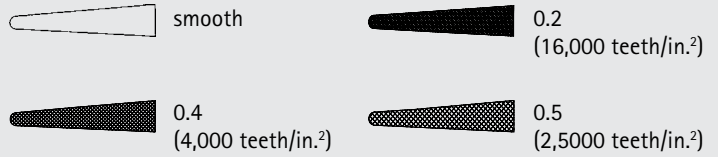
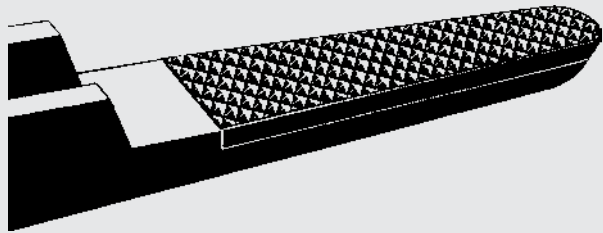

We recommend carbide inserts as follows:

Jaw Surface	Suture Material
Smooth	9/0 - 11/0
0.2 mm pitch of serration	6/0 - 10/0
0.4 mm pitch of serration	4/0 - 6/0
0.5 mm pitch of serration	up to 3/0



DUROGRIP TC HELLBERG-KUPKA Needle Holder W/ Ergonomic Handle

Catalog Number	Jaw	Length (in.)
BM320R	SERR	8 1/4

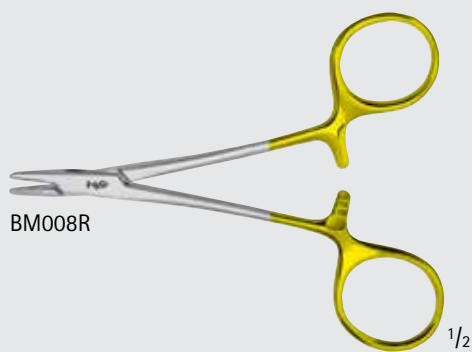
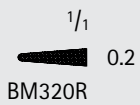

DUROGRIP TC DERF Needle Holder

Catalog Number	Jaw	Length (in.)
BM008R	SERR	4 3/4

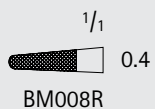

INCHES

General Surgery

DUROGRIP™ TC Needle Holders

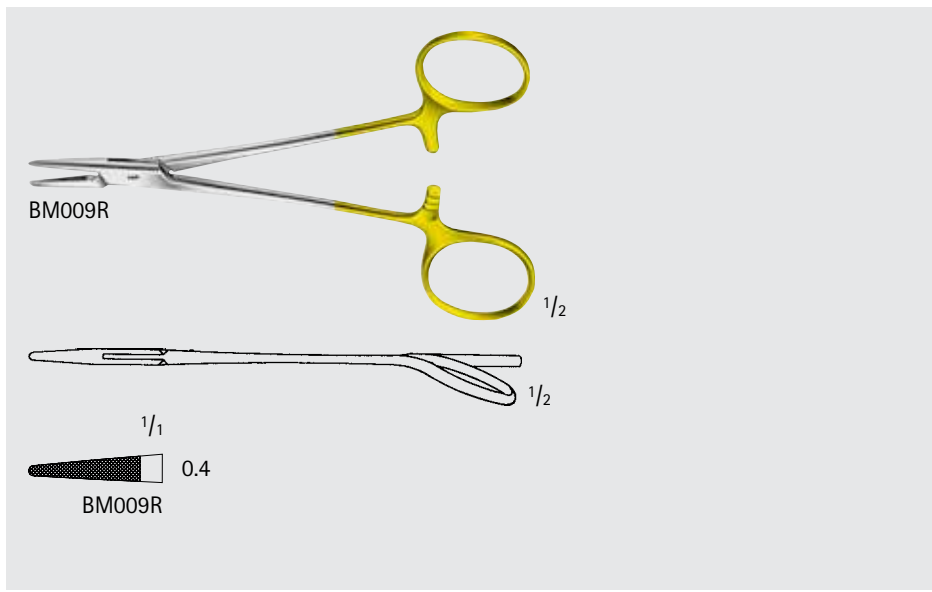

DUROGRIP TC MASING Needle Holder

Catalog Number	Jaw	Length (in.)
BM009R	SERR	5 1/8

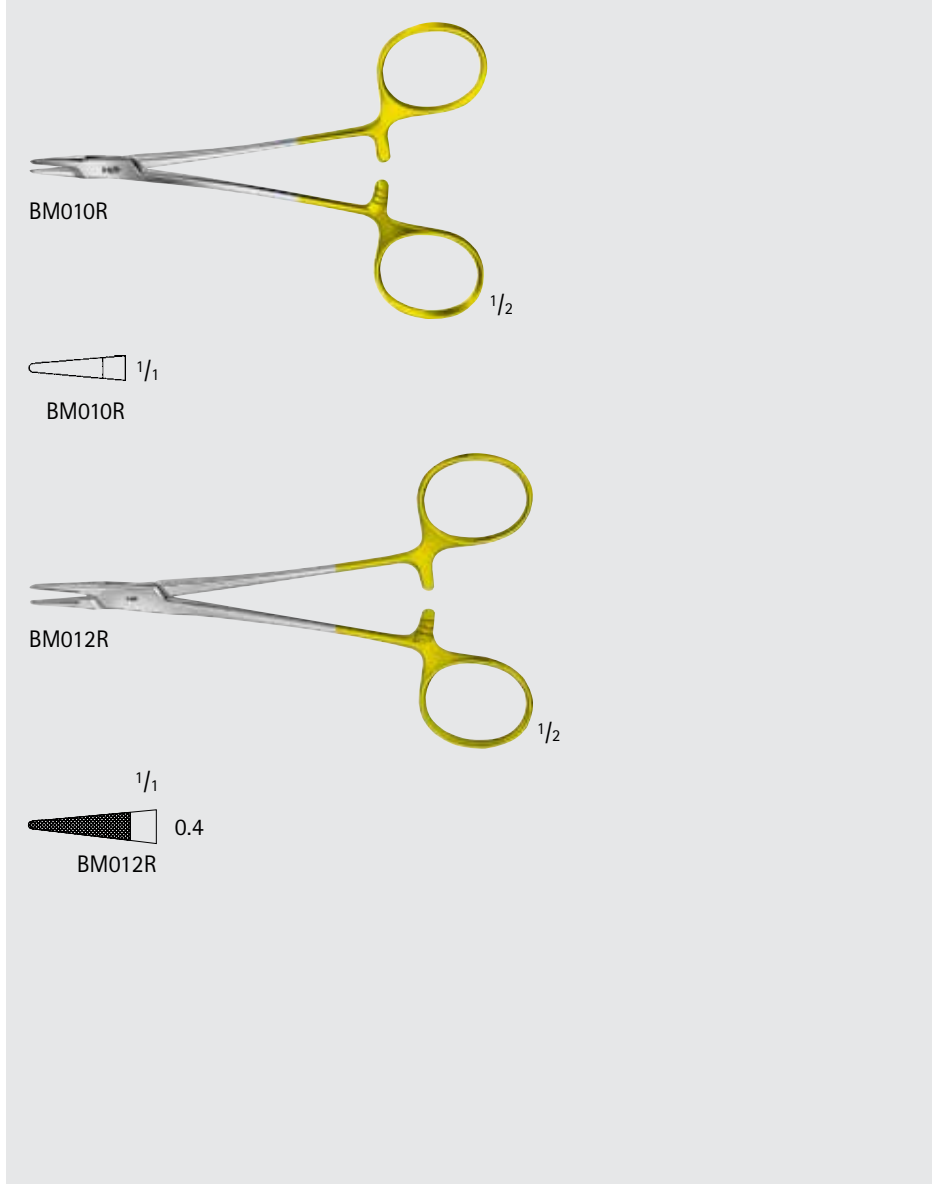

DUROGRIP TC HALSEY Needle Holder

Catalog Number	Jaw	Length (in.)
BM010R	SMOOTH	4 3/4
BM012R	SERR	5 1/8

DUROGRIP TC CONVERSE Needle Holder

Catalog Number	Jaw	Length (in.)
BM011R	SERR	5 1/8



BM011R

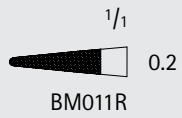

BM011R

DUROGRIP TC WEBSTER Needle Holder

Catalog Number	Jaw	Length (in.)
BM014R	SMOOTH	5 1/8
BM024R	SERR	5 1/8

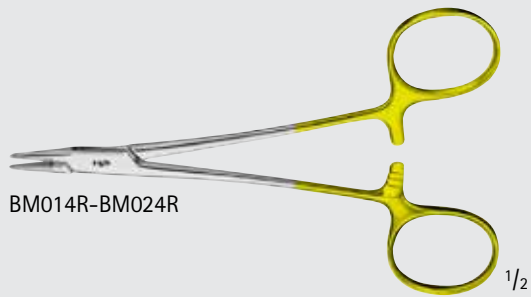

BM014R-BM024R



BM014R

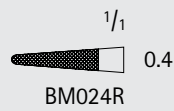

BM024R

DUROGRIP TC BAUMGARTNER Needle Holder

Catalog Number	Jaw	Length (in.)
BM015R	SERR	5 3/4

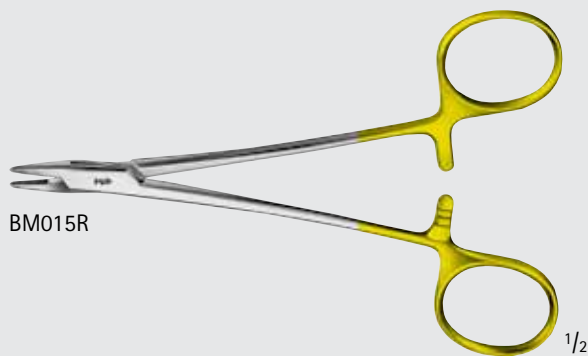

BM015R

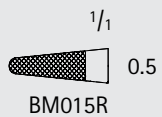

BM015R



INCHES

General Surgery

DUROGRIP™ TC Needle Holders

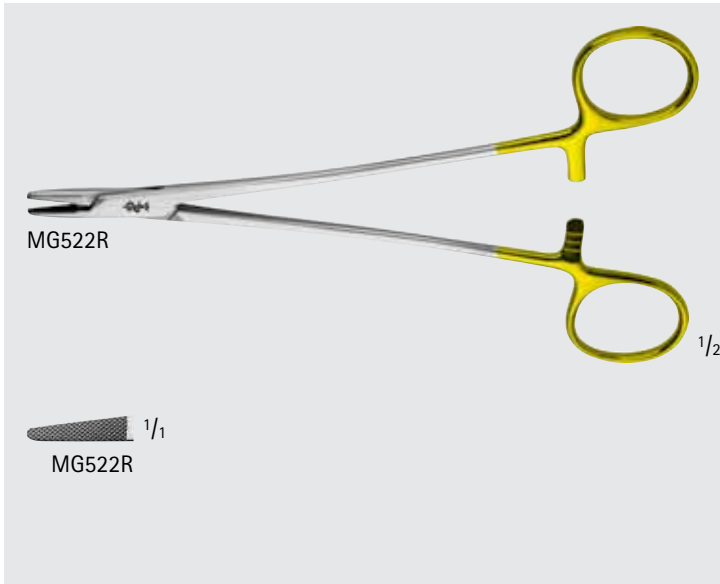

DUROGRIP TC NEW ORLEANS Needle Holder

Catalog Number	Jaw	Length (in.)
MG522R	SERR	7

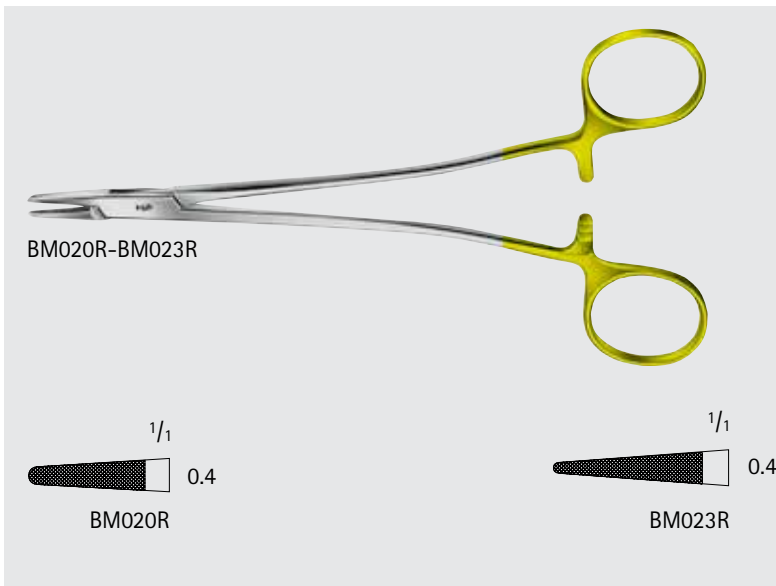

DUROGRIP TC SAROT Needle Holder

Catalog Number	Jaw	Length (in.)
BM020R	SERR	7
BM023R	SERR	10 1/4

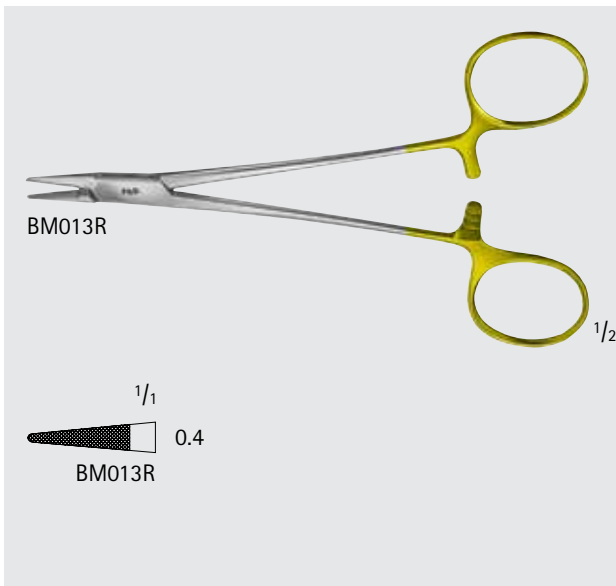

DUROGRIP TC Baby CRILE-WOOD Needle Holder

Catalog Number	Jaw	Length (in.)
BM013R	SERR	6

General Surgery

DUROGRIP™ TC Needle Holders

GENERAL SURGERY

DUROGRIP TC CRILE-WOOD Needle Holder

Catalog Number	Jaw	Length (in.)
BM016R	SERR	5 3/4
BM017R	SERR	7 1/4
BM019R	SERR	7 7/8
BM030R	SERR	10 5/8
BM021R	SERR	12
MB604R	SERR	14
BM029R	SMOOTH	6



BM016R, BM021R, MB604R

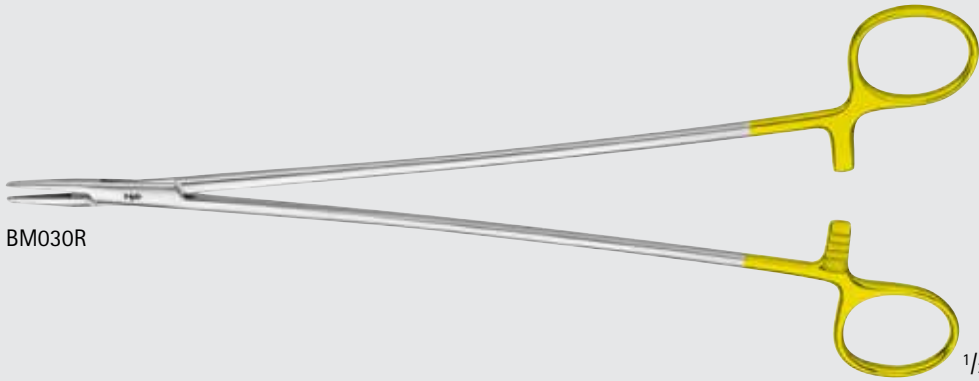
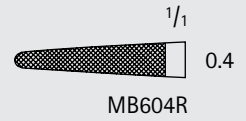
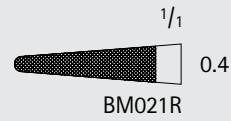
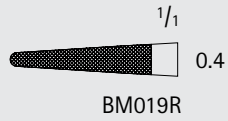
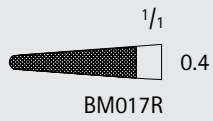
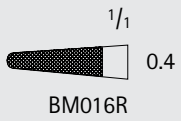

BM030R

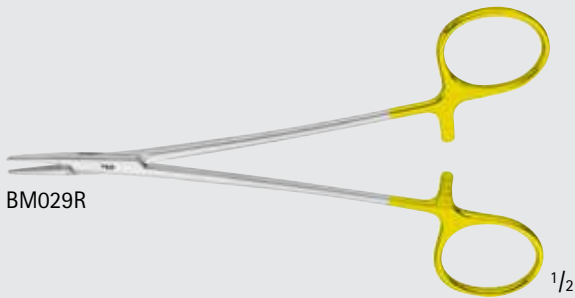
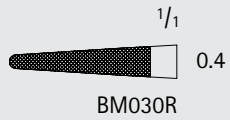

BM029R

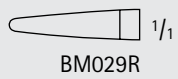

INCHES

General Surgery

DUROGRIP™ TC Needle Holders

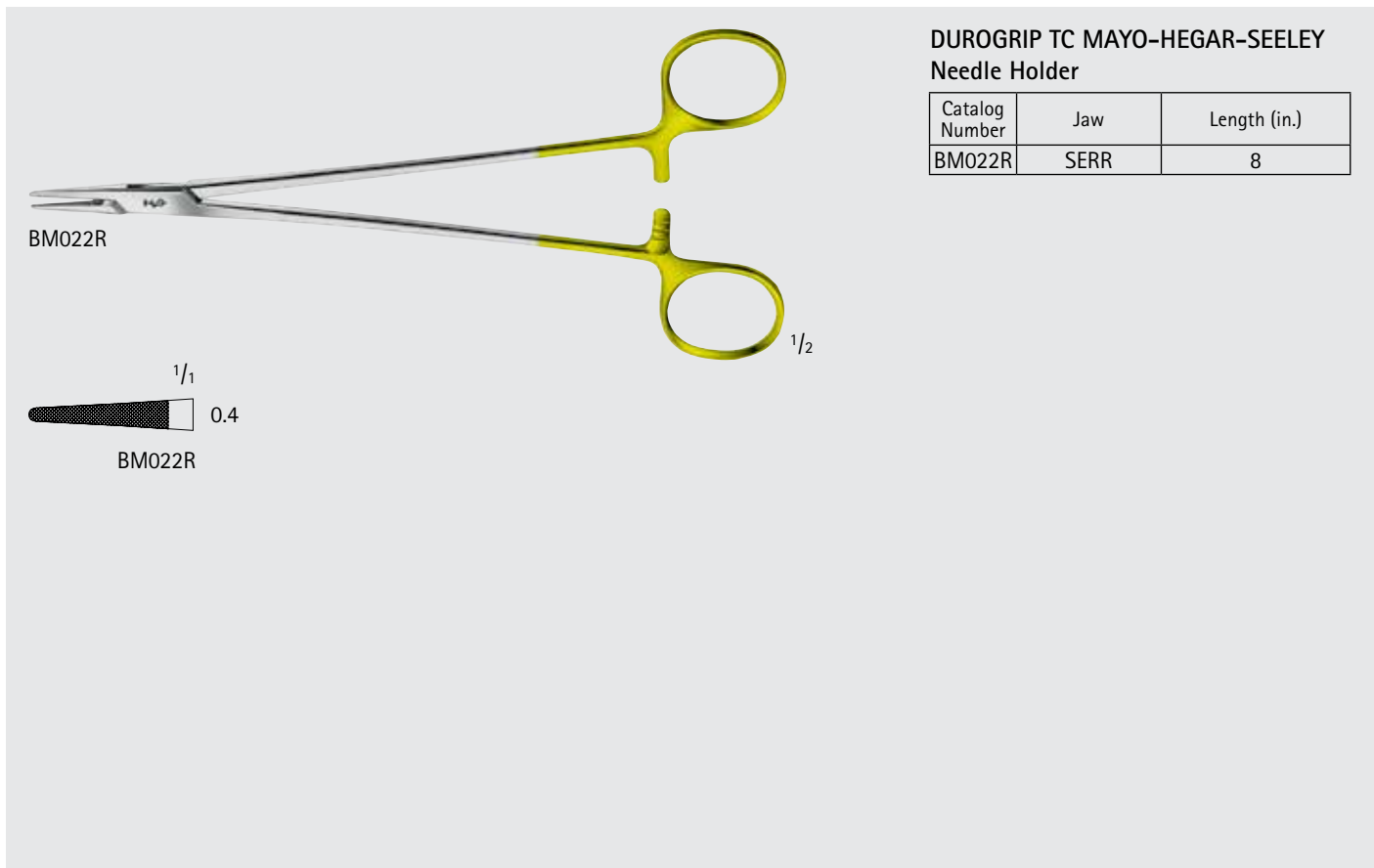

DUROGRIP TC MAYO-HEGAR-SEELEY Needle Holder

Catalog Number	Jaw	Length (in.)
BM022R	SERR	8

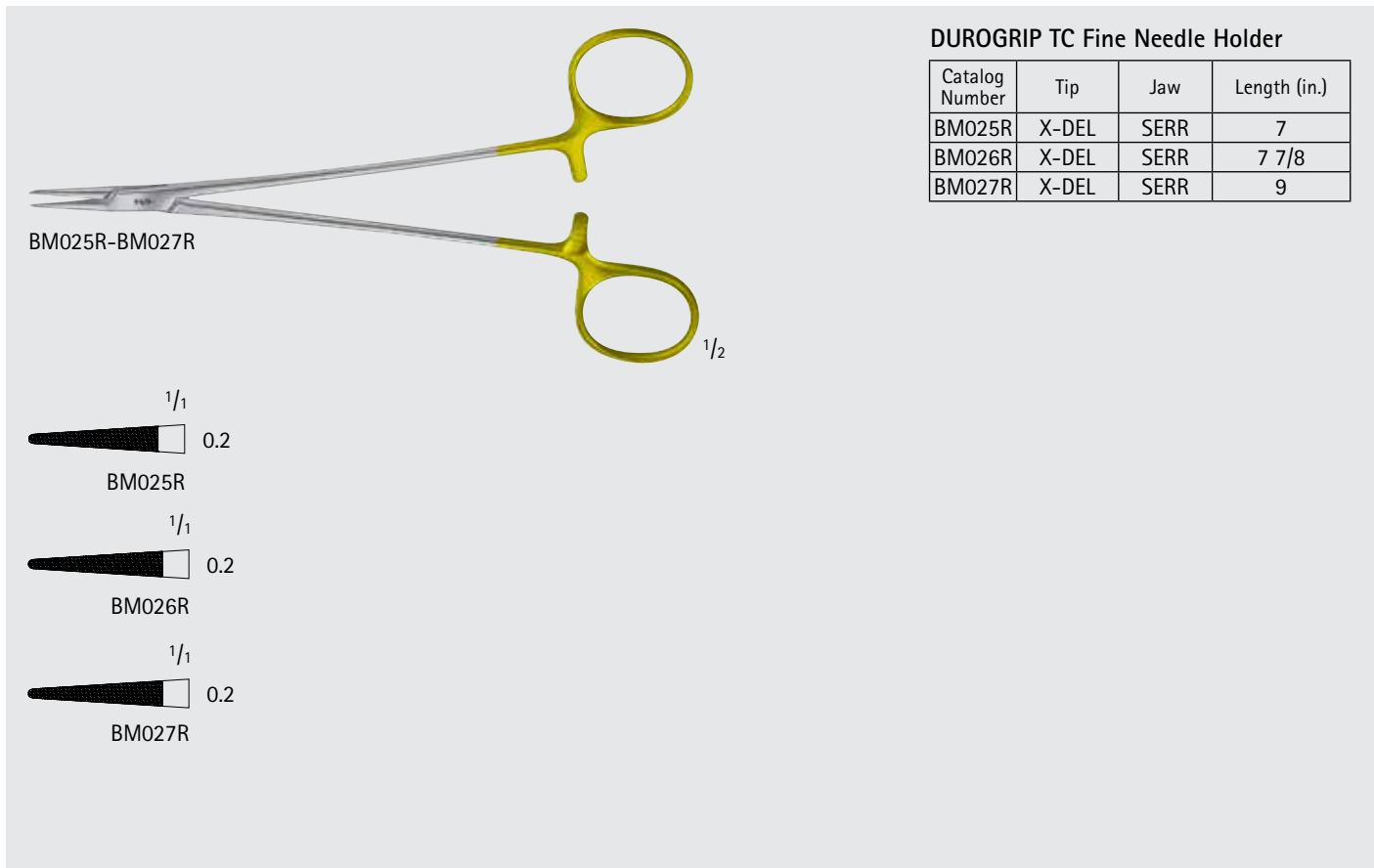

DUROGRIP TC Fine Needle Holder

Catalog Number	Tip	Jaw	Length (in.)
BM025R	X-DEL	SERR	7
BM026R	X-DEL	SERR	7 7/8
BM027R	X-DEL	SERR	9

DUROGRIP TC DEBAKEY Needle Holder

Catalog Number	Tip	Jaw	Length (in.)
BM032R	DEL	SERR	6
BM033R	DEL	SERR	6 1/2
BM035R	DEL	SERR	7
BM034R	DEL	SERR	8 1/4
BM036R	DEL	SERR	9
BM037R	DEL	SERR	10 1/4
BM038R	DEL	SERR	12
BM063R	X-DEL	SERR	6 1/2
BM064R	X-DEL	SERR	8 1/4
BM040R	X-DEL	SERR	12

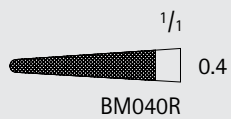
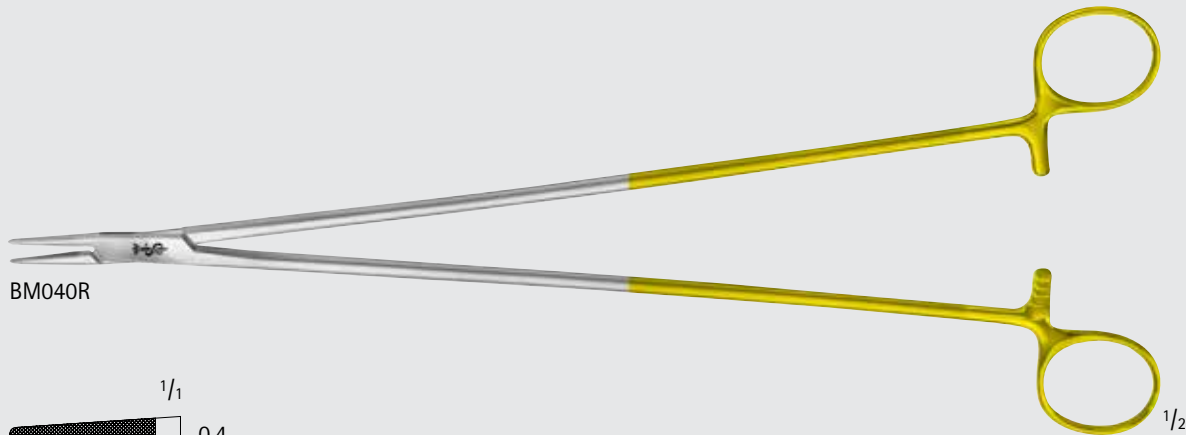
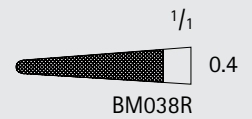
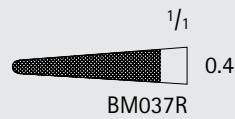
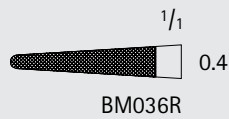
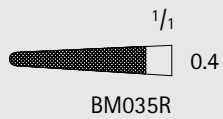
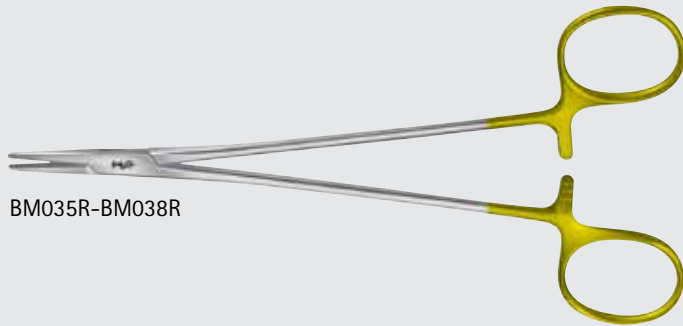
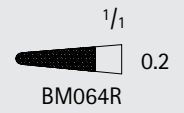
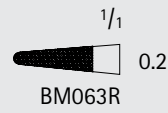
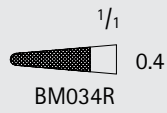
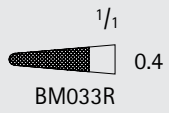
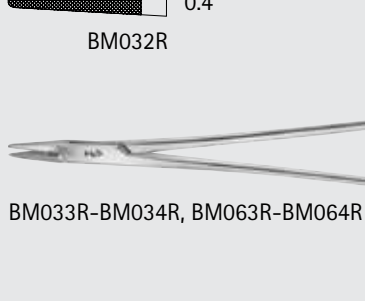
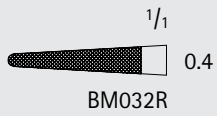
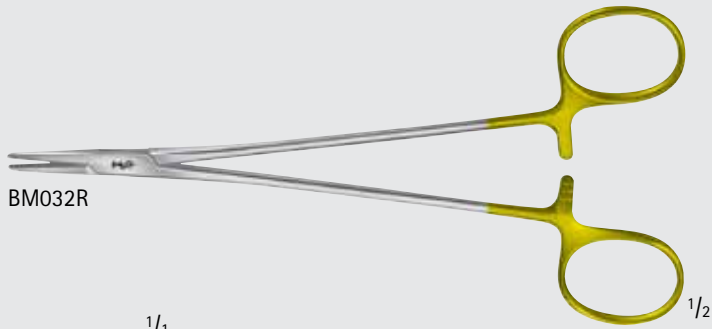

General Surgery

DUROGRIP™ TC Needle Holders

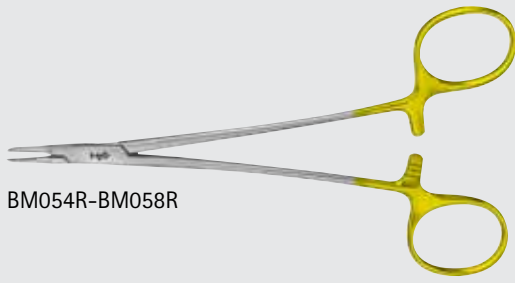

BM054R-BM058R

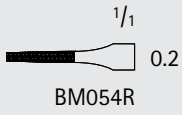

BM054R

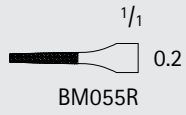

BM055R

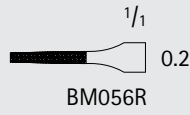

BM056R

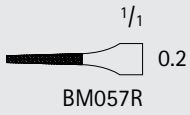

BM057R

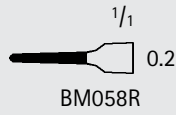

BM058R

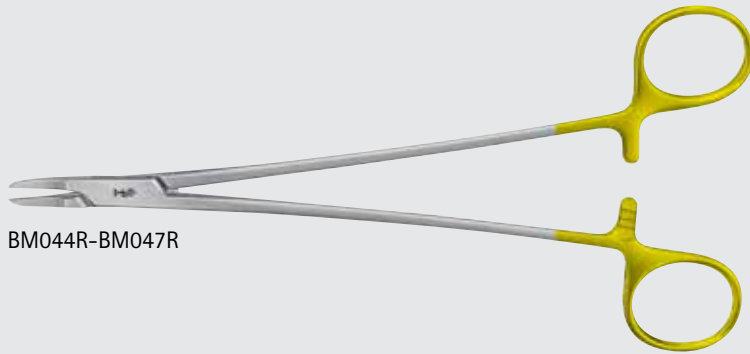

BM044R-BM047R

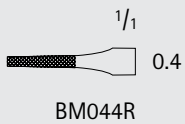

BM044R

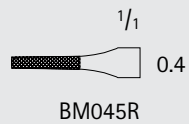

BM045R

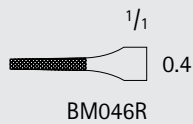

BM046R

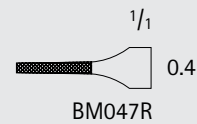

BM047R

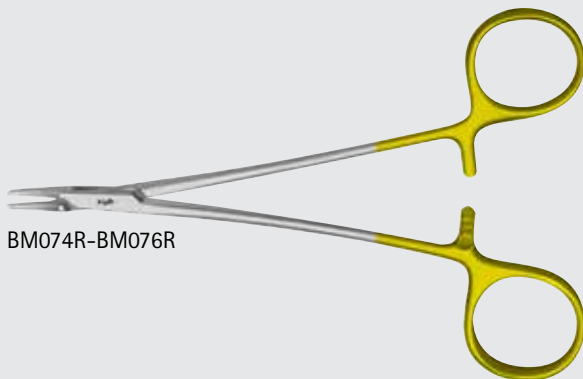

BM074R-BM076R

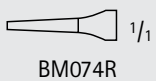

BM074R

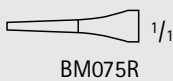

BM075R

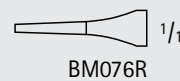

BM076R

DUROGRIP TC RYDER Needle Holder

Catalog Number	Tip	Jaw	Length (in.)
BM054R	X-DEL	SERR	5 1/4
BM055R	X-DEL	SERR	6 1/8
BM056R	X-DEL	SERR	6 7/8
BM057R	X-DEL	SERR	8 1/4
BM058R	X-DEL	SERR	9
BM044R	DEL	SERR	5 1/4
BM045R	DEL	SERR	6 7/8
BM046R	DEL	SERR	7 3/4
BM047R	DEL	SERR	10 1/2
BM074R	DEL	SMOOTH	6
BM075R	DEL	SMOOTH	7
BM076R	DEL	SMOOTH	8 7/8



DUROGRIP TC FRENCH Eye Needle Holder

Catalog Number	Jaw	Length (in.)
MB606R	SERR	6 1/4
MB607R	SERR	7 1/4
MB611R	SERR	8
MB612R	SERR	9 1/4

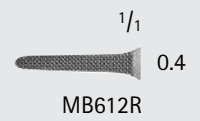
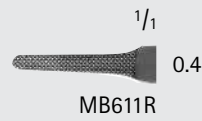
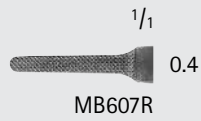
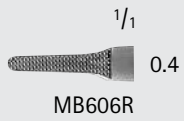
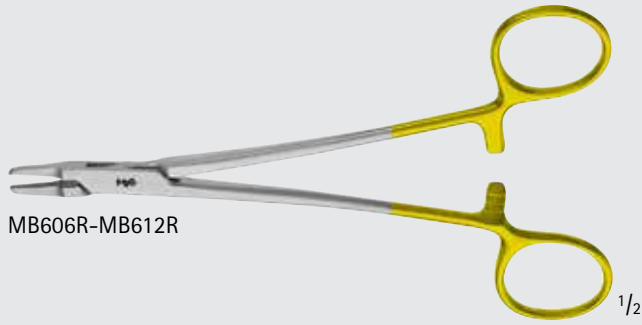

General Surgery

DUROGRIP™ TC Needle Holders

DUROGRIP TC MAYO-HEGAR Needle Holder

Catalog Number	Jaw	Length (in.)
BM065R	SERR	6
BM066R	SERR	7 1/4
BM067R	SERR	8
BM068R	SERR	9 1/4
BM070R	SERR	10 1/2
BM069R	SERR	12
MB617R	SERR	14



BM065R-BM070R

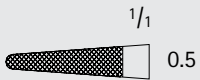

BM065R

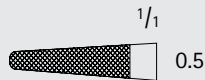

BM066R



BM067R



BM068R



BM070R

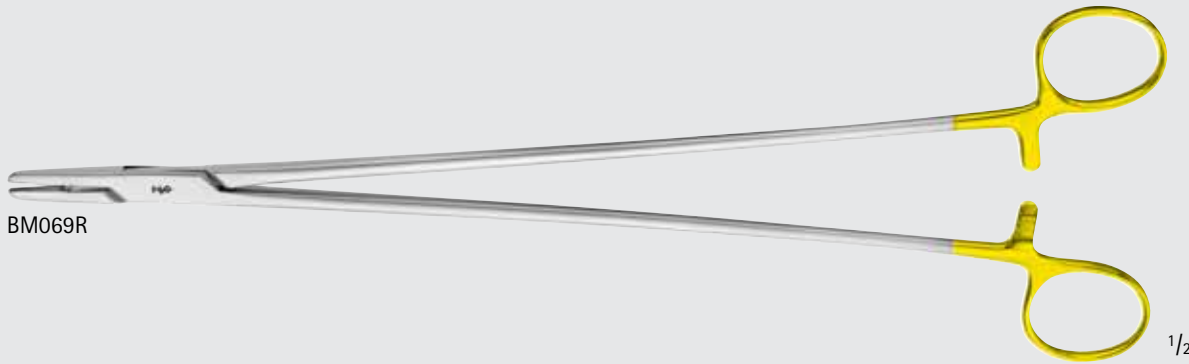

BM069R



BM069R

1/2

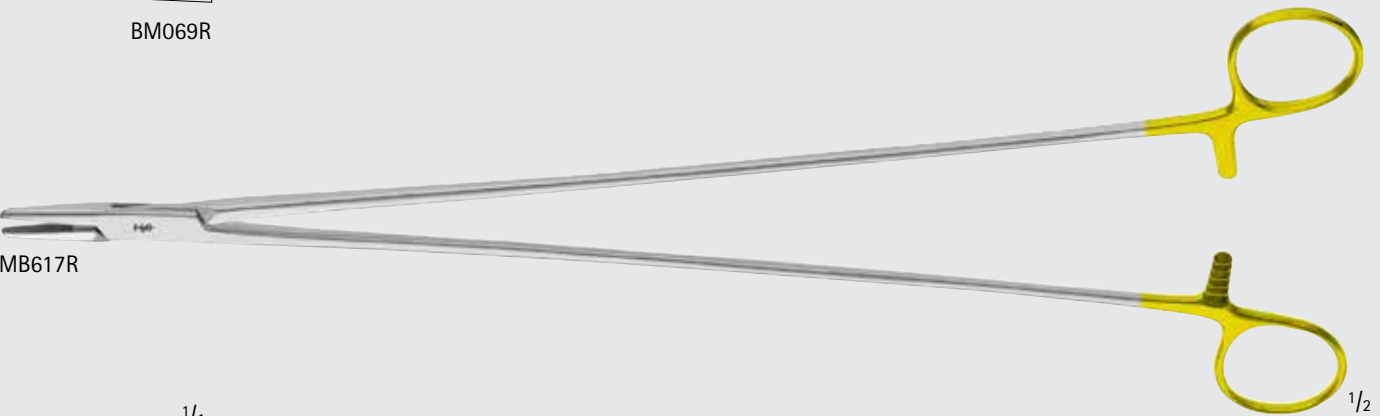

MB617R



MB617R

1/2

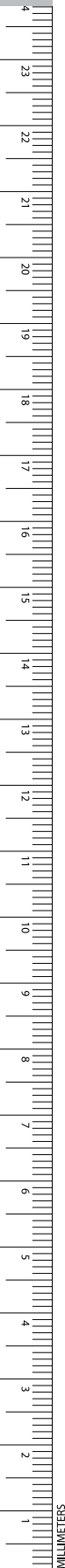

DUROGRIP TC HEGAR Needle Holder

Catalog Number	Tip	Jaw	Length (in.)
BM077R	HEAVY	SERR	8
BM078R	HEAVY	SERR	9 1/2

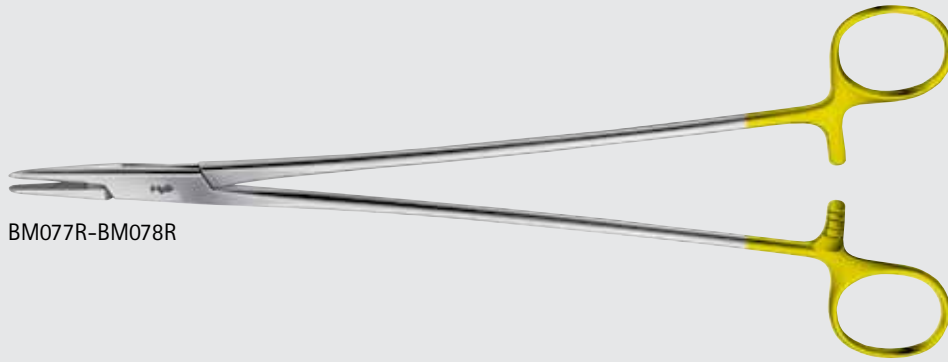

BM077R-BM078R

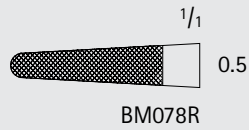
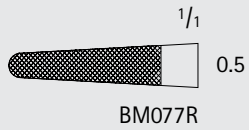

DUROGRIP TC WANGENSTEEN Needle Holder

Catalog Number	Jaw	Length (in.)
BM042R	SERR	10 3/4

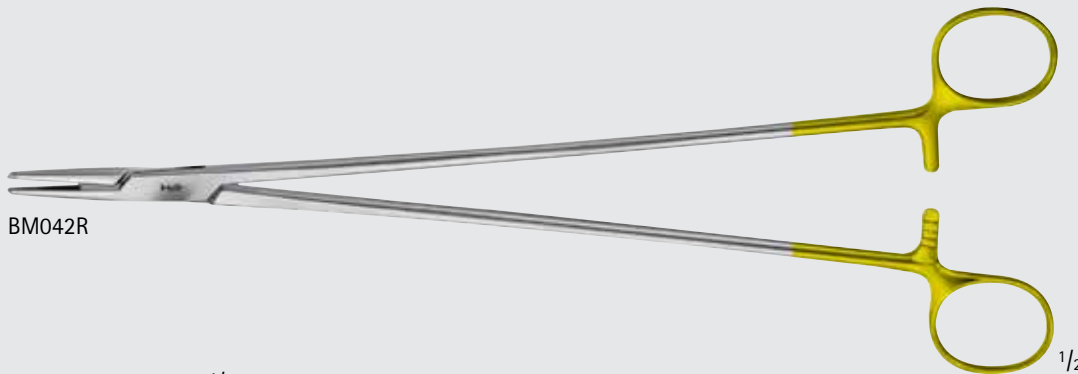

BM042R

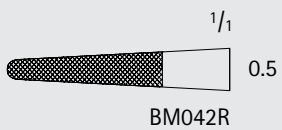

INCHES

General Surgery

DUROGRIP™ TC Needle Holders



DUROGRIP TC MASSON Needle Holder

Catalog Number	Jaw	Length (in.)
BM090R	SERR	10 1/2

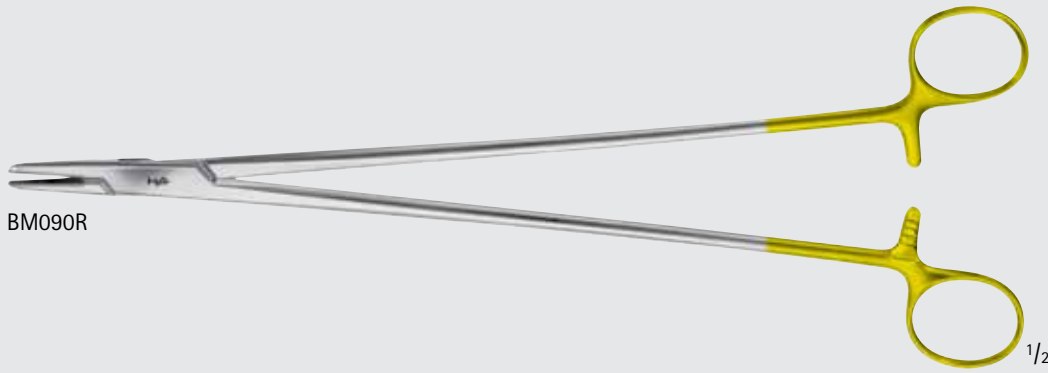

BM090R

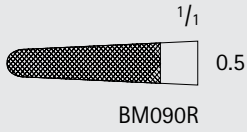

BM090R

DUROGRIP TC MAYO-MASSON Needle Holder

Catalog Number	Jaw	Length (in.)
MB918R	SERR	16

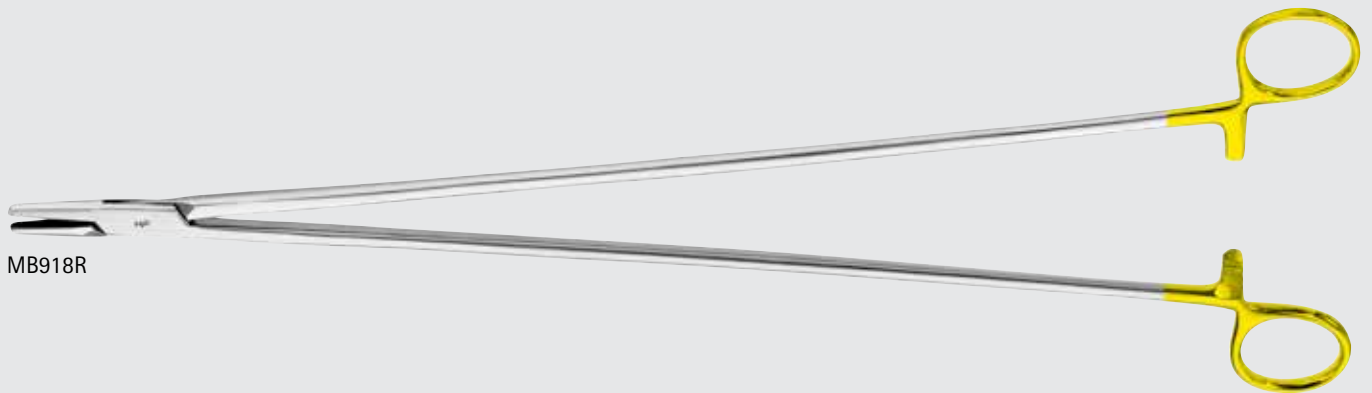

MB918R



MB918R

General Surgery

DUROGRIP™ TC Needle Holders

GENERAL SURGERY

DUROGRIP TC HEANEY Needle Holder

Catalog Number	Tip	Jaw	Length (in.)
BM081R	CVD	SERR	7 7/8
BM084R	CVD	SERR	10 1/4

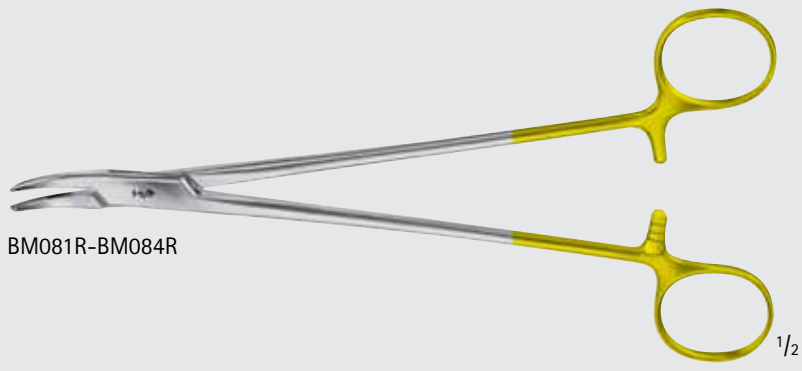

BM081R-BM084R

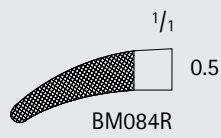
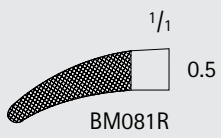

DUROGRIP TC MUELLER Needle Holder

Catalog Number	Tip	Jaw	Length (in.)
BM089R	CVD	SERR	14 1/4

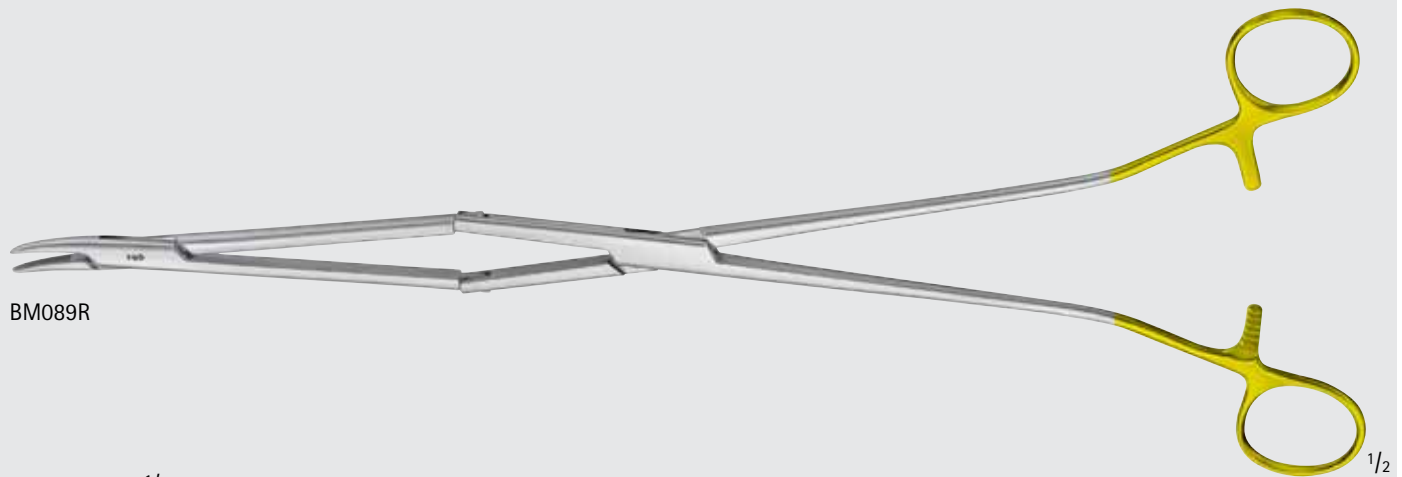

BM089R

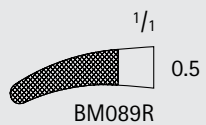

INCHES

General Surgery

DUROGRIP™ TC Needle Holders



DUROGRIP TC FINOCHIETTO Needle Holder

Catalog Number	Tip	Jaw	Length (in.)
BM092R	ANG	SERR	10 1/2

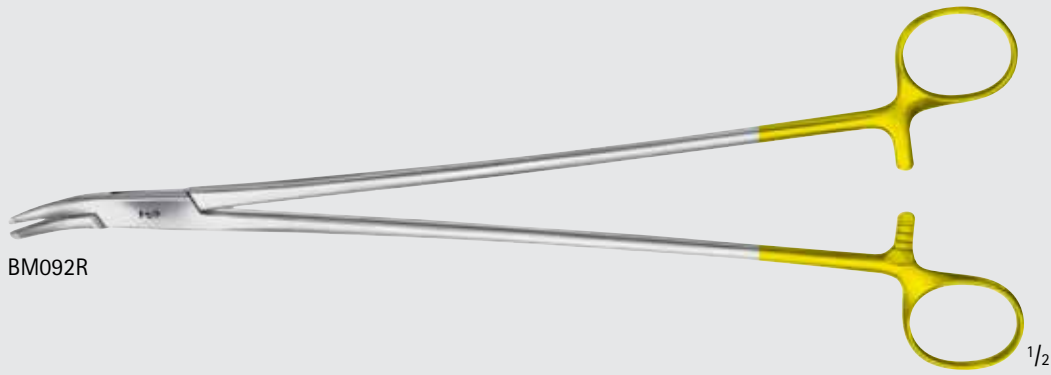

BM092R

1/2

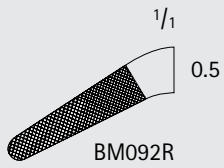

BM092R

DUROGRIP TC STRATTE Needle Holder

Catalog Number	Tip	Jaw	Length (in.)
BM095R	CVD	SERR	8 1/4
BM096R	CVD	SERR	9

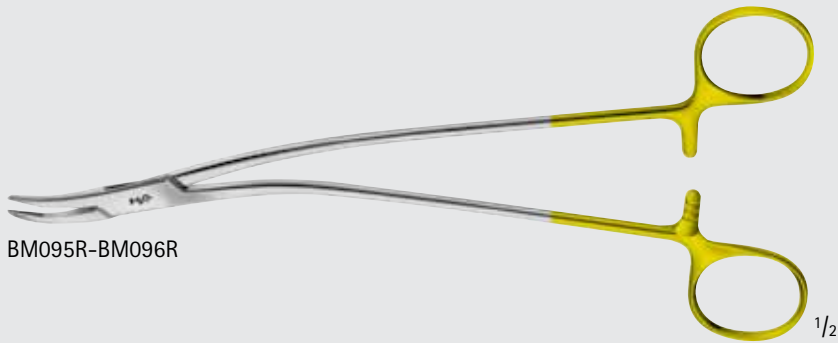

BM095R-BM096R

1/2

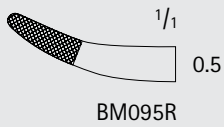

BM095R

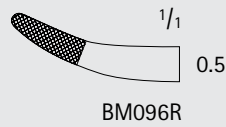

BM096R

DUROGRIP TC Wire Twister

Catalog Number	Tip	Jaw	Length (in.)
BM110R	ROUND	SERR	6 1/8
BM111R	SQUARE	SERR	6

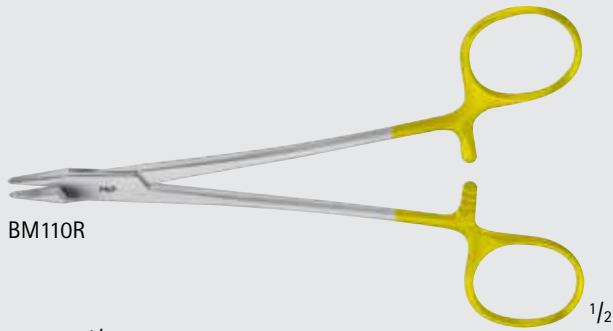

BM110R

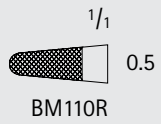

BM111R

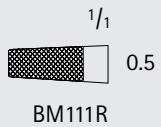

DUROGRIP TC BAUMGARTNER Wire Twister

Catalog Number	Tip	Jaw	Length (in.)
BM112R	SQUARE	SERR	7 7/8

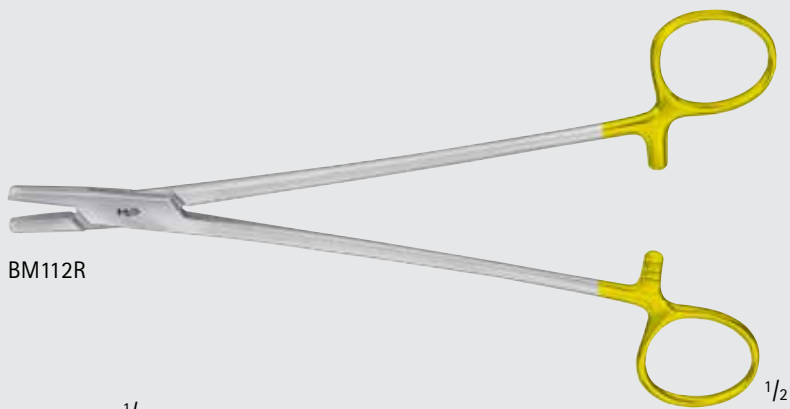

BM112R

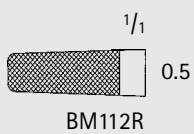

INCHES

General Surgery

DUROGRIP™ TC Needle Holders

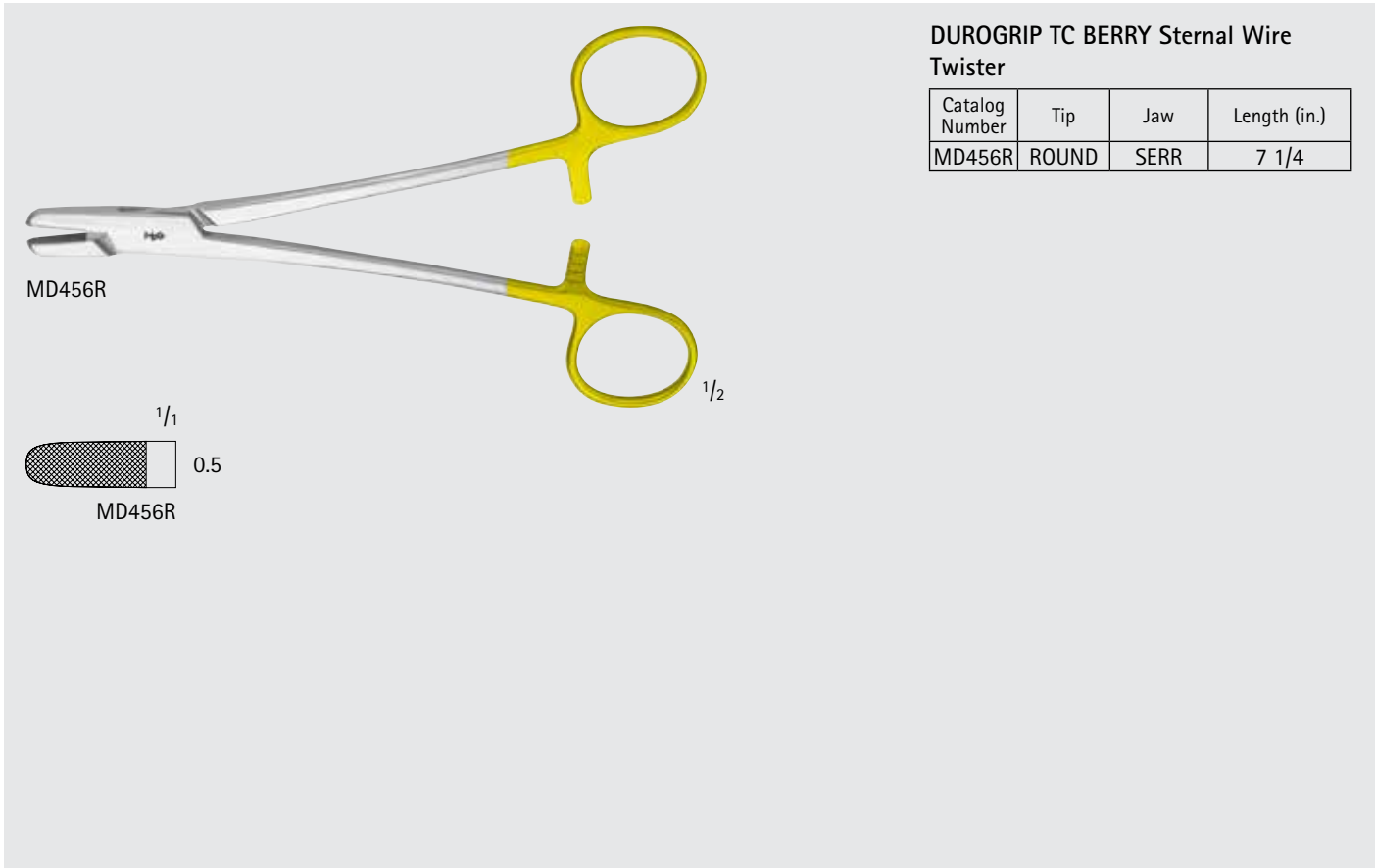

DUROGRIP TC BERRY Sternal Wire Twister

Catalog Number	Tip	Jaw	Length (in.)
MD456R	ROUND	SERR	7 1/4

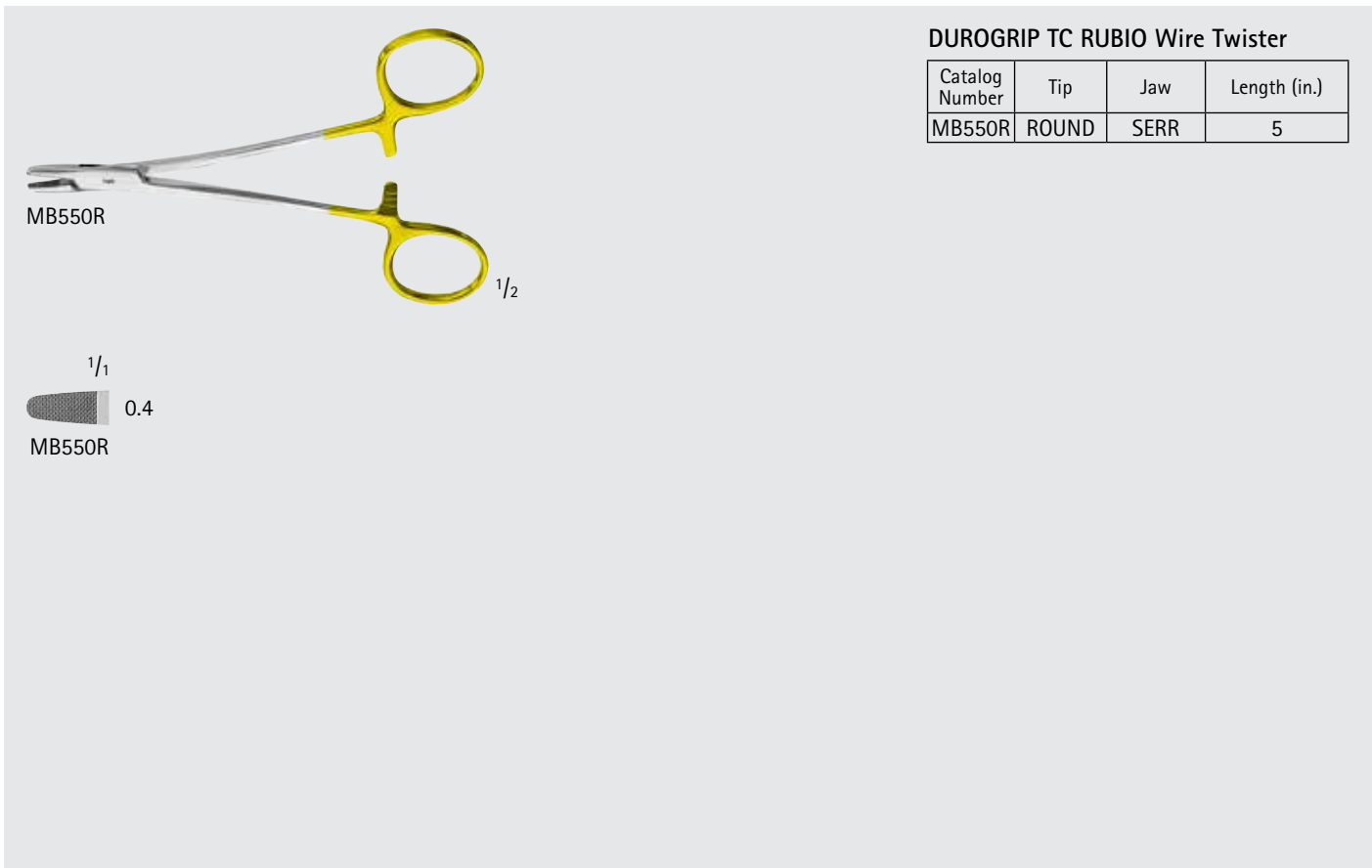

DUROGRIP TC RUBIO Wire Twister

Catalog Number	Tip	Jaw	Length (in.)
MB550R	ROUND	SERR	5

General Surgery

DUROGRIP™ TC Needle Holders

DUROGRIP TC MATHIEU Needle Holder

Catalog Number	Jaw	Length (in.)
BM149R	SERR	5 1/2
BM151R	SERR	6 1/2
BM154R	SERR	7 7/8



BM149R-BM154R

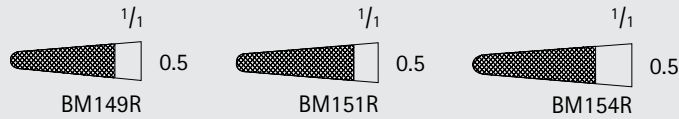

DUROGRIP TC MATHIEU Needle Holder, Heavy

Catalog Number	Jaw	Length (in.)
BM156R	SERR	7 7/8
BM158R	SERR	9 5/8

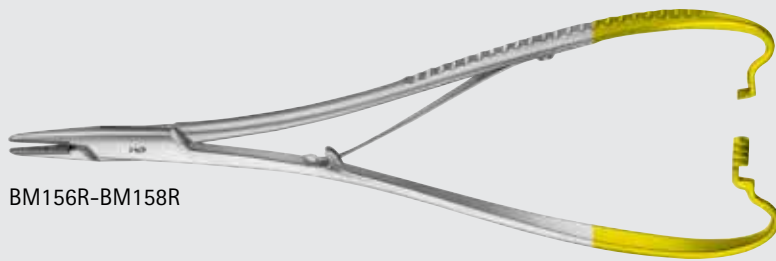

BM156R-BM158R



General Surgery

Needle Cases



BL907R

Needle Case, Rectangle

Catalog Number	Dimensions (mm)
BL907R	70 x 53 x 9



BL930R-BL933R



BL931R-BL933R

Needle Case, Round

Catalog Number	Item	Dimensions (mm)
BL930R	COMPLETE NEEDLE CASE W/ INTERIOR BOX	65 x 16
BL931R	INTERIOR BOX ONLY	62 x 12
BL933R	INTERIOR BOX ONLY	90 x 12



BL941R

Needle Case, With 7 Sections

Catalog Number	Dimensions (mm)
BL941R	150 x 90 x 10





BM822R-BM824R

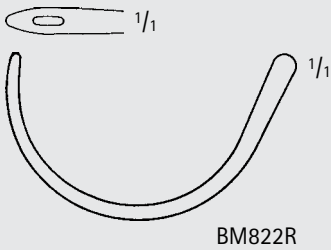

BM822R

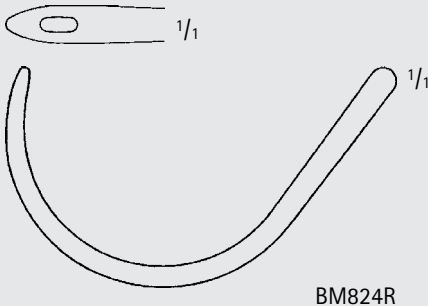

BM824R



BM749R, BM781R, BM807R, BM809R, BM811R, BM813R



BM781R

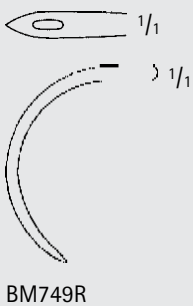

BM749R

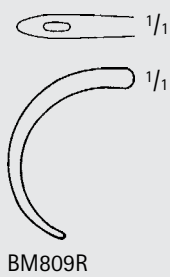

BM809R

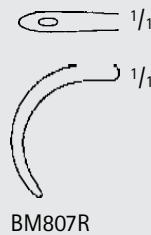

BM807R



BM811R

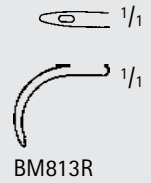

BM813R

DESCHAMPS Needle

Catalog Number	Hand Orientation	Tip	Length (in.)
BM822R	RIGHT	BLUNT, 3.5 MM	9 1/2
BM824R	RIGHT	BLUNT, 5 MM	11
BM781R	LEFT	SHARP, 2 MM	8 1/4
BM749R	LEFT	SHARP, 3.5 MM	8 1/2
BM809R	LEFT	BLUNT, 2.5 MM	8 1/4
BM807R	LEFT	BLUNT, 2.5 MM	8 1/2
BM811R	LEFT	BLUNT, 3.5 MM	8 1/2
BM813R	LEFT	STEEP, BLUNT, 2 MM	8 7/8



INCHES

General Surgery

Ligature Needles



BM770R

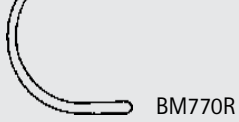
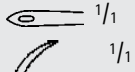

BM770R



BM771R

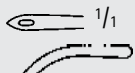

BM771R

HURD Needle

Catalog Number	Hand Orientation	Tip	Length (in.)
BM770R	RIGHT	SHARP	8 1/4
BM771R	LEFT	SHARP	8 1/4

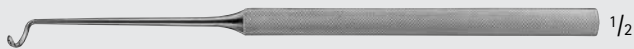

BM801R

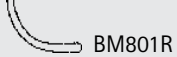

BM801R

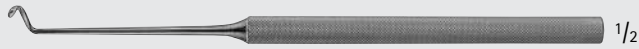

BM802R

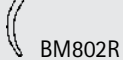

BM802R

KRONECKER Needle

Catalog Number	Hand Orientation	Tip	Length (in.)
BM801R	RIGHT	BLUNT	6 1/8
BM802R	LEFT	BLUNT	6 1/8



BM855R

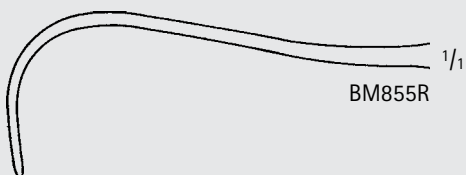

BM855R

SYME Suture Needle

Catalog Number	Tip	Length (in.)
BM855R	BLUNT	6 3/4

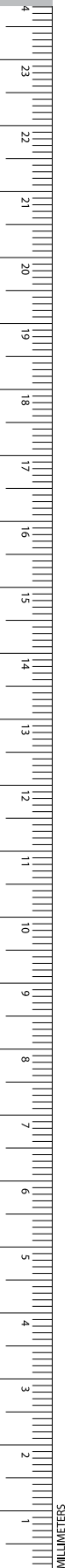

Monopolar Diathermi Forceps, Insulated

Catalog Number	Length (in.)
GK033R	13 3/4

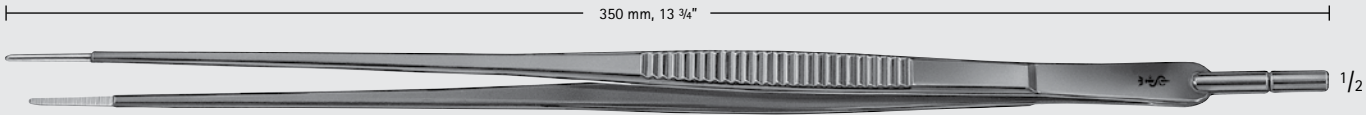

GK033R



GK033R

Dressing Forceps, Standard Patterns

Catalog Number	Tip	Length (in.)
BD043R	SERR	4 1/2
BD045R	SERR	5 1/8
BD047R	SERR	5 3/4
BD049R	SERR	6 1/4
BD050R	SERR	7
BD051R	SERR	7 7/8
BD052R	SERR	9 3/4
BD053R	SERR	11 3/4



BD043R-BD053R

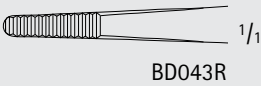

BD043R

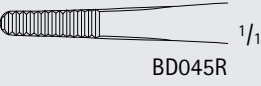

BD045R

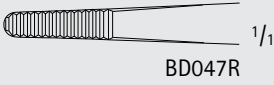

BD047R

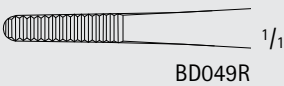

BD049R

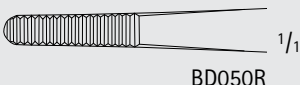

BD050R

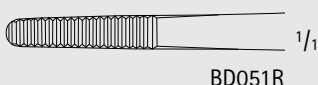

BD051R

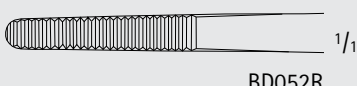

BD052R

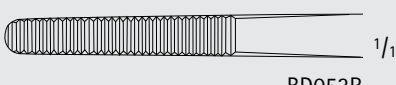

BD053R

Dressing Forceps, Extra Wide

Catalog Number	Tip	Length (in.)
BD077R	SERR	5 3/4



BD077R

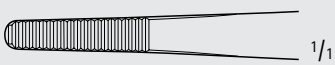

BD077R



INCHES

General Surgery

Dressing and Tissue Forceps



BD023R-BD033R

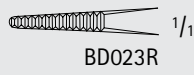

BD023R

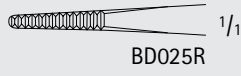

BD025R



BD027R



BD029R

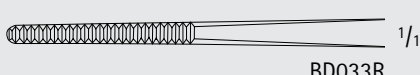

BD033R



BD035R-BD037R



BD035R

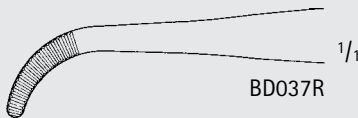

BD037R

Dressing Forceps, Delicate

Catalog Number	Tip	Length (in.)
BD023R	STR, SERR	4 1/2
BD025R	STR, SERR	5 1/8
BD027R	STR, SERR	5 3/4
BD029R	STR, SERR	6 1/4
BD033R	STR, SERR	12
BD035R	CVD, SERR	5 1/8
BD037R	CVD, SERR	5 1/2



BD210R

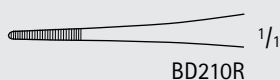

BD210R

Dressing Forceps, Extra Delicate

Catalog Number	Tip	Length (in.)
BD210R	SERR	4 1/2

Tissue Forceps, Delicate

Catalog Number	Tip	Teeth	Length (in.)
BD533R	STR	1 x 2	4 1/2
BD535R	STR	1 x 2	5 1/8
BD537R	STR	1 x 2	5 3/4
BD539R	STR	1 x 2	6 1/4
BD540R	STR	1 x 2	7
BD541R	STR	1 x 2	7 7/8
BD542R	STR	1 x 2	9 3/4
BD543R	STR	1 x 2	11 3/4
MB803R	STR	2 x 3	4 1/2
BD575R	STR	2 x 3	5 1/8
BD577R	STR	2 x 3	5 3/4
BD579R	STR	2 x 3	6 1/4
BD580R	STR	2 x 3	7
BD581R	STR	2 x 3	7 7/8
BD587R	STR	3 x 4	5 3/4
BD589R	STR	3 x 4	6 1/4
BD591R	STR	3 x 4	7 7/8
BD527R	CVD	1 x 2	5 3/4

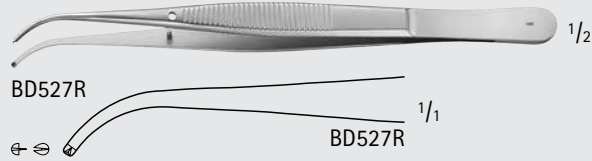
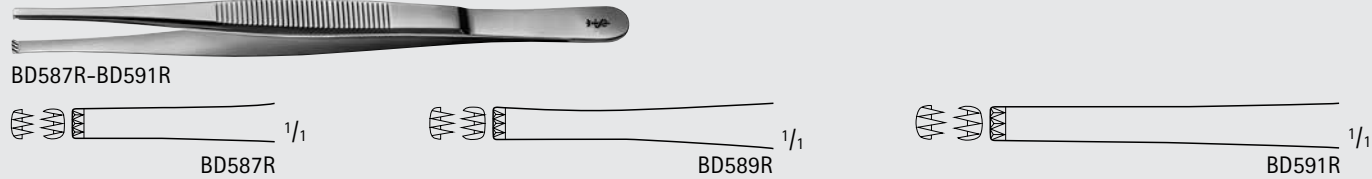
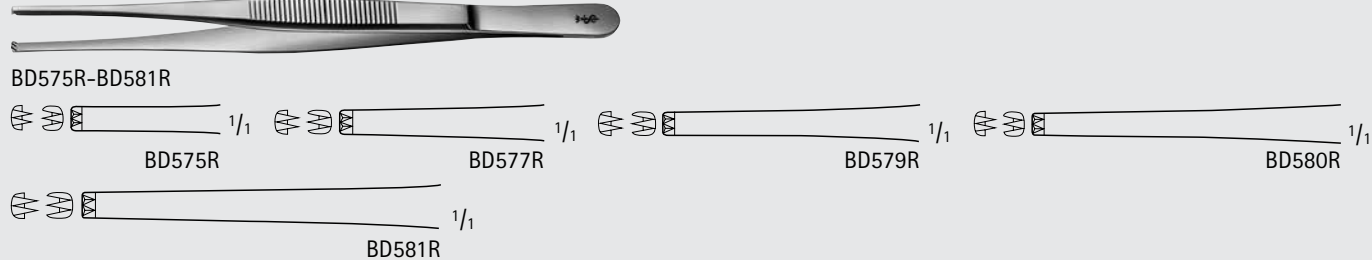
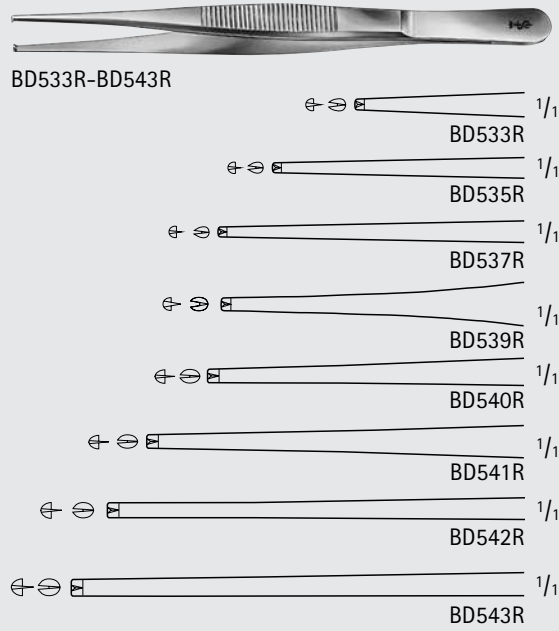

Tissue Forceps, Medium

Catalog Number	Teeth	Length (in.)
BD547R	1 x 2	5 3/4
BD549R	1 x 2	6 1/4

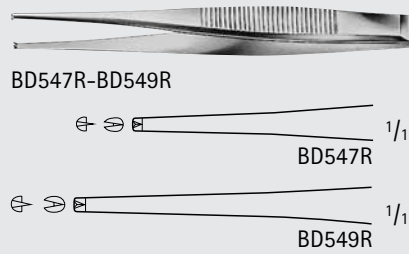

INCHES

General Surgery

Dressing and Tissue Forceps



BD553R-BD563R

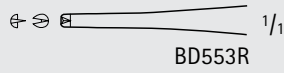

BD553R

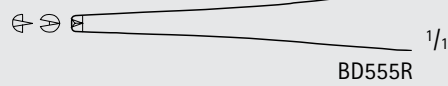

BD555R

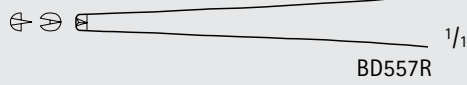

BD557R



BD559R

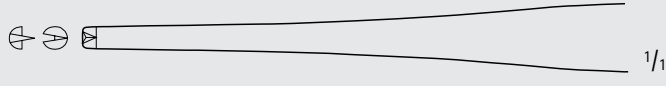

BD560R

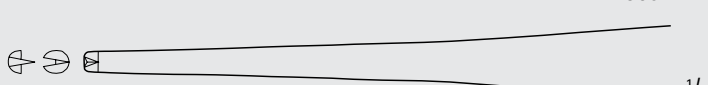

BD561R



BD562R

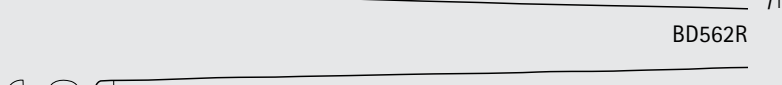

BD563R

Tissue Forceps, Standard Patterns

Catalog Number	Teeth	Length (in.)
BD553R	1 x 2	4 1/2
BD555R	1 x 2	5 1/8
BD557R	1 x 2	5 3/4
BD559R	1 x 2	6 1/4
BD560R	1 x 2	7
BD561R	1 x 2	7 7/8
BD562R	1 x 2	9 3/4
BD563R	1 x 2	11 3/4

General Surgery

Dressing and Tissue Forceps



BD690R-BD692R

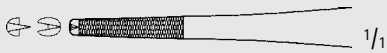

BD690R

1/1

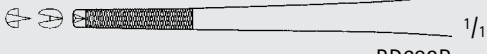

BD692R

1/1

STRASSBURGER Tissue Forceps

Catalog Number	Tip	Teeth	Length (in.)
BD690R	X-SERR	1 x 2	6
BD692R	X-SERR	1 x 2	7 7/8

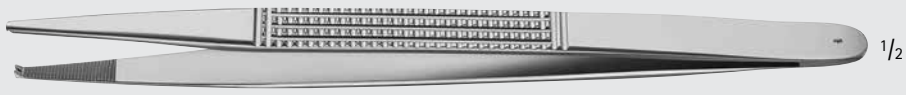

MG077R

1/2



MG077R

1/1

CURTIS Tissue Forceps

Catalog Number	Tip	Length (in.)
MG077R	SERR	8 3/4



BD693R

1/2



BD693R

1/1



MG357R

1/2



MG357R

1/1

BONNEY Tissue Forceps

Catalog Number	Tip	Teeth	Length (in.)
BD693R	SERR	1 x 2	6 7/8
MG357R	SERR	2 x 3	6 3/4



BD733R

1/2

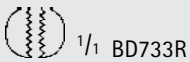

BD733R

1/1

MARTIN Tissue Forceps

Catalog Number	Teeth	Length (in.)
BD733R	7 x 8	6 1/8

General Surgery

Dressing and Tissue Forceps



MB224



MB224



MG464R-MG465R



MG464R



MG465R

HEANEY Tissue Forceps

Catalog Number	Tip	Teeth	Length (in.)
MG464R	X-SERR	1 x 2	7 1/4
MB224	X-SERR	2 x 3	5 1/2
MG465R	X-SERR	3 x 4	7 1/2



BD725R-BD727R

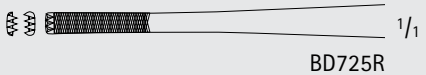

BD725R

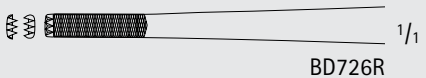

BD726R

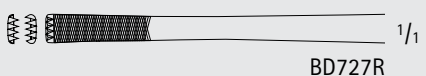

BD727R

STILLE-BARRAYA CV Forceps

Catalog Number	Tip	Teeth	Length (in.)
BD725R	X-SERR	3 x 4	7
BD726R	X-SERR	3 x 4	7 7/8
BD727R	X-SERR	3 x 4	9 3/4



BD755R



BD755R



BD760R-BD761R, MB921R-MB922R, XG006R



BD760R



BD761R, MB921R, MB922R

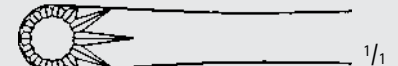

XG006R

RUSSIAN Tissue Forceps

Catalog Number	Length (in.)
BD755R	6
BD760R	7 7/8
XG006R	9 3/4
BD761R	10 1/4
MB921R	12
MB922R	14



MB208R-MB923R



MAYO-RUSSIAN Tissue Forceps

Catalog Number	Tip	Length (in.)
MB208R	FENESTRATED	9
MB923R	FENESTRATED	14



BD750R

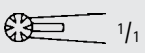

BD750R



MB795R



MB795R

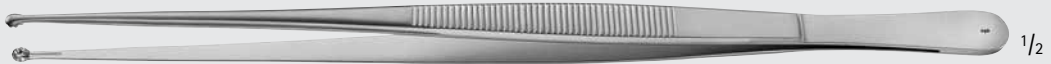

MG078R



MG078R

SELMAN Tissue Forceps

Catalog Number	Length (in.)
BD750R	6 1/8
MB795R	7 7/8
MG078R	9 3/4

General Surgery

Dressing and Tissue Forceps

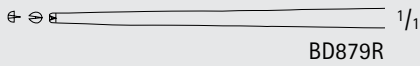
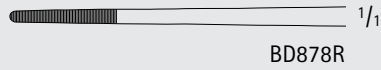

LUCAE Bayonet Forceps

Catalog Number	Tip	Teeth	Length (in.)
BD878R	SERR	-	5 1/2
BD879R	SMOOTH	1 x 2	5 1/2

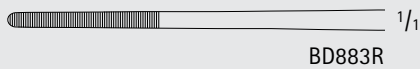

GRUENWALD Bayonet Forceps

Catalog Number	Tip	Length (in.)
BD883R	SERR	7 7/8

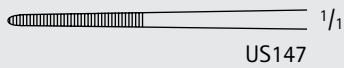

CUSHING Bayonet Forceps

Catalog Number	Tip	Teeth	Length (in.)
US147	SERR	-	7 3/4
MB231	SMOOTH	1 x 2	7 1/4

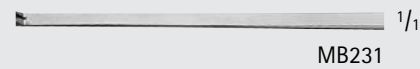

BROWN-CUSHING Bayonet Forceps

Catalog Number	Teeth	Length (in.)
MB227	7 x 7	7 1/4

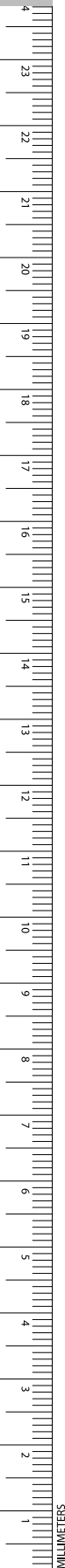



BROWN-BAHNSON Bayonet Forceps

Catalog Number	Tip	Length (in.)
BD876R	SERR	6 1/8
MB804R	SERR	8

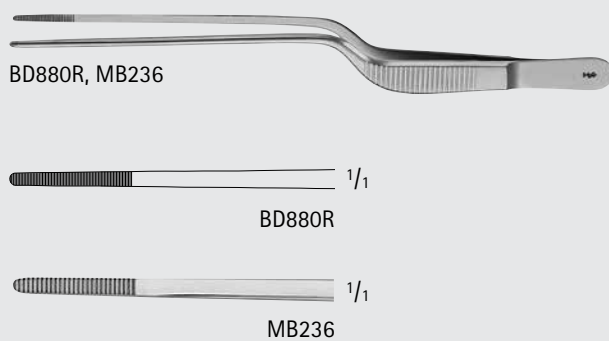

JANSEN Bayonet Forceps

Catalog Number	Tip	Length (in.)
BD880R	SERR	6 1/4
MB236	SERR	6 1/2

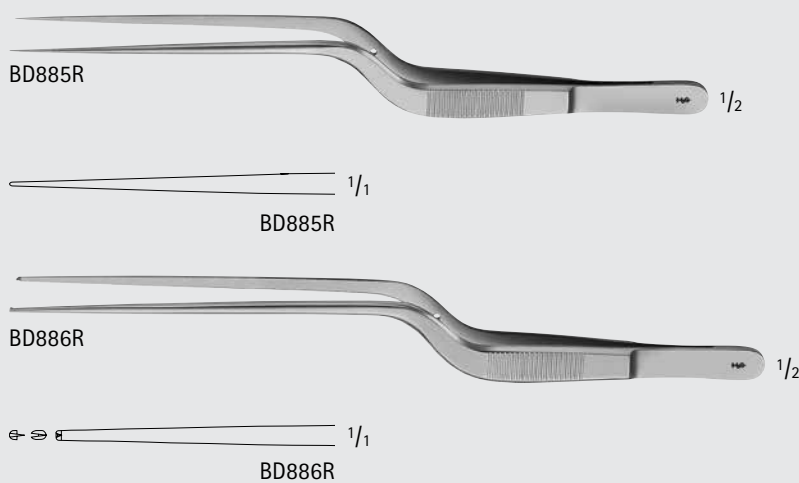

Bayonet Forceps

Catalog Number	Tip	Teeth	Length (in.)
BD885R	SMOOTH	-	7 1/4
BD886R	SMOOTH	1 x 2	7 7/8

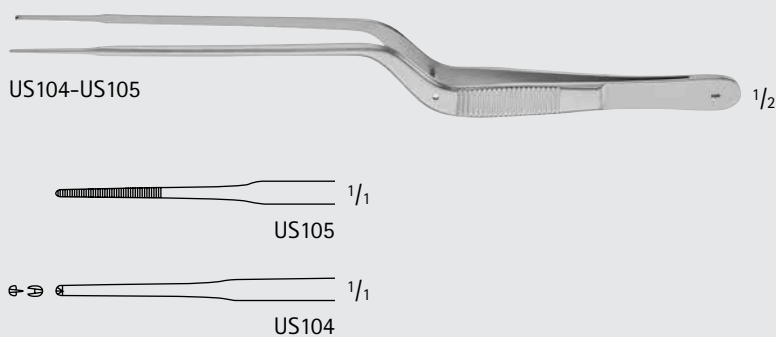

GERALD Bayonet Forceps

Catalog Number	Tip	Teeth	Length (in.)
US105	SERR	-	7 1/2
US104	SMOOTH	1 x 2	7 1/2

General Surgery

Dressing and Tissue Forceps

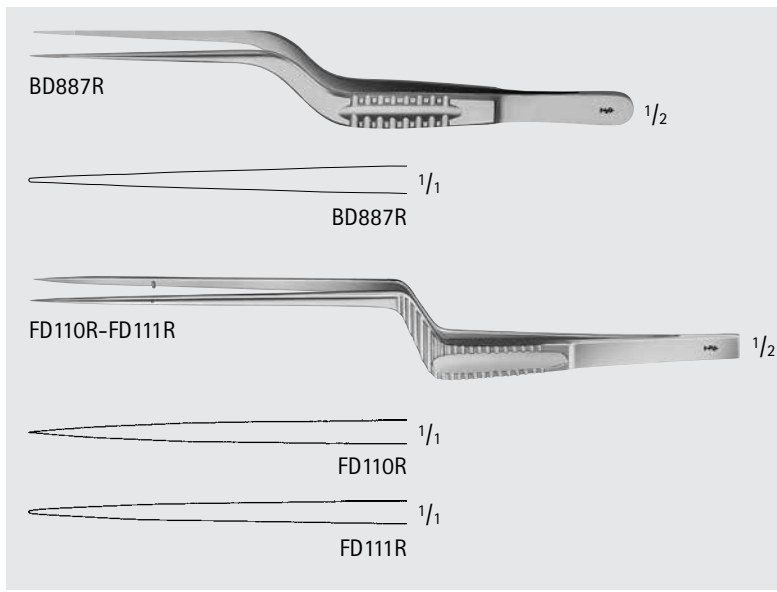

Bayonet Forceps

Catalog Number	Tip	Length (in.)
BD887R		6 1/4
FD110R	FINE	7 1/4
FD111R	BROAD	7 1/4

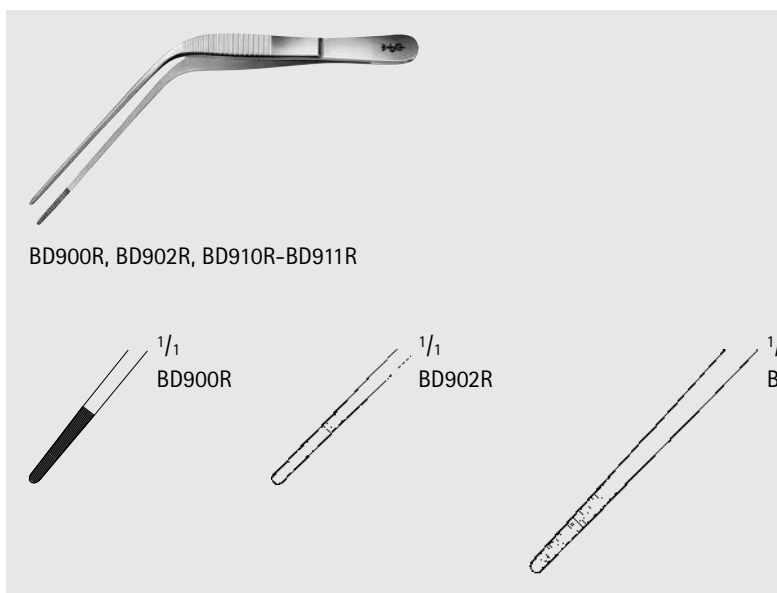

TROELTSCH Bayonet Forceps

Catalog Number	Tip	Length (in.)
BD900R	ANG/SERR	4
BD902R	ANG/SERR	4 1/2
BD910R	ANG/SERR	5 1/2
BD911R	ANG/SERR	6 3/4

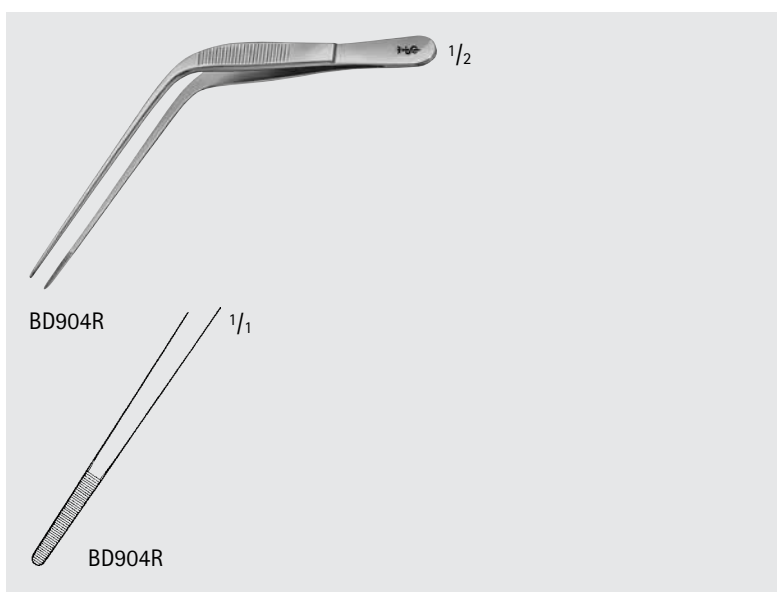

WILDE Bayonet Forceps

Catalog Number	Tip	Length (in.)
BD904R	ANG/SERR	4 1/2

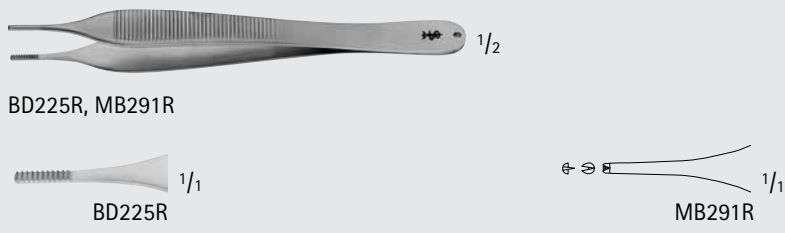

HUDSON Forceps

Catalog Number	Tip	Teeth	Length (in.)
BD225R	SERR	-	5
MB291R	SMOOTH	1 x 2	5

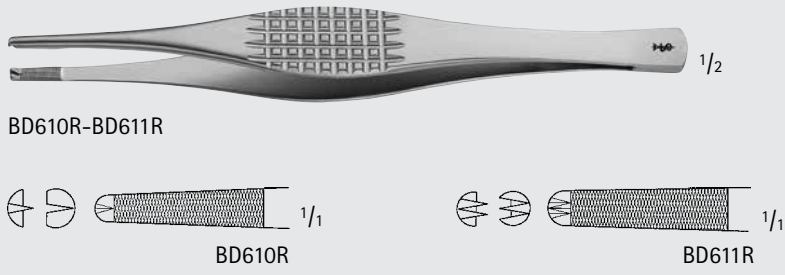

FERRIS-SMITH Tissue Forceps

Catalog Number	Tip	Teeth	Length (in.)
BD610R	X-SERR	1 x 2	6 7/8
BD611R	X-SERR	2 x 3	6 7/8



SEMKEN Forceps, Delicate

Catalog Number	Tip	Teeth	Length (in.)
BD215R	SERR	-	5
BD216R	SERR	-	6
BD665R	SMOOTH	1 x 2	5
BD667R	SMOOTH	1 x 2	6
BD666R	SMOOTH	2 x 3	5

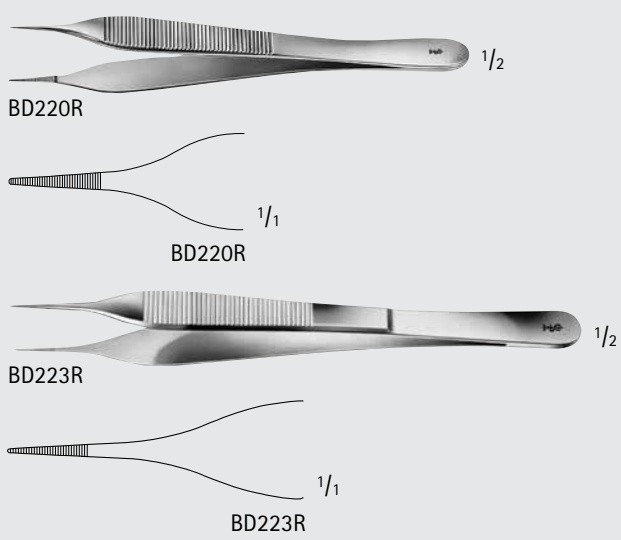
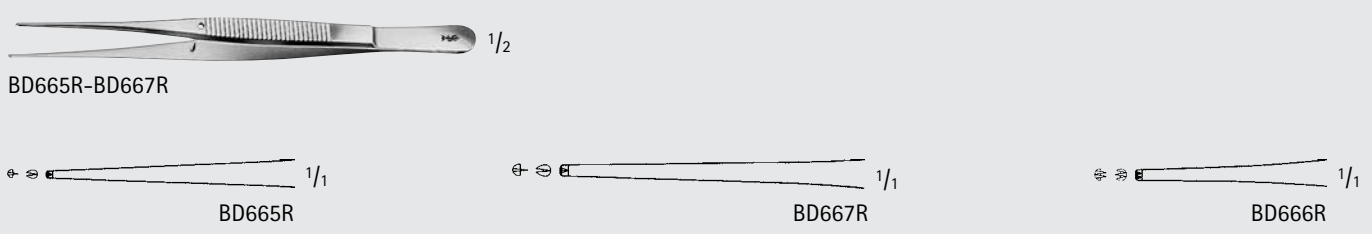

Micro ADSON Forceps, Delicate

Catalog Number	Tip	Length (in.)
BD220R	SERR, W/ PLATFORM	4 3/4
BD223R	SERR	6

General Surgery

Dressing and Tissue Forceps

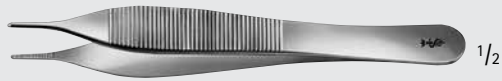

BD222R, MA156R

1/2



BD222R

MA156R

1/1

1/1



BD511R

1/2

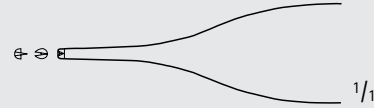

1/1



MG275R

1/2

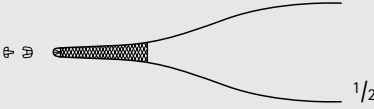

1/2



BD512R

1/2

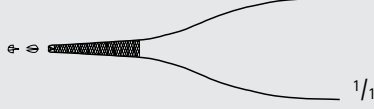

1/1



MA536R

1/2



1/1

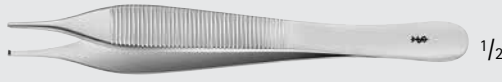

MB454R

1/2

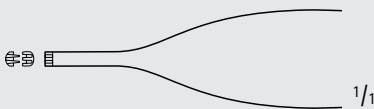

1/1

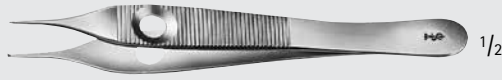

BD506R

1/2

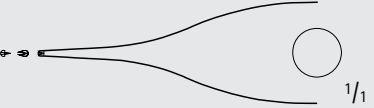

1/1

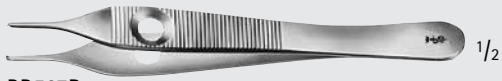

BD507R

1/2

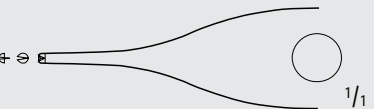

1/1



BD508R

1/2

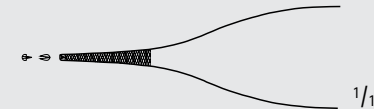

1/1

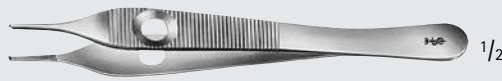

BD513R

1/2

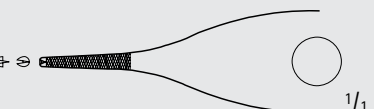

1/1

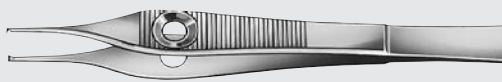

BD521R

1/2

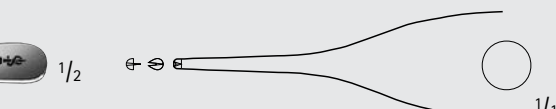

1/1

ADSON Forceps, Delicate

Catalog Number	Tip	Teeth	Handle	Length (in.)
BD222R	SERR	-	-	4 3/4
MA156R	SERR, X-LONG	-	-	4 3/4
BD511R	SMOOTH	1 x 2	-	4 3/4
MG275R	SERR	1 x 2	-	4 3/4
BD512R	X-SERR W/ PLATFORM	1 x 2	-	4 3/4
MA536R	X-LONG	1 x 2	-	4 3/4
MB454R	SMOOTH	2 x 3	-	4 3/4
BD506R	SMOOTH	1 x 2	FENE-STRATED	4 3/4
BD507R	SMOOTH	1 x 2	FENE-STRATED	4 3/4
BD508R	SERR	1 x 2	FENE-STRATED	4 3/4
BD513R	X-SERR W/ PLATFORM	1 x 2	FENE-STRATED	4 3/4
BD521R	SMOOTH	1 x 2	FENE-STRATED	6



MUSTARDE Suture Removal Forceps

Catalog Number	Tip	Length (in.)
MG358R	LONGITUDINAL, SERR	5

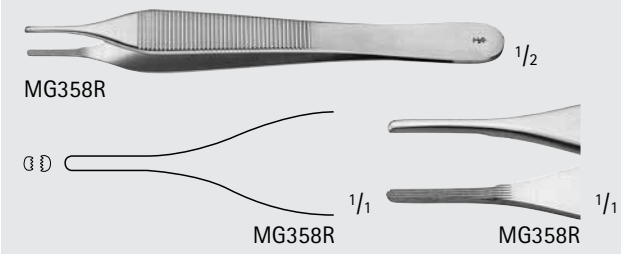

CALLISON-ADSON Tissue Forceps, W/ Platform

Catalog Number	Teeth	Length (in.)
MA537R	1 x 2	5

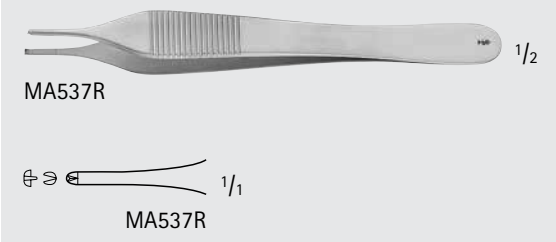

ADSON-BROWN Tissue Forceps

Catalog Number	Teeth	Length (in.)
BD700R	7 x 8	4 3/4

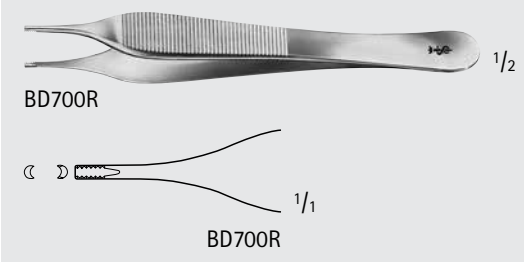

BROWN Tissue Forceps

Catalog Number	Teeth	Length (in.)
BD701R	7 x 8	6
BD702R	7 x 8	7 7/8

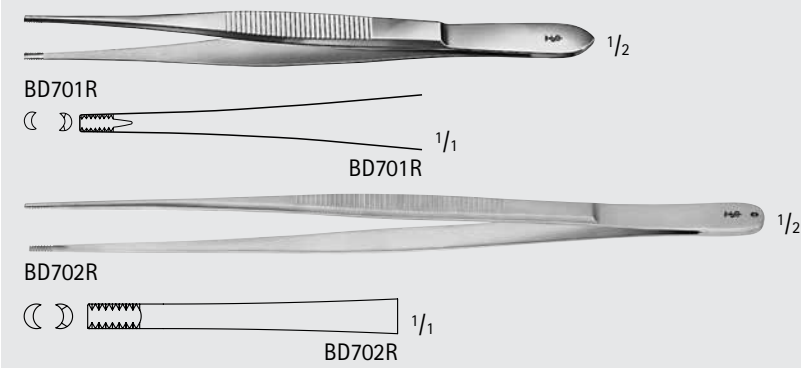

MICRO ADSON Tissue Forceps, Delicate

Catalog Number	Teeth	Length (in.)
BD510R	1 x 2	4 3/4
BD520R	1 x 2	6

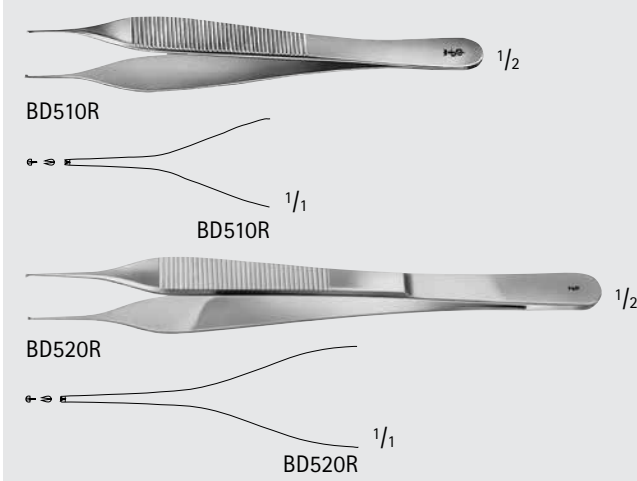

General Surgery

Dressing and Tissue Forceps



BD662R-BD664R

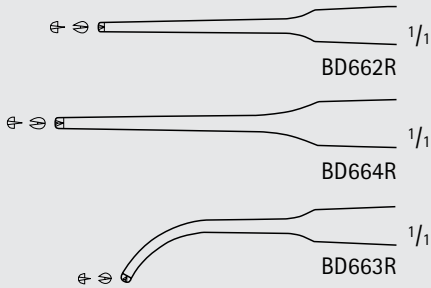

GERALD Tissue Forceps, Delicate

Catalog Number	Tip	Teeth	Length (in.)
BD662R	STR	1 x 2	6 7/8
BD664R	STR	1 x 2	9
BD663R	CVD	1 x 2	6 7/8

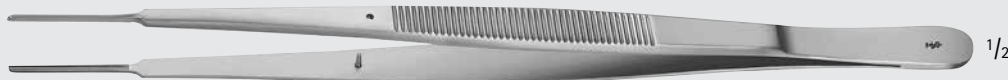

MG422R

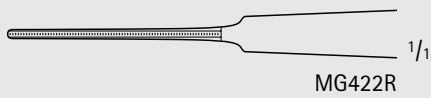

GERALD-DEBAKEY Forceps, Narrow

Catalog Number	Tip	Length (in.)
MG422R	SERR	9



BD522R

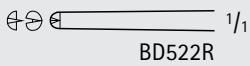

ADSON Tissue Forceps, Delicate

Catalog Number	Teeth	Length (in.)
BD522R	1 x 2	7



BD523R



JEFFERSON Tissue Forceps, Delicate

Catalog Number	Teeth	Length (in.)
BD523R	1 x 2	7



BD228R-BD230R

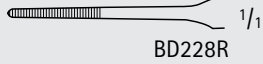

BD228R

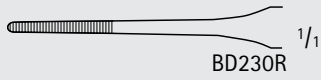

BD230R

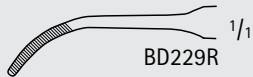

BD229R

GERALD Dressing Forceps, Delicate

Catalog Number	Tip	Length (in.)
BD228R	STR, SERR	6 7/8
BD230R	STR, SERR	9
BD229R	CVD, SERR	6 7/8



BD236R

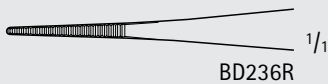

BD236R

MCINDOE Thumb Forceps, Delicate

Catalog Number	Tip	Length (in.)
BD236R	SERR	6



BD661R



BD661R

MCINDOE Tissue Forceps, Delicate

Catalog Number	Tip	Teeth	Length (in.)
BD661R	SERR	1 x 2	6

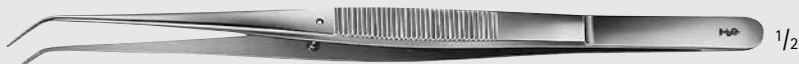

BD257R

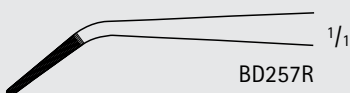

BD257R

Delicate Forceps, Angled

Catalog Number	Tip	Length (in.)
BD257R	SERR	7 7/8



INCHES

General Surgery

Dressing and Tissue Forceps



BD238R-BD243R



BD238R

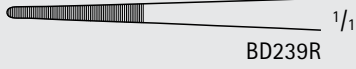

BD239R

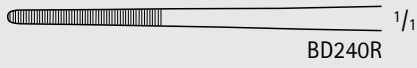

BD240R

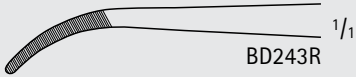

BD243R

CUSHING Forceps, Delicate

Catalog Number	Tip	Length (in.)
BD238R	STR, SERR	7
BD239R	STR, SERR	7 7/8
BD240R	STR, SERR	9 3/4
BD243R	CVD, SERR	7 7/8



MD463

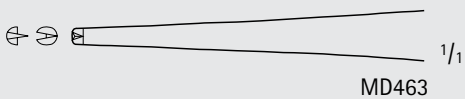

MD463

CUSHING Tissue Forceps

Catalog Number	Teeth	Length (in.)
MD463	1 x 2	7



BD246R

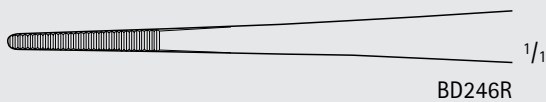

BD246R

BROPHY Forceps, Delicate

Catalog Number	Tip	Length (in.)
BD246R	SERR	7 7/8

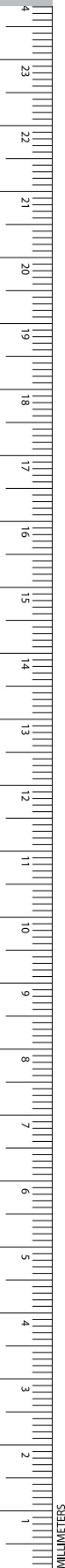



BD231R-BD232R

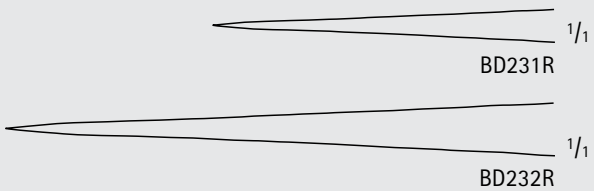

Forceps, Delicate

Catalog Number	Tip	Length (in.)
BD231R	SMOOTH	7
BD232R	SMOOTH	7 7/8



BD301R-BD305R

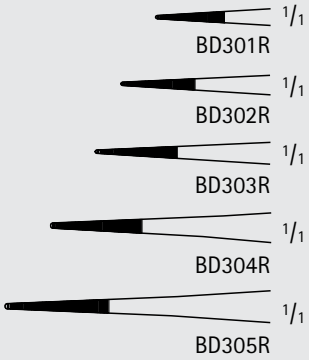

Micro Dressing Forceps

Catalog Number	Tip	Length (in.)
BD301R	STR, SERR	3 1/2
BD302R	STR, SERR	4 1/8
BD303R	STR, SERR	4 1/2
BD304R	STR, SERR	5 1/8
BD305R	STR, SERR	5 3/4
BD311R	CVD, SERR	3 1/2
BD312R	CVD, SERR	4 1/8
BD313R	CVD, SERR	4 1/2
BD314R	CVD, SERR	5 1/8
BD315R	CVD, SERR	5 3/4



BD311R-BD315R

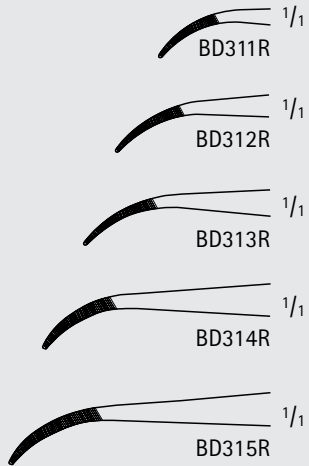

INCHES

General Surgery

Dressing and Tissue Forceps

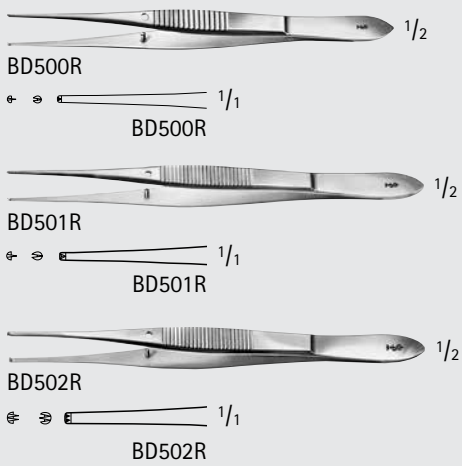

Micro Tissue Forceps

Catalog Number	Teeth	Length (in.)
BD500R	1 x 2	4
BD501R	1 x 2	4 1/4
BD502R	2 x 3	4 1/4

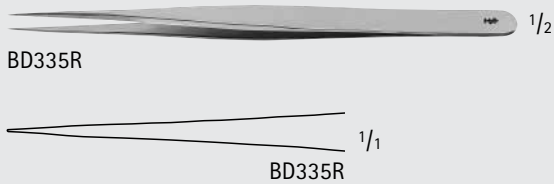

Micro Forceps #3 Jewelers

Catalog Number	Tip Size (mm)	Length (in.)
BD335R	0.3	5 1/4

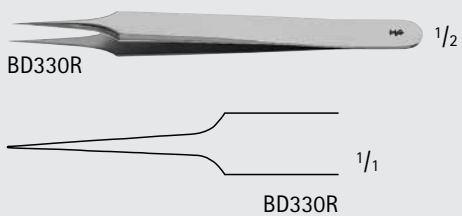

Micro Forceps #4 Jewelers

Catalog Number	Tip Size (mm)	Length (in.)
BD330R	0.2	4 1/4

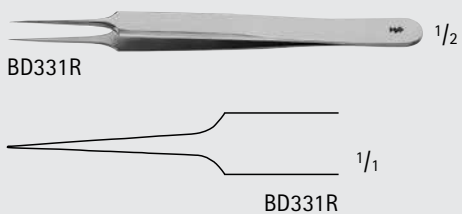

Micro Forceps #5 Jewelers

Catalog Number	Tip Size (mm)	Length (in.)
BD331R	0.15	4 1/4

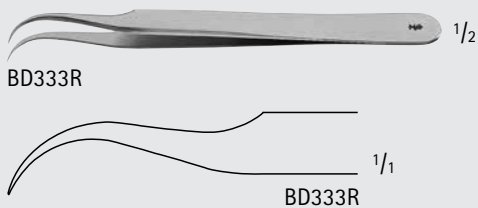

Micro Forceps #7 Jewelers

Catalog Number	Tip Size (mm)	Length (in.)
BD333R	0.2	4 1/2

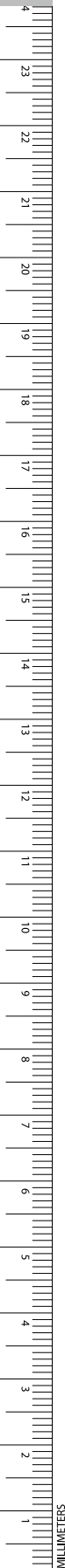



GILLIES Tissue Forceps, Delicate

Catalog Number	Tip	Teeth	Length (in.)
BD660R	X-SERR	1 x 2	6 1/8

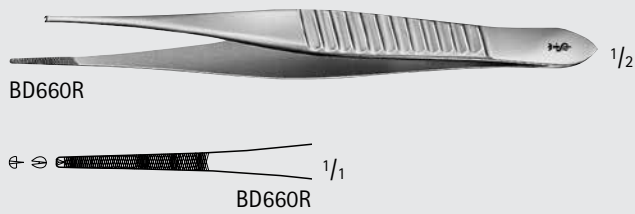

SEMKEN Tissue Forceps, Delicate

Catalog Number	Teeth	Length (in.)
BD669R	1 x 2	5 3/4

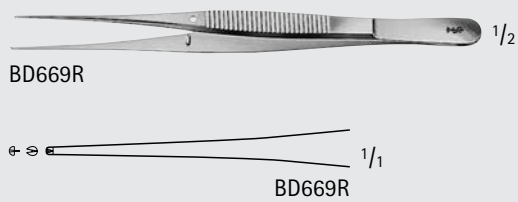

WAUGH Tissue Forceps, Delicate

Catalog Number	Tip	Teeth	Length (in.)
BD670R	X-SERR	1 x 2	7
BD671R	X-SERR	1 x 2	7 7/8
BD672R	X-SERR	1 x 2	9 3/4
BD679R	X-SERR	1 x 2	12

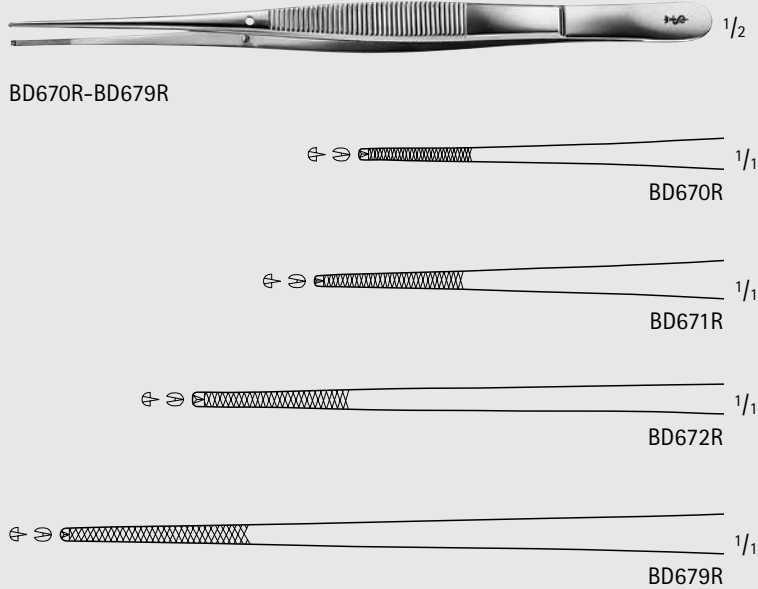

DOCKTOR Forceps

Catalog Number	Tip	Teeth	Length (in.)
MB211R	X-SERR	1 x 2	4 3/4

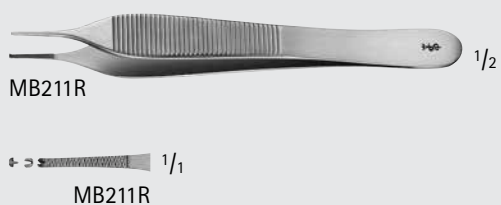

General Surgery

Dressing and Tissue Forceps



DEBAKEY Atraumatic Ultra Light Forceps

Catalog Number	Tip Size (mm)	Length (in.)
FC411R	1.2	6
FC412R	1.5	7 7/8
FC413R	1.5	9 1/2
FC418R	1.5	11 3/4

DEBAKEY Atraumatic Vascular Tissue Forceps

Catalog Number	Tip Size (mm)	Length (in.)
FB394R	1	6
FB395R	1	7 3/4
FB396R	1	9 1/2

DEBAKEY Atraumatic Forceps

Catalog Number	Tip Size (mm)	Length (in.)
FB411R	1.5	6
FB412R	1.5	7 7/8
FB418R	1.5	9 1/2
FB419R	1.5	11 3/4

DEBAKEY Atraumatic Forceps

Catalog Number	Tip Size (mm)	Length (in.)
FB400R	2	6
FB402R	2	7 7/8
FB404R	2	9 1/2
FB405R	2	11 3/4
FB414R	2.8	6
FB415R	2.8	7 7/8
FB416R	2.8	9 1/2
FB417R	2.8	11 3/4
FB406R	3.5	7 7/8
FB407R	3.5	9 1/2
FB408R	3.5	11 3/4
FB409R	3.5	13 3/4

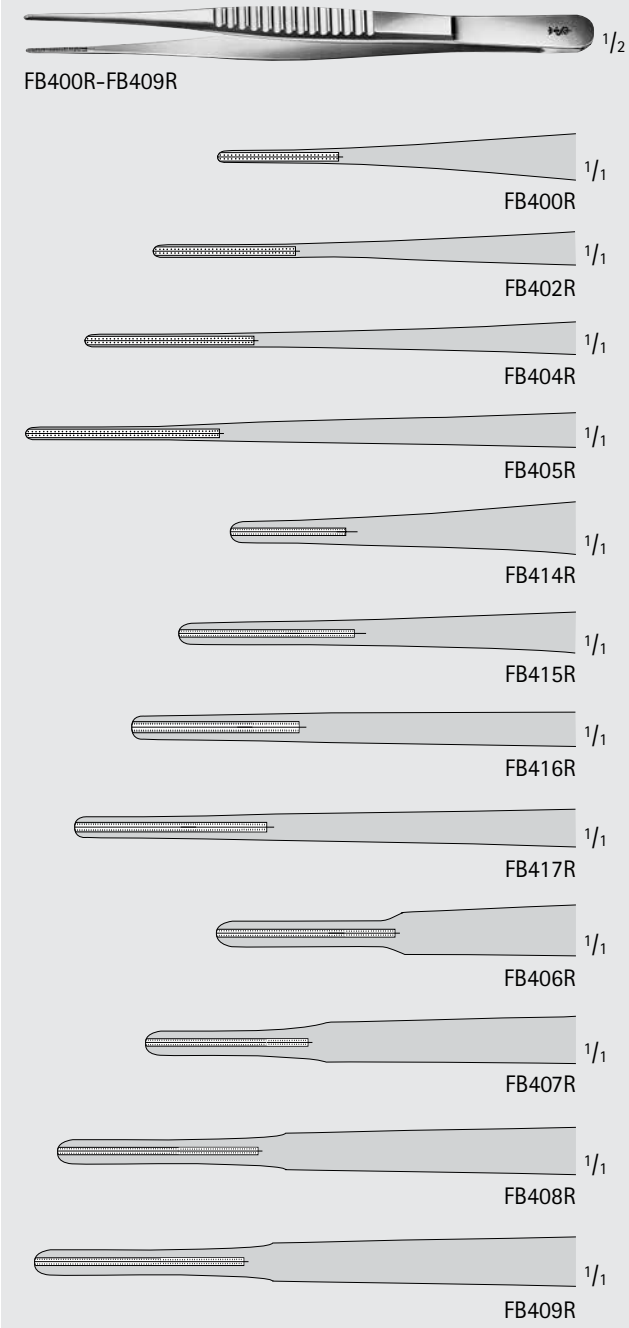

General Surgery

Dressing and Tissue Forceps



FB401R-FB410R

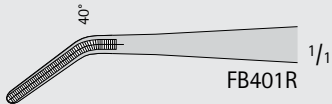

FB401R

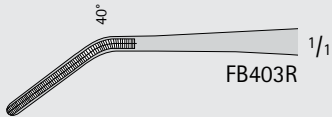

FB403R

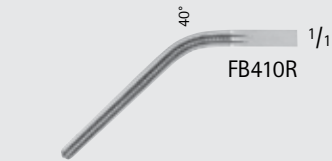

FB410R

DEBAKEY Atraumatic Forceps, Angled

Catalog Number	Tip Size (mm)	Length (in.)
FB401R	2	6
FB403R	2	7 7/8
FB410R	2	9 1/2



FB784R



FB784R



FB785R



FB785R



FB786R



FB786R

COOLEY Atraumatic Vascular Tissue Forceps

Catalog Number	Tip Size (mm)	Length (in.)
FB784R	1.5	6
FB785R	2.0	7 3/4
FB786R	2.3	9 1/2

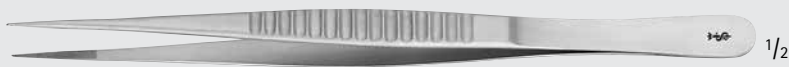

BD250R



BD250R

COOLEY Vascular Tissue Forceps

Catalog Number	Length (in.)
BD250R	7 7/8

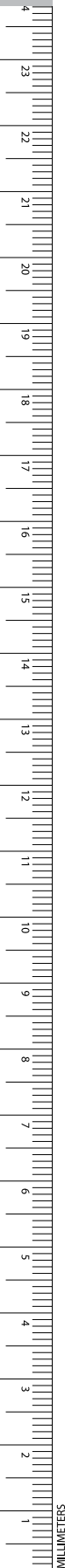



BD770R

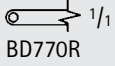

MILLS Mammary/Coronary Tissue Forceps

Catalog Number	Length (in.)
BD770R	7



FB130R

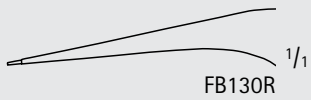

Dilator Forceps

Catalog Number	Tip Size (mm)	Length (in.)
FB130R	0.2	4 1/2



BD980R

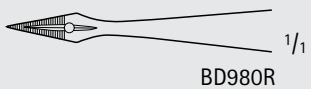

HUNTER Splinter Forceps

Catalog Number	Length (in.)
BD980R	4 1/8

General Surgery

DUROGRIP™ TC Tissue Forceps

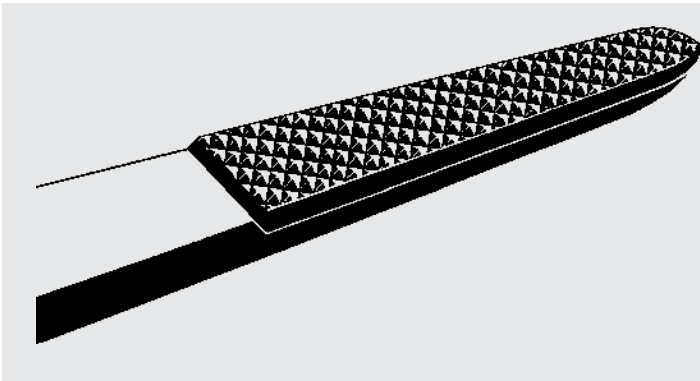

DUROGRIP Tungsten Carbide Tissue Forceps

- Cross-Serrated Platform tips for firm and non-traumatic grip
- Long working life
- Gold-plated end



BD151R

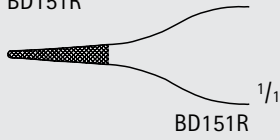

BD151R



US109-US110

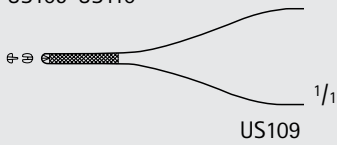

US109

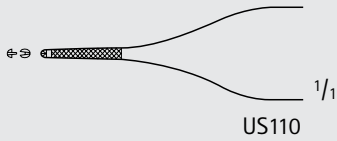

US110



MB484R-MB485R



MB484R



MB485R

DUROGRIP TC ADSON Forceps

Catalog Number	Tip	Teeth	Length (in.)
BD151R	X-SERR	-	4 3/4
US109	X-SERR	1 x 2	4 3/4
US110	DEL, X-SERR	1 x 2	4 3/4
MB484R	X-SERR	1 x 2	6
MB485R	DEL, X-SERR	1 x 2	6



US112

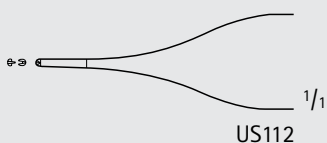

US112

DUROGRIP TC GORNEY-ADSON Forceps

Catalog Number	Tip	Teeth	Length (in.)
US112	DEL, SMOOTH	1 x 2	4 3/4

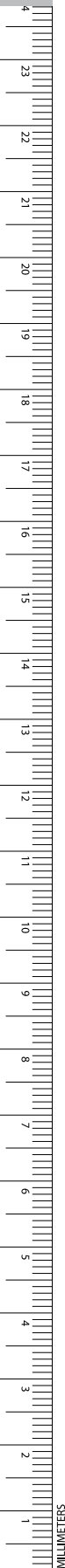

DUROGRIP TC DEBAKEY Needle Forceps

Catalog Number	Tip	Tip Size (mm)	Length (in.)
MB782R	-	1.5	6
MB783R	-	1.5	7 3/4
US119	NARROW	1.5	7 3/4
MB779R	-	2	6
MB780R	-	2	8
MB781R	-	2	10 1/2
US117	-	2	6
US118	-	2	8
US120	NARROW	2	9

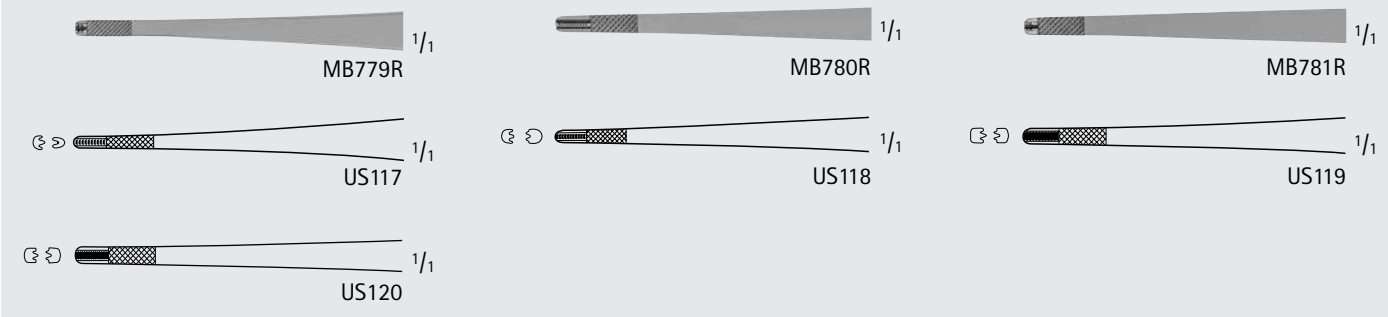
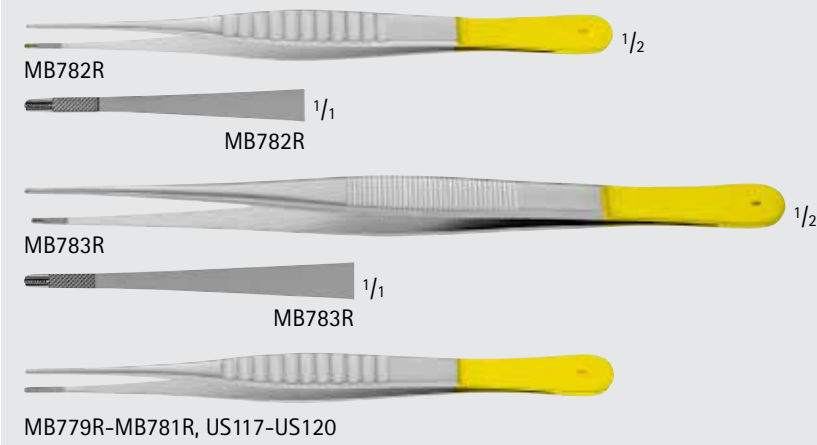

GERALD Needle Forceps

Catalog Number	Tip	Teeth	Length (in.)
MG356R	X-SERR	1 x 2	6 7/8



DUROGRIP TC (POTTS-SMITH) Thumb Forceps

Catalog Number	Tip	Length (in.)
BD154R	X-SERR	5 3/4
BD156R	X-SERR	7
BD157R	X-SERR	7 7/8
BD158R	X-SERR	9
BD159R	X-SERR	9 3/4

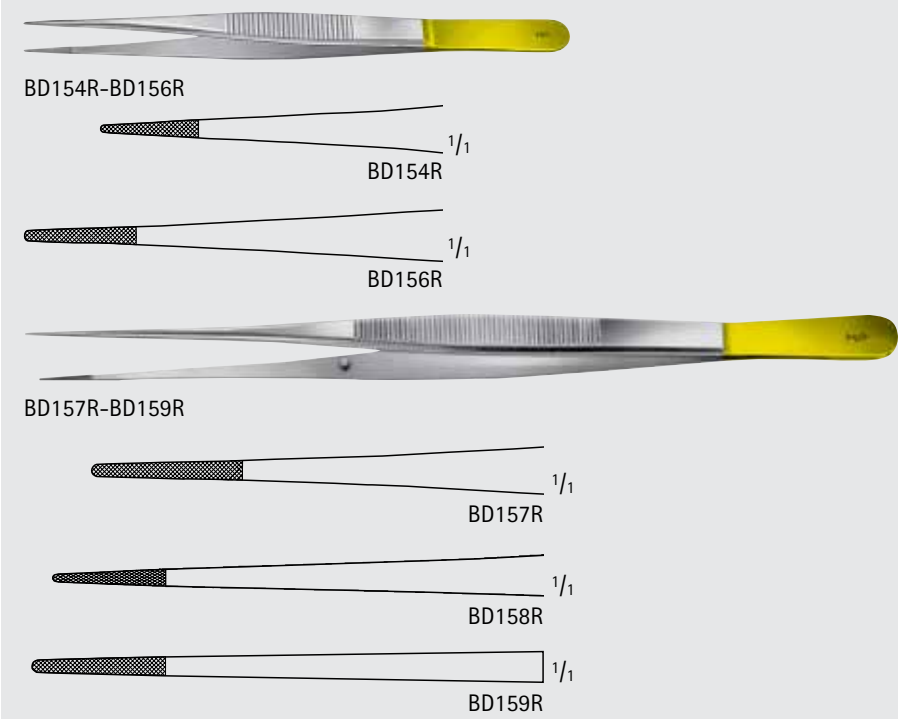

INCHES

General Surgery

DUROGRIP™ TC Tissue Forceps

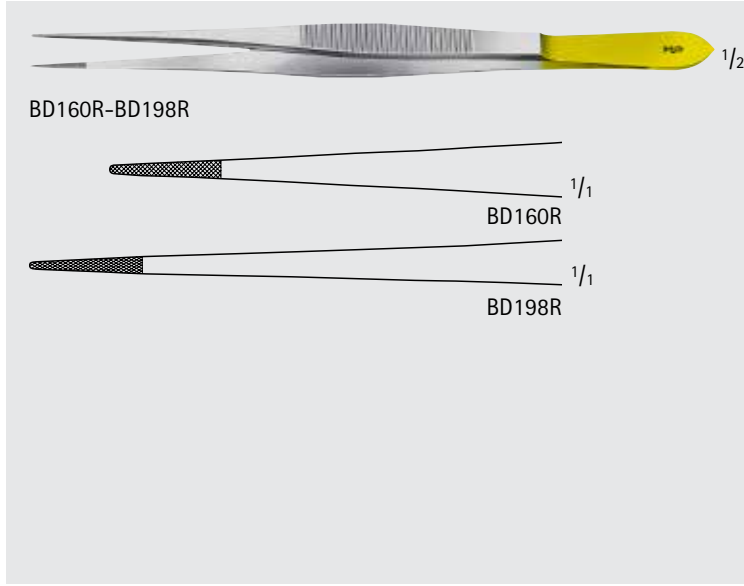

DUROGRIP TC CUSHING Forceps, W/ Scraper End

Catalog Number	Tip	Length (in.)
BD160R	X-SERR	7
BD198R	X-SERR	9 3/4

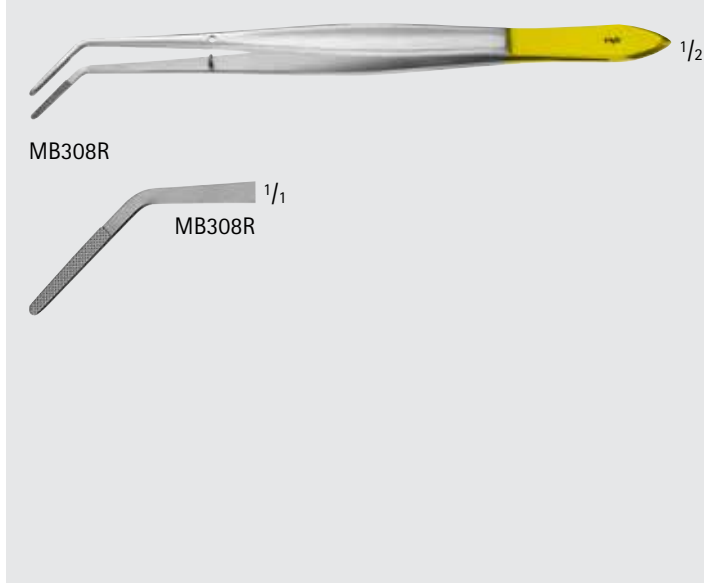

DUROGRIP TC CUSHING Forceps

Catalog Number	Tip	Length (in.)
MB308R	ANG, X-SERR	6 1/4

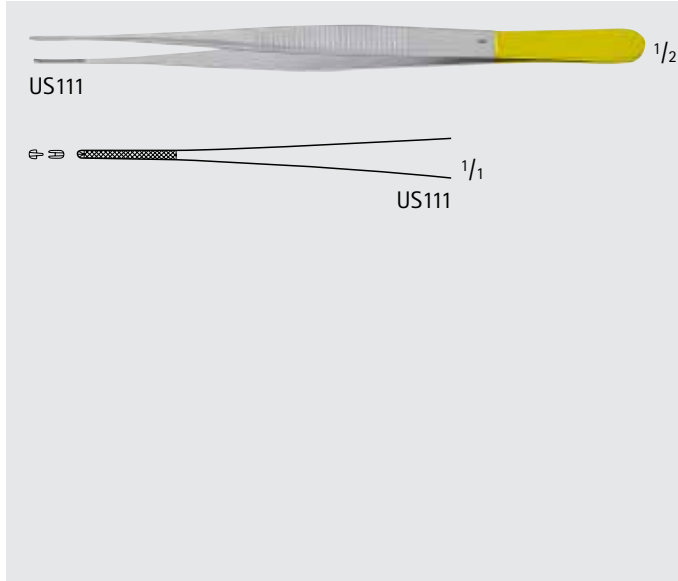

DUROGRIP TC SEMKEN Forceps

Catalog Number	Tip	Tip Size (mm)	Teeth	Length (in.)
US111	X-SERR	1	1 x 2	6 1/4



BD164R-BD166R

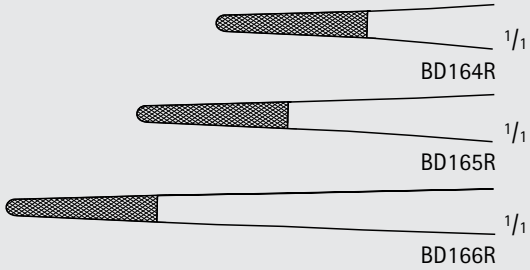

DUROGRIP TC STANDARD Forceps

Catalog Number	Tip	Length (in.)
BD164R	X-SERR	5 3/4
BD165R	X-SERR	7 7/8
BD166R	X-SERR	9 3/4



BD168R

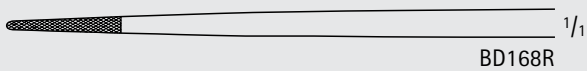

DUROGRIP TC GRUENWALD Forceps

Catalog Number	Tip	Length (in.)
BD168R	X-SERR	7 1/4



BD171R-BD173R

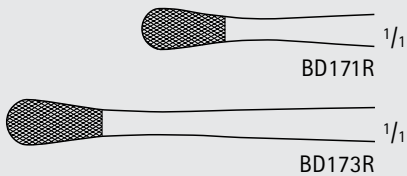

DUROGRIP TC WANGENSTEEN Forceps

Catalog Number	Tip	Length (in.)
BD171R	X-SERR	6
BD173R	X-SERR	9



INCHES

General Surgery

Abdominal and Intestinal Grasping Forceps

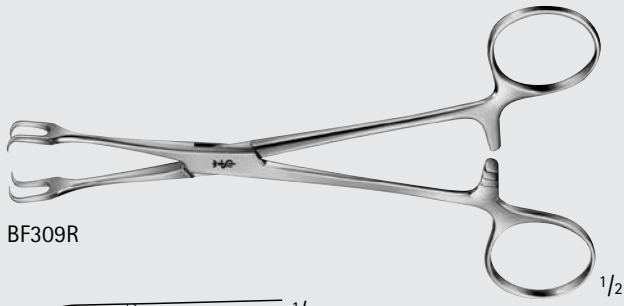

BF309R

1/2

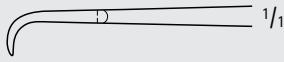

BF309R

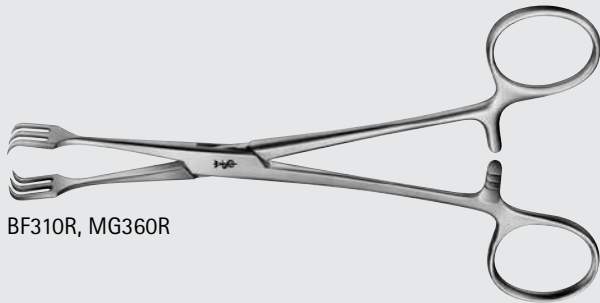

BF310R, MG360R

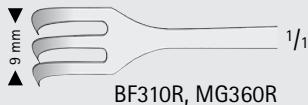
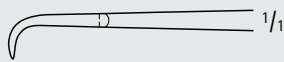

BF310R, MG360R

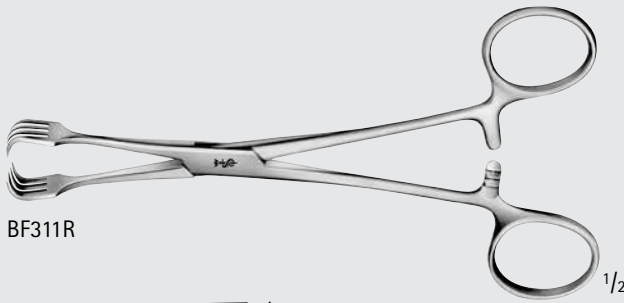

BF311R

1/2

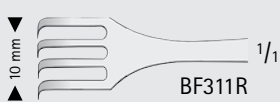
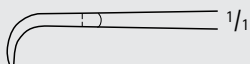

BF311R

LAHEY Forceps

Catalog Number	Teeth	Length (in.)
BF309R	2 x 2	6 1/8
BF310R	3 x 3	6 1/8
MG360R	3 x 3	8
BF311R	4 x 4	6 1/8

General Surgery

Abdominal and Intestinal Grasping Forceps



BOYS-ALLIS Forceps

Catalog Number	Teeth	Length (in.)
EA010R	5 x 6	6 1/8

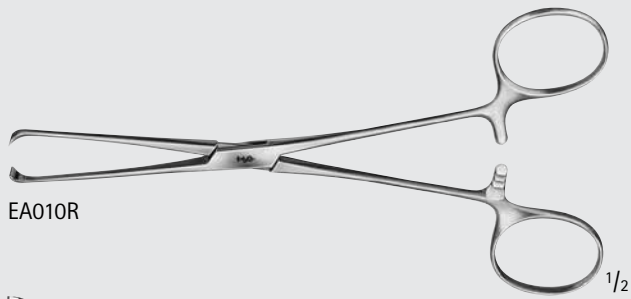

EA010R



EA010R

Baby ALLIS Forceps

Catalog Number	Teeth	Length (in.)
EA012R	4 x 5	5 1/8

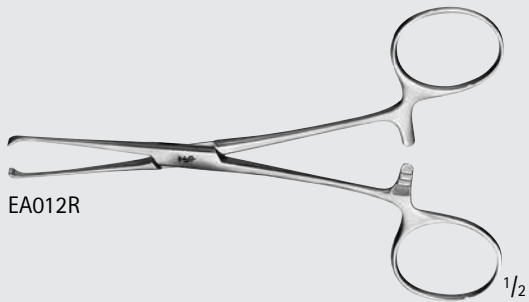

EA012R

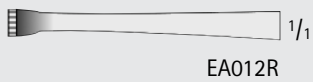

EA012R

ALLIS Forceps

Catalog Number	Teeth	Length (in.)
EA015R	4 x 5	6 1/8
EA016R	5 x 6	6 1/8
EA017R	5 x 6	7 1/2
FB938R	5 x 6	8 3/4
EA018R	5 x 6	10
MB910R	5 x 6	16

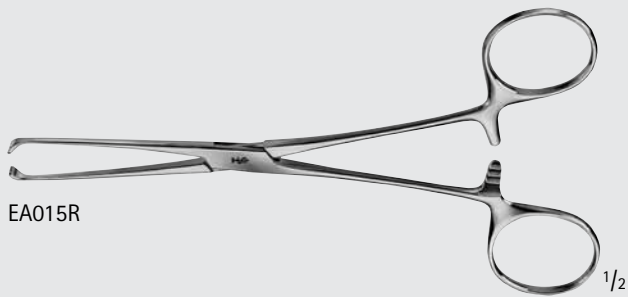

EA015R



EA015R

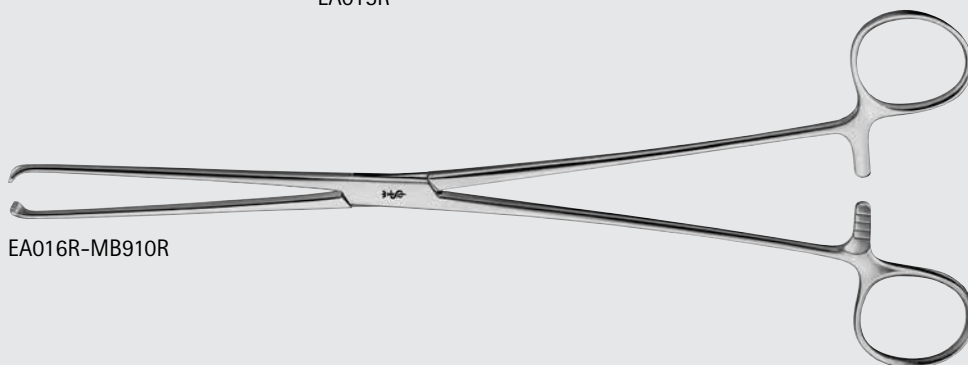

EA016R-MB910R



EA016R-MB910R

General Surgery

Abdominal and Intestinal Grasping Forceps

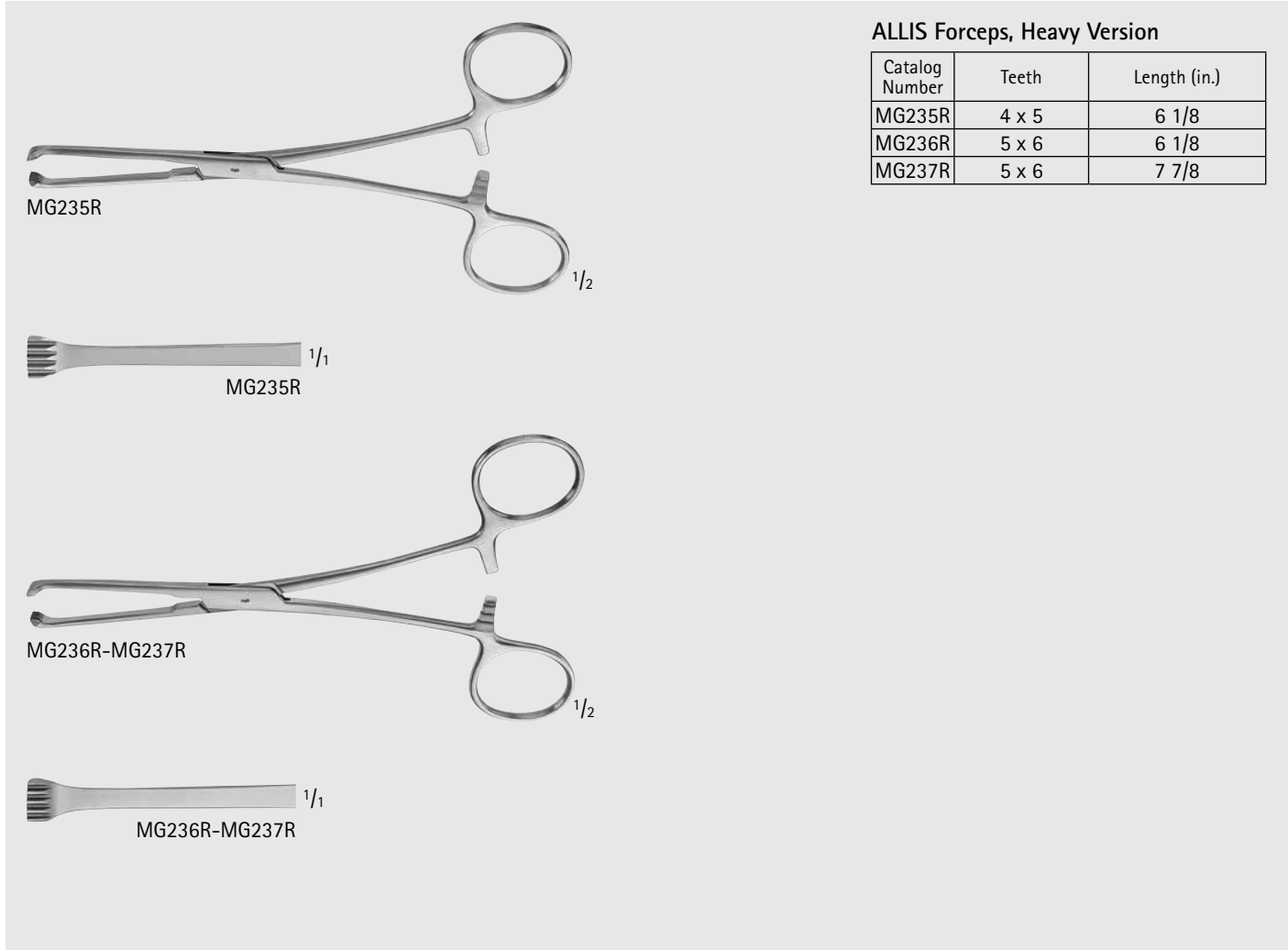

ALLIS Forceps, Heavy Version

Catalog Number	Teeth	Length (in.)
MG235R	4 x 5	6 1/8
MG236R	5 x 6	6 1/8
MG237R	5 x 6	7 7/8

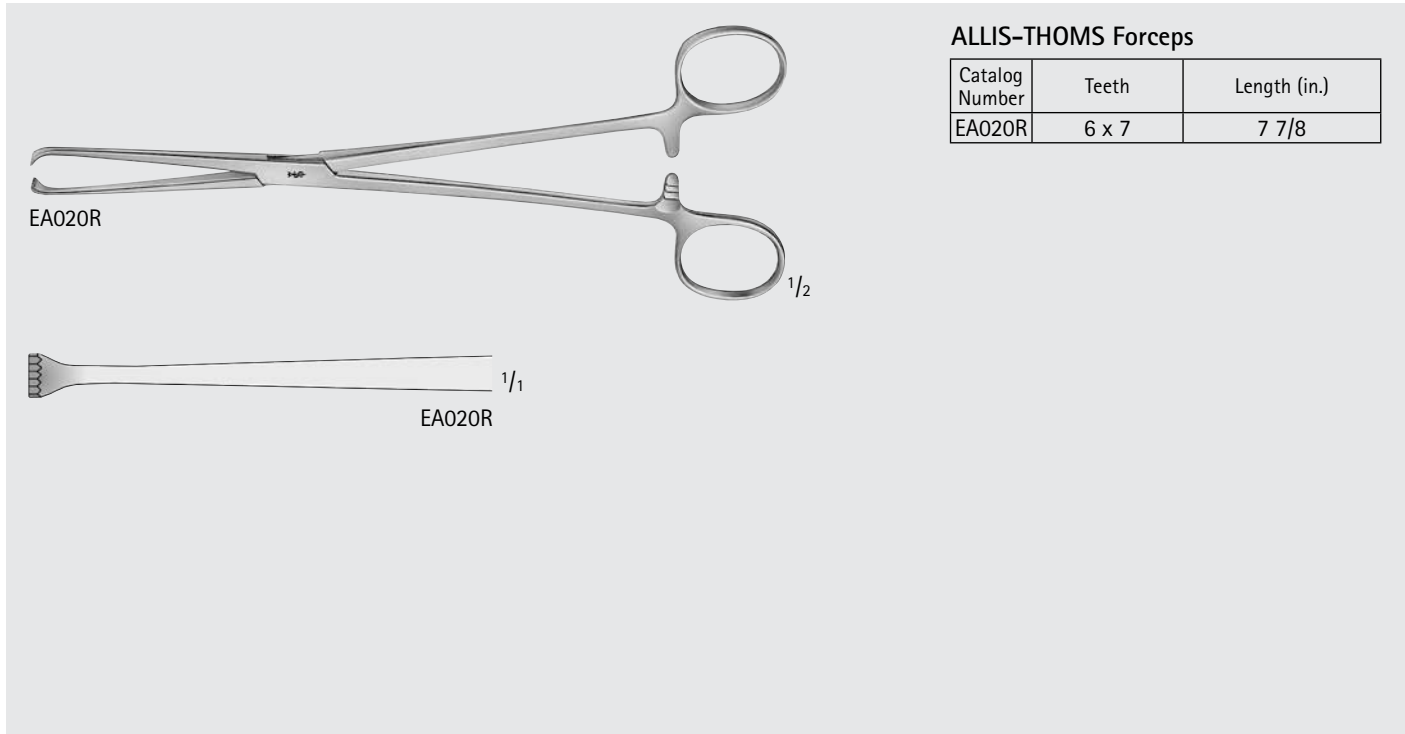

ALLIS-THOMS Forceps

Catalog Number	Teeth	Length (in.)
EA020R	6 x 7	7 7/8

General Surgery

Abdominal and Intestinal Grasping Forceps



JUDD-ALLIS Forceps

Catalog Number	Teeth	Length (in.)
EA025R	3 x 4	6 1/8
EA026R	3 x 4	7 7/8

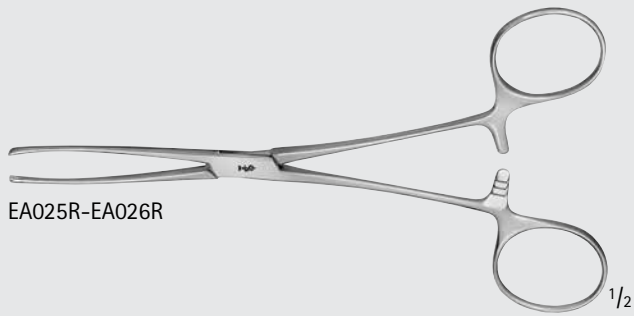

EA025R-EA026R

1/2

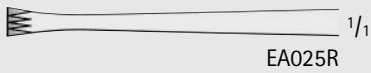

EA025R

1/1

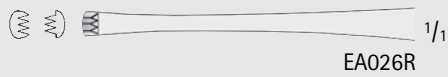

EA026R

1/1

ALLIS-ADAIR Clamp

Catalog Number	Teeth	Length (in.)
MD568	9 x 10	6 1/4

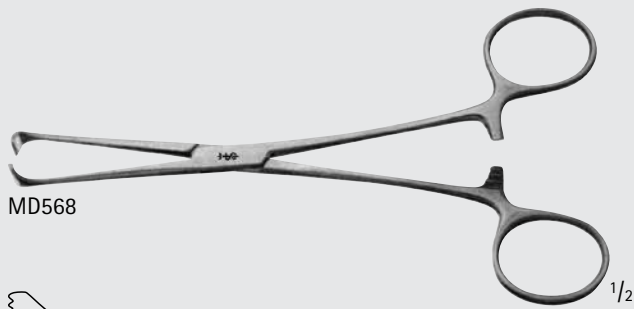

MD568

1/2

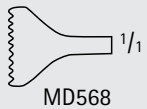

MD568

1/1

LOCKWOOD-ALLIS Intestinal Clamp

Catalog Number	Teeth	Length (in.)
MG455R	4 x 5	6 1/2

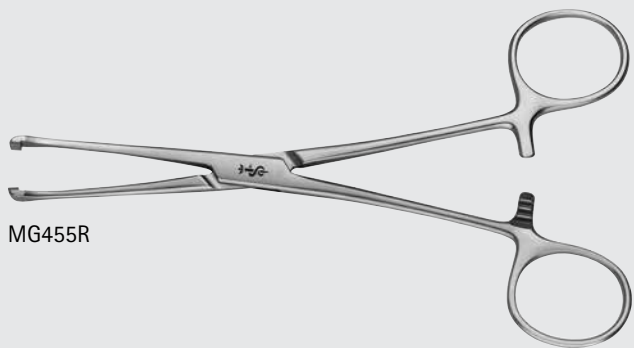

MG455R

1/2



MG455R

1/1

General Surgery

Abdominal and Intestinal Grasping Forceps

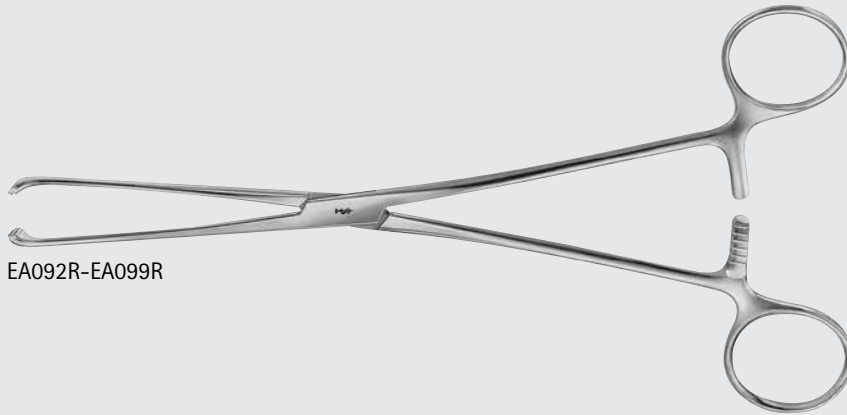

EA092R-EA099R

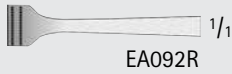

EA092R

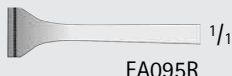

EA095R



EA096R

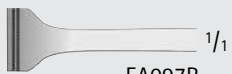

EA097R

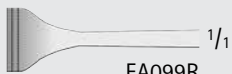

EA099R

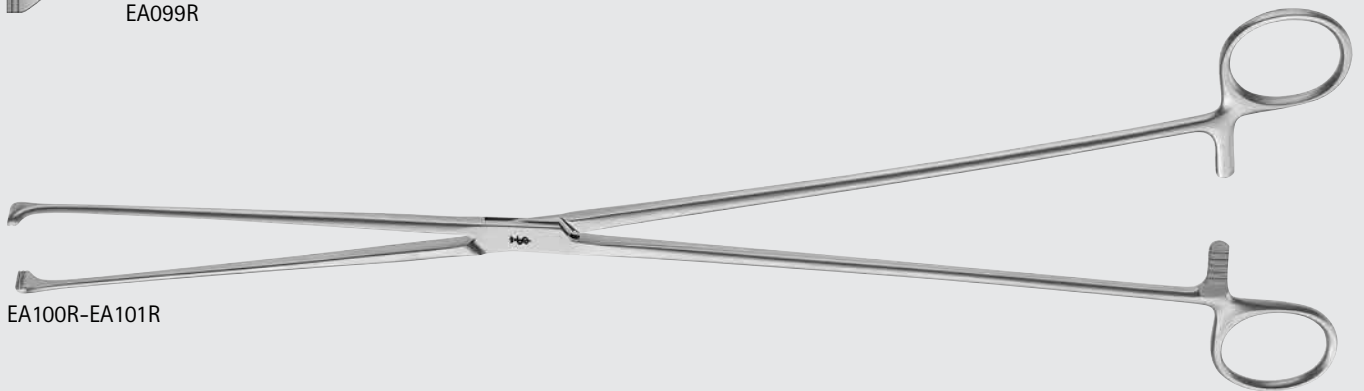

EA100R-EA101R

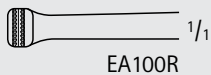

EA100R



EA101R

ALLIS Atraumatic Forceps

Catalog Number	Length (in.)
EA092R	6 1/4
EA095R	7 7/8
EA096R	8 3/4
EA097R	10
EA100R	11 5/8
EA099R	11 3/4
EA101R	14

General Surgery

Abdominal and Intestinal Grasping Forceps

GENERAL SURGERY



GLASSMAN-ALLIS Common Duct Forceps Non-Crushing

Catalog Number	Length (in.)
MG435R	8 1/2

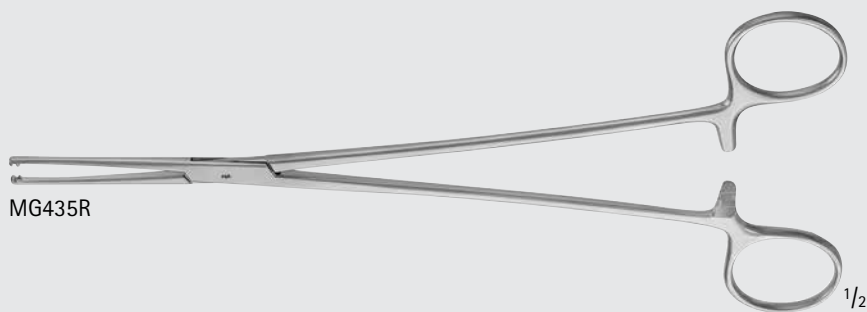

MG435R

1/2



MG435R

BABCOCK Tissue Holding Forceps

Catalog Number	Length (in.)
MB136R	12
MB137R	14



MB136R-MB137R

1/2



MB136R

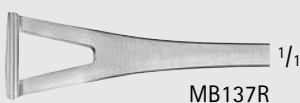

MB137R

INCHES

General Surgery

Abdominal and Intestinal Grasping Forceps



EA030R-MG359R



MG359R $\frac{1}{1}$

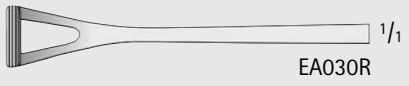

EA030R $\frac{1}{1}$

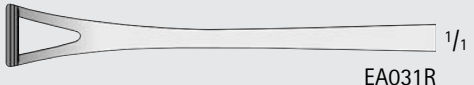

EA031R $\frac{1}{1}$

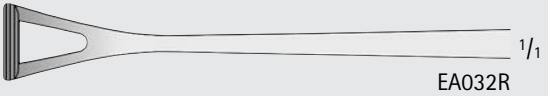

EA032R $\frac{1}{1}$

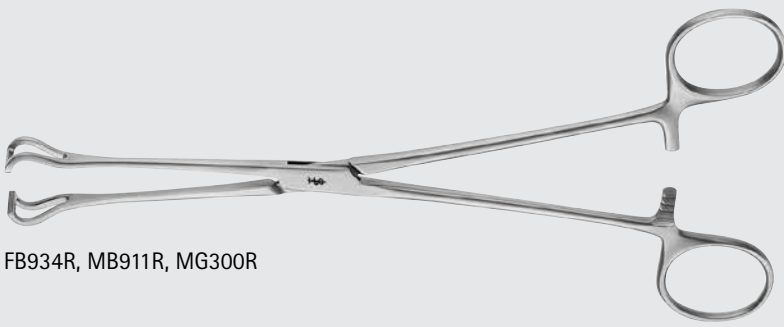

FB934R, MB911R, MG300R

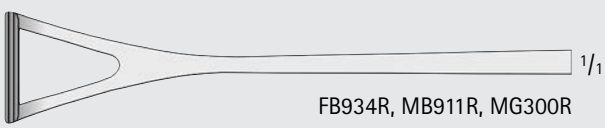

FB934R, MB911R, MG300R $\frac{1}{1}$

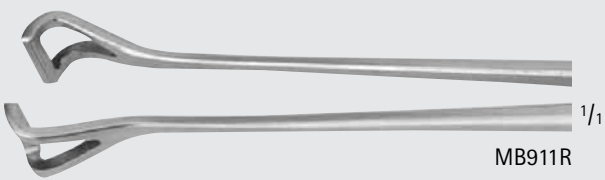

MB911R $\frac{1}{1}$

BABCOCK Forceps

Catalog Number	Tip	Length (in.)
MG359R	-	5 1/2
EA030R	-	6 1/8
EA031R	-	6 7/8
EA032R	-	8 1/2
FB934R	-	8 3/4
MB300R	-	14
MB911R	DEL, PETITE	16

General Surgery

Abdominal and Intestinal Grasping Forceps

BABCOCK Atraumatic Forceps

Catalog Number	Length (in.)
EA050R	6 1/4
EA052R	8 1/2
FB936R	8 3/4
MD470	9 1/2

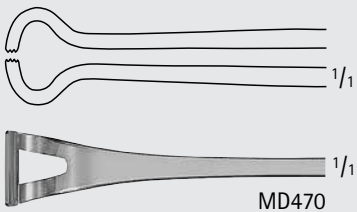
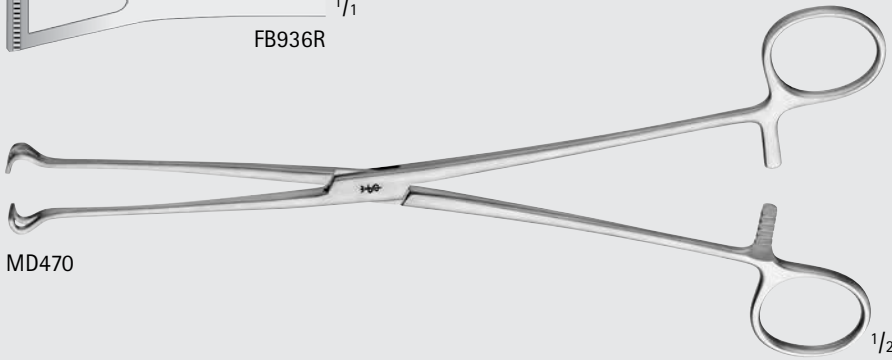
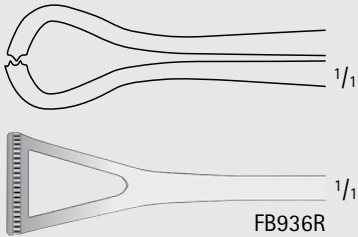
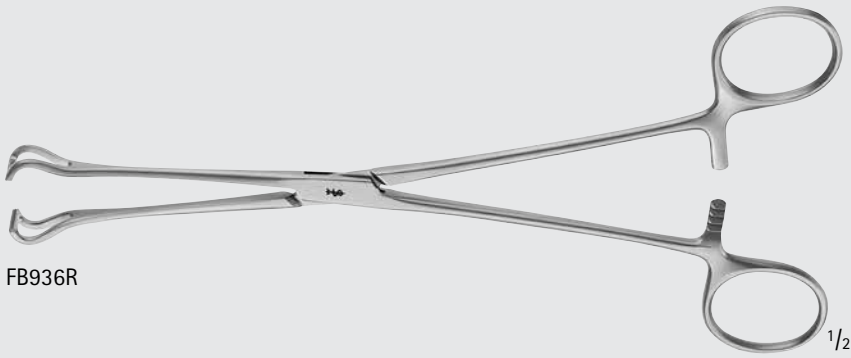
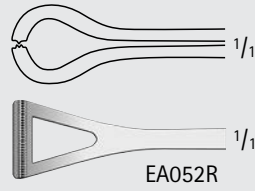
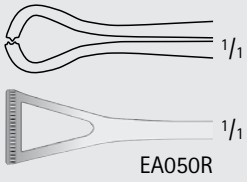
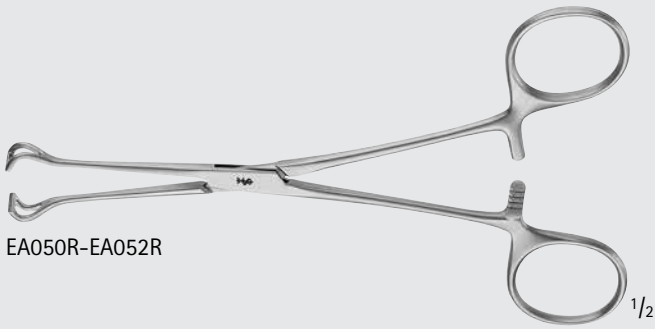

General Surgery

Abdominal and Intestinal Grasping Forceps

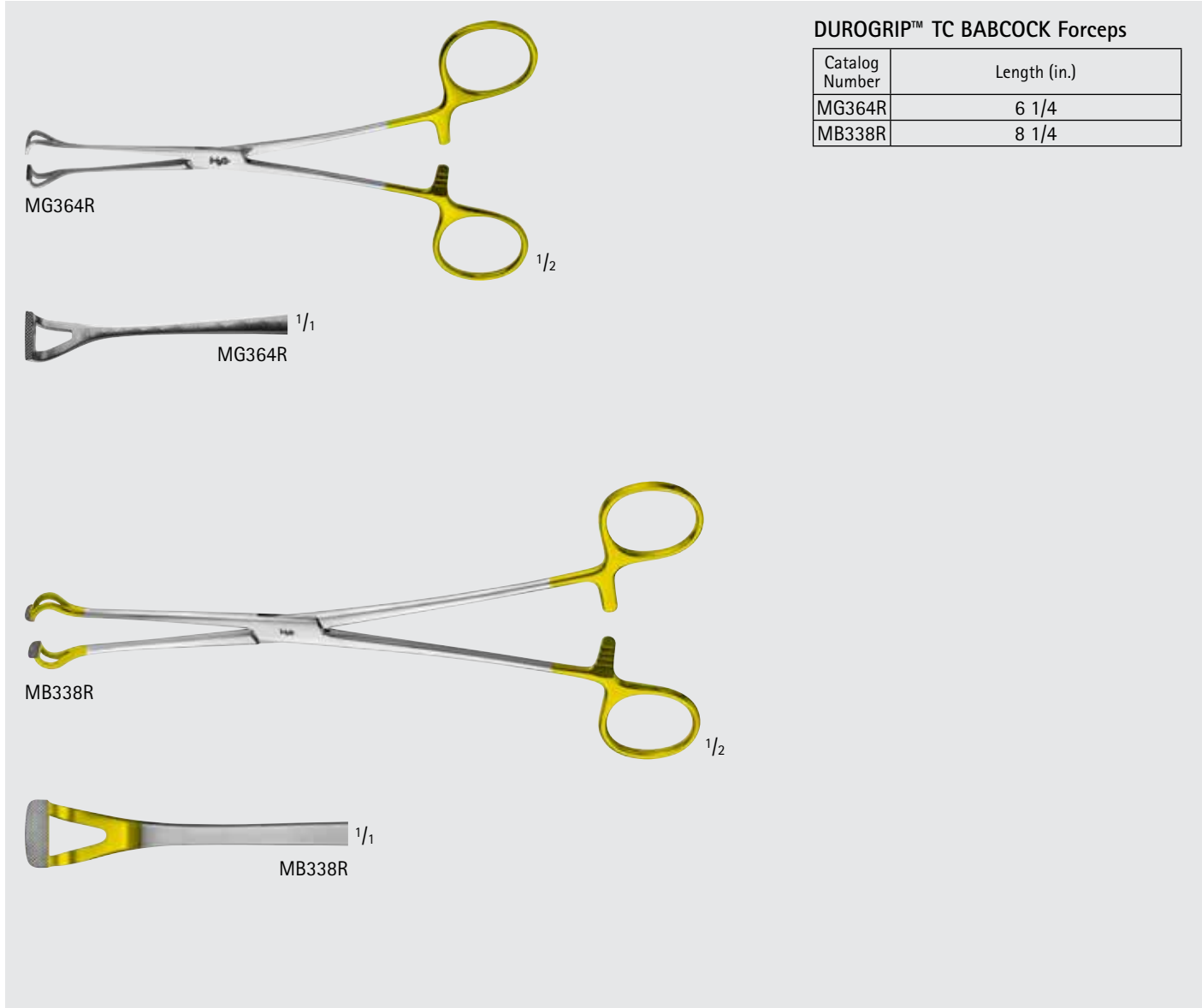

DUROGRIP™ TC BABCOCK Forceps

Catalog Number	Length (in.)
MG364R	6 1/4
MB338R	8 1/4

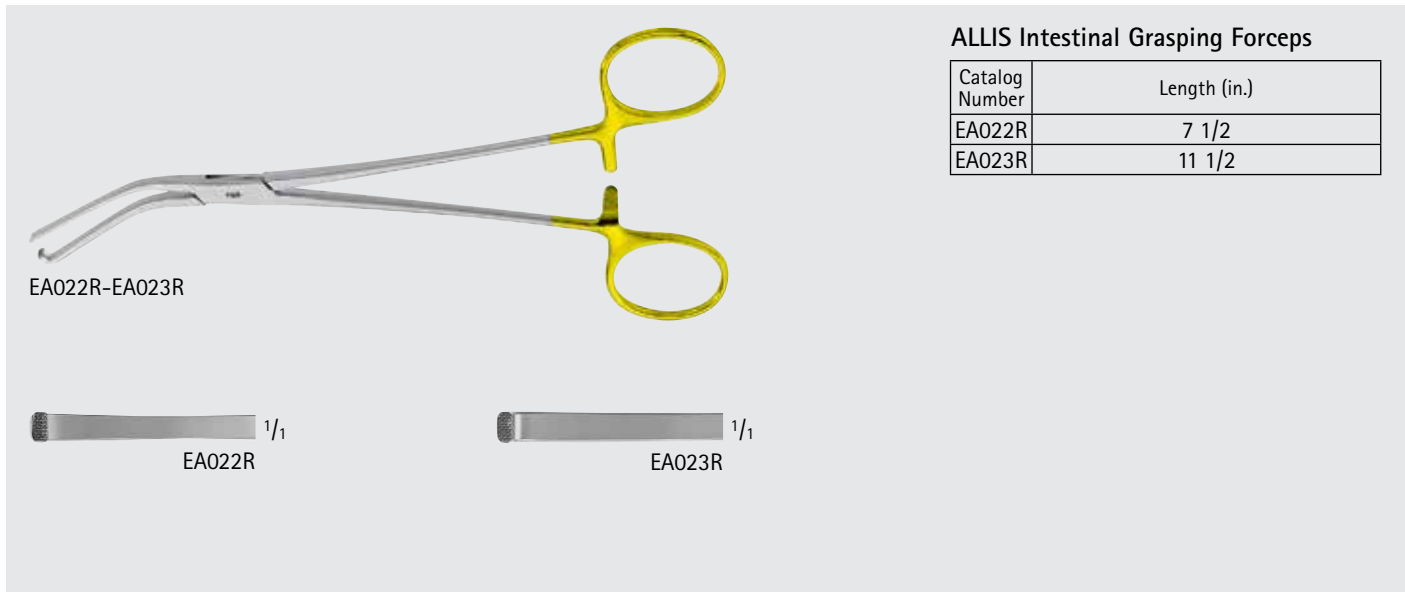

ALLIS Intestinal Grasping Forceps

Catalog Number	Length (in.)
EA022R	7 1/2
EA023R	11 1/2

COLLIN Intestinal Forceps

Catalog Number	Length (in.)
EA039R	5 1/2
EA040R	7

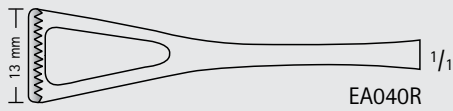
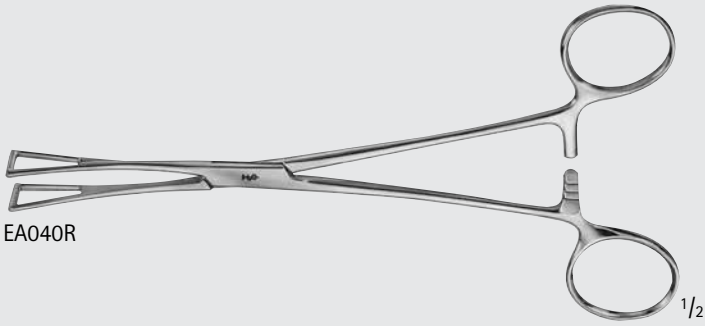
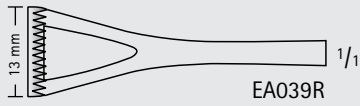
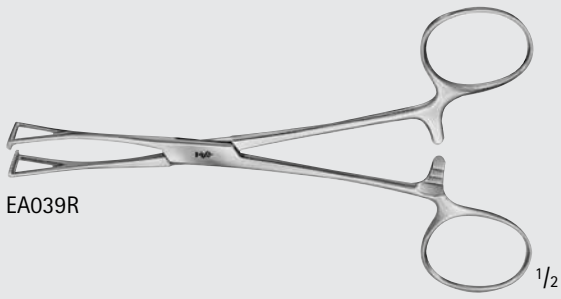

COLLIN Atraumatic Forceps

Catalog Number	Length (in.)
EA061R	7 3/4
EA062R	9

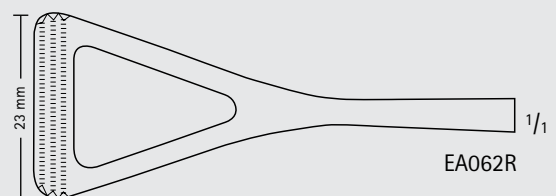
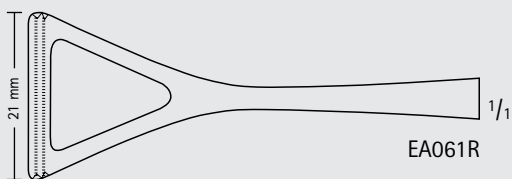
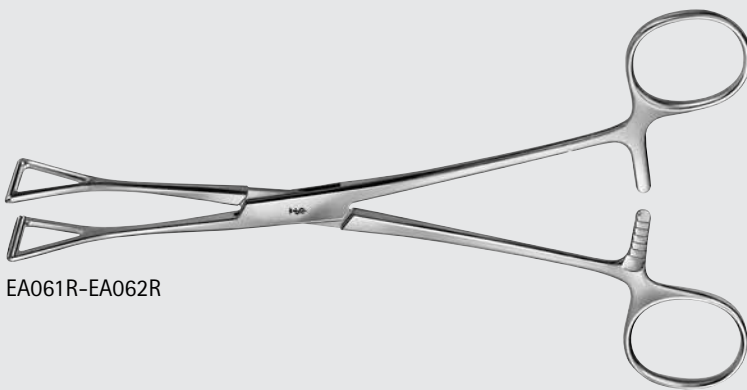

INCHES

General Surgery

Abdominal and Intestinal Grasping Forceps



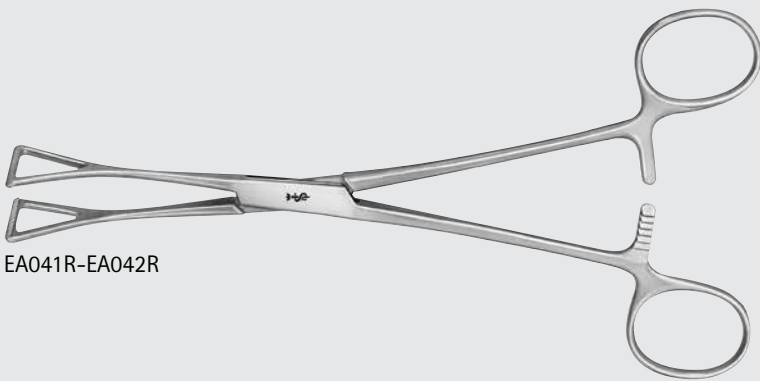

EA041R-EA042R

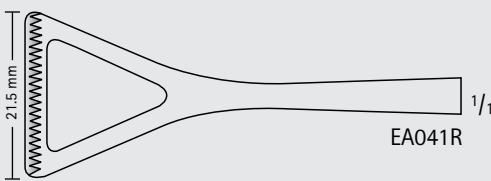

21.5 mm
EA041R

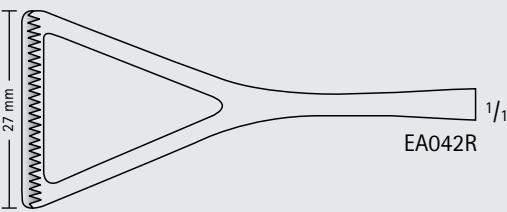

27 mm
EA042R

DUVAL-COLLIN Intestinal Forceps

Catalog Number	Length (in.)
EA041R	7 3/4
EA042R	7 7/8

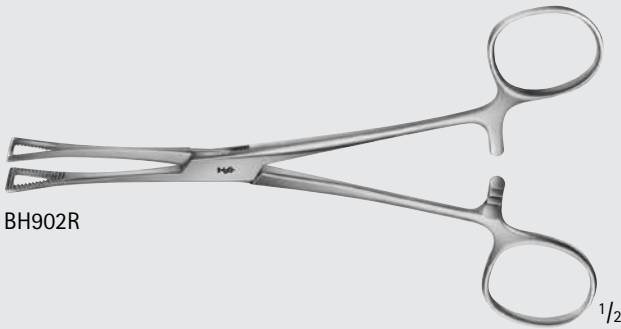

BH902R

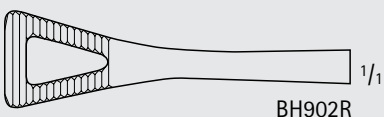

1/1
BH902R

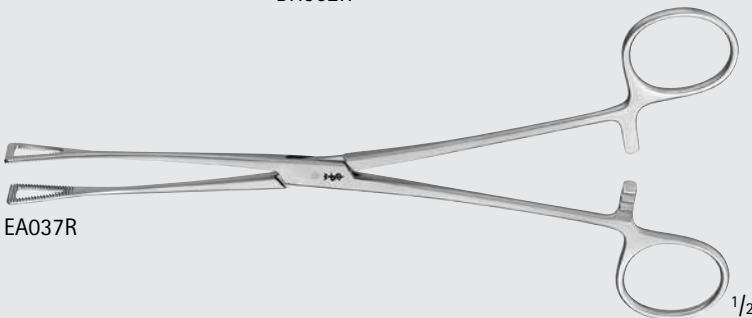

EA037R

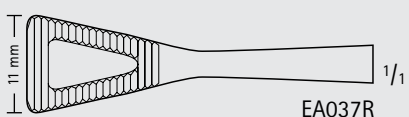

11 mm
EA037R

PENNINGTON Forceps

Catalog Number	Length (in.)
BH902R	6 1/8
EA037R	7 7/8



BAINBRIDGE Intestinal Forceps, Longitudinal Serrations

Catalog Number	Jaw	Length (in.)
EA106R	STR	6 1/8
US114	STR	7 1/4
EA107R	CVD	6 1/8
US115	CVD	7 1/4

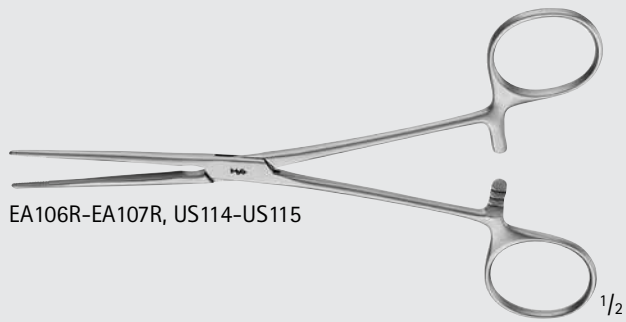

EA106R-EA107R, US114-US115



EA106R



EA107R



US114



US115

ALLEN Intestinal Forceps, Longitudinal Serrated

Catalog Number	Teeth	Length (in.)
EA114R	1 x 2	6 1/8
MB609R	1 x 2	7 7/8

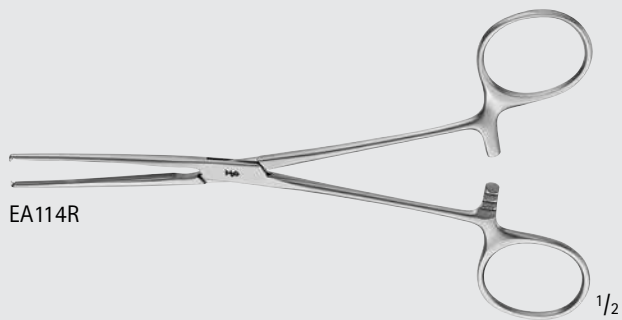

EA114R



EA114R

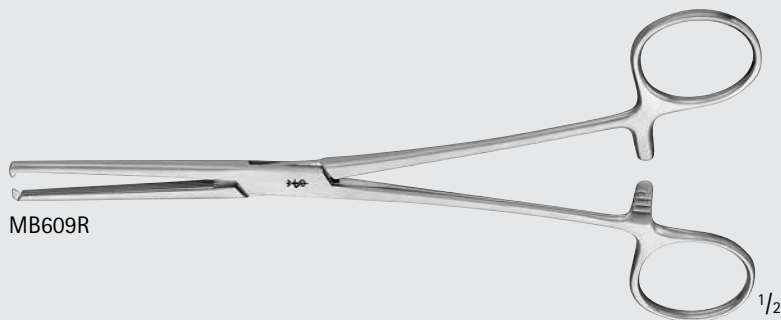

MB609R



MB609R

General Surgery

Abdominal and Intestinal Forceps

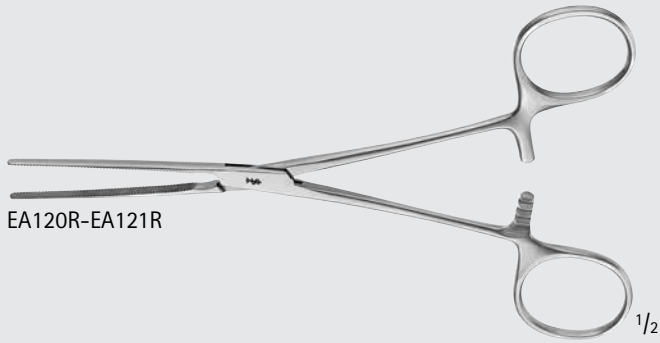

EA120R-EA121R



EA120R



EA121R

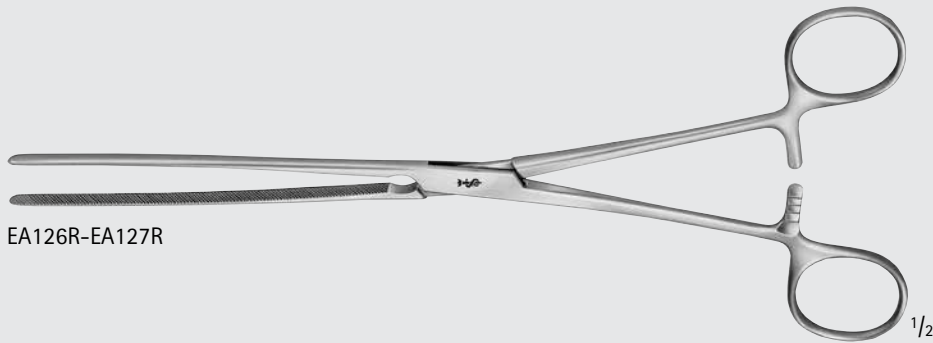

EA126R-EA127R



EA126R

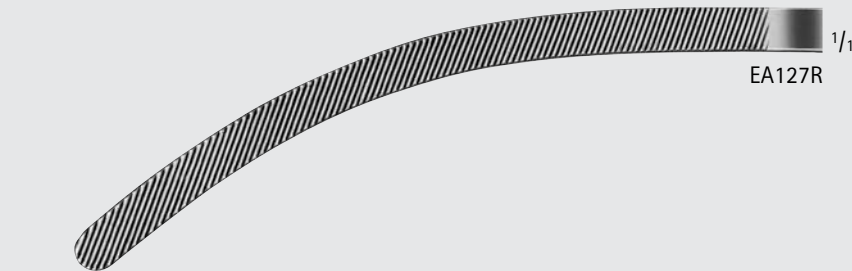

EA127R

DOYEN Intestinal Forceps, Elastic Blades

Catalog Number	Jaw	Length (in.)
EA120R	STR	6 1/2
EA126R	STR	9 1/4
EA121R	CVD	6 1/2
EA127R	CVD	9 1/4

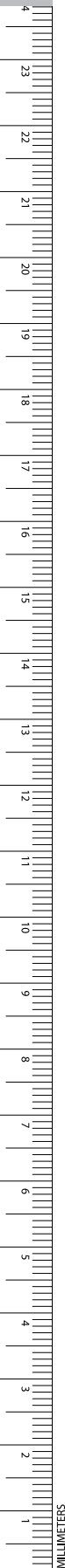

DOYEN Intestinal Forceps, Elastic Blades, Longitudinal Serations

Catalog Number	Jaw	Length (in.)
EA130R	STR	9 1/2
EA131R	CVD	9 1/2

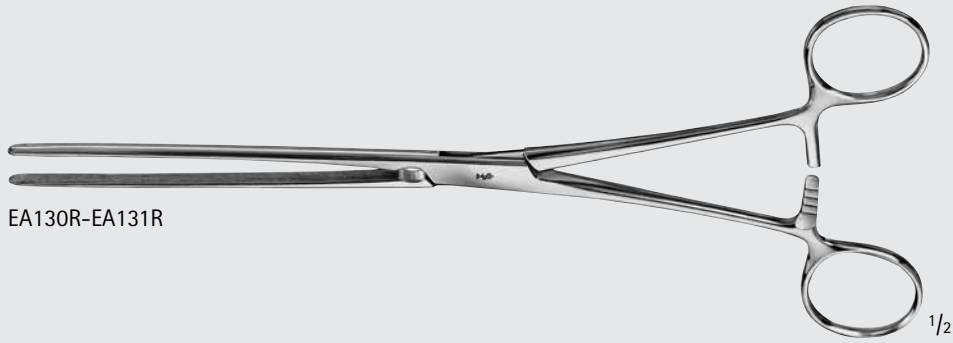

EA130R-EA131R



EA130R

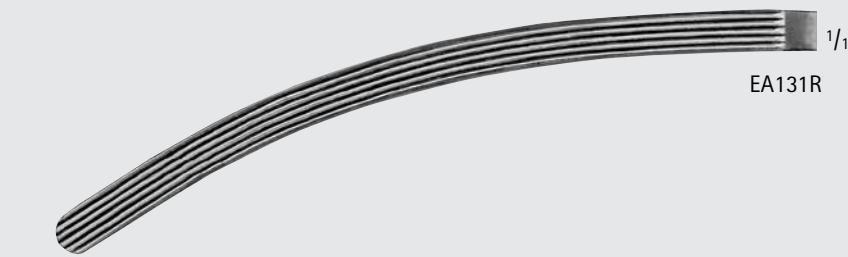

EA131R

HARTMANN Intestinal Clamp, Elastic Blades

Catalog Number	Jaw	Length (in.)
EA124R	STR	7 7/8
EA125R	CVD	7 7/8

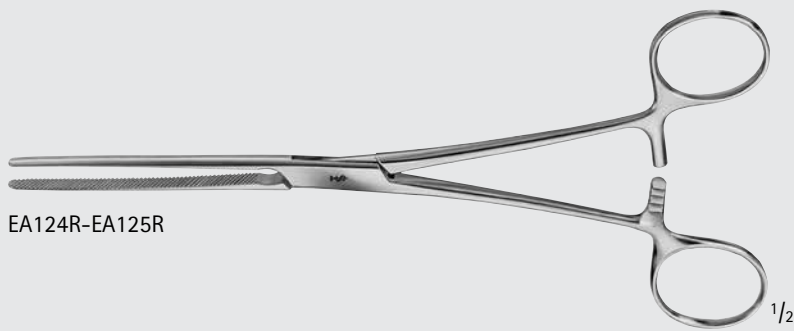

EA124R-EA125R



EA124R



EA125R



General Surgery

Abdominal and Intestinal Forceps

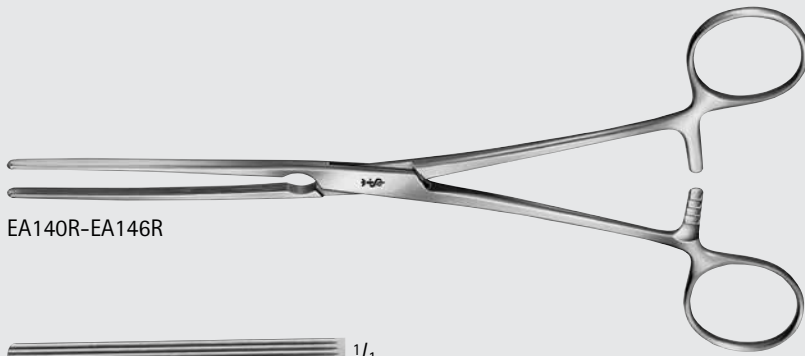

EA140R-EA146R



EA116R



EA140R



EA145R

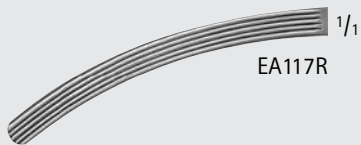

EA117R



EA141R

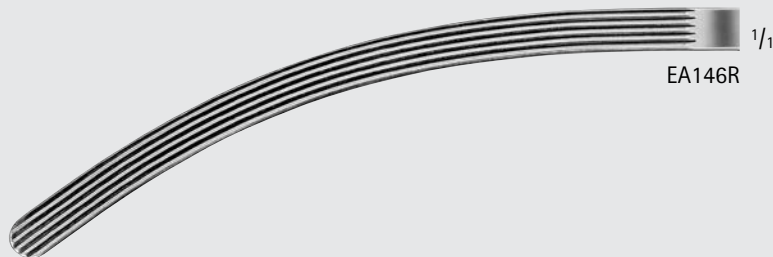

EA146R

KOCHER Intestinal Forceps, Elastic Blades

Catalog Number	Jaw	Length (in.)
EA116R	STR	6 1/8
EA140R	STR	8 1/4
EA145R	STR	9
EA117R	CVD	5 1/4
EA141R	CVD	8 1/4
EA146R	CVD	9

KOCHER Intestinal Forceps, Elastic
Blades

Catalog Number	Jaw	Length (in.)
EA150R	STR	8 3/4
EA151R	STR	9 3/4
EA152R	STR	11
EA155R	CVD	8 3/4
EA156R	CVD	9 3/4

EA150R-EA156R

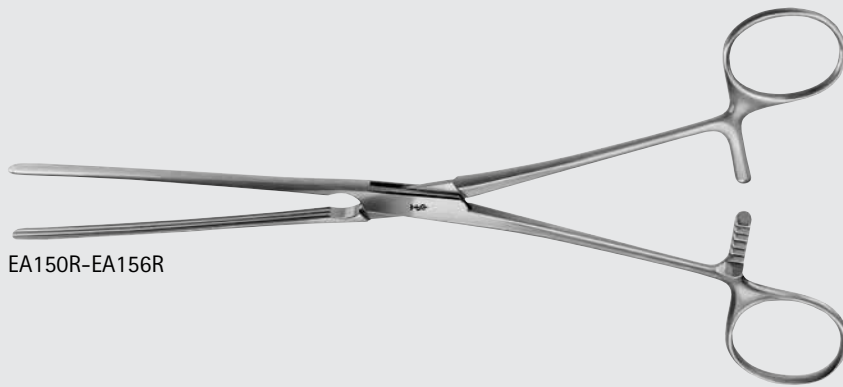

INCHES

General Surgery

Abdominal and Intestinal Forceps



MAYO-ROBSON Intestinal Forceps,
Hard Elastic Blades

Catalog Number	Jaw	Length (in.)
EA170R	STR	9 3/4
EA171R	CVD	9 3/4

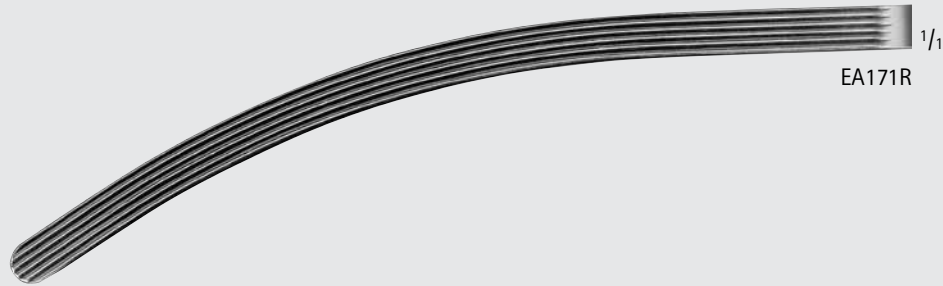
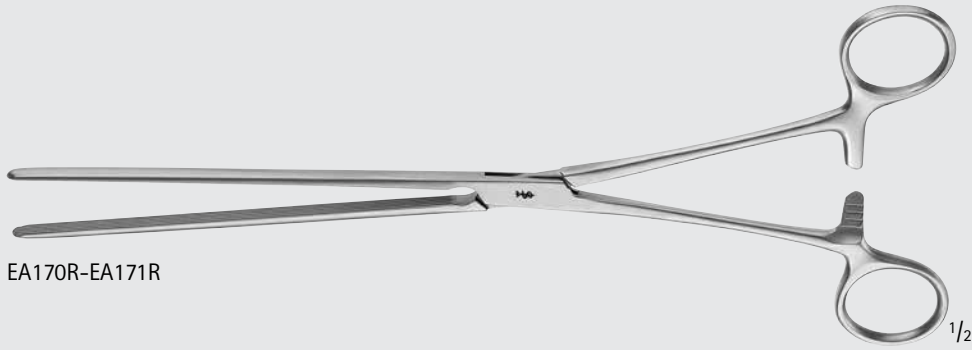

General Surgery

Abdominal and Intestinal Forceps

GENERAL SURGERY



EA305R-EA450R

PAYR Intestinal Clamp

Catalog Number	Length (in.)
EA305R	7
EA306R	7 7/8
EA309R	10 3/4
EA450R	12 1/2

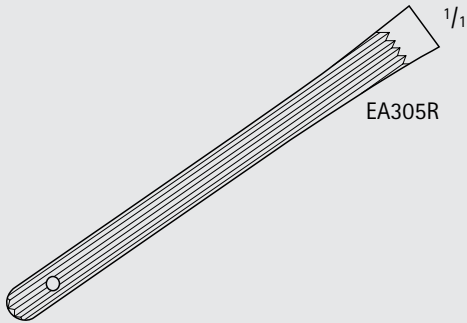

EA305R

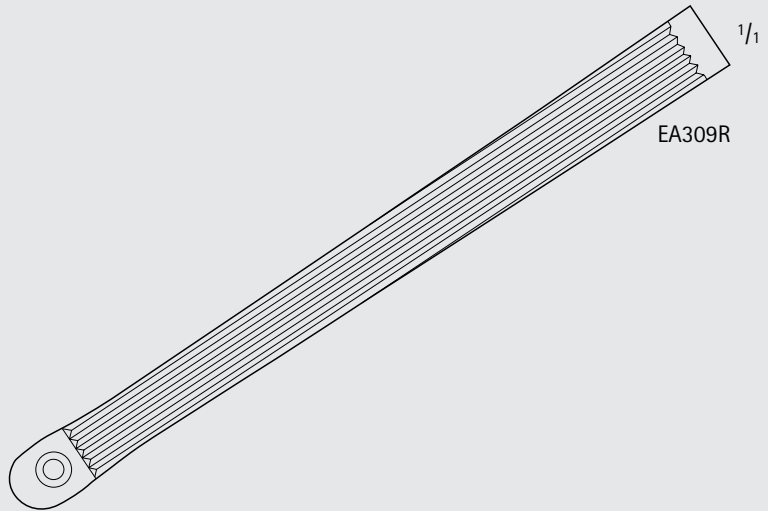

EA309R

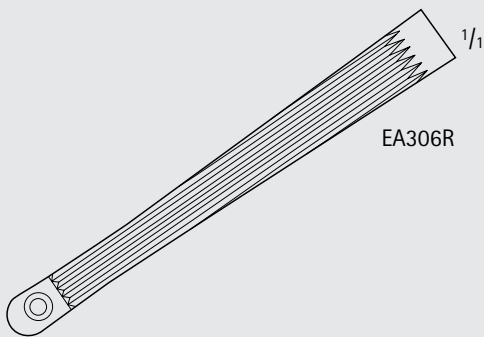

EA306R

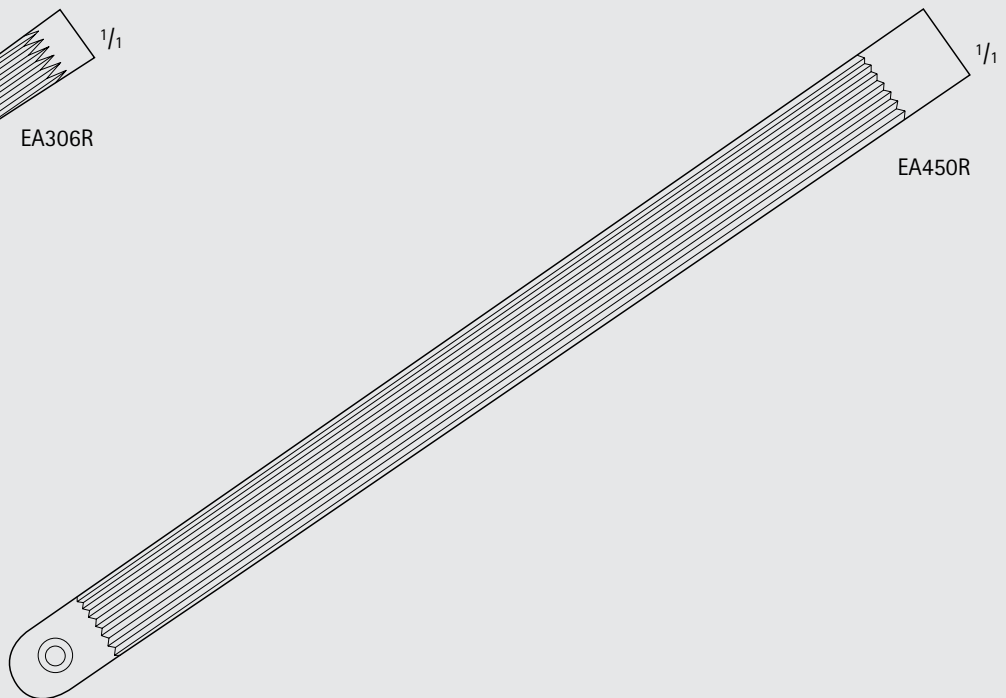

EA450R



General Surgery

Abdominal and Intestinal Forceps

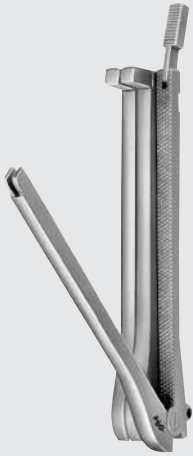

EA331R-EA332R

DEMARTEL-WOLFSON Anastomosis Clamp

Catalog Number	Description	Length (in.)
EA331R	SET OF 3	4
EA332R	SET OF 3	4 3/4



EA334R

Clamp Holder for Anastomosis Clamp

Catalog Number	Description	Length (in.)
EA334R	3" FOR USE WITH EA331R-EA332R	3 1/8

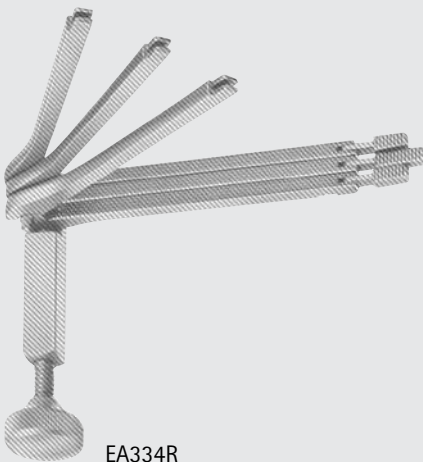

EA334R



General Surgery

Abdominal and Intestinal Forceps

GENERAL SURGERY

KLEINSCHMIDT Appendectomy Forceps

Catalog Number	Jaw	Length (in.)
EA397R	CVD	5 1/8



BENSON Pylorus Spreader

Catalog Number	Length (in.)
EA466R	6 1/8

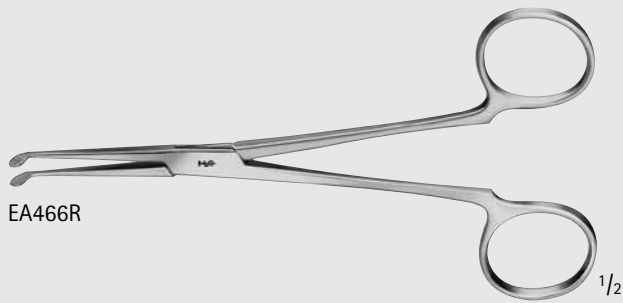

TAUFIC Cholangiography Clamp

Catalog Number	Length (in.)
MG454R	8 1/2

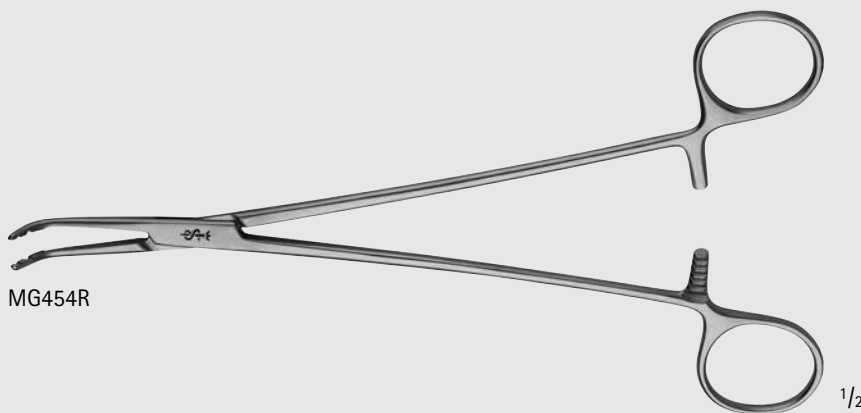

INCHES

General Surgery

Abdominal and Intestinal Forceps

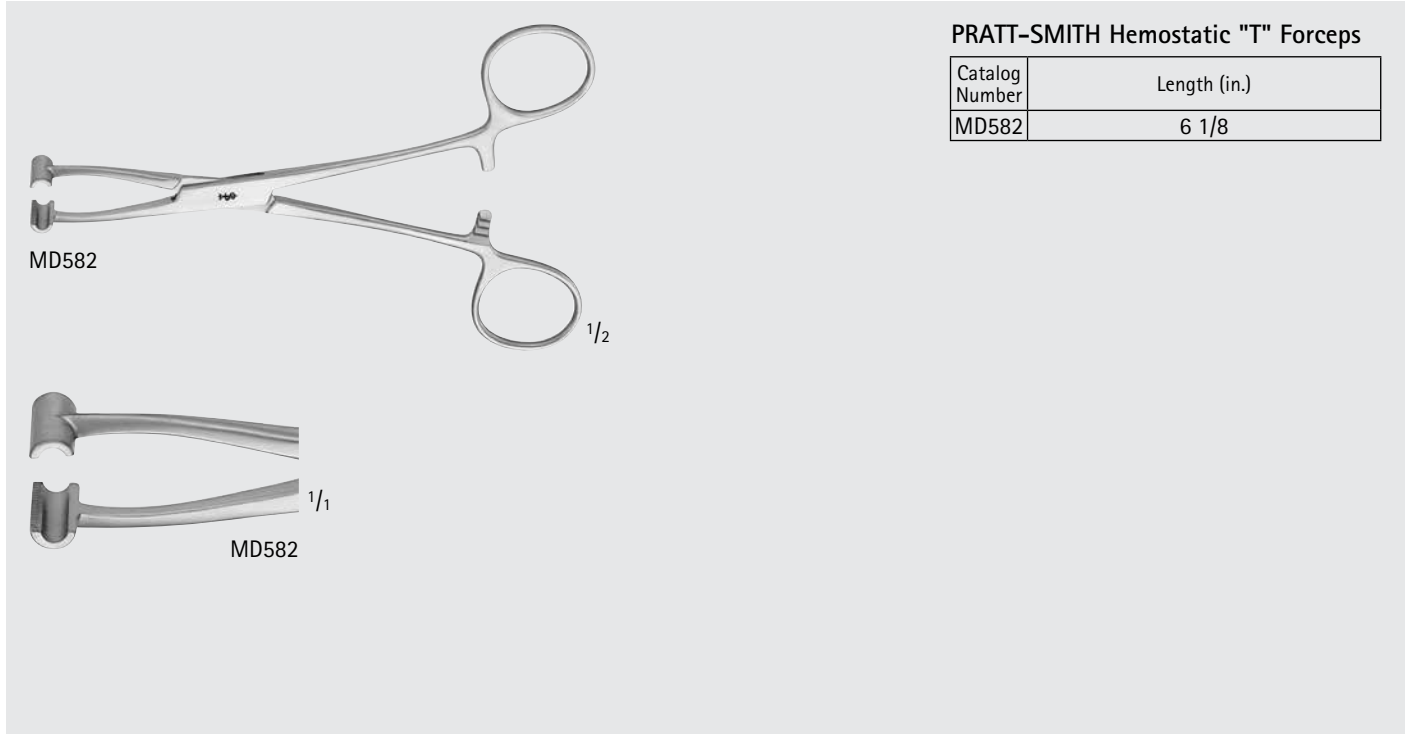

PRATT-SMITH Hemostatic "T" Forceps

Catalog Number	Length (in.)
MD582	6 1/8

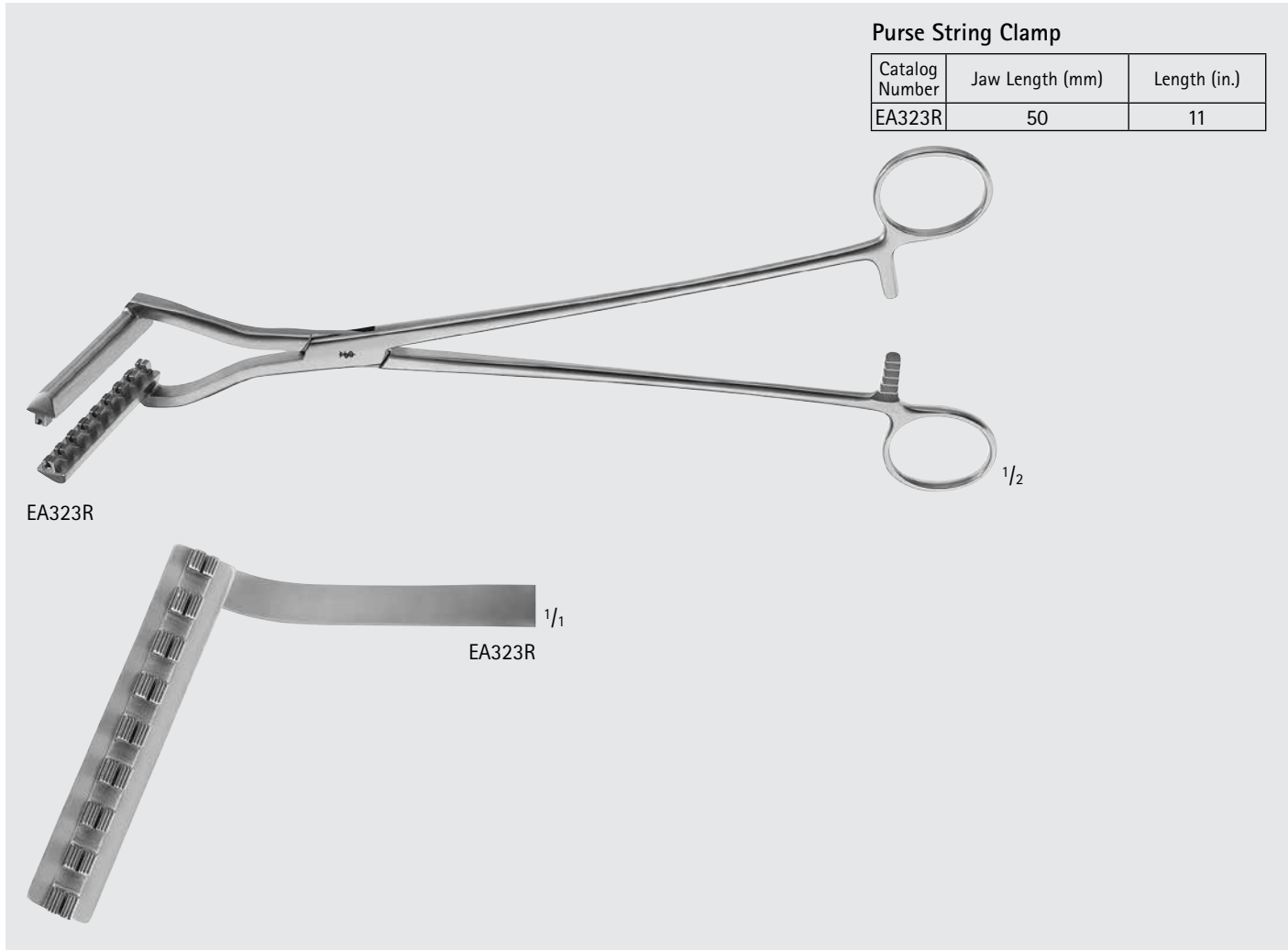

Purse String Clamp

Catalog Number	Jaw Length (mm)	Length (in.)
EA323R	50	11

General Surgery

Abdominal and Intestinal Forceps

GENERAL SURGERY

LOWER Gall Duct Forceps

Catalog Number	Jaw	Length (in.)
EB001R	HEAVY-CVD	7

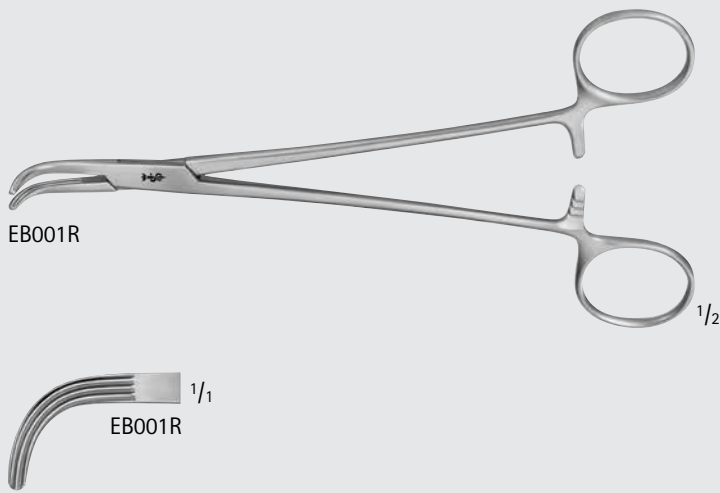

LAHEY (SWEET) Gall Duct Forceps

Catalog Number	Jaw	Length (in.)
EB003R	CVD	7 $\frac{7}{8}$

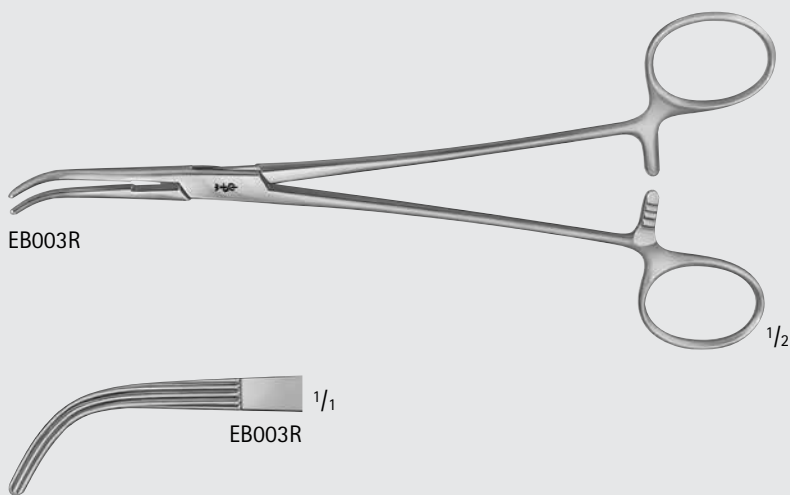

DESJARDINS Gall Duct Forceps

Catalog Number	Jaw	Length (in.)
EB008R	HEAVY-CVD	8 $\frac{3}{4}$

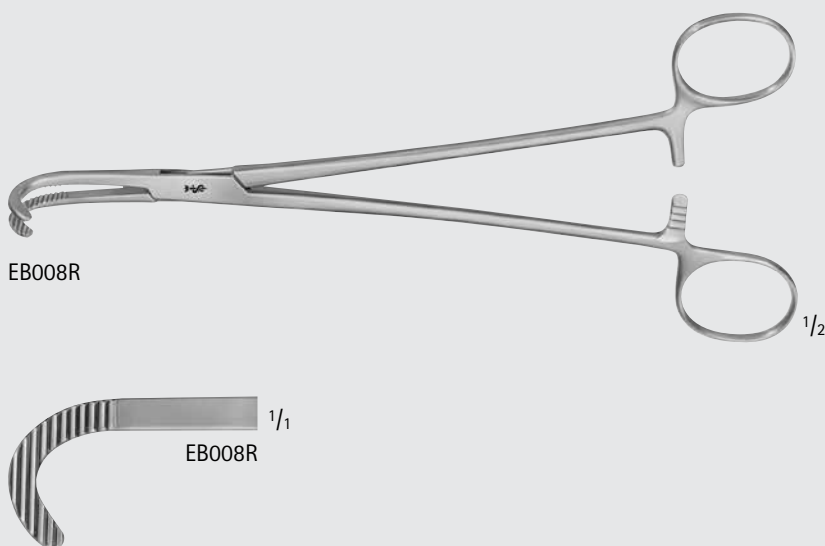

INCHES

General Surgery

Abdominal and Intestinal Forceps

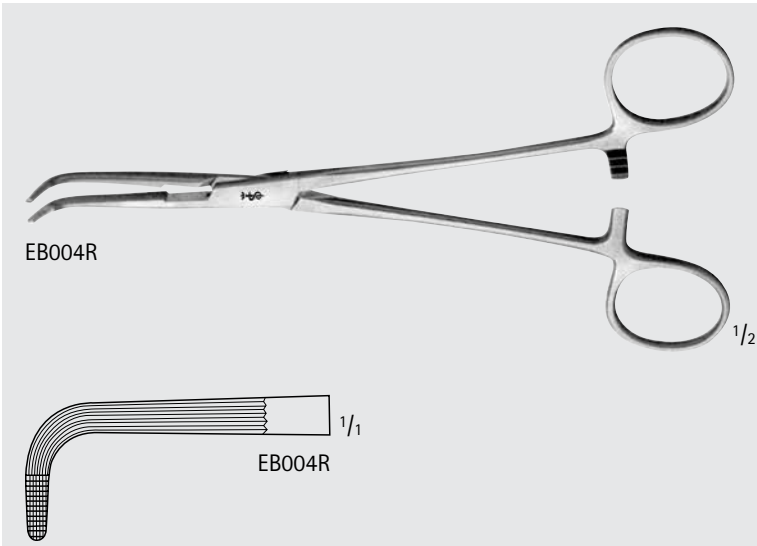

LAHEY Gall Duct Forceps

Catalog Number	Jaw	Length (in.)
EB004R	HEAVY-CVD	7 1/2

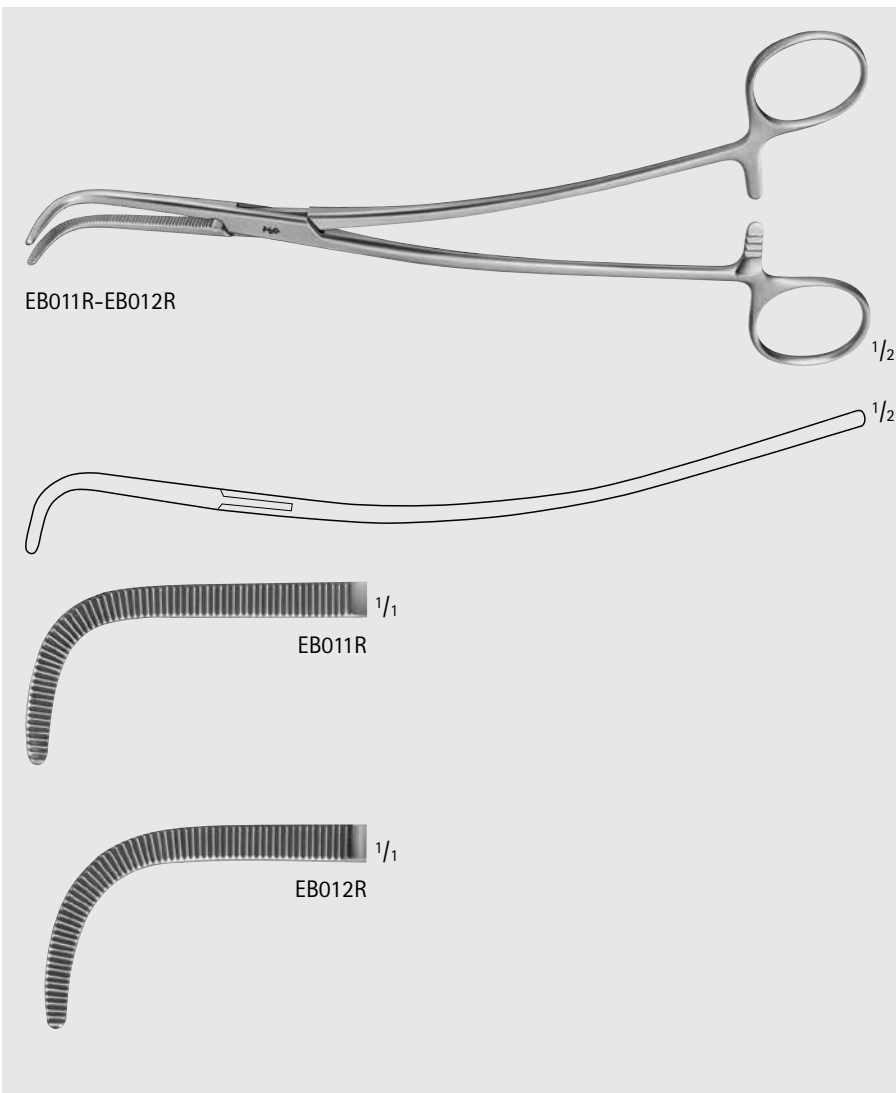

GRAY Cystic Gall Duct Forceps

Catalog Number	Jaw	Length (in.)
EB011R	SHORT, CVD	8 3/4
EB012R	LONG, CVD	8 3/4

MIXTER Gall Duct Forceps

Catalog Number	Jaw	Length (in.)
MB120R	HEAVY-CVD	6 1/4

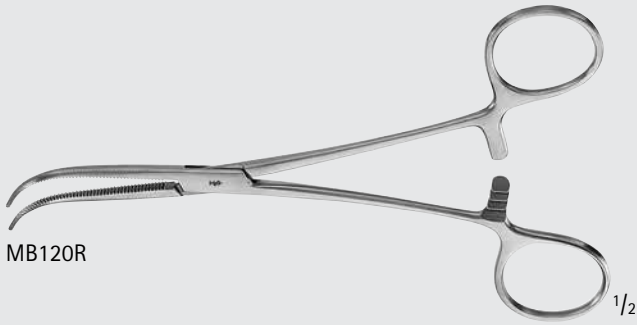

MB120R

1/2



MB120R

1/1

SHALLCROSS Cystic Duct Forceps

Catalog Number	Jaw	Length (in.)
MB126R	CVD	6 7/8
US152	FULL-CVD	8

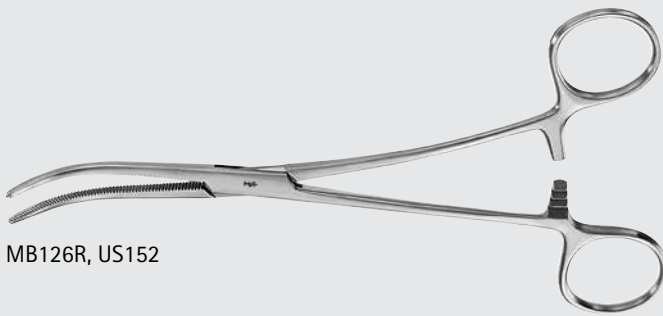

MB126R, US152



MB126R

1/1

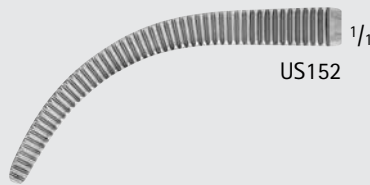

US152

1/1

BLAKE Gall Stone Forceps

Catalog Number	Jaw	Length (in.)
EB220R	STR	8
EB221R	CVD	8

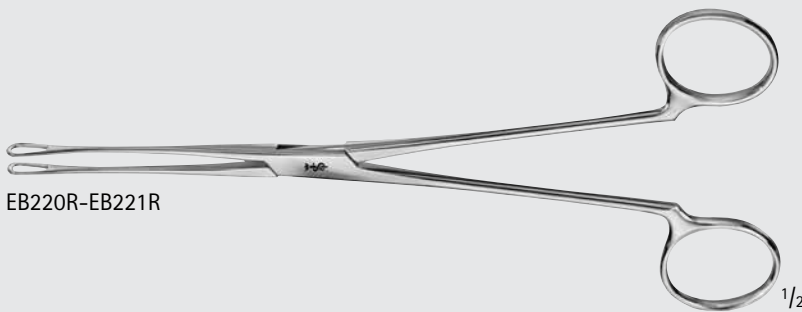

EB220R-EB221R

1/2



EB220R

1/1

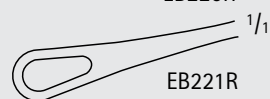

EB221R

1/1



INCHES

General Surgery

Abdominal and Intestinal Forceps

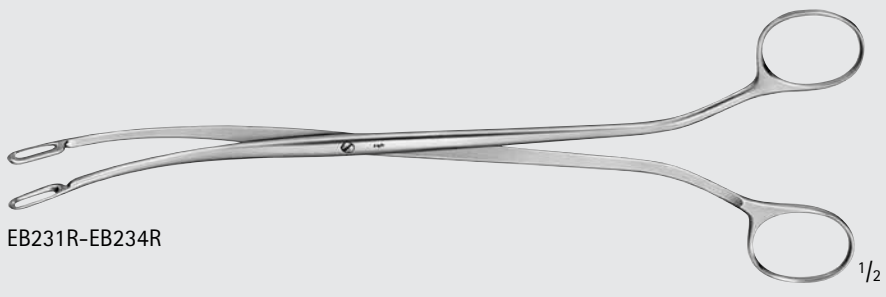

EB231R-EB234R

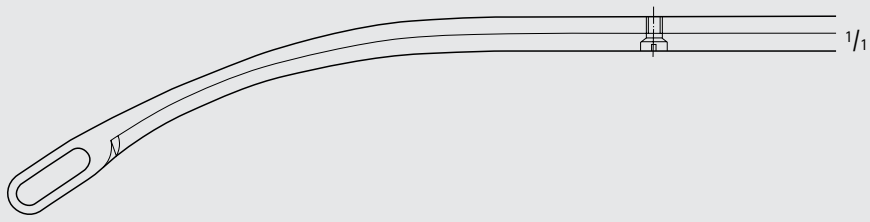

DESJARDINS Gall Stone Forceps

Catalog Number	Tip	Length (in.)
EB231R	OVAL	8 7/8
EB232R	OVAL	8 7/8
EB233R	TAPERED	8 7/8
EB234R	TAPERED	8 7/8



EB231R



EB232R



EB233R



EB234R

PARKER-KERR Forceps

Catalog Number	Jaw	Length (in.)
EA365R	SLIGHT-CVD	9 3/4



HEIMING Kidney Stone Forceps

Catalog Number	Jaw	Length (in.)
EF047R	SLIGHT-CVD	6 3/4
EF048R	HEAVY-CVD	6 1/4

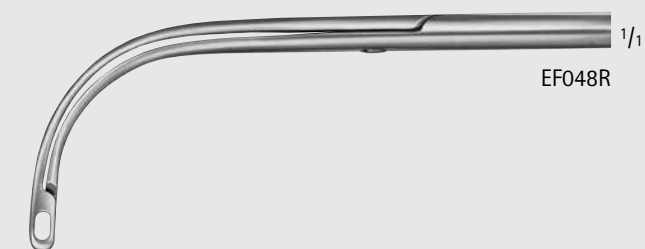
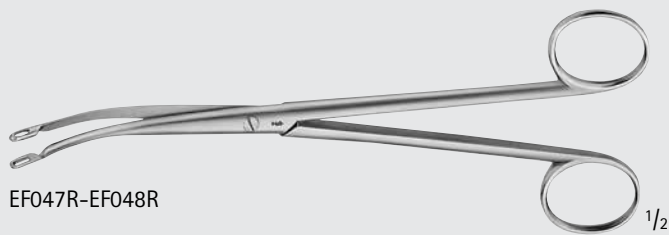

General Surgery

Abdominal and Intestinal Forceps

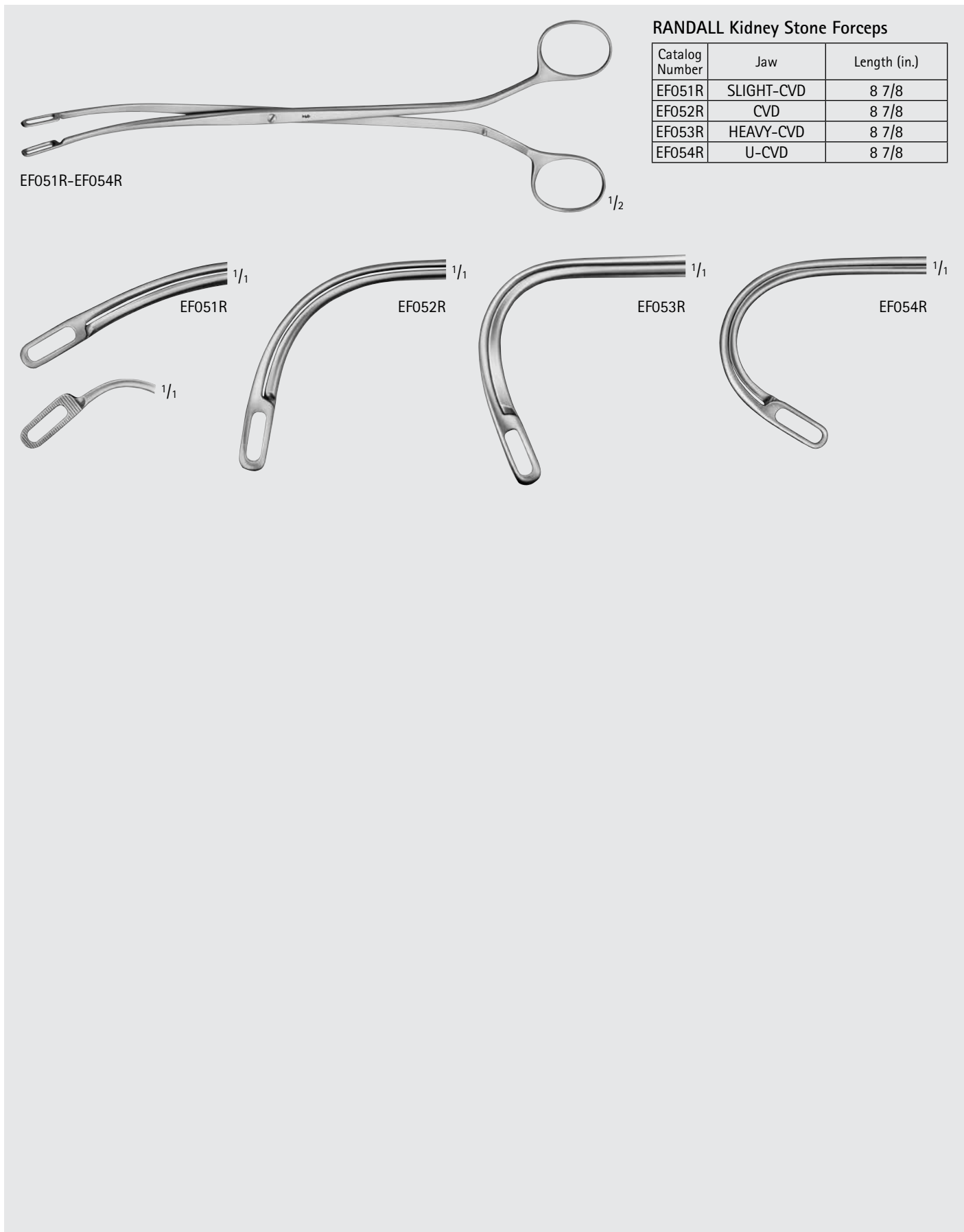

RANDALL Kidney Stone Forceps

Catalog Number	Jaw	Length (in.)
EF051R	SLIGHT-CVD	8 7/8
EF052R	CVD	8 7/8
EF053R	HEAVY-CVD	8 7/8
EF054R	U-CVD	8 7/8

EF051R-EF054R

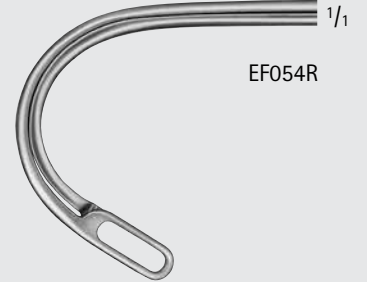
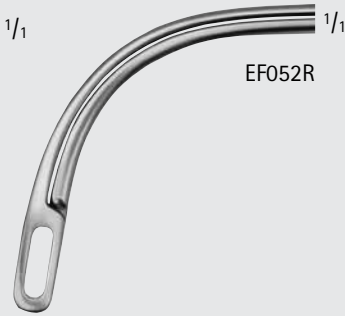

RANDALL Kidney Stone Forceps
(continued)

Catalog Number	Jaw	Length (in.)
EF055R	CVD	7 1/2
EF056R	HEAVY-CVD	7 1/2
EB244R	90° ANG	9 5/8
EB246R	HEAVY-CVD, DEL	9

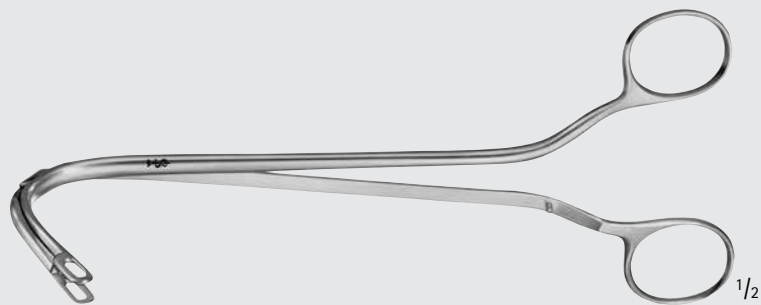

EF055R-EF056R

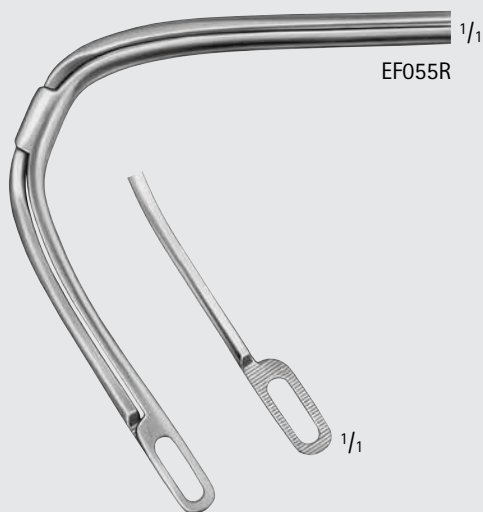

EF055R

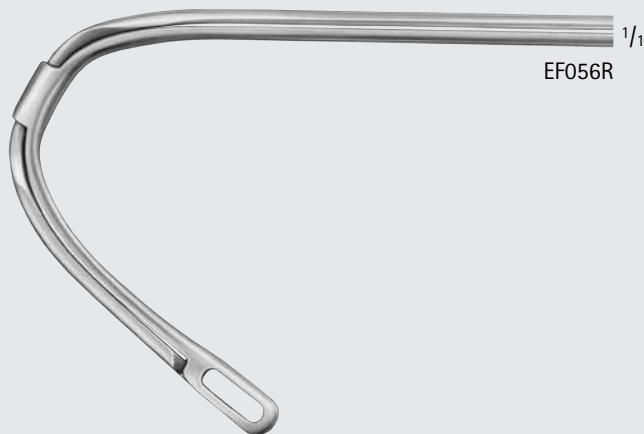

EF056R

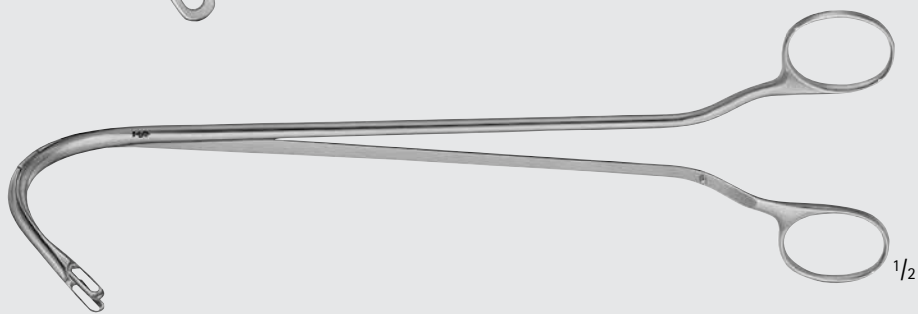

EB244R



EB244R



EB246R

General Surgery

Atraumatic Intestinal Forceps and Clamps

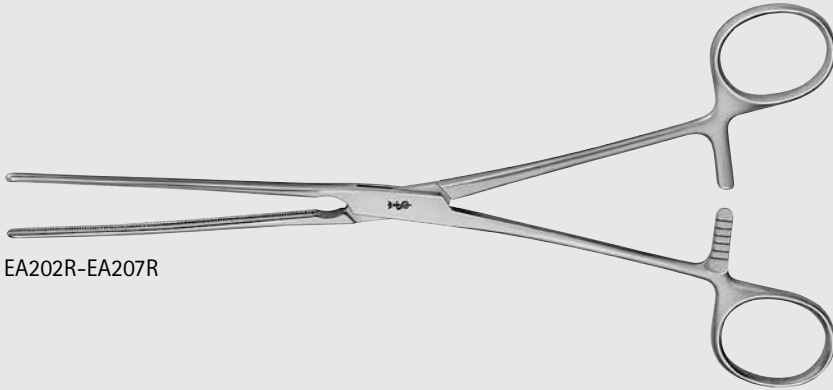

EA202R-EA207R

**KOCHER Atraumatic Forceps,
Elastic Blades**

Catalog Number	Jaw	Length (in.)
EA202R	STR	8 3/4
EA204R	STR	9 3/4
EA206R	STR	11
EA203R	CVD	8 3/4
EA205R	CVD	9 3/4
EA207R	CVD	11



EA202R



EA204R



EA206R

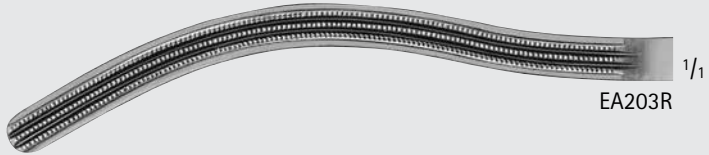

EA203R



EA205R



EA207R

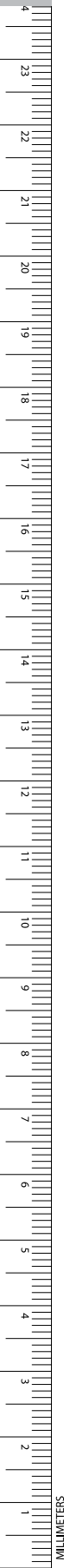

General Surgery

Atraumatic Intestinal Forceps and Clamps

HARTMANN Atraumatic Forceps, Elastic Blades

Catalog Number	Jaw	Length (in.)
EA210R	STR	7 7/8
EA211R	CVD	7 7/8

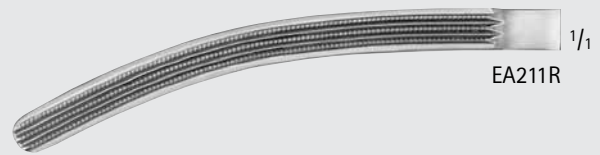
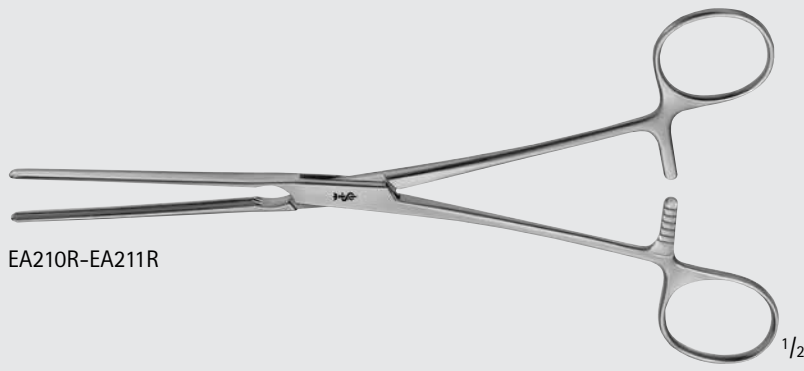

MAYO-ROBSON Atraumatic Forceps

Catalog Number	Jaw	Length (in.)
EA216R	STR	9 3/4
EA217R	CVD	9 3/4

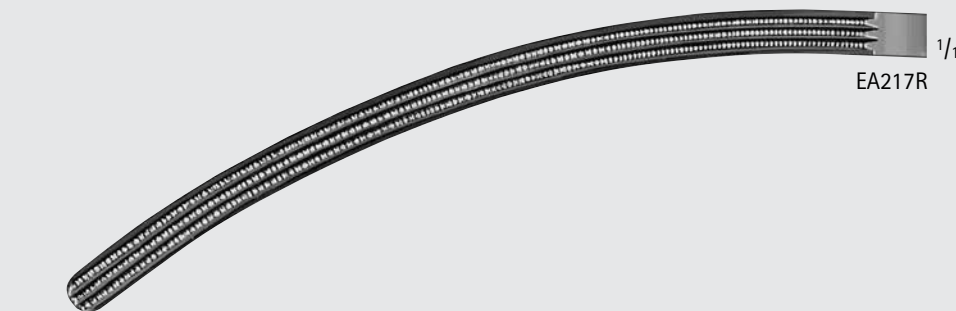
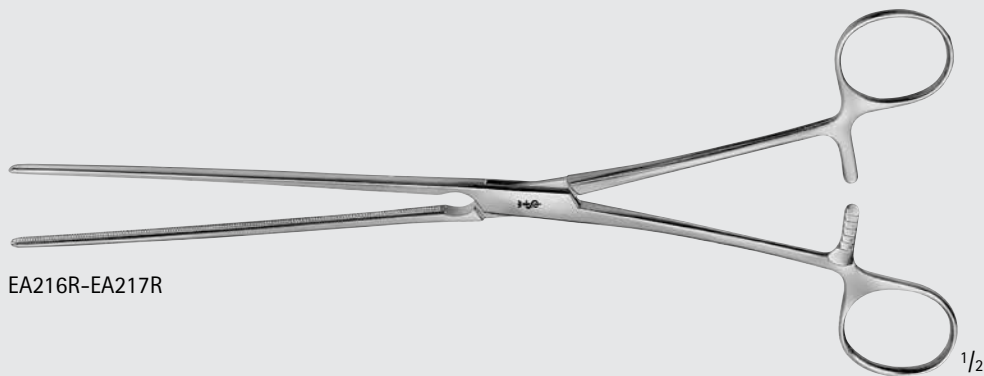

General Surgery

Atraumatic Intestinal Forceps and Clamps

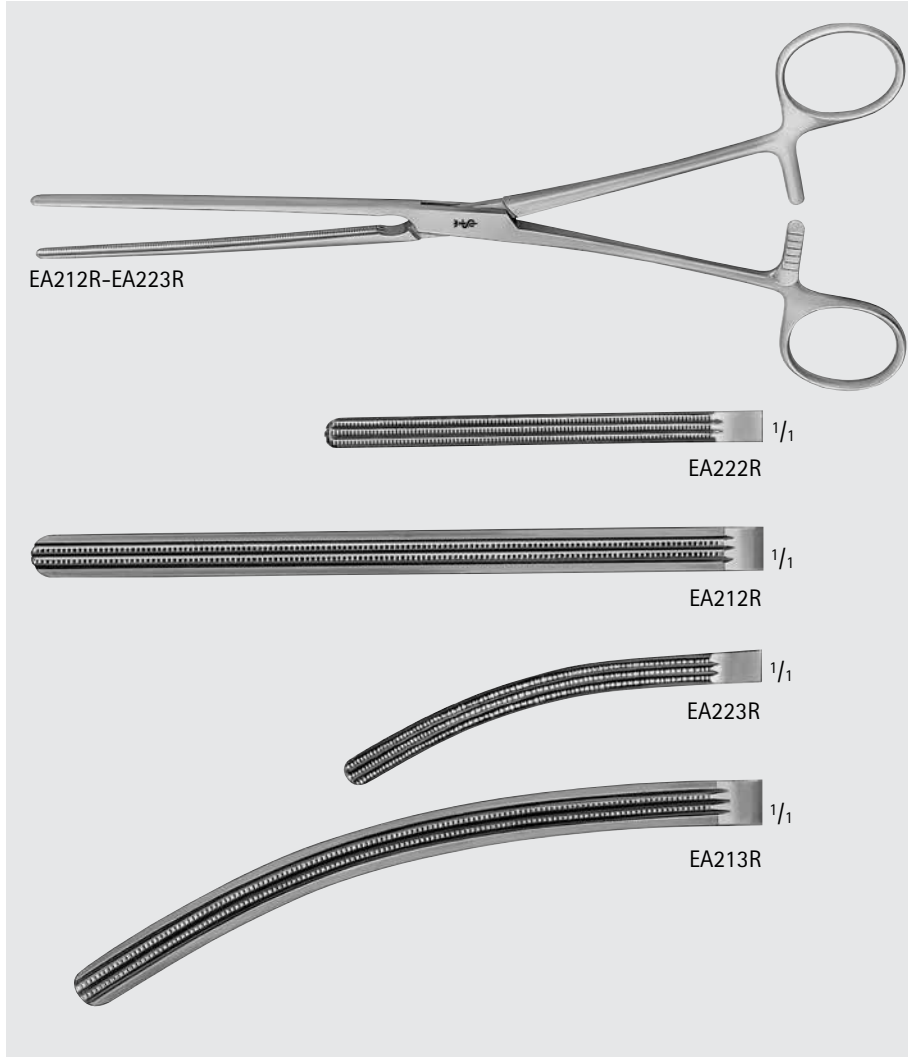

DOYEN Atraumatic Forceps, Elastic Blades

Catalog Number	Jaw	Length (in.)
EA222R	STR	6 3/4
EA212R	STR	9
EA223R	CVD	6 3/4
EA213R	CVD	9

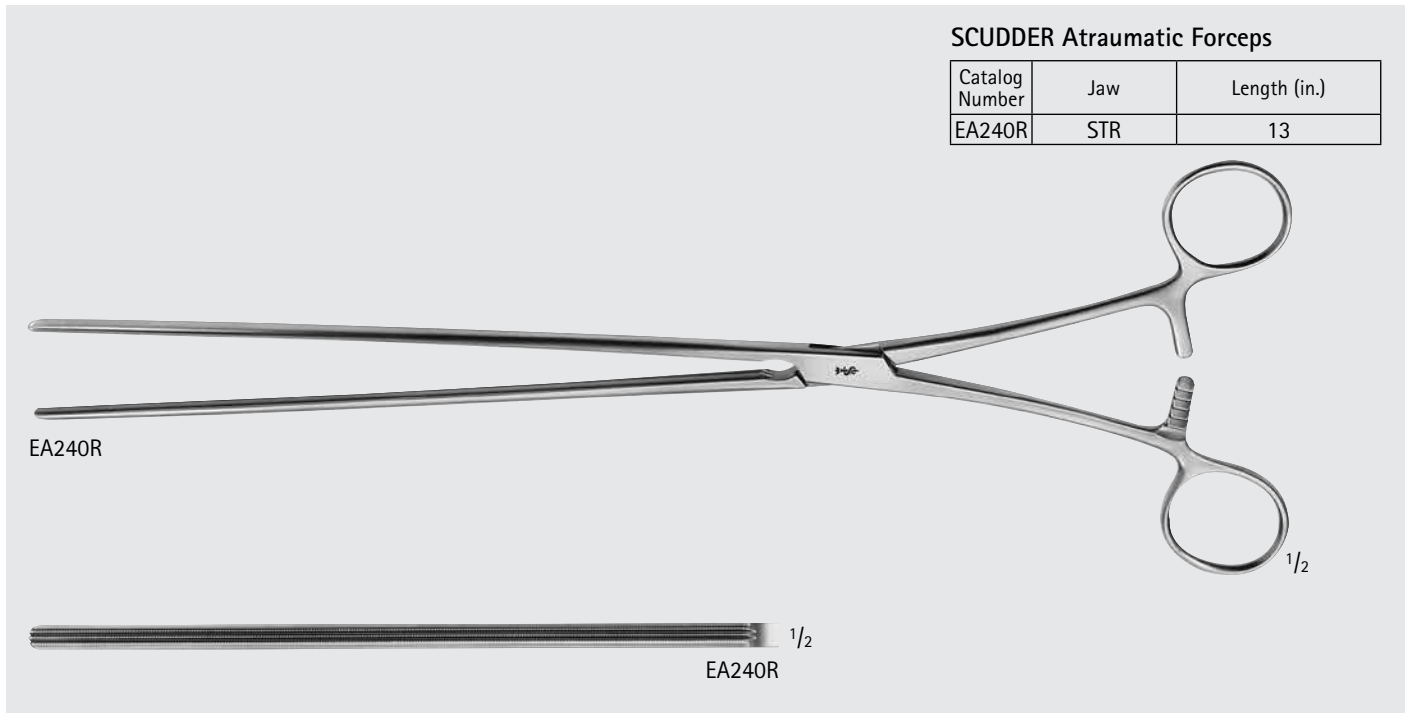

SCUDDER Atraumatic Forceps

Catalog Number	Jaw	Length (in.)
EA240R	STR	13

General Surgery

Atraumatic Intestinal Forceps and Clamps

GLASSMAN Anterior Resection Clamp

Catalog Number	Jaw	Jaw Length (mm)	Length (in.)
MB931R	90°, SERR	25	9 3/4
MB130R	90°, SERR	50	9 3/4
MB932R	90°, SERR	75	10

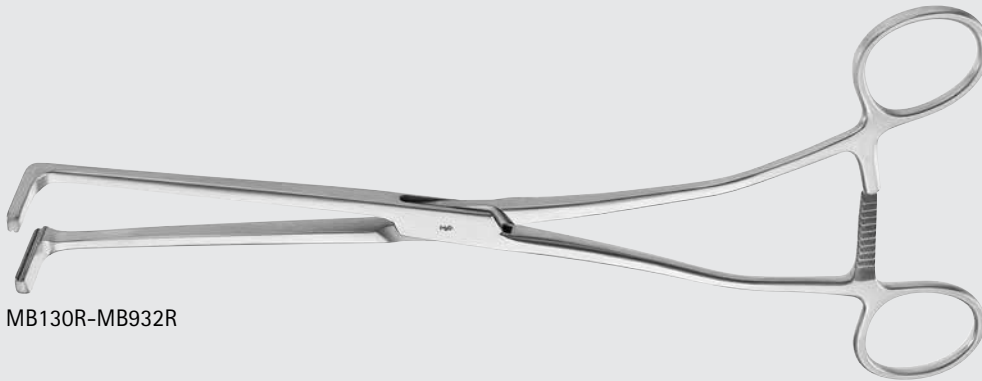

MB130R-MB932R

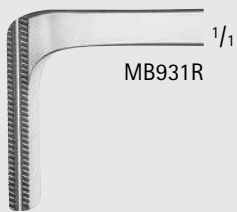

MB931R

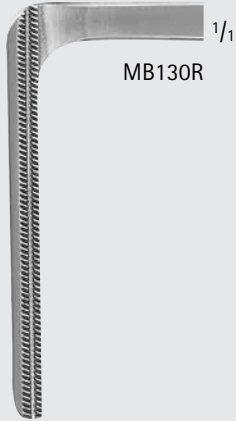

MB130R

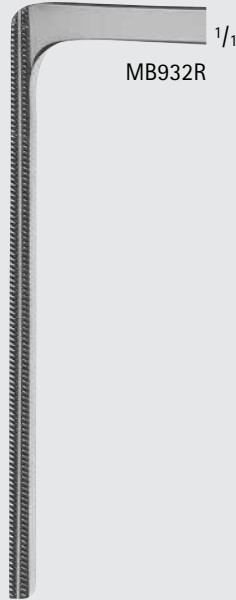

MB932R



General Surgery

Atraumatic Intestinal Forceps and Clamps

CARTER-GLASSMAN Resection Clamp

Catalog Number	Jaw	Jaw Length (mm)	Length (in.)
MG460R	STR	110	11
MG439R	45° ANG	103	10 1/4

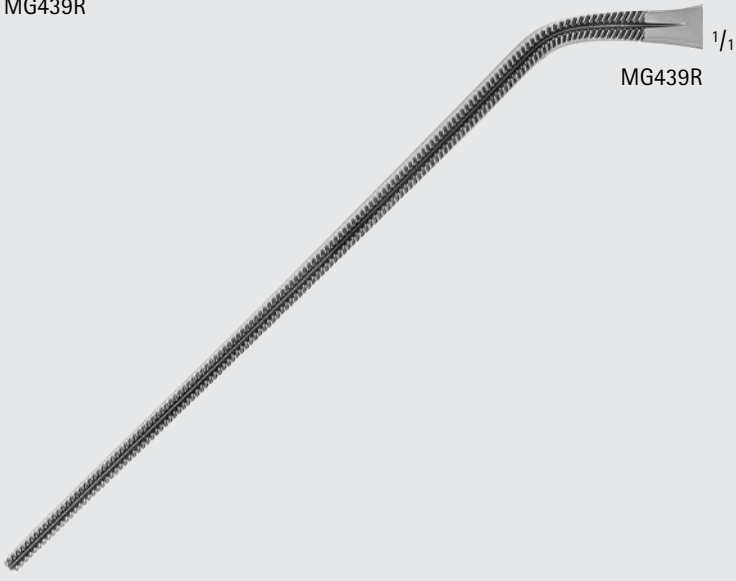
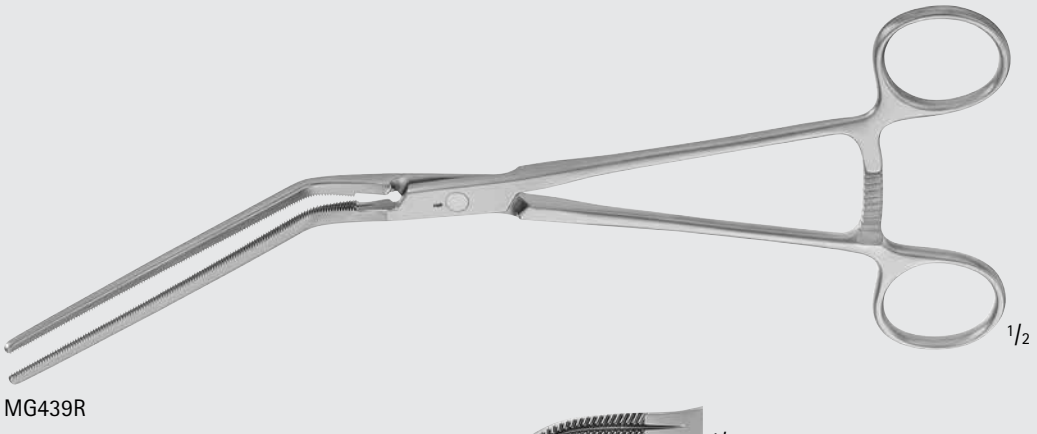

General Surgery

Atraumatic Intestinal Forceps and Clamps

GLASSMAN Intestinal and Liver Holding Clamp, Non-Crushing

Catalog Number	Jaw	Length (in.)
MG436R	STR	9 3/4
MG437R	CVD	9 5/8
MG438R	FULL CVD	9

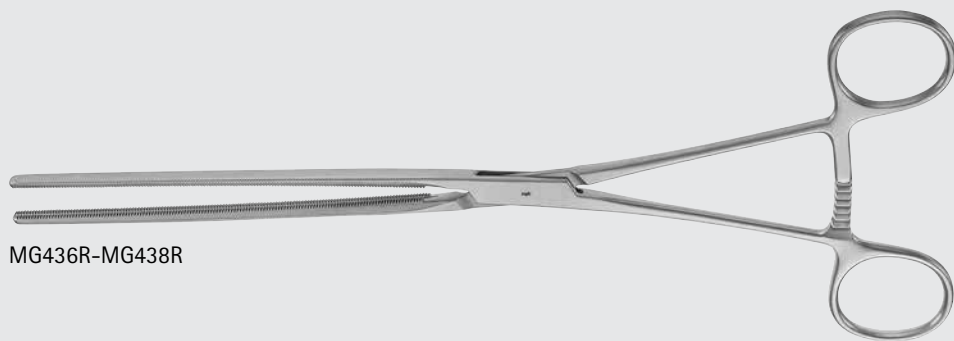

MG436R-MG438R



MG436R



MG437R



MG438R

General Surgery

Atraumatic Intestinal Forceps and Clamps



GLASSMAN Gastroenterostomy Clamp

Catalog Number	Jaw	Jaw Length (mm)	Length (in.)
MG433R	STR	116	11 1/2
MG434R	ANG	115	11 1/2

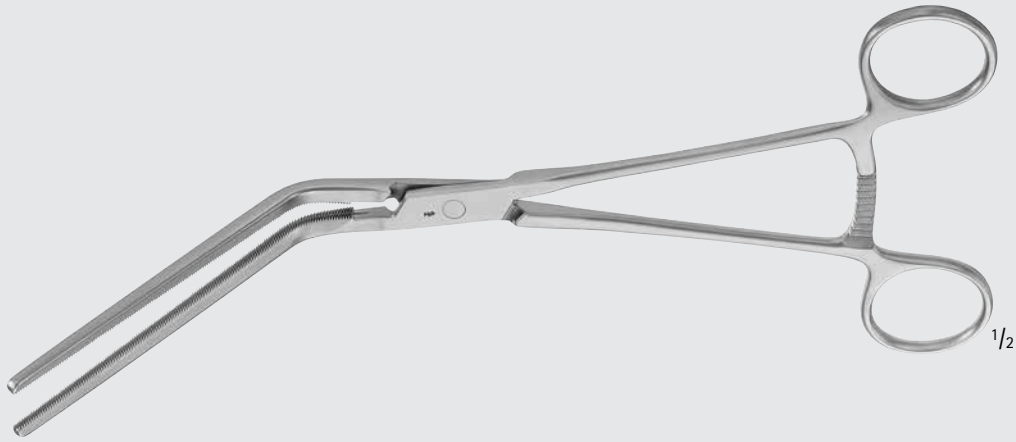

MG433R-MG434R



MG433R

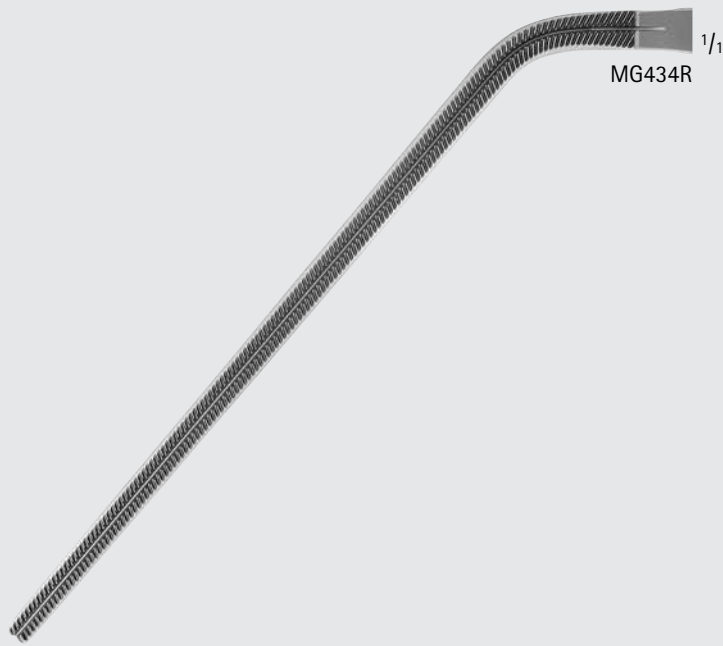

MG434R

GLASSMAN Gastrointestinal Clamp, Non-Crushing

Catalog Number	Jaw	Length (in.)
MB138R	STR	9 1/4
MB139R	ANG	9

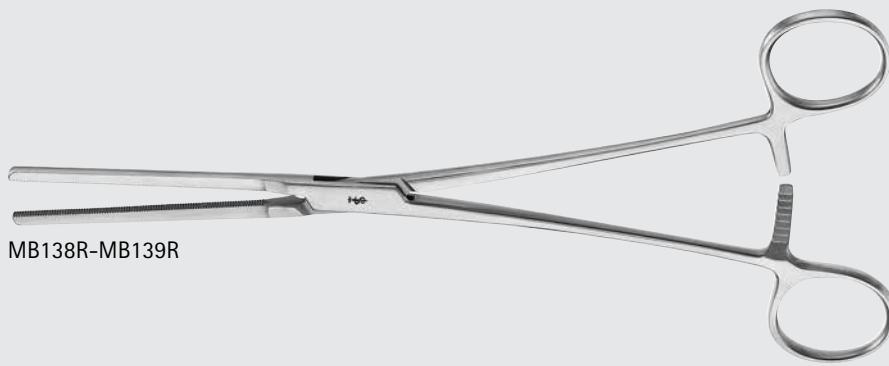

MB138R-MB139R



MB138R

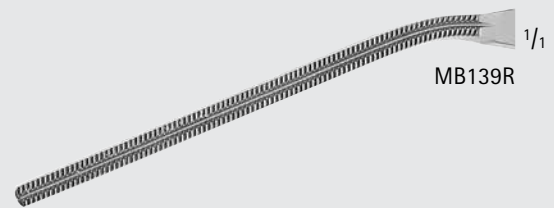

MB139R

LISTER Sponge Forceps

Catalog Number	Jaw	Length (in.)
BF004R	STR	5 1/4
BF006R	STR	6 1/4
BF008R	STR	7 1/4

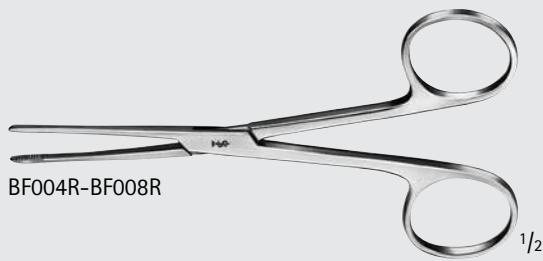

BF004R-BF008R

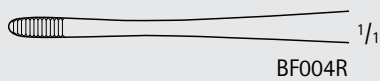

BF004R

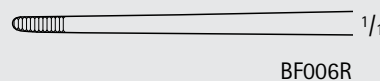

BF006R

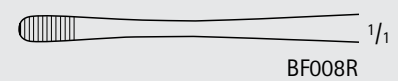

BF008R

GROSS Forceps, W/ Ratchet

Catalog Number	Jaw	Length (in.)
BF046R	STR	7 7/8
BF047R	CVD	7 7/8

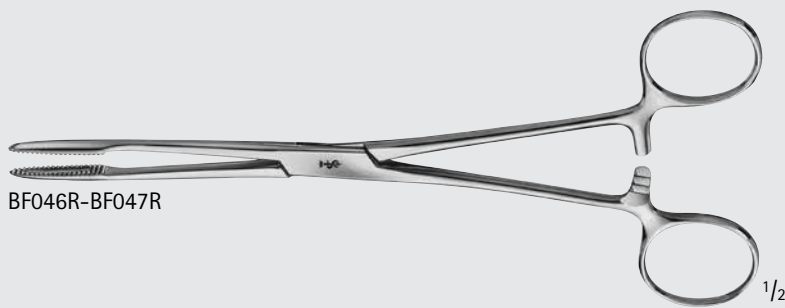

BF046R-BF047R



BF046R

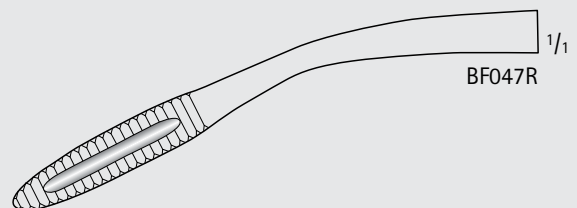

BF047R



INCHES

General Surgery

Dressing and Sponge Forceps

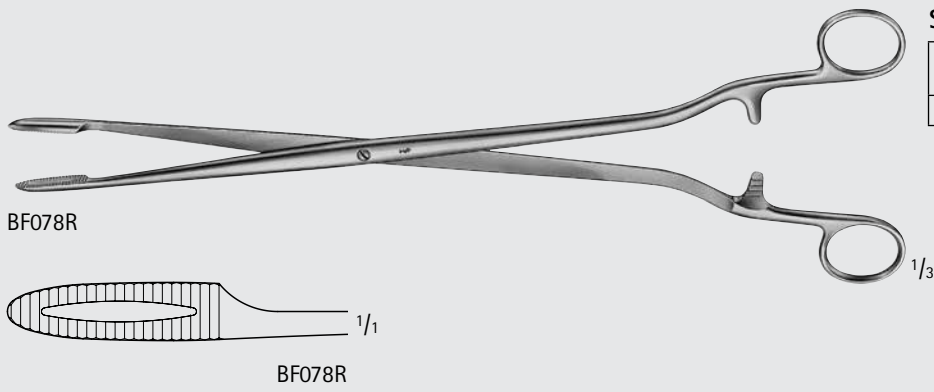

SIMS-MAIER Sponge Forceps

Catalog Number	Jaw	Length (in.)
BF078R	STR	13 3/4

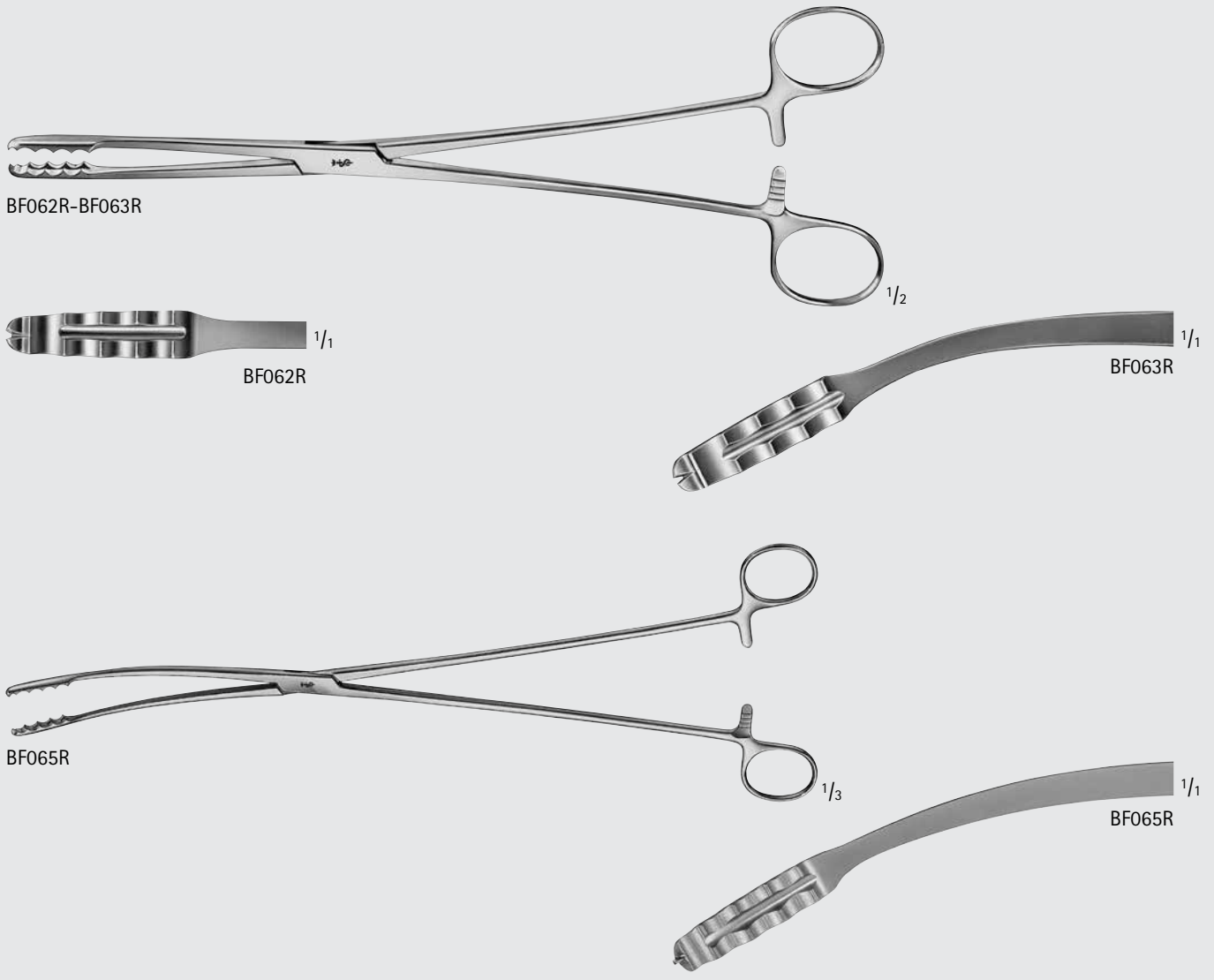

ULRICH-AESCULAP Sponge Forceps

Catalog Number	Jaw	Length (in.)
BF062R	STR	10 1/2
BF063R	CVD	10 1/2
BF065R	CVD	13 3/4

General Surgery

Dressing and Sponge Forceps

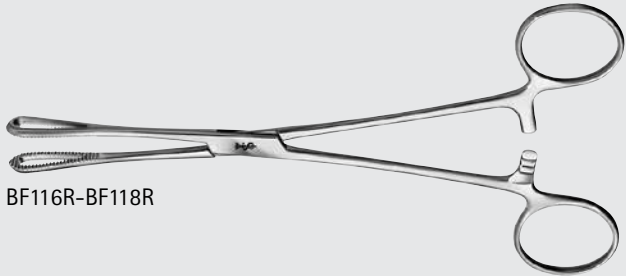

BF116R-BF118R

RAMPLEY Sponge Forceps

Catalog Number	Tip	Jaw	Length (in.)
BF116R	SERR	STR	7
BF118R	SERR	STR	9 3/4



BF116R

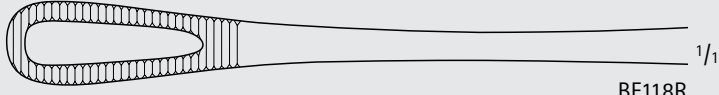

BF118R



General Surgery

Dressing and Sponge Forceps

FOERSTER Sponge Forceps

Catalog Number	Tip	Jaw	Length (in.)
MB098R	SERR	STR	12
MB099R	SERR	STR	14
MB904R	SERR	STR	16

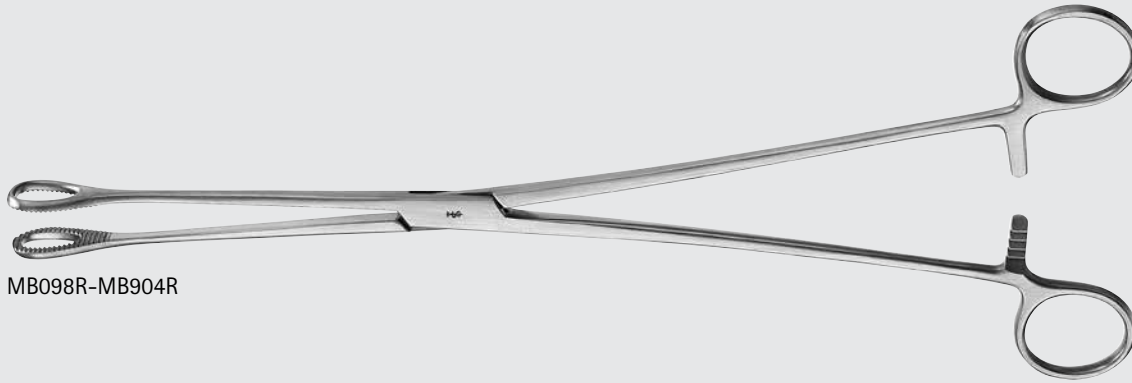

MB098R-MB904R

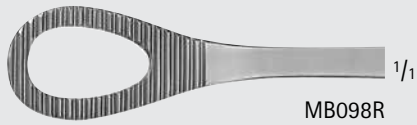

MB098R



MB099R



MB904R



General Surgery

Dressing and Sponge Forceps

GENERAL SURGERY

FOERSTER-BALLENGER Sponge Forceps

Catalog Number	Tip	Jaw	Length (in.)
BF112R	SERR	STR	7
BF120R	SMOOTH	STR	9 5/8
BF122R	SERR	STR	9 5/8
BF113R	SERR	CVD	7
BF121R	SMOOTH	CVD	9 5/8
BF123R	SERR	CVD	9 5/8

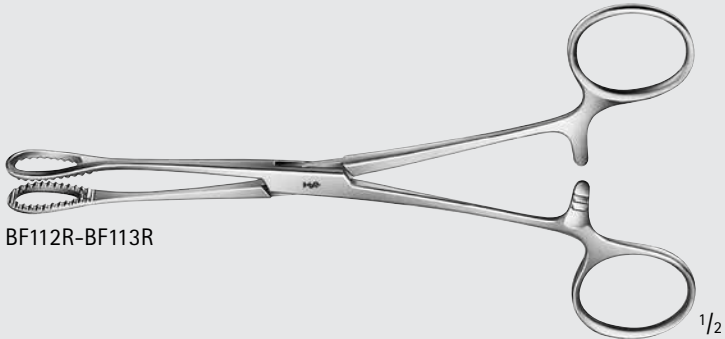

BF112R-BF113R

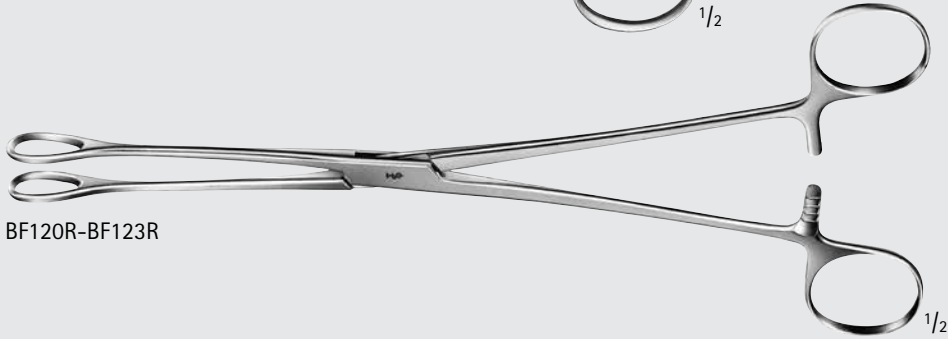

BF120R-BF123R



BF112R



BF120R



BF122R



BF113R



BF121R



BF123R



INCHES

General Surgery

Dressing and Sponge Forceps

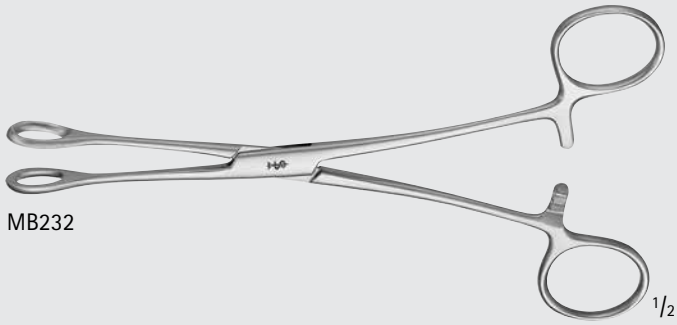

MB232

BALLENGER Sponge Forceps

Catalog Number	Tip	Jaw	Length (in.)
MB232	SMOOTH	STR	7

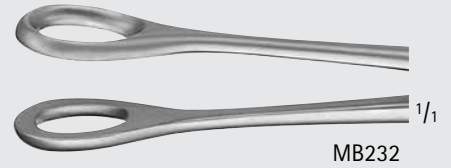

MB232

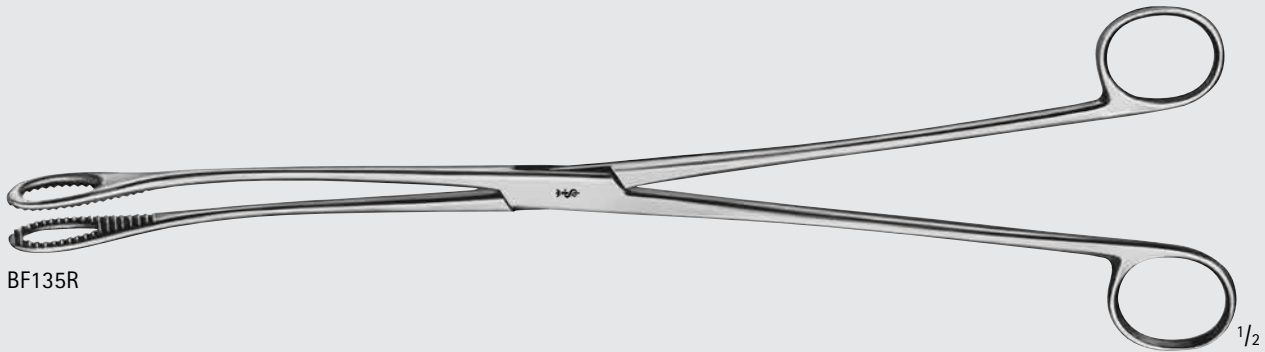

BF135R

KELLY Sponge Forceps

Catalog Number	Tip	Jaw	Handle	Length (in.)
BF135R	SERR	CVD	W/ OUT RATCHET	12 1/2
BF136R	SERR	CVD	W/ RATCHET	12 1/2

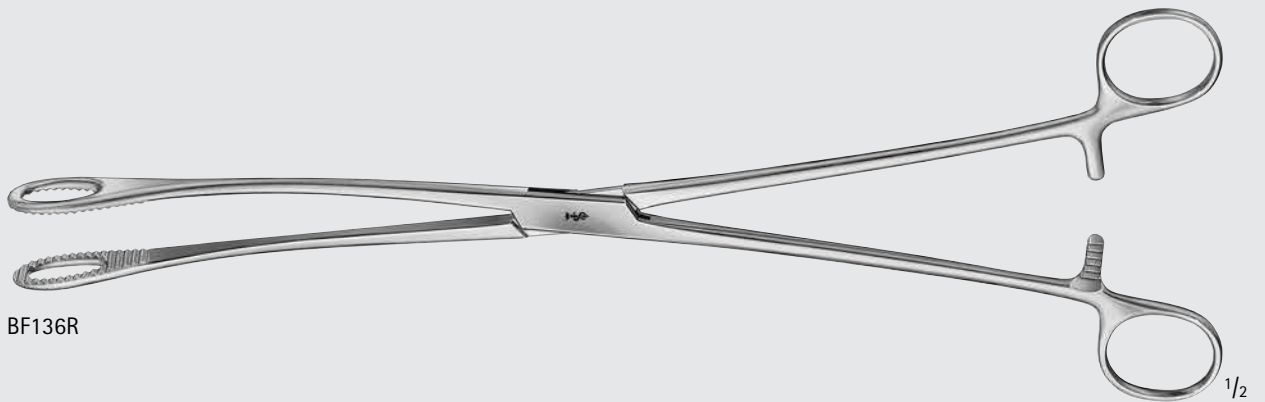

BF136R



BF135R-BF136R

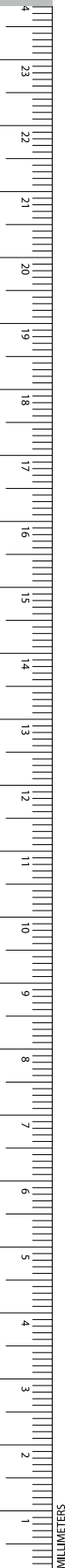

MAGILL Forceps

Catalog Number	Size	Length (in.)
AN379R	INFANT	6
AN380R	PEDIATRIC	7 7/8
AN381R	ADULT	9 3/4



AN379R-AN381R



AN379R

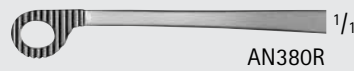

AN380R



AN381R

COLLIN Forceps W/ Ratchet

Catalog Number	Jaw	Length (in.)
BH906R	OVAL	6 1/4
BH908R	TEARDROP	6 1/4

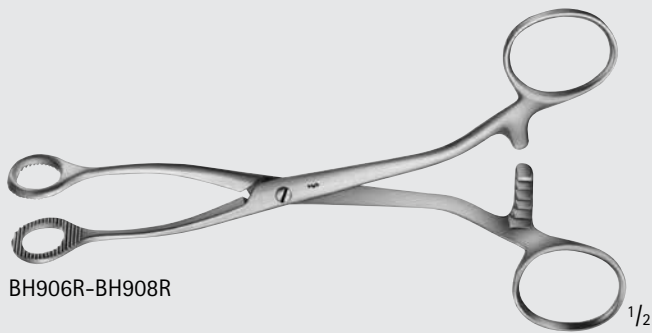

BH906R-BH908R

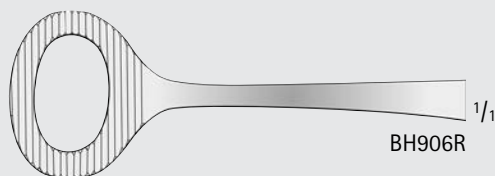

BH906R

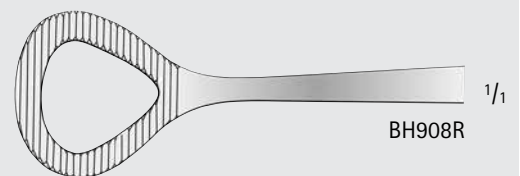

BH908R



General Surgery

Tongue Forceps

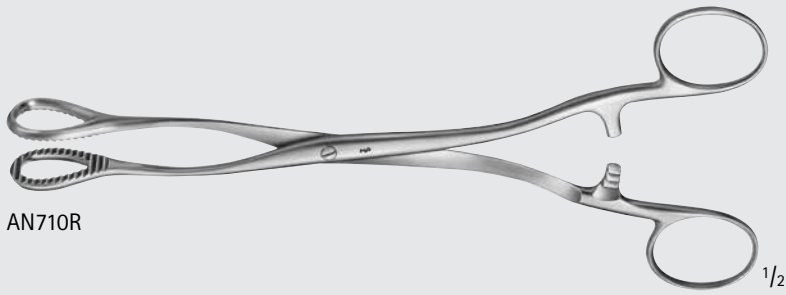

AN710R

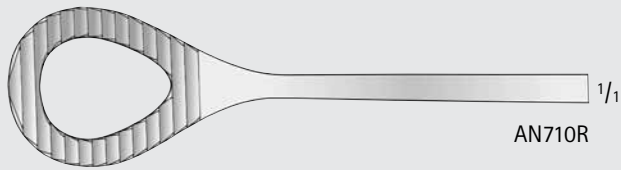

AN710R

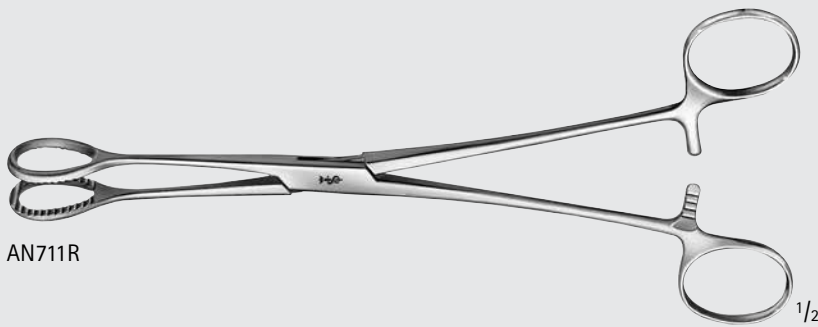

AN711R

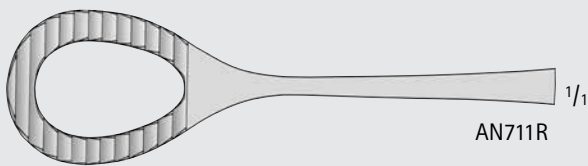

AN711R

HEYWOOD-SMITH Forceps

Catalog Number	Tip	Length (in.)
AN710R	SERR	7 7/8
AN711R	SERR	8 1/4

YEOMAN Rectal Biopsy Forceps

Catalog Number	Tip Size (mm)	Shaft Length (in.)
EA903R	4	16 1/2

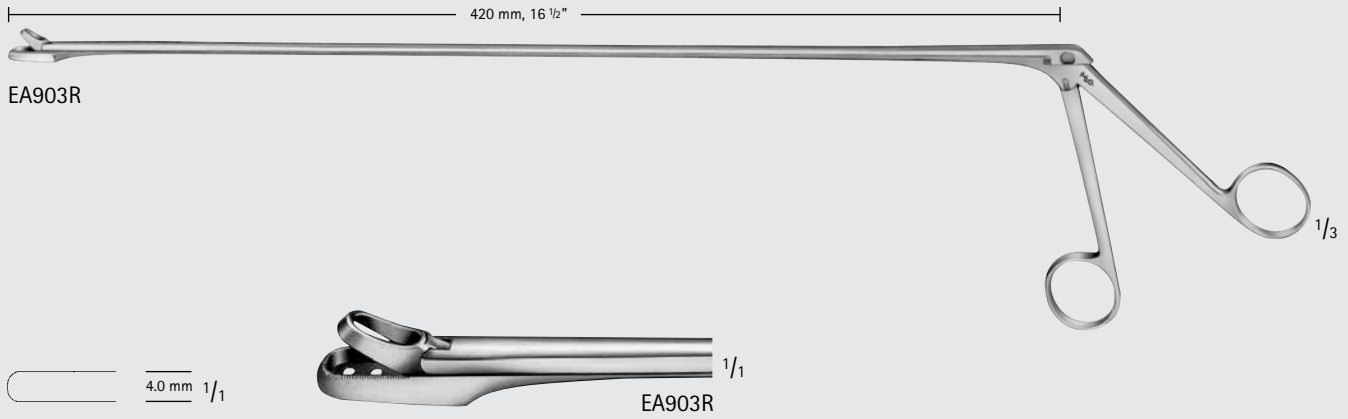

General Surgery

Biopsy Forceps



AESCULAP Rectal Swab Holder

Catalog Number	Shaft Length (in.)
EA943R	15 3/4

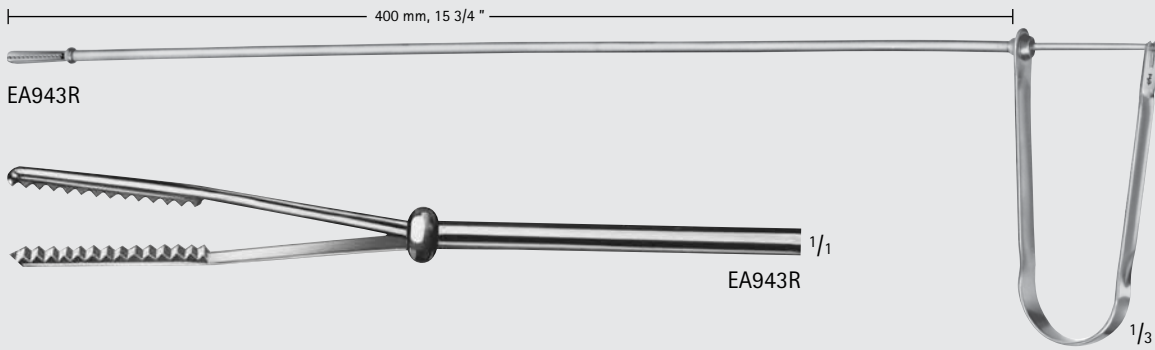

MB200R



MG098R

PRICE Muscle Biopsy Clamp

Catalog Number	Jaw	Jaw Size (mm)	Length (in.)
MB200R	DOUBLE-PRONG	8	4
MG098R	DOUBLE-PRONG	15	4 3/8

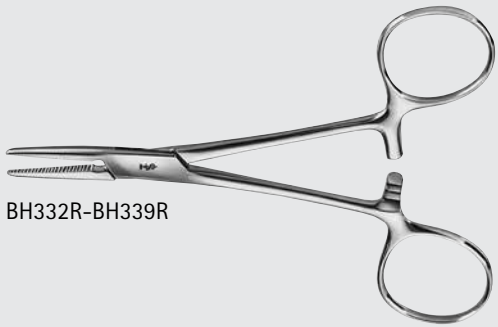

BH332R-BH339R

SPENCER-WELLS Forceps

Catalog Number	Jaw	Length (in.)
BH332R	STR	5 1/8
BH334R	STR	6
BH336R	STR	6 7/8
BH338R	STR	7 7/8
BH333R	CVD	5 1/8
BH335R	CVD	6
BH337R	CVD	6 7/8
BH339R	CVD	7 7/8



BH332R



BH333R



BH334R

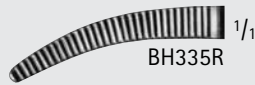

BH335R



BH336R



BH337R



BH338R



BH339R

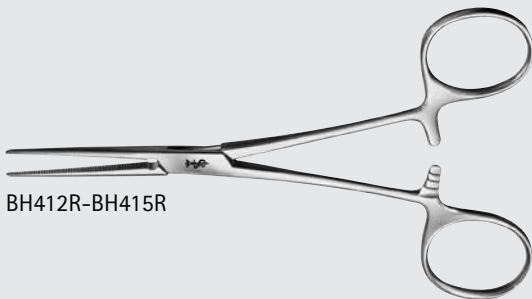

BH412R-BH415R

PEAN Forceps, Delicate

Catalog Number	Jaw	Length (in.)
BH412R	STR	5 1/8
BH414R	STR	5 1/2
BH413R	CVD	5 1/8
BH415R	CVD	5 1/2



BH412R



BH413R



BH414R



BH415R



INCHES

General Surgery

Hemostatic Forceps and Clamps

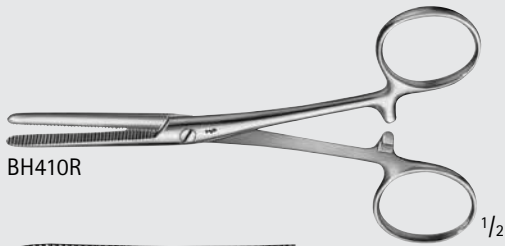

BH410R

1/2



1/1

BH410R

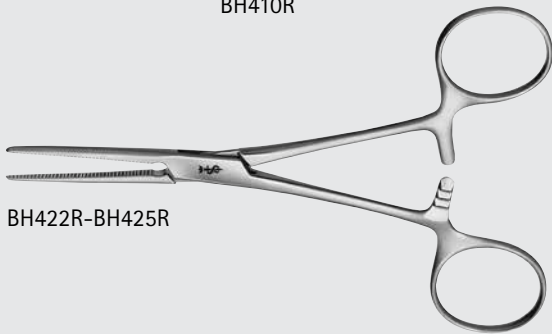

BH422R-BH425R



1/1

BH422R



1/1

BH424R



1/1

BH425R

PEAN Forceps

Catalog Number	Jaw	Length (in.)
BH410R	STR	5
BH422R	STR	5 1/8
BH424R	STR	5 1/2
BH425R	CVD	5 1/2

PEAN Artery Forceps

Catalog Number	Jaw	Length (in.)
MB180R	CVD	12
MB181R	CVD	14

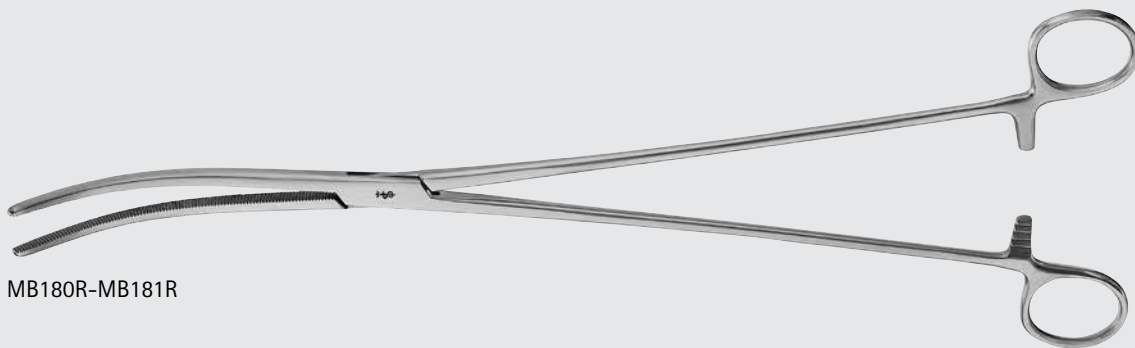

MB180R-MB181R

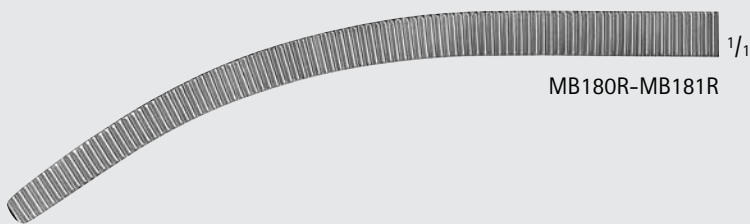

1/1

MB180R-MB181R

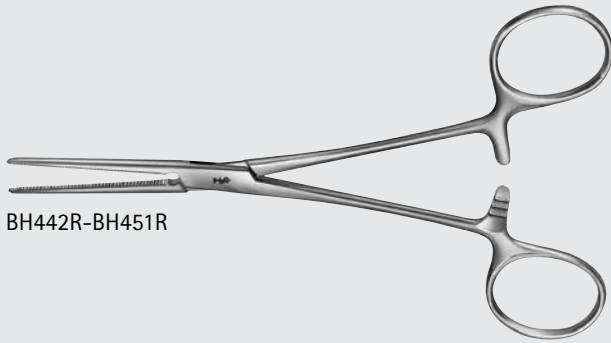

BH442R-BH451R

ROCHESTER-PEAN Forceps

Catalog Number	Jaw	Length (in.)
BH442R	STR	6 1/4
BH444R	STR	7 1/4
BH446R	STR	7 7/8
BH448R	STR	8 7/8
BH450R	STR	9 1/2
BH443R	CVD	6 1/4
BH445R	CVD	7 1/4
BH447R	CVD	7 7/8
BH449R	CVD	8 7/8
BH451R	CVD	9 1/2



BH442R



BH444R



BH446R



BH448R



BH450R



BH443R



BH445R



BH447R



BH449R

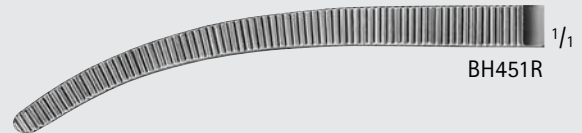

BH451R



INCHES

General Surgery

Hemostatic Forceps and Clamps

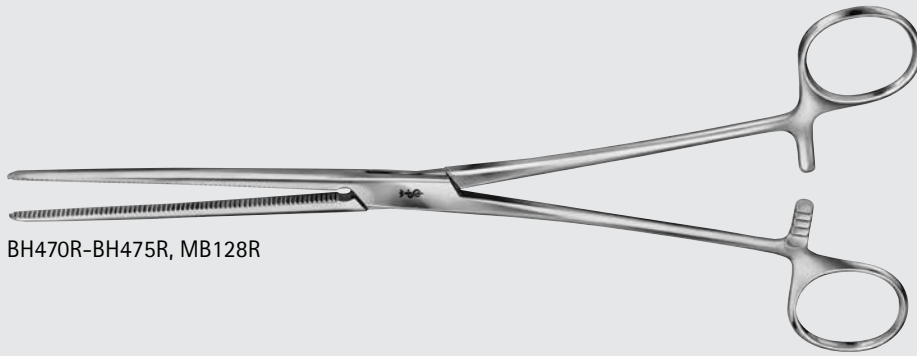

BH470R-BH475R, MB128R

PEAN Forceps, Long

Catalog Number	Jaw	Length (in.)
BH470R	STR	9 1/2
BH472R	STR	10 1/4
BH474R	STR	11
MB128R	STR	12
BH471R	CVD	9 1/2
BH473R	CVD	10 1/4
BH475R	CVD	11



BH470R



BH472R



BH474R



MB128R

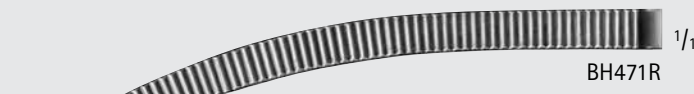

BH471R



BH473R

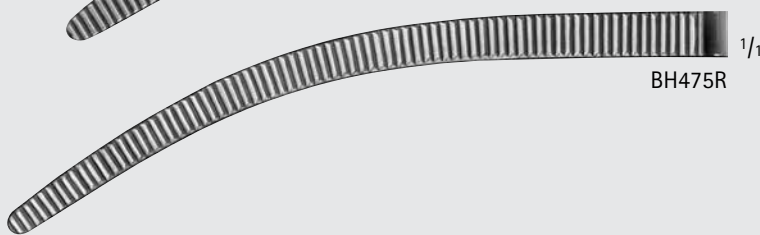

BH475R

KOCHER Forceps, Delicate

Catalog Number	Jaw	Teeth	Length (in.)
BH614R	STR	1 x 2	5 1/2
BH615R	CVD	1 x 2	5 1/2



BH614R-BH615R

1/2



BH614R

1/1



BH615R

1/1

KOCHER Forceps

Catalog Number	Jaw	Teeth	Length (in.)
BH630R	STR	1 x 2	6
BH631R	CVD	1 x 2	6

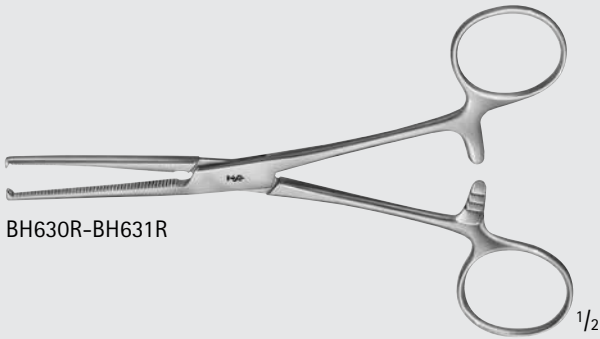

BH630R-BH631R

1/2



BH630R

1/1

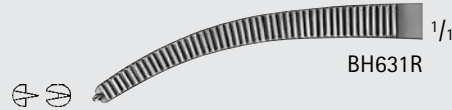

BH631R

1/1



General Surgery

Hemostatic Forceps and Clamps

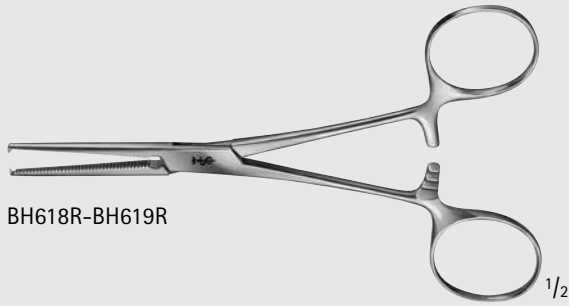

BH618R-BH619R

1/2



BH618R



BH619R

ROCHESTER-OCHSNER Forceps

Catalog Number	Jaw	Teeth	Length (in.)
BH618R	STR	1 x 2	5 1/2
BH619R	CVD	1 x 2	5 1/2

ROCHESTER-OCHSNER Artery Forceps

Catalog Number	Jaw	Teeth	Length (in.)
MB172R	STR	1 x 2	14

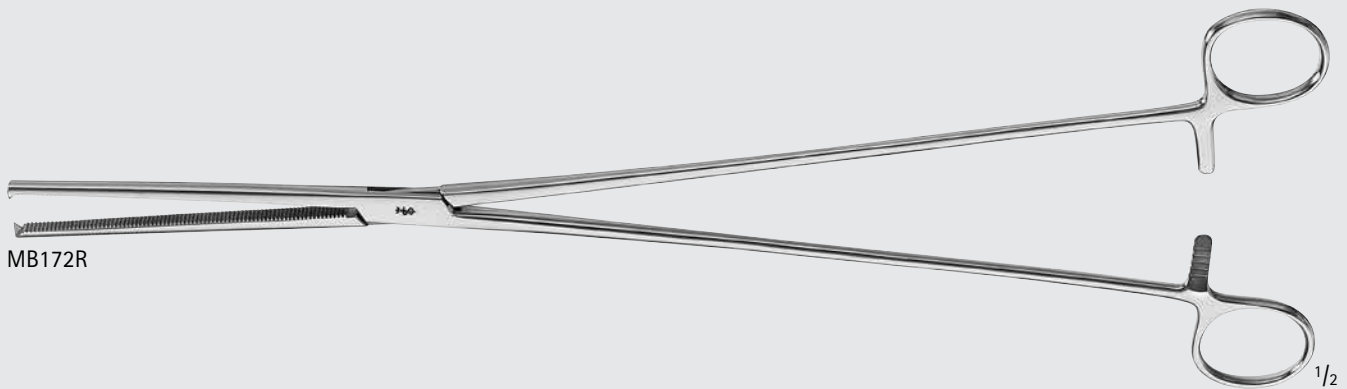

MB172R

1/2



MB172R

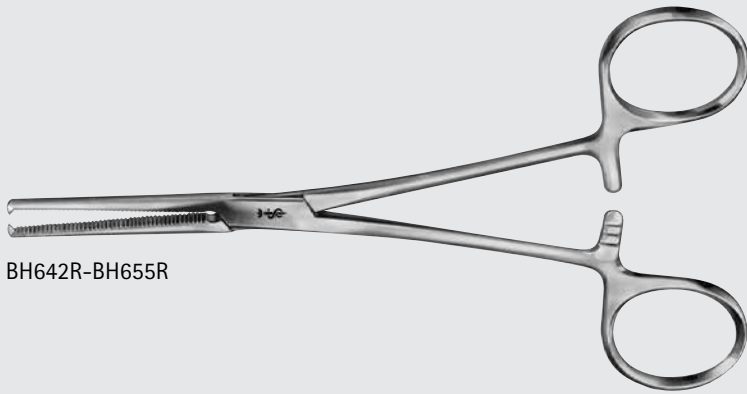

BH642R-BH655R

KOCHER-OCHSNER Forceps

Catalog Number	Jaw	Teeth	Length (in.)
BH642R	STR	1 x 2	6 1/4
BH644R	STR	1 x 2	7 1/4
BH646R	STR	1 x 2	7 7/8
BH648R	STR	1 x 2	8 7/8
BH650R	STR	1 x 2	9 1/2
BH652R	STR	1 x 2	10 1/4
BH654R	STR	1 x 2	11
BH643R	CVD	1 x 2	6 1/4
BH645R	CVD	1 x 2	7 1/4
BH647R	CVD	1 x 2	7 7/8
BH649R	CVD	1 x 2	8 7/8
BH651R	CVD	1 x 2	9 1/2
BH653R	CVD	1 x 2	10 1/4
BH655R	CVD	1 x 2	11



BH642R



BH644R



BH646R



BH648R



BH650R



BH652R



BH654R



BH643R



BH645R



BH647R

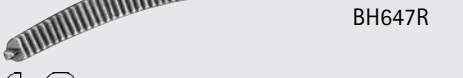

BH649R



BH649R



BH651R



BH653R



BH655R



BH655R



INCHES

General Surgery

Hemostatic Forceps and Clamps



ROCHESTER-OCHSNER Forceps

Catalog Number	Jaw	Teeth	Length (in.)
MB807R	STR	1 x 2	14
MB909R	STR	1 x 2	16
MB908R	CVD	1 x 2	13 3/4

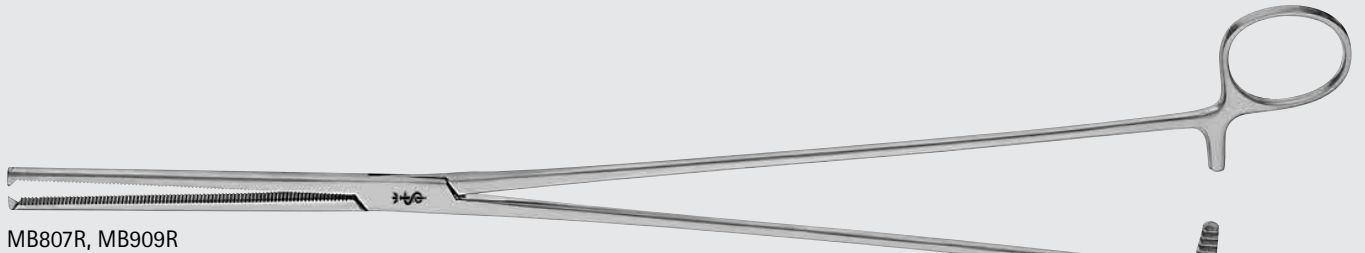

MB807R, MB909R



MB807R

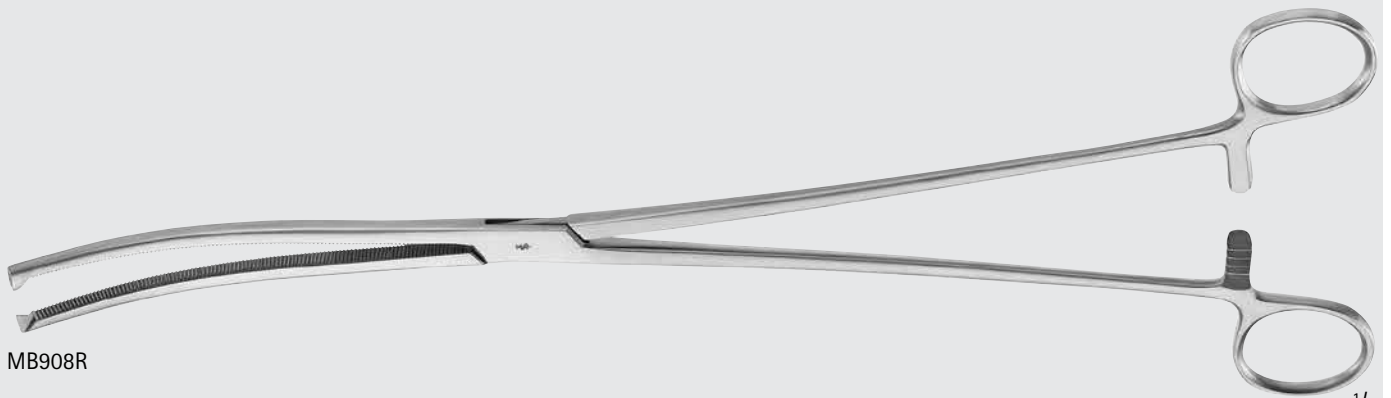

MB908R



MB908R

ROCHESTER-CARMALT Forceps

Catalog Number	Jaw	Length (in.)
BH800R	STR	6 1/4
BH804R	STR	7 7/8
MG196R	STR	9
MG431R	STR	10 1/4
BH801R	CVD	6 1/4
BH805R	CVD	7 7/8
MG197R	CVD	9
MG432R	CVD	10 1/4

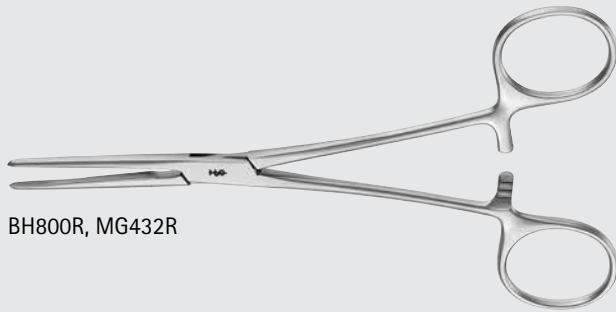

BH800R, MG432R



BH800R



BH804R



MG196R



MG431R



BH801R



BH805R



MG197R



MG432R

STOREY Forceps

Catalog Number	Tip	Length (in.)
MG353R	STRONG-CVD	8 3/4
MG354R	RIGHT-ANG	8 3/4

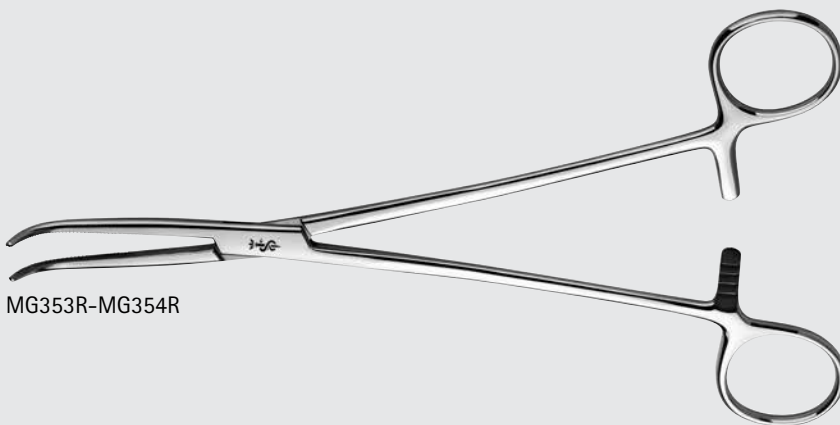

MG353R-MG354R

1/2



MG353R



MG354R



INCHES

General Surgery

Hemostatic Forceps and Clamps



MG426R $\frac{1}{2}$

MG426R $\frac{1}{1}$

JONES Hemostatic Forceps

Catalog Number	Jaw	Length (in.)
MG426R	STR	5

BH831R-BH833R

BH831R $\frac{1}{1}$

BH833R $\frac{1}{1}$

MOYNIHAN Forceps

Catalog Number	Jaw	Length (in.)
BH831R	CVD	9
BH833R	CVD	9 1/2

BH951R-BH952R $\frac{1}{2}$

BH951R $\frac{1}{1}$

BH952R $\frac{1}{1}$

NEGUS Tonsil Forceps

Catalog Number	Jaw	Length (in.)
BH951R	HEAVY-CVD	7 1/2
BH952R	U-CVD	7 1/2

CARMALT Artery Forceps, Longitudinal Serrations

Catalog Number	Jaw	Length (in.)
MB182R	SLIGHT-CVD	12

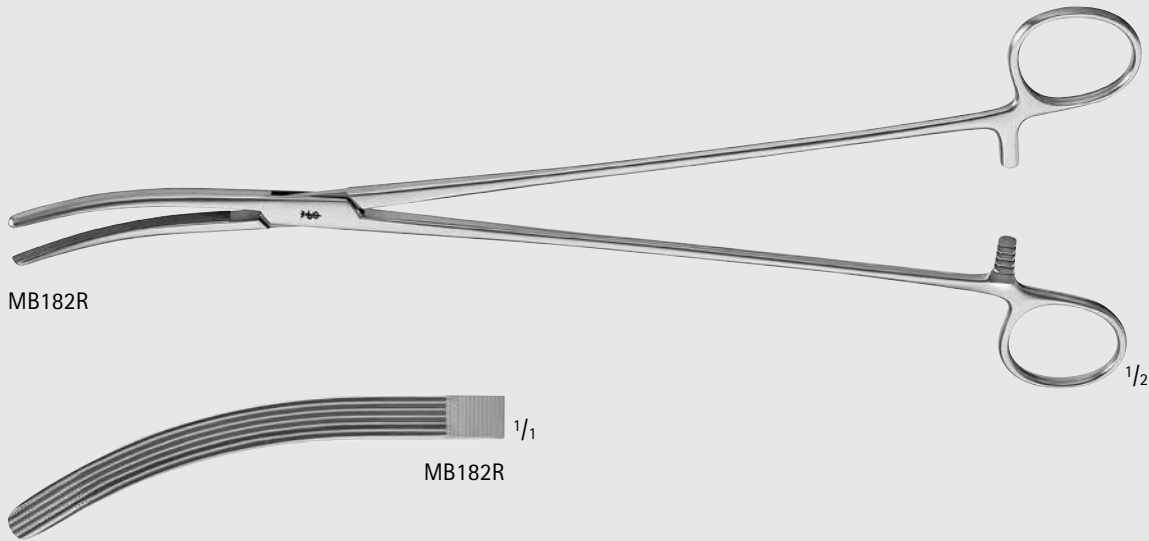

SCHNIDT Tonsil Clamp

Catalog Number	Ring Handle	Jaw	Length (in.)
MA172R	OPEN RING	STR	7 1/2
BH961R	OPEN-RING	SLIGHT-CVD	7 1/4
BH963R	OPEN-RING	CVD	7 1/4
BH957R	CLOSED-RING	SLIGHT-CVD	7 1/4
BH959R	CLOSED-RING	CVD	7 1/4

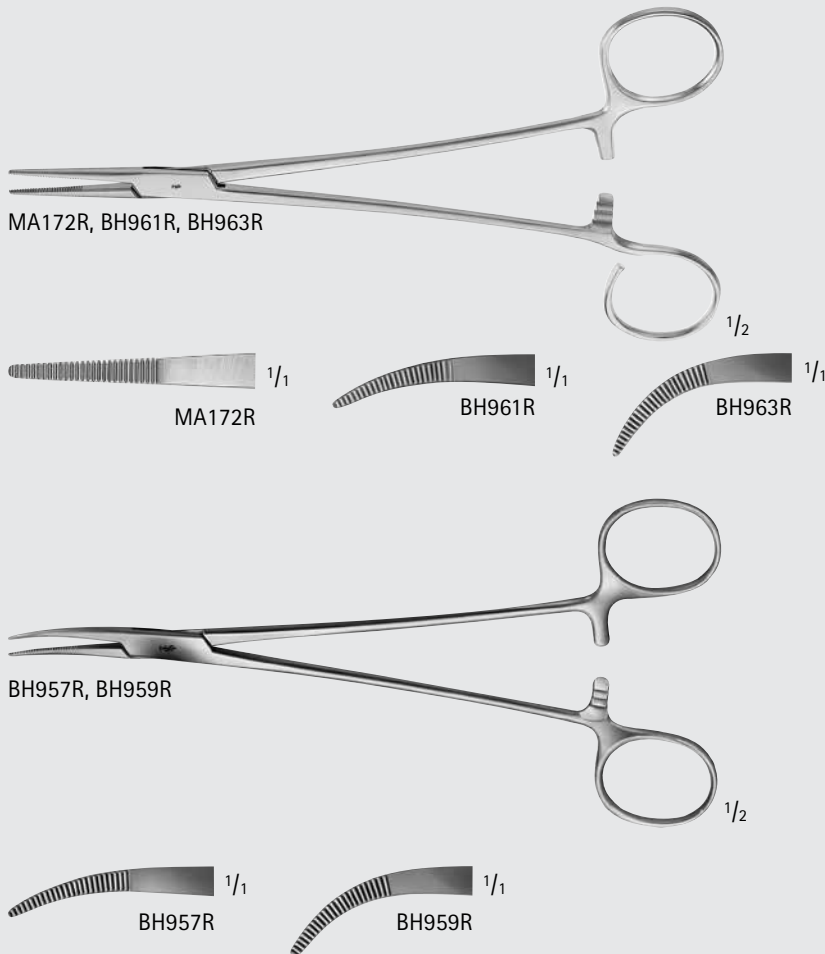

INCHES

General Surgery

Hemostatic Forceps and Clamps



MD450

MD450 $\frac{1}{1}$

$\frac{1}{2}$

OCHSNER-DIXON Artery Forceps

Catalog Number	Jaw	Teeth	Length (in.)
MD450	STR	1 x 2	6 1/4

BH104R-BH115R

BH104R $\frac{1}{1}$

BH105R $\frac{1}{1}$

BH114R $\frac{1}{1}$

BH115R $\frac{1}{1}$

$\frac{1}{2}$

Baby HARTMANN Mosquito Artery Forceps

Catalog Number	Jaw	Teeth	Length (in.)
BH104R	STR	-	4
BH114R	STR	1 x 2	4
BH105R	CVD	-	4
BH115R	CVD	1 x 2	4

BH108R-BH119R

BH108R $\frac{1}{1}$

BH109R $\frac{1}{1}$

BH118R $\frac{1}{1}$

BH119R $\frac{1}{1}$

$\frac{1}{2}$

Micro HALSTED Mosquito Forceps, Delicate

Catalog Number	Jaw	Teeth	Length (in.)
BH108R	STR	-	5
BH118R	STR	1 x 2	5
BH109R	CVD	-	5
BH119R	CVD	1 x 2	5

HALSTED Mosquito Forceps, Delicate

Catalog Number	Jaw	Teeth	Length (in.)
BH110R	STR	-	5
BH120R	STR	1 x 2	5
BH210R	STR	-	7 7/8
BH214R	STR	1 x 2	7 7/8
BH111R	CVD	-	5
BH121R	CVD	1 x 2	5
BH211R	CVD	-	7 7/8
BH215R	CVD	1 x 2	7 7/8

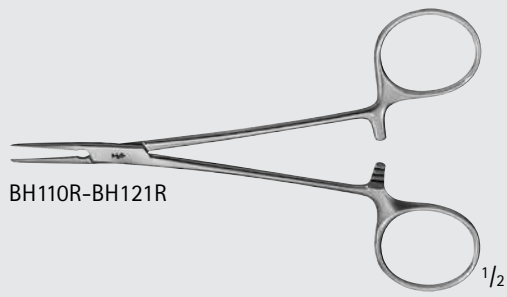

BH110R-BH121R



BH110R



BH111R



BH120R



BH121R

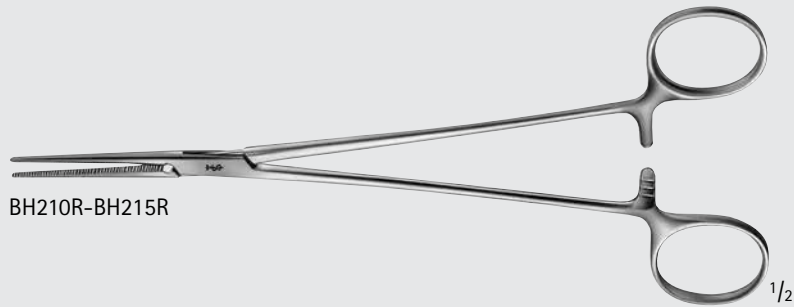

BH210R-BH215R



BH210R



BH211R



BH214R



BH215R

JACOBSON Mosquito Forceps

Catalog Number	Jaw	Length (in.)
BH106R	STR	5 1/8
MB229R	CVD	5

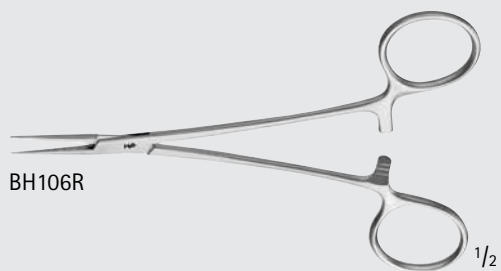

BH106R



BH106R

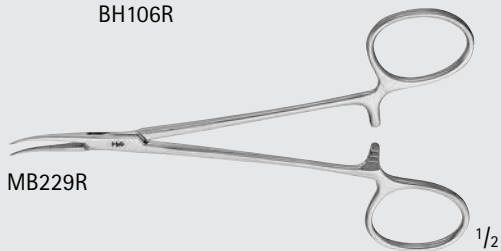

MB229R



MB229R



INCHES

General Surgery

Hemostatic Forceps and Clamps



MG085R $\frac{1}{2}$

MG085R $\frac{1}{1}$

Catalog Number	Jaw	Length (in.)
MG085R	DEL, CVD.	6

BJ002R $\frac{1}{2}$

BJ002R $\frac{1}{1}$

Catalog Number	Tip	Jaw	Length (in.)
BJ002R	SMOOTH	STR	3 3/4

BH187R $\frac{1}{2}$

BH187R $\frac{1}{1}$

BH189R $\frac{1}{2}$

BH189R $\frac{1}{1}$

Catalog Number	Jaw	Length (in.)
BH187R	SLIGHT-CVD	7 1/2
BH189R	HEAVY-CVD	7 1/2

ADSON Hemostatic Forceps

Catalog Number	Jaw	Length (in.)
BH205R	CVD	8 1/2

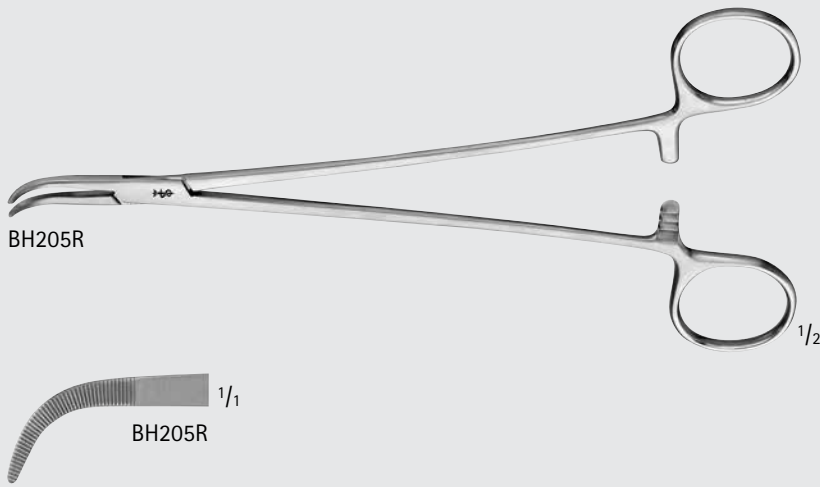

HALSTED Forceps Delicate

Catalog Number	Jaw	Teeth	Length (in.)
BH202R	STR	-	7 1/4
BH212R	STR	1 x 2	7 1/4
BH203R	CVD	-	7 1/4
BH213R	CVD	1 x 2	7 1/4

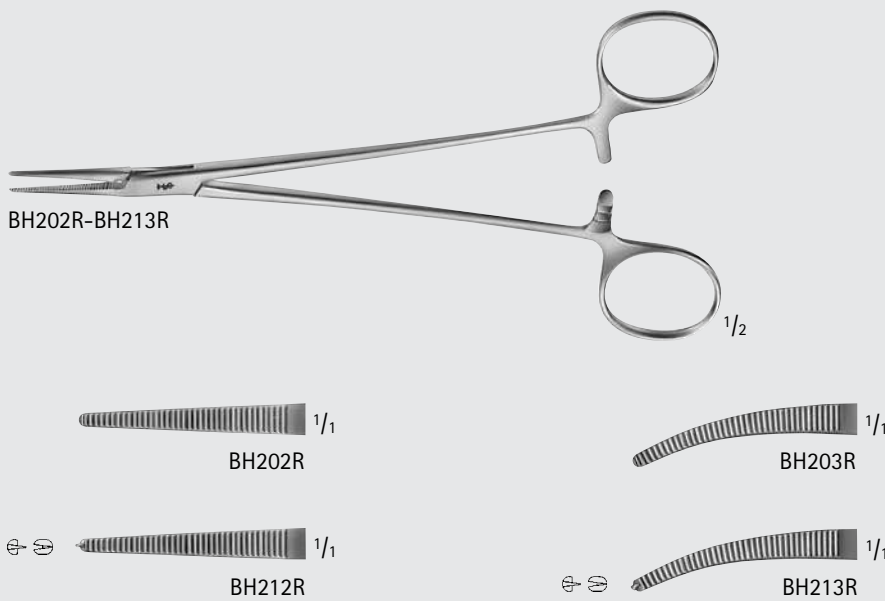

PROVIDENCE Hospital Forceps, Delicate

Catalog Number	Jaw	Length (in.)
BH130R	STR	5 1/2
BH131R	CVD	5 1/2

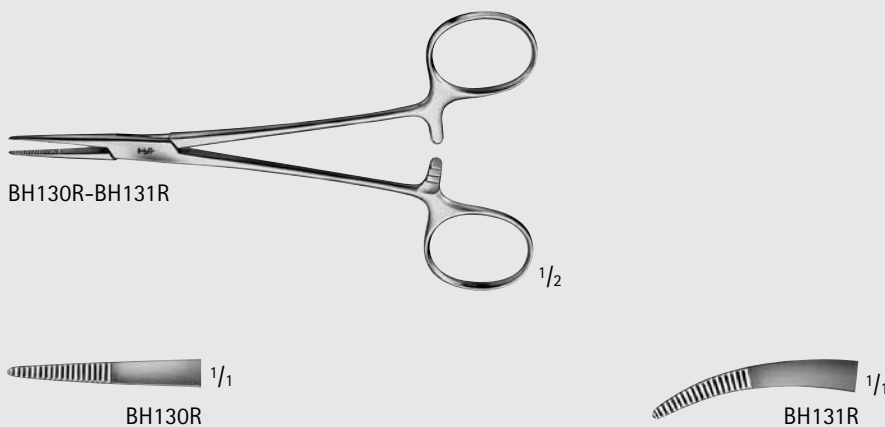

General Surgery

Hemostatic Forceps and Clamps

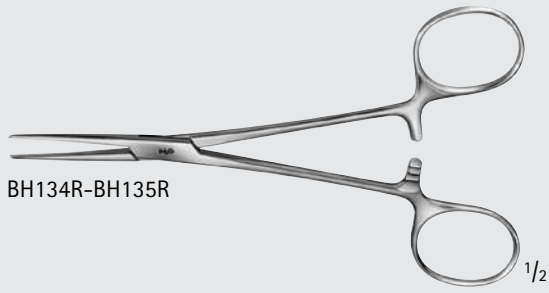

BH134R-BH135R



BH134R



BH135R

KELLY Forceps

Catalog Number	Jaw	Length (in.)
BH134R	STR	5 1/2
BH135R	CVD	5 1/2

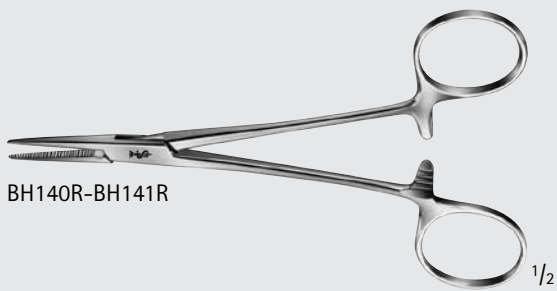

BH140R-BH141R



BH140R



BH141R

Baby CRILE Forceps

Catalog Number	Jaw	Teeth	Length (in.)
BH140R	STR	-	5 1/2
BH150R	STR	1 x 2	5 1/2
BH141R	CVD	-	5 1/2
BH151R	CVD	1 x 2	5 1/2

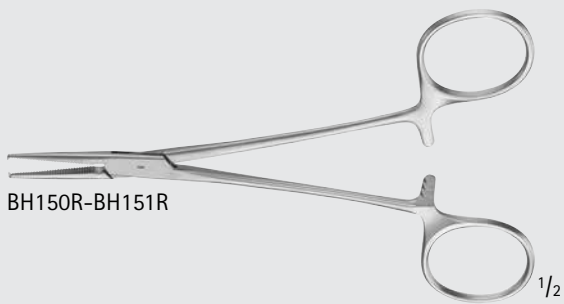

BH150R-BH151R



BH150R

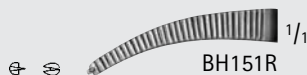

BH151R

CRILE Forceps

Catalog Number	Jaw	Teeth	Length (in.)
BH144R	STR	-	5 1/2
BH154R	STR	1 x 2	5 1/2
BH166R	STR	-	6 1/4
BH176R	STR	1 x 2	6 1/4
BH145R	CVD	-	5 1/2
BH155R	CVD	1 x 2	5 1/2
BH167R	CVD	-	6 1/4
BH177R	CVD	1 x 2	6 1/4



BH144R-BH155R



BH144R



BH145R



BH154R



BH155R

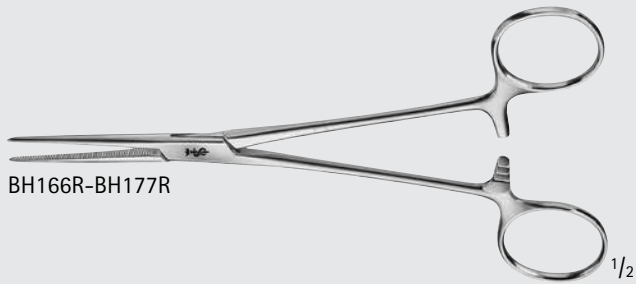

BH166R-BH177R



BH166R

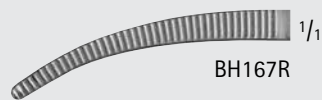

BH167R



BH176R



BH177R



INCHES

General Surgery

Hemostatic Forceps and Clamps

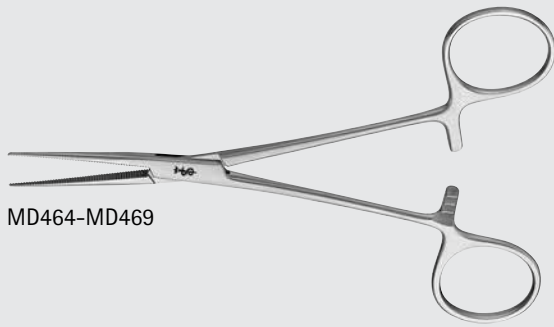

MD464-MD469



MD464



MD466R



MD468



MD465R



MD467R



MD469

COLLER Artery Forceps

Catalog Number	Jaw	Length (in.)
MD464	STR	5 3/4
MD466R	STR	6 1/2
MD468	STR	7
MD465R	CVD	5 3/4
MD467R	CVD	6 1/2
MD469	CVD	7

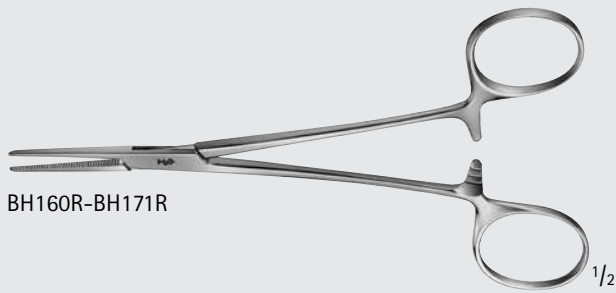

BH160R-BH171R



BH160R



BH170R

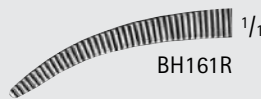

BH161R



BH171R

LERICHE Forceps, Delicate

Catalog Number	Jaw	Teeth	Length (in.)
BH160R	STR	-	6
BH170R	STR	1 x 2	6
BH161R	CVD	-	6
BH171R	CVD	1 x 2	6

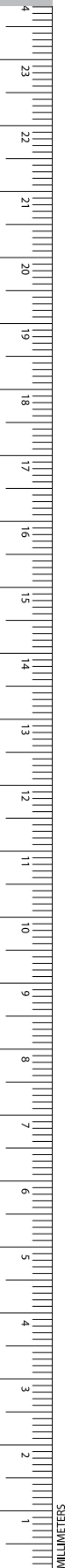



RANKIN Forceps, Delicate

Catalog Number	Jaw	Length (in.)
BH164R	STR	6 1/4
BH165R	CVD	6 1/4

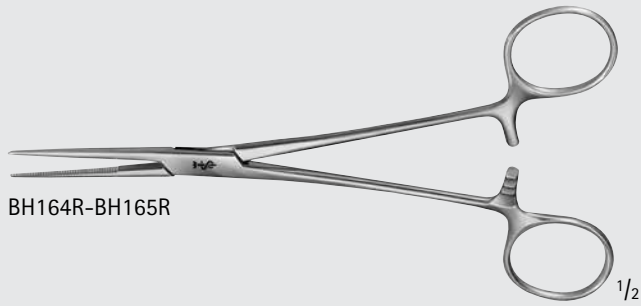

BH164R-BH165R



BH164R



BH165R

BIRKETT Hemostatic Forceps

Catalog Number	Jaw	Length (in.)
BH197R	CVD	7 1/4

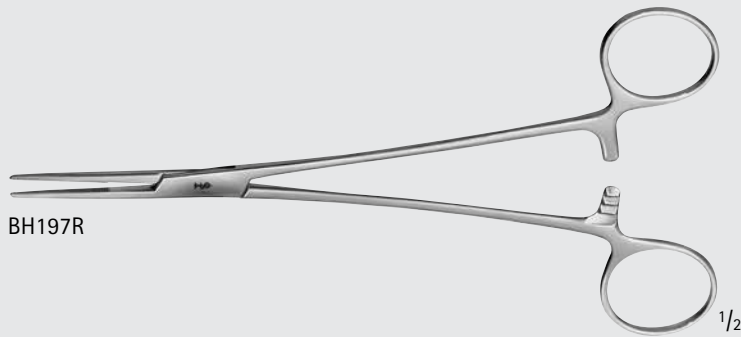

BH197R



BH197R

NISSEN Tonsil Forceps, Delicate

Catalog Number	Jaw	Length (in.)
BH199R	CVD	7 1/4

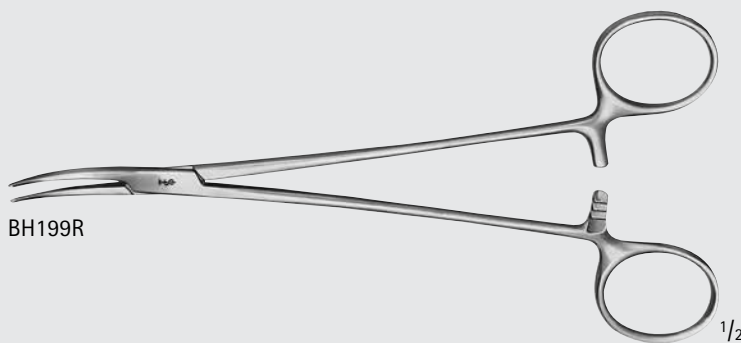

BH199R



BH199R

General Surgery

Hemostatic Forceps and Clamps



BH200R-BH201R

BH200R 1/1

BH201R 1/1

1/2

ADSON Tonsil Forceps, Delicate

Catalog Number	Jaw	Length (in.)
BH200R	STR	7 1/4
BH201R	CVD	7 1/4

BH206R-BH217R

BH206R 1/1

BH207R 1/1

BH216R 1/1

BH217R 1/1

BH209R 1/1

HEISS Forceps, Delicate

Catalog Number	Jaw	Teeth	Length (in.)
BH206R	STR	-	7 7/8
BH216R	STR	1 x 2	7 7/8
BH207R	CVD	-	7 7/8
BH217R	CVD	1 x 2	7 7/8
BH209R	HVY-CVD	-	7 3/4

BENGOLEA Forceps, Delicate

Catalog Number	Jaw	Length (in.)
BH228R	STR	9 5/8
BH229R	CVD	9 5/8

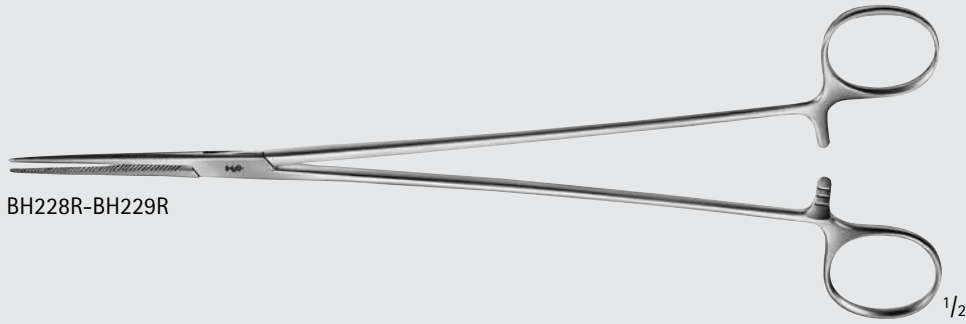

BH228R-BH229R



BH228R



BH229R

BRIDGE Forceps, Delicate

Catalog Number	Jaw	Length (in.)
BH230R	STR	10 3/4
BH231R	CVD	10 3/4

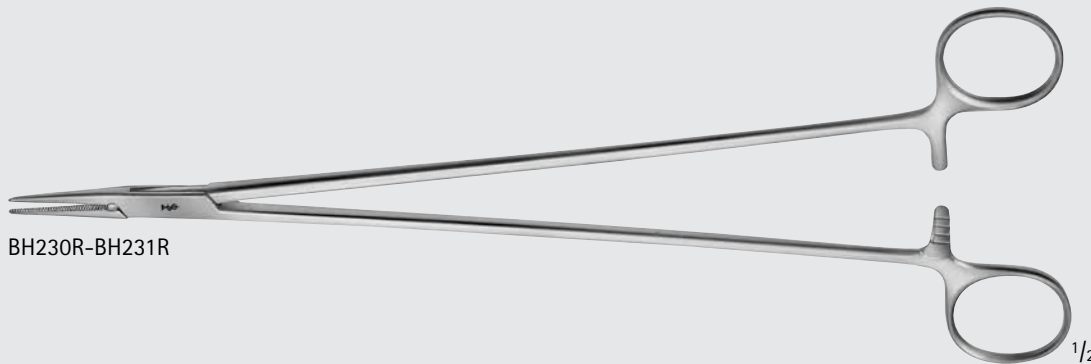

BH230R-BH231R



BH230R



BH231R



General Surgery

Dissecting and Right Angle Forceps

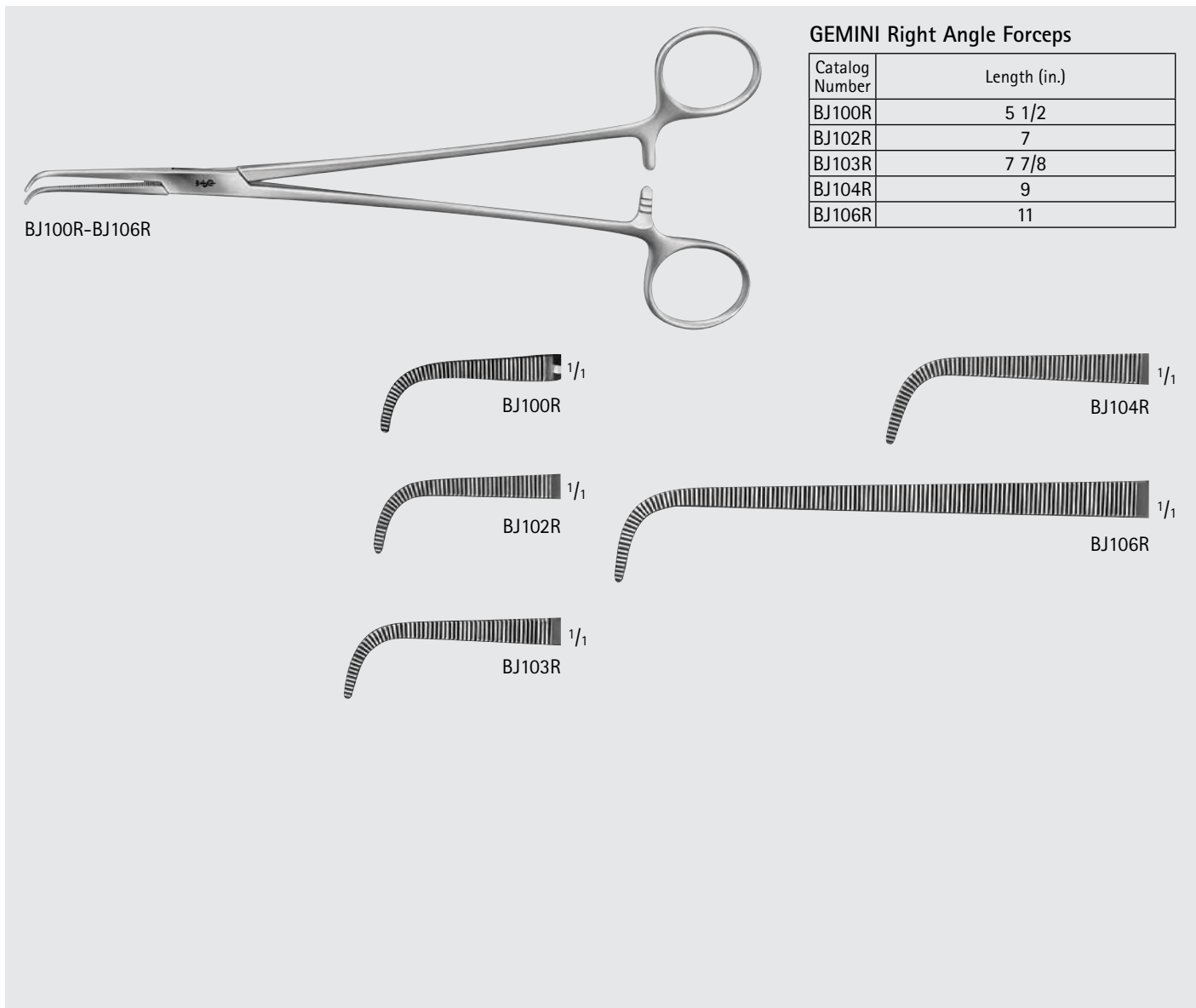

GEMINI Right Angle Forceps

Catalog Number	Length (in.)
BJ100R	5 1/2
BJ102R	7
BJ103R	7 7/8
BJ104R	9
BJ106R	11

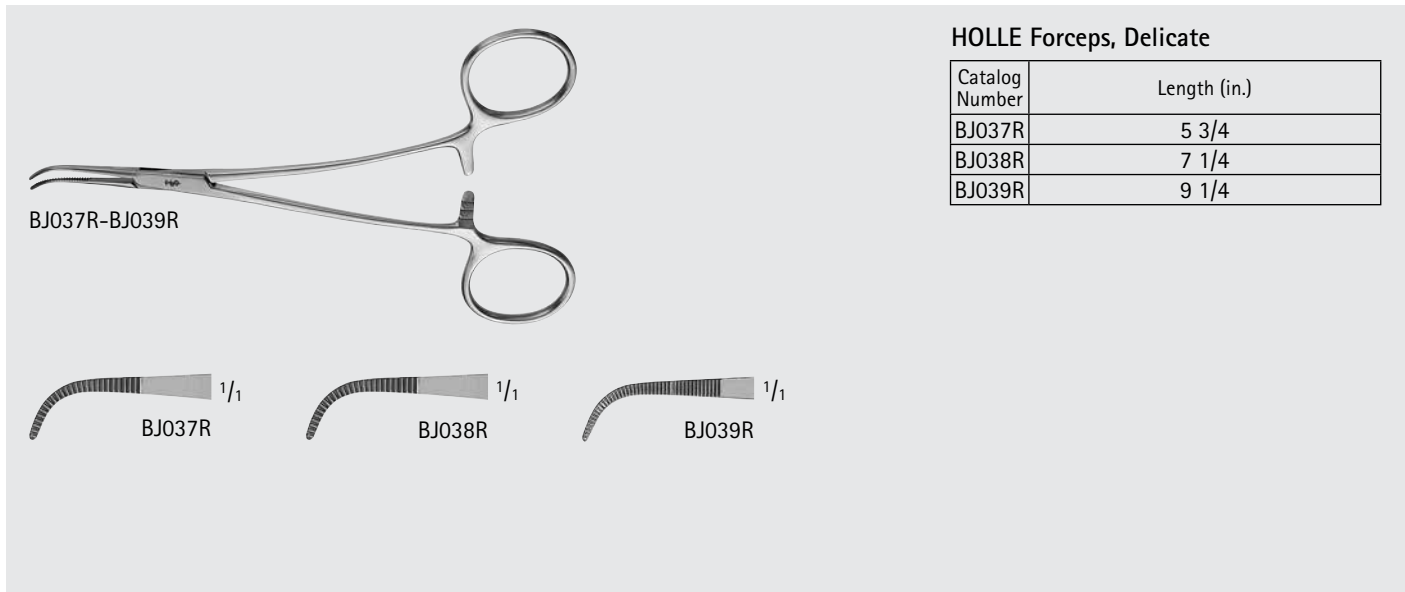

HOLLE Forceps, Delicate

Catalog Number	Length (in.)
BJ037R	5 3/4
BJ038R	7 1/4
BJ039R	9 1/4

General Surgery

Dissecting and Right Angle Forceps

KANTROWITZ Right Angle Forceps

Catalog Number	Length (in.)
MB058R	6 3/8
BJ057R	7 7/8
BJ058R	9 5/8
BJ059R	10 3/4
MB061R	12

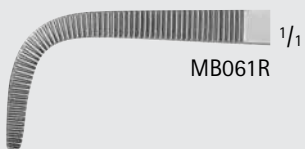
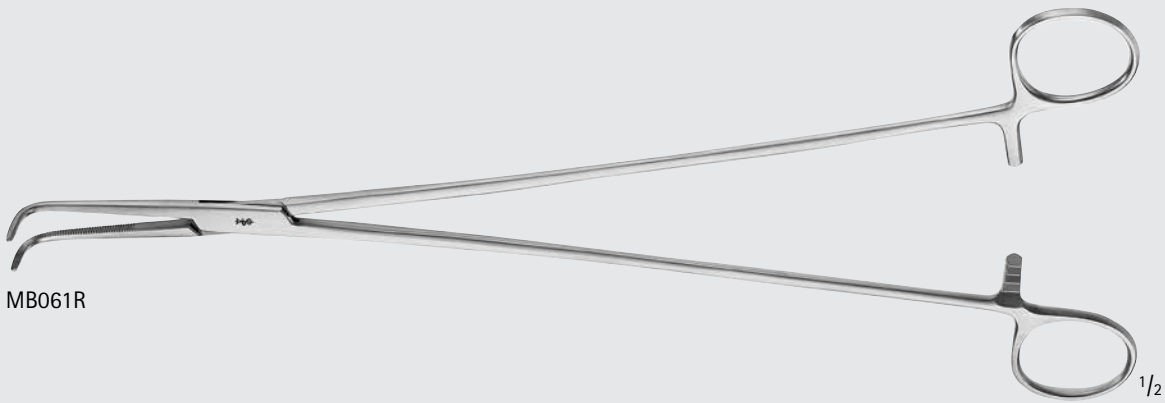
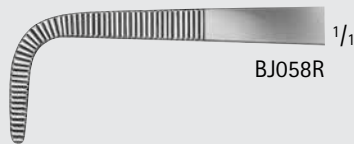
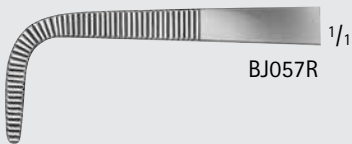
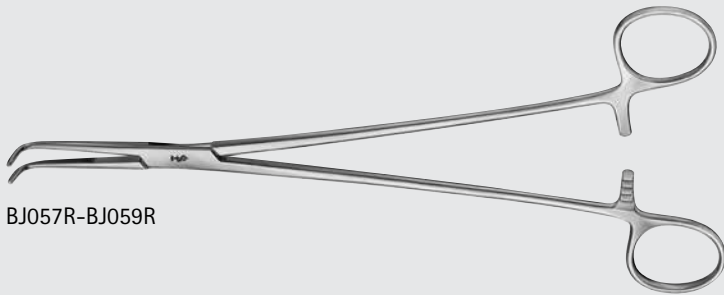
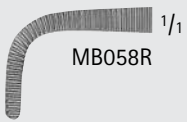
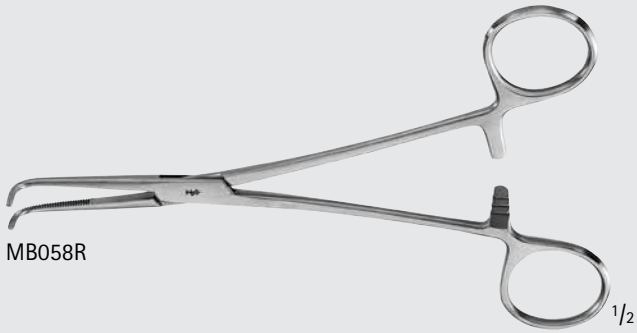

General Surgery

Dissecting and Right Angle Forceps



BJ013R-BJ014R

BJ013R $\frac{1}{1}$

BJ014R $\frac{1}{1}$

Baby ADSON Forceps

Catalog Number	Length (in.)
BJ013R	5 1/2
BJ014R	7

BJ008R

BJ008R $\frac{1}{1}$

Micro ADSON Suture Forceps

Catalog Number	Length (in.)
BJ008R	5 1/2

MD569-MD570R

MD569 $\frac{1}{1}$

MD570R $\frac{1}{1}$

MIXTER (MEEKER) Right Angle Forceps

Catalog Number	Length (in.)
MD569	5 1/2
MD570R	7

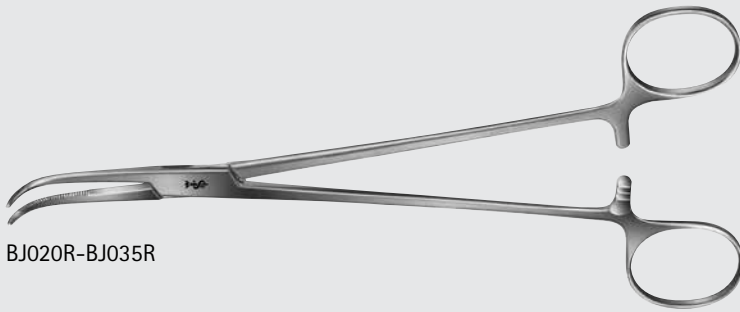

BJ020R-BJ035R

OVERHOLT-GEISSENDOERFER Forceps

Catalog Number	Jaw Curve (#)	Length (in.)
BJ020R	0	7 3/4
BJ021R	1	8
BJ022R	2	8 3/4
BJ023R	3	8 7/8
BJ024R	4	8 3/4
BJ025R	5	9
BJ026R	6	8 7/8
BJ031R	1	10 1/4
BJ032R	2	10 5/8
BJ033R	3	10 3/4
BJ034R	4	10 5/8
BJ035R	5	11

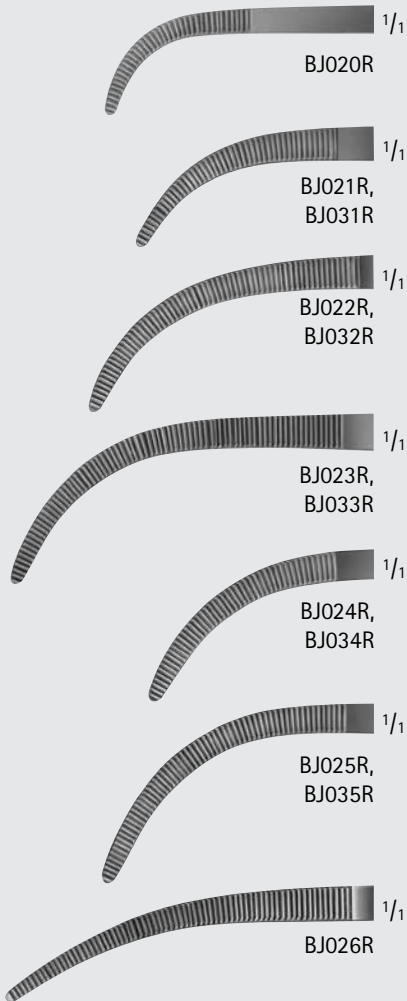

General Surgery

Dissecting and Right Angle Forceps

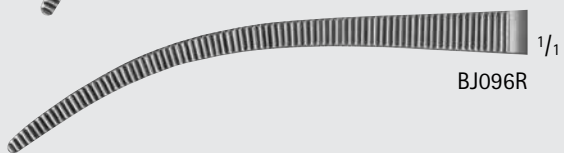
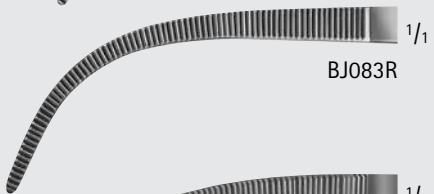
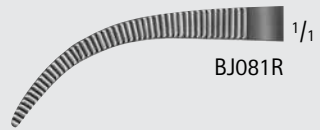
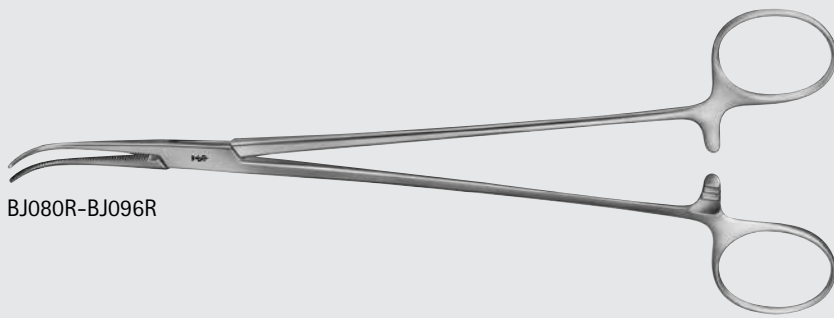

OVERHOLT Forceps

Catalog Number	Jaw Curve (#)	Length (in.)
BJ080R	0	8 1/2
BJ081R	1	8 1/4
BJ082R	2	8 3/4
BJ083R	3	8 7/8
BJ086R	6	8 7/8
BJ090R	0	11 5/8
BJ091R	1	11 5/8
BJ096R	6	11 3/4



General Surgery

Dissecting and Right Angle Forceps

MEEKER Forceps

Catalog Number	Length (in.)
MB459R	11

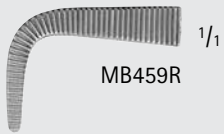
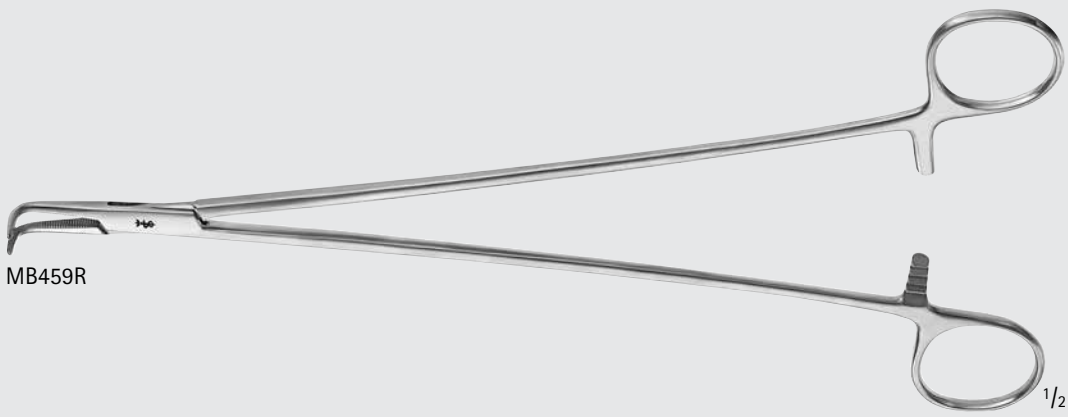

INCHES

General Surgery

Dissecting and Right Angle Forceps

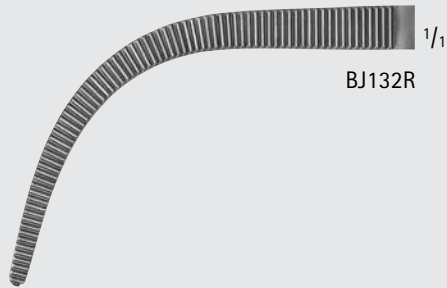
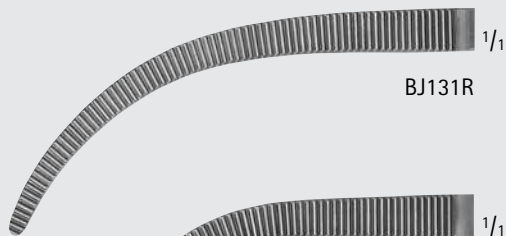
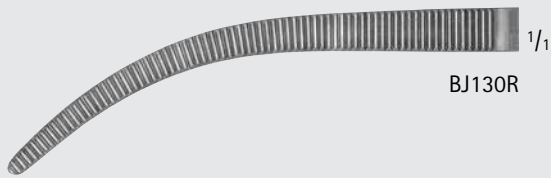
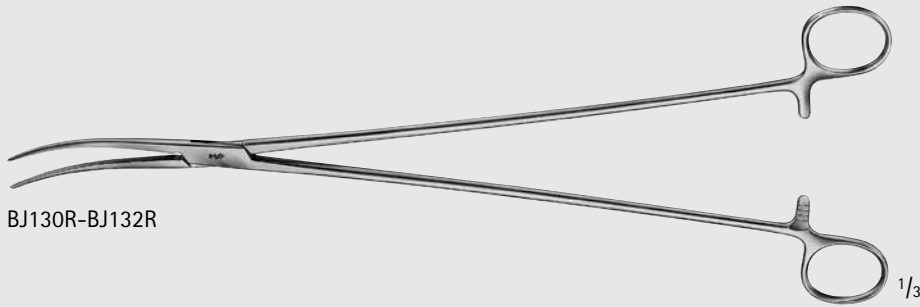
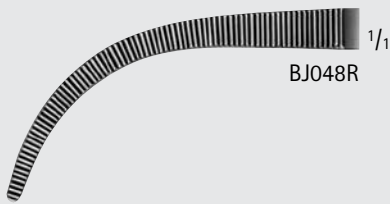
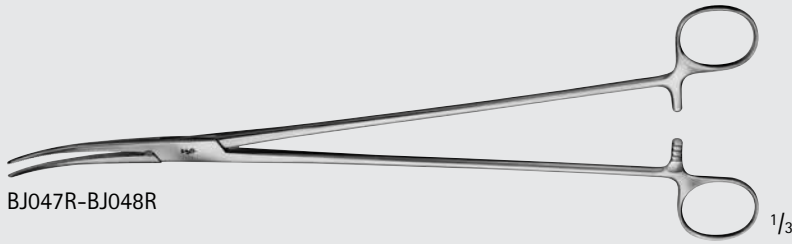

ZENKER Ligature Forceps

Catalog Number	Jaw	Length (in.)
BJO47R	SLIGHT-CVD	11 3/4
BJO48R	HEAVY-CVD	11 1/2
BJ130R	SLIGHT-CVD	13 3/4
BJ131R	CVD	13 3/4
BJ132R	HEAVY-CVD	13 3/4

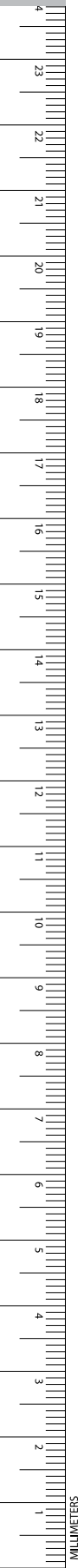

General Surgery

Dissecting and Right Angle Forceps

MIXTER-O'SHAUGNESSY Forceps

Catalog Number	Length (in.)
BJ050R	7 1/2



BJ050R



BJ050R

FINOCHIETTO Forceps

Catalog Number	Length (in.)
BJ052R	9 5/8

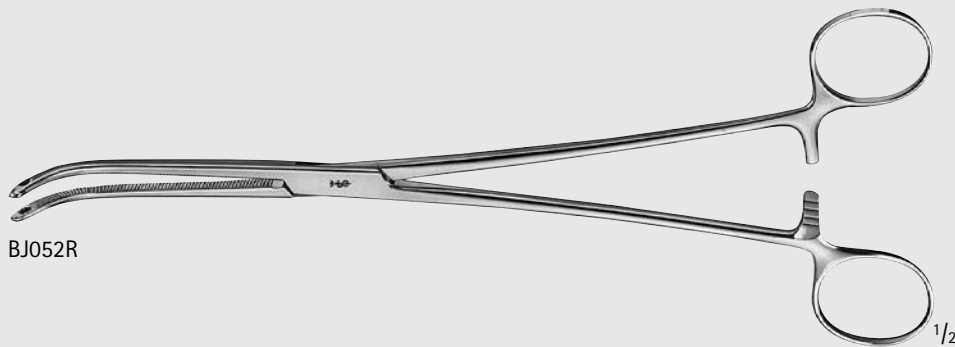

BJ052R



BJ052R



General Surgery

Dissecting and Right Angle Forceps

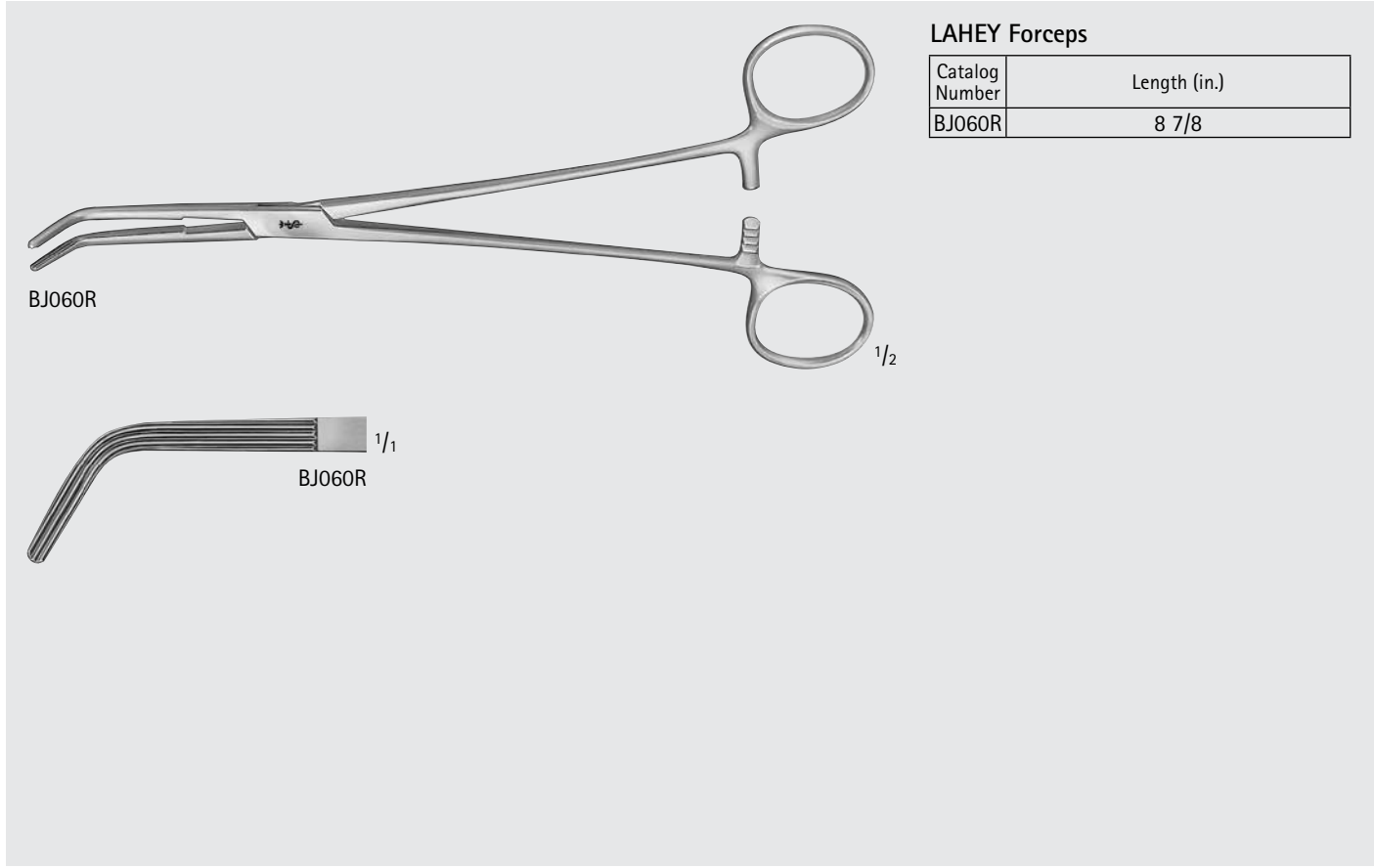

LAHEY Forceps

Catalog Number	Length (in.)
BJ060R	8 7/8

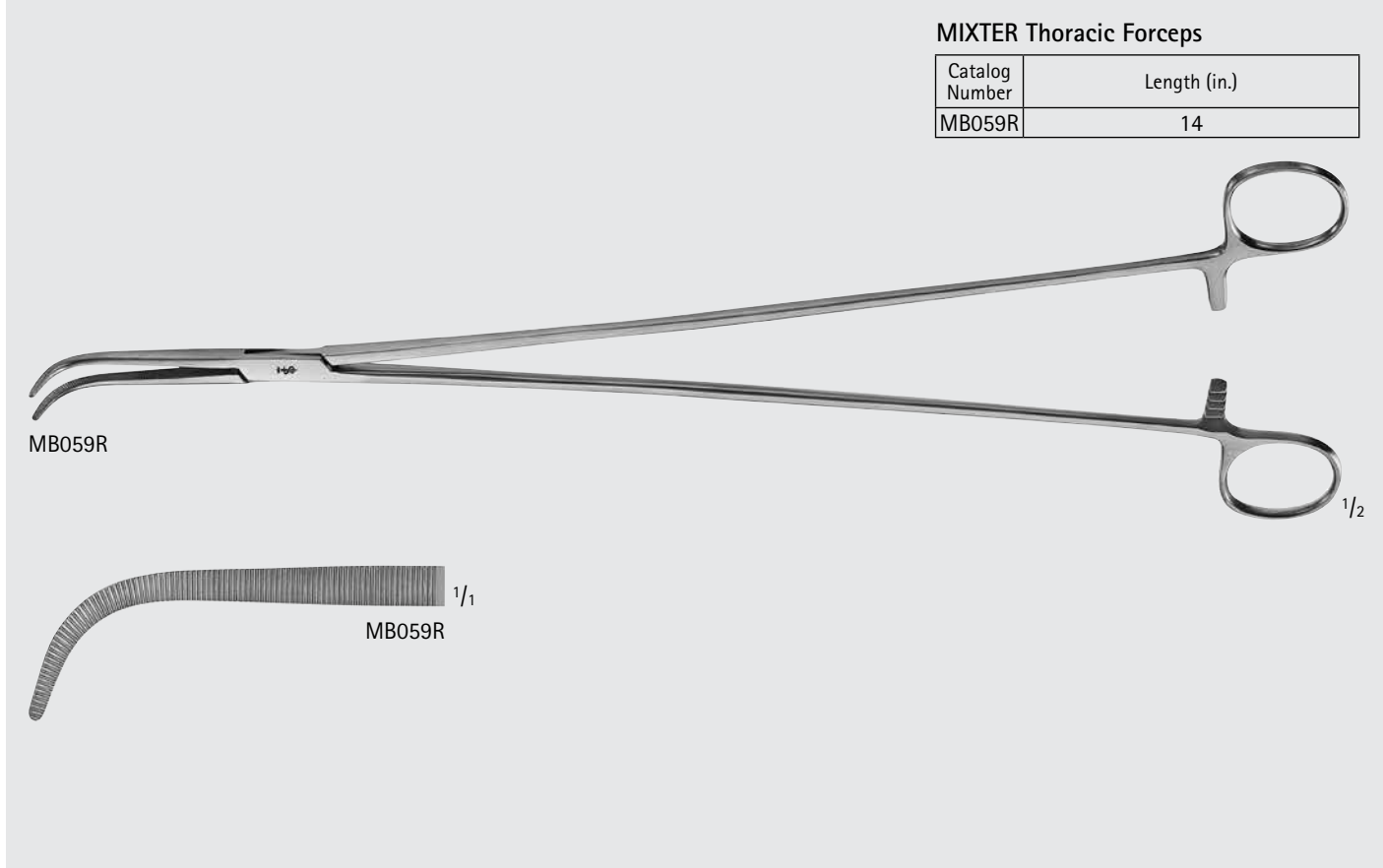

MIXTER Thoracic Forceps

Catalog Number	Length (in.)
MB059R	14

General Surgery

Dissecting and Right Angle Forceps

MIXTER Forceps, Longitudinal Serrations

Catalog Number	Length (in.)
BJ061R	8 3/4
BJ062R	9 3/4
BJ073R	11 1/2

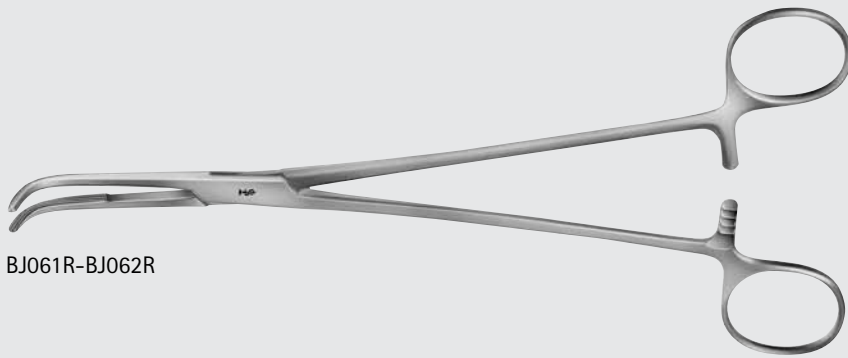

BJ061R-BJ062R



BJ061R



BJ062R

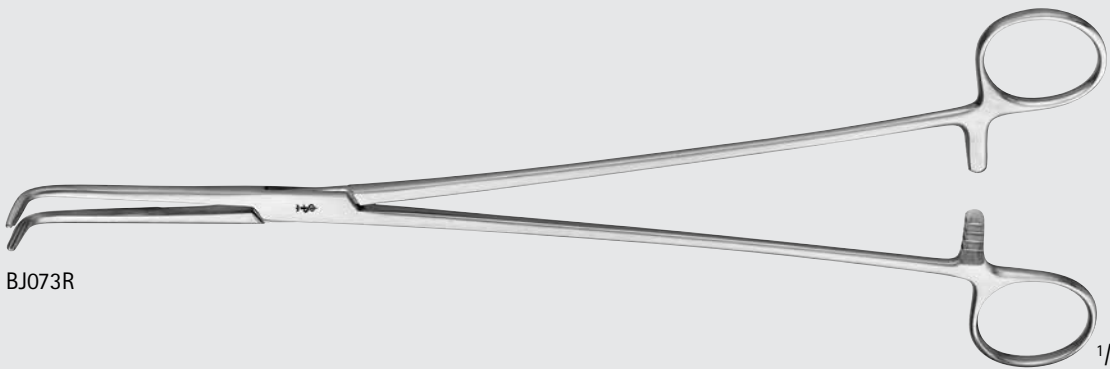

BJ073R



BJ073R



INCHES

General Surgery

Dissecting and Right Angle Forceps

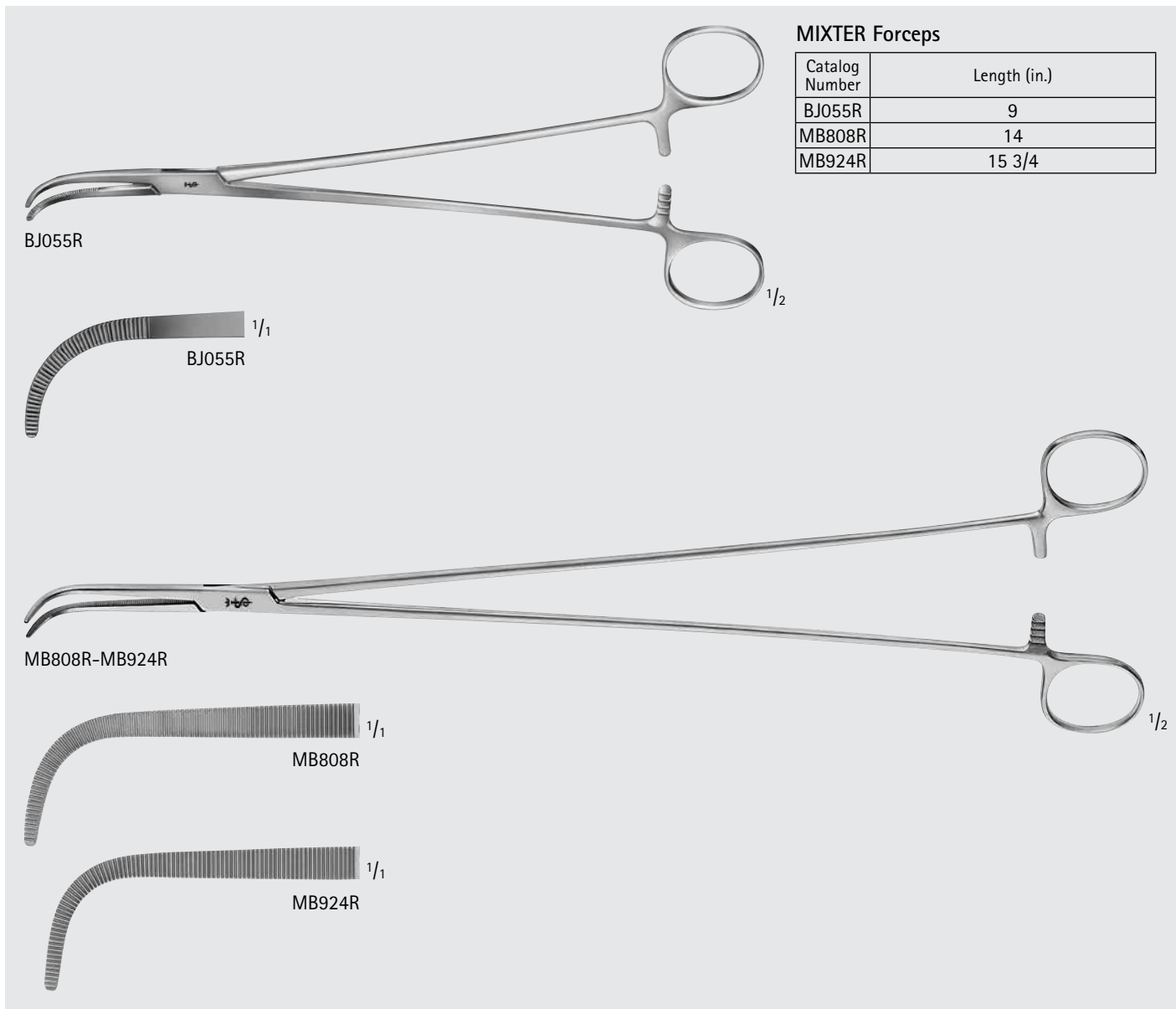

MIXTER Forceps

Catalog Number	Length (in.)
BJ055R	9
MB808R	14
MB924R	15 3/4

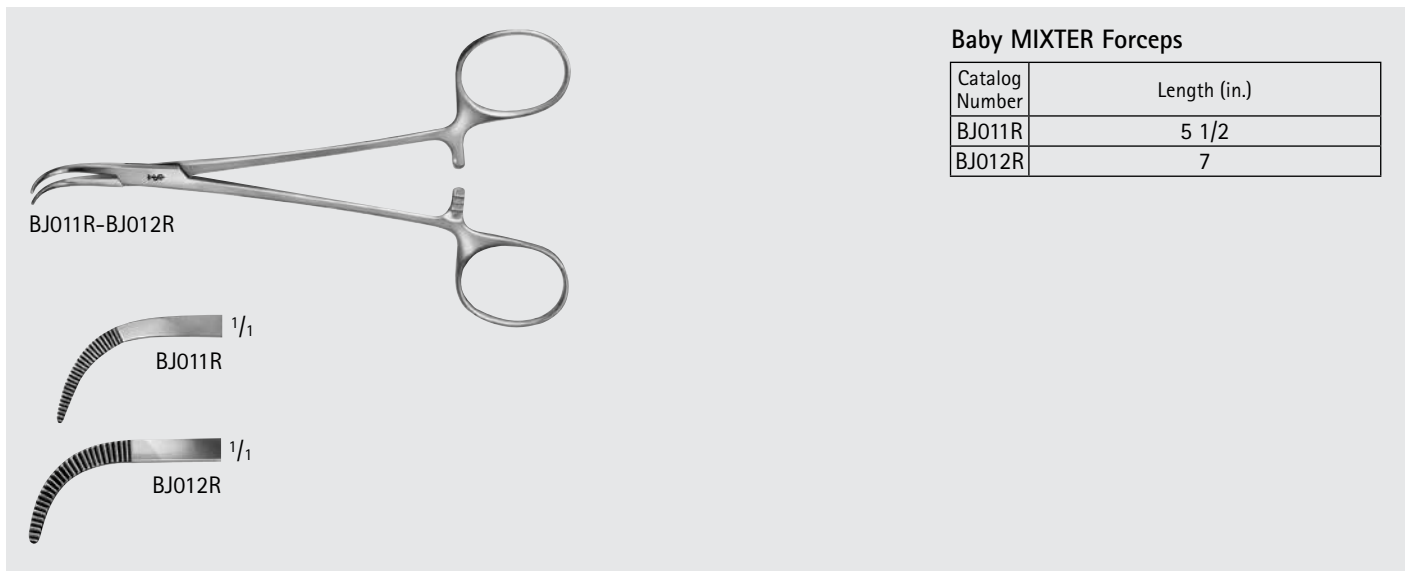

Baby MIXTER Forceps

Catalog Number	Length (in.)
BJ011R	5 1/2
BJ012R	7

General Surgery

Dissecting and Right Angle Forceps

GENERAL SURGERY

HARRINGTON-MIXTER Forceps, Longitudinal Serrations

Catalog Number	Length (in.)
BJ072R	12 1/2

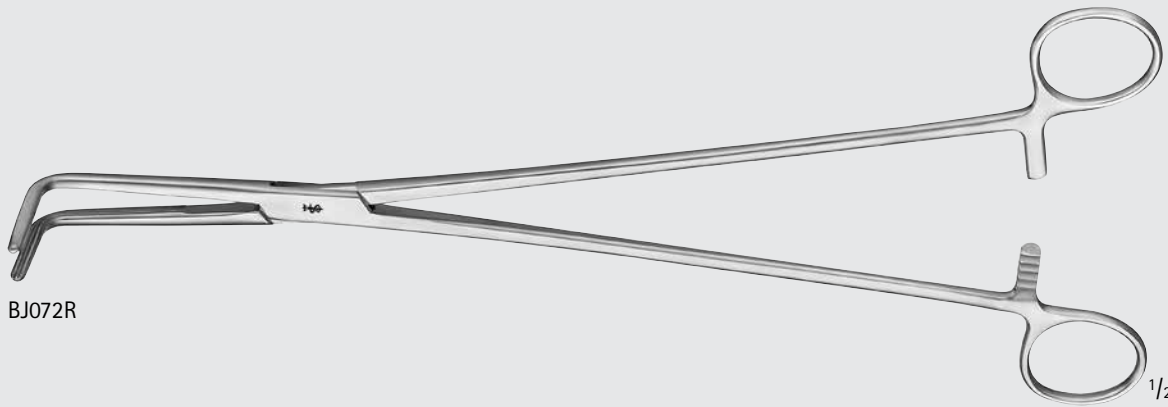

BJ072R

1/2

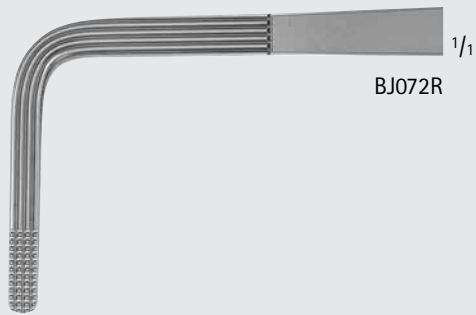

BJ072R

1/1

WIKSTROEM Forceps

Catalog Number	Length (in.)
BJ051R	8



BJ051R

1/2



BJ051R

1/1



INCHES

General Surgery

Dissecting and Right Angle Forceps



LAWRENCE Forceps

Catalog Number	Length (in.)
BJ070R	10 5/8

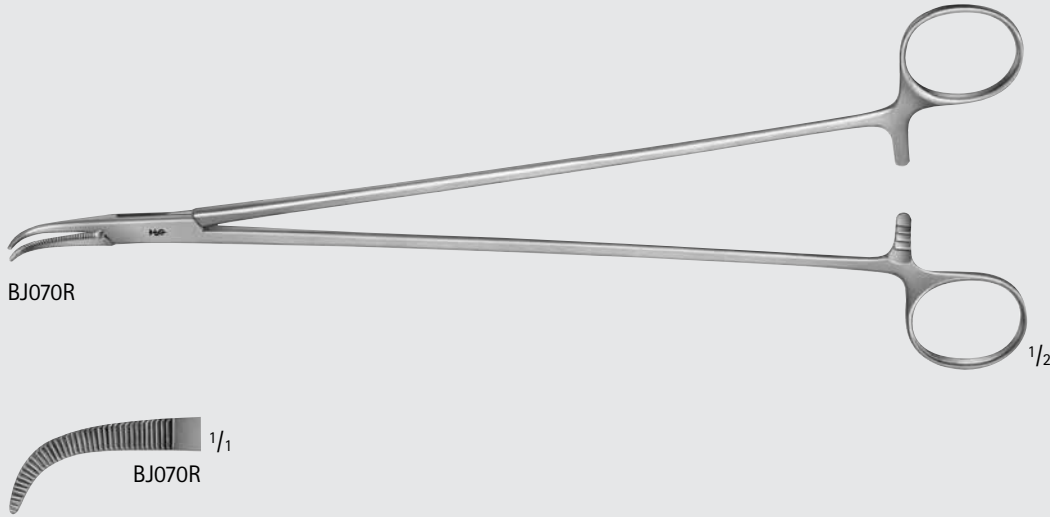

REINHOFF Swan Neck Clamp

Catalog Number	Tip	Jaw	Handle	Length (in.)
US116	SERR	CVD	CVD	10 1/4

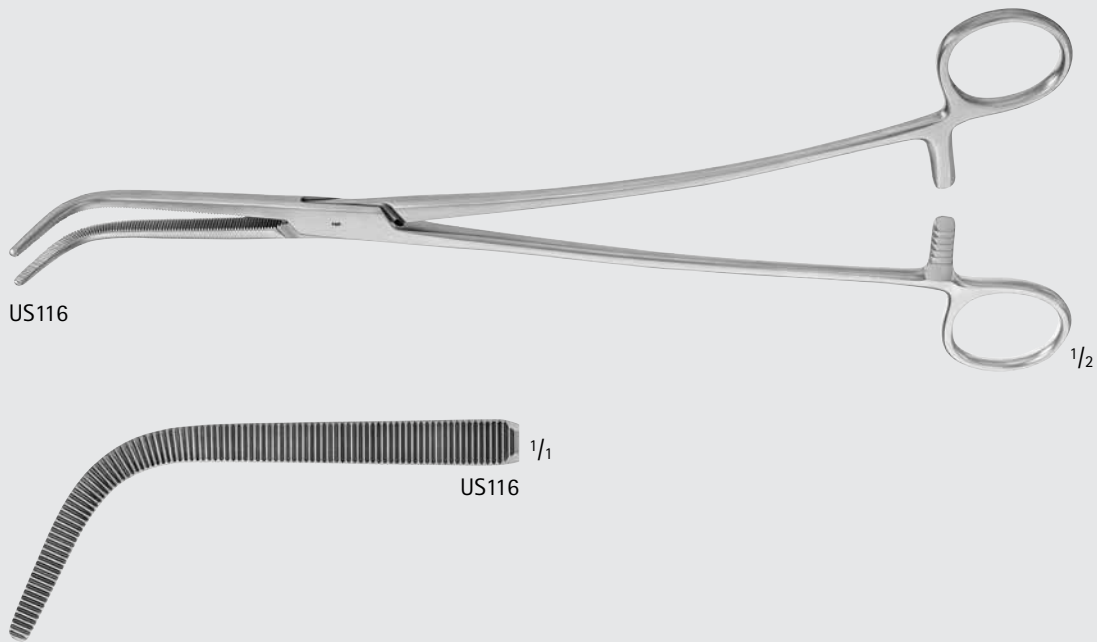

General Surgery

Dissecting and Right Angle Forceps

KIEBACK Forceps

Catalog Number	Jaw	Length (in.)
BJ075R	CVD, LONGITUDINAL SERR	9 1/4

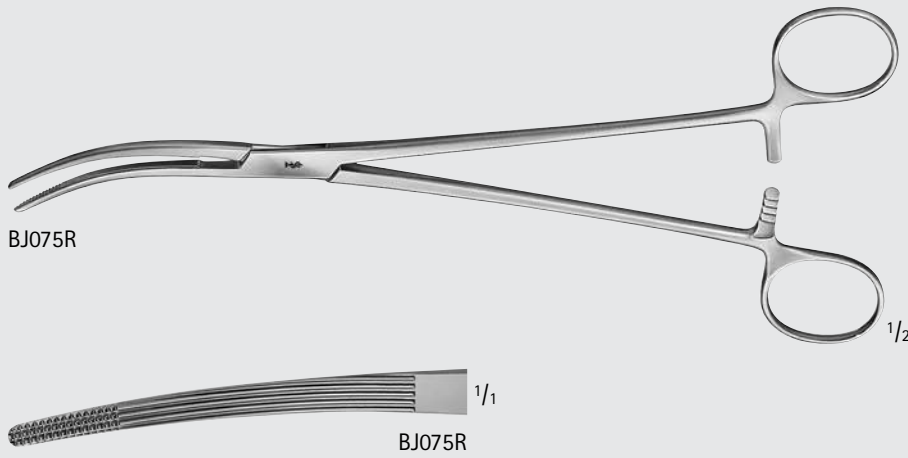

COLLIER-ANDERSON Forceps

Catalog Number	Jaw	Length (in.)
MB897R	CVD, LONGITUDINAL SERR	10
MB898R	CVD, LONGITUDINAL SERR	11

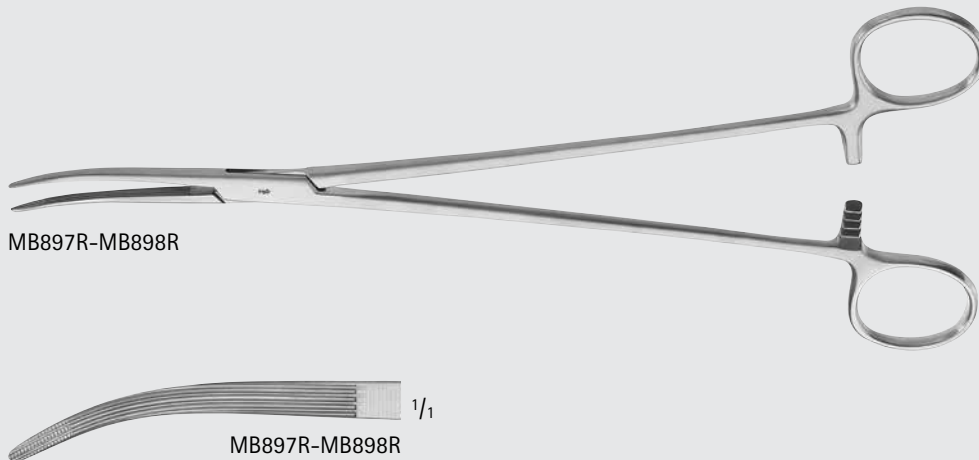

DEBAKEY-COLLIER Forceps

Catalog Number	Jaw	Length (in.)
MB899R	CVD, SERR	8

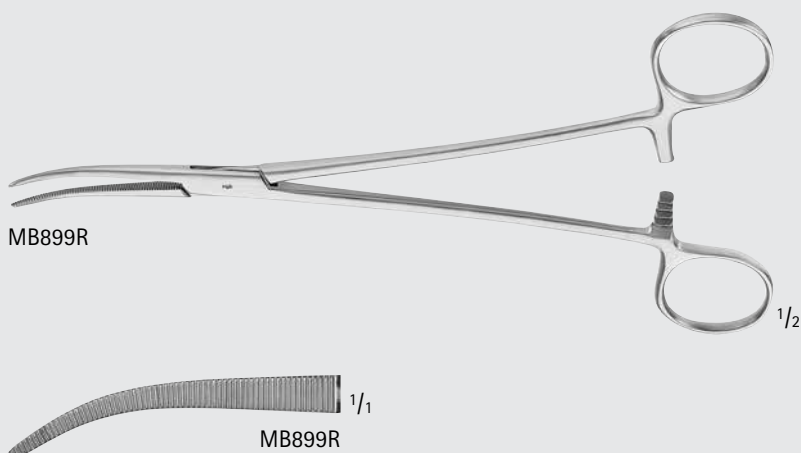

General Surgery

Towel and Tubing Clamps



BF407R

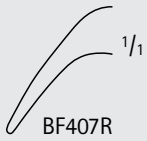

BF407R

JONES Towel Clamp

Catalog Number	Length (in.)
BF407R	3 1/4

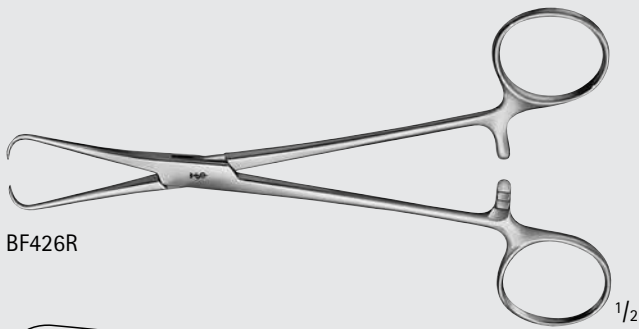

BF426R

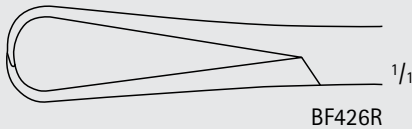

BF426R

BERNHARD Towel Clamp

Catalog Number	Length (in.)
BF426R	6 1/4



BF431R-BF433R



BF431R

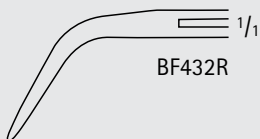

BF432R

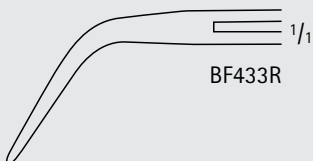

BF433R

BACKHAUS Towel Clamp

Catalog Number	Length (in.)
BF431R	3 1/2
BF432R	4 1/4
BF433R	5 1/4

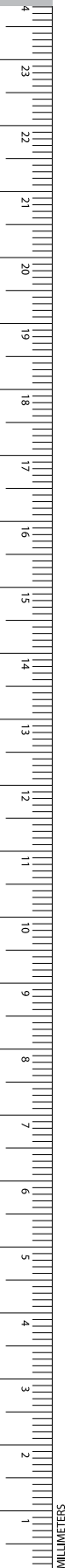

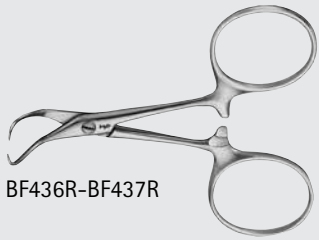

BF436R-BF437R

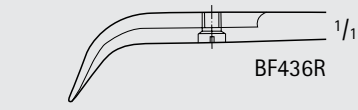

BF436R

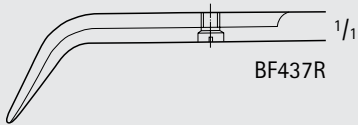

BF437R

BACKHAUS Towel Clamp, W/ Screw

Catalog Number	Length (in.)
BF436R	3 1/8
BF437R	4 1/8

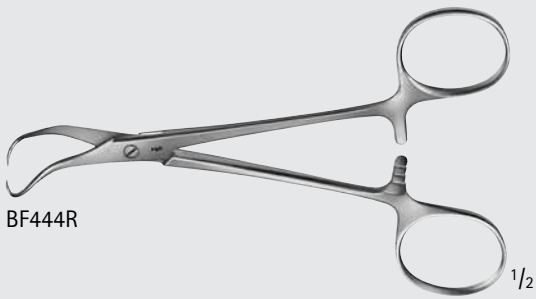

BF444R

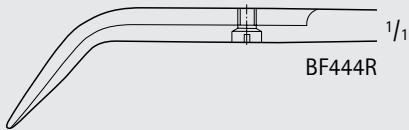

BF444R

BACKHAUS-KOCHER Towel Clamp, W/ Screw

Catalog Number	Length (in.)
BF444R	5 1/4



BF448R

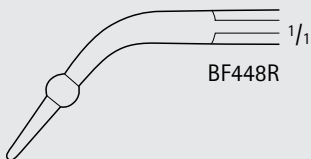

BF448R

ROEDER Towel Clamp, W/ Ball On Jaws

Catalog Number	Length (in.)
BF448R	5 1/4



INCHES

General Surgery

Towel and Tubing Clamps



BF464R

1/2



BF464R

1/1

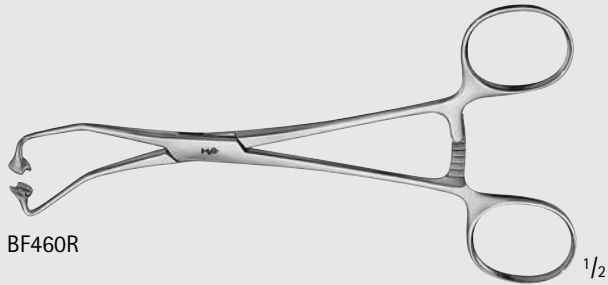

BF460R

1/2

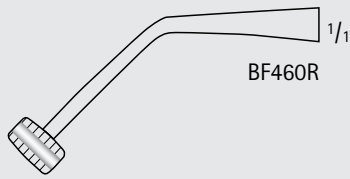

BF460R

1/1

Towel Clamp, Paper Drape

Catalog Number	Length (in.)
BF464R	5 1/2
BF460R	6

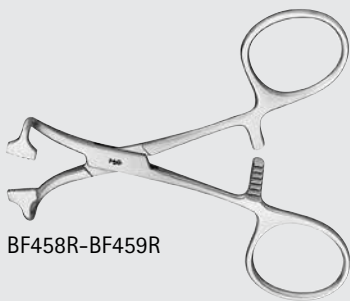

BF458R-BF459R

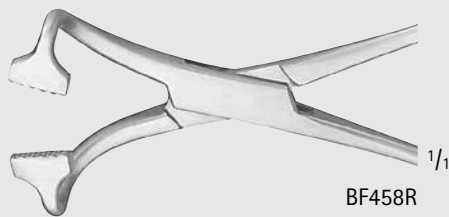

BF458R

1/1

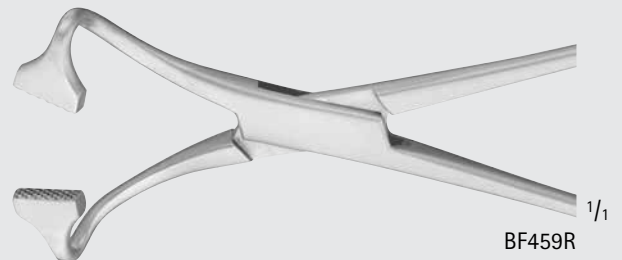

BF459R

1/1

Non-Perforating Towel Forceps

Catalog Number	Length (in.)
BF458R	4
BF459R	5 1/2

General Surgery

Towel and Tubing Clamps

LORNA Non-Perforating Towel Clamp

Catalog Number	Length (in.)
BF461R	3 3/4
BF463R	5 1/8

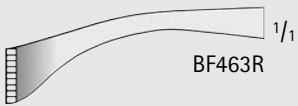
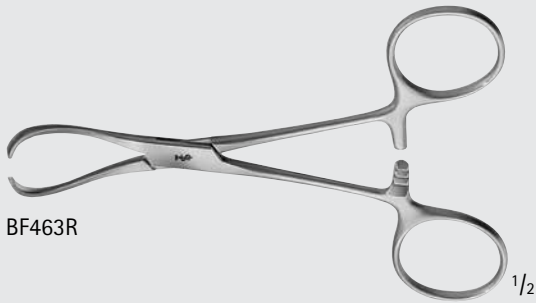

Tubing Clamp, W/ Guard

Catalog Number	Jaw	Length (in.)
MD652	SERR	6
MD653	SERR	7
MD654	SERR	7 7/8

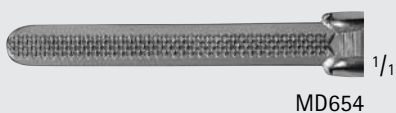
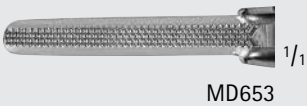
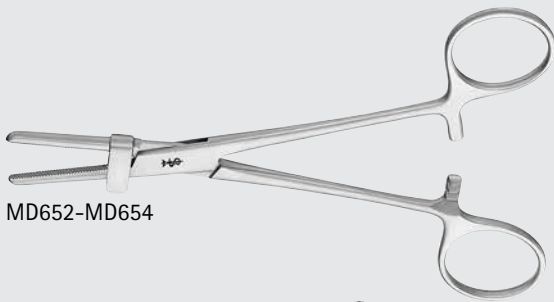

General Surgery

Skin Hooks

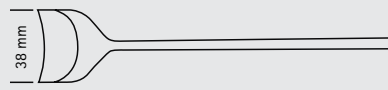
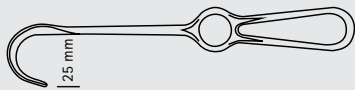

Dimensions for blade size of retractors
 1st number = depth Example: 25 x 38 mm
 2nd number = width



OL620R, MA185R, OL622R-OL624R, MD581



JOSEPH Skin Hook

Catalog Number	Tip	Prongs	Tip Size (mm)	Length (in.)
OL620R	SHARP	1	-	6 1/2
MA185R	SHARP	2	2	6 1/4
OL622R	SHARP	2	3	6 1/2
OL623R	SHARP	2	6	6 1/2
OL624R	SHARP	2	8	6 1/2
MD581	SHARP	2	10	6 1/2



OL621R

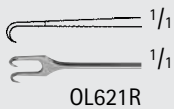

FREER Double Hook

Catalog Number	Tip	Tip Size (mm)	Length (in.)
OL621R	SHARP	2.0 x 3.2	6



OA332R-OA333R

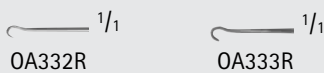

GRAEFE Hook

Catalog Number	Tip	Length (in.)
OA332R	SHARP	5
OA333R	BLUNT	5



OA334R-OA335R

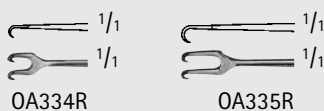

GUTHRIE Double Hook

Catalog Number	Tip	Length (in.)
OA334R	SHARP	5
OA335R	SHARP	5 1/8

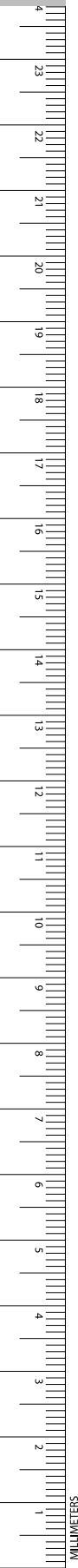



OA336R-OA338R

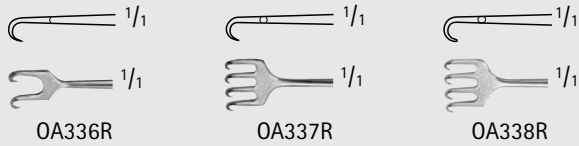

ROLLET Hook Retractor

Catalog Number	Tip	Blade End	Tip Size (mm)	Length (in.)
OA336R	SHARP	2 PRONGS	2.2 x 4.5	5 1/8
OA337R	SHARP	4 PRONGS	2.5 x 7.0	5 1/4
OA338R	BLUNT	4 PRONGS	2.2 x 7.0	5 1/4



OL615R

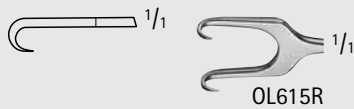

MCINDOE Hook

Catalog Number	Tip	Blade End	Tip Size (mm)	Length (in.)
OL615R	SHARP	2 PRONGS	9	6



OA340R

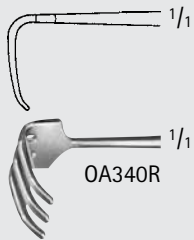

PAUL Tendon Hook

Catalog Number	Tip	Blade End	Tip Size (mm)	Length (in.)
OA340R	BLUNT	3 PRONGS	11 x 8	4 3/4



OA351R

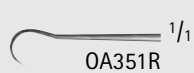

JAEGER Hook Retractor, Fine

Catalog Number	Tip	Length (in.)
OA351R	SHARP	5 1/4

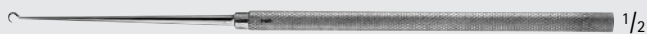

OL610R

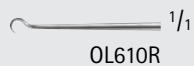

KILNER Skin Hook

Catalog Number	Tip	Length (in.)
OL610R	SHARP	6 1/4



OL611R-OL612R



GILLIES Skin Hook

Catalog Number	Tip	Hook End	Length (in.)
OL611R	SHARP	SMALL	7
OL612R	SHARP	LARGE	7

General Surgery

Skin Hooks



COTTLE Hook

Catalog Number	Tip	Hook End	Length (in.)
OL617R	SHARP	ANG	6 1/4
OL619R	SHARP	HVY-CVD	6 1/4



KLEINERT-KUTZ Skin Hook

Catalog Number	Size	Tip	Tip Size (mm)	Length (in.)
OL601R	1	SHARP	2.5	6 1/4
OL602R	2	SHARP	4.2	6 1/4
OL603R	3	SHARP	4.8	6 1/4



Prong Micro Hooks

Catalog Number	Tip	Tip Size (mm)	Length (in.)
MB885R	SHARP	1	5 5/8
MB886R	SHARP	2	5 5/8
MB887R	BLUNT	2	5 5/8
MB888R	SHARP	2	5 5/8
MB889R	SHARP	5	5 5/8
MB890R	SHARP	7	5 5/8
MB891R	SHARP	10	5 5/8



BT075R

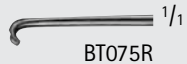

BT075R

BROM Vein Hook

Catalog Number	Length (in.)
BT075R	6 3/4



BT100R

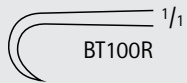

BT100R

BERGMANN Hook

Catalog Number	Tip	Tip Size (mm)	Length (in.)
BT100R	SHARP	7	5 1/2



BT161R

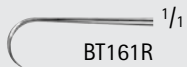

BT161R

EMMET Fistula Hook

Catalog Number	Tip	Length (in.)
BT161R	SHARP	8 3/4



BT166R

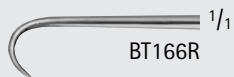

BT166R



BT167R

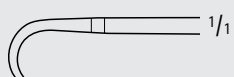

BT167R

SIMON Fistula Hook

Catalog Number	Tip	Blade End	Length (in.)
BT166R	SHARP	1 PRONG	8 3/4
BT167R	SHARP	2 PRONGS	8 3/4

General Surgery

Hand Held Retractors



Baby SENN-MILLER Retractor, Flat Handle

Catalog Number	Tip	Blade End	Blade Size (mm)	Length (in.)
BT006R	SHARP	3 PRONGS	8 x 7 / 22 x 7	6 1/8
BT007R	BLUNT	3 PRONGS	8 x 7 / 22 x 7	6 1/8

SENN-MILLER Retractor

Catalog Number	Tip	Blade End	Blade Size (mm)	Length (in.)
BT008R	SHARP	3 PRONGS	8 x 7 / 18 x 5.5	6 1/2

SENN Retractor, Round Tapered Handle

Catalog Number	Tip	Blade End	Blade Size (mm)	Length (in.)
MG276R	SHARP	3 PRONGS	9 x 10 / 22 x 7	6 1/4
MG277R	BLUNT	3 PRONGS	9 x 10 / 22 x 7	6 1/4



RAGNELL Retractor

Catalog Number	Blade Size (mm)	Length (in.)
BT004R	3 x 5 / 6.3 x 14	6
MG274R	3 x 11 / 5.4 x 17	6

DAVIS Double Ended Retractor

Catalog Number	Blade Size (mm)	Length (in.)
MG475R	19 x 9 / 23 x 6.4	6

Double Ended Retractor

Catalog Number	Blade Size (mm)	Length (in.)
BT187R	20 x 15 / 20 x 19	8

GOELET Retractor

Catalog Number	Blade Size (mm)	Length (in.)
MD497	30 x 32 / 35 x 40	7 1/2

General Surgery

Hand Held Retractors

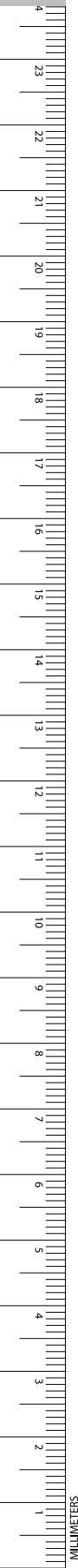

BT010R



BT010R

LUER Retractor

Catalog Number	Blade Size (mm)	Length (in.)
BT010R	10 x 8 / 12 x 11	4 1/4



BT020R

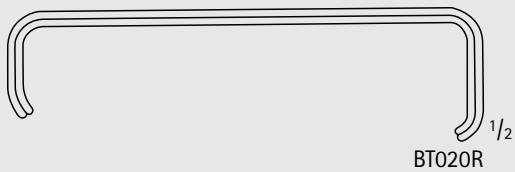

BT020R



BT021R

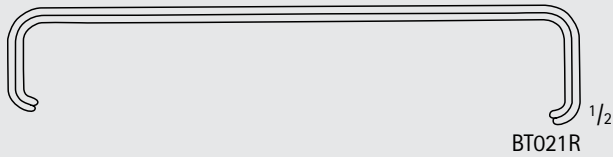

BT021R

FARABEUF Retractor, 2/Set

Catalog Number	Blade Size (mm)	Length (in.)
BT020R	25 x 10 / 32 x 12 22 x 10 / 29 x 12	5
BT021R	23 x 16 / 28 x 16 19 x 16 / 24 x 16	6



MB984R

MAYO-COLLINS Retractor, 2/Set

Catalog Number	Blade Size (mm)	Length (in.)
MB984R	31 x 20 / 30 x 18 28 x 19 / 26 x 17	5 7/8



BT022R

1/2



BT022R

1/2

COLLIN Retractor, 2/Set

Catalog Number	Blade Size (mm)	Length (in.)
BT022R	21 x 14 / 32 x 16 17 x 14 / 28 x 16	6



BT012R

1/2

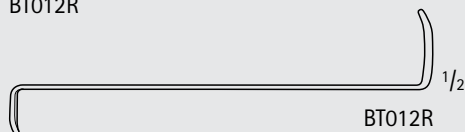

BT012R

1/2

CRILE Retractor

Catalog Number	Blade Size (mm)	Length (in.)
BT012R	11 x 4 / 19 x 6	4 1/4

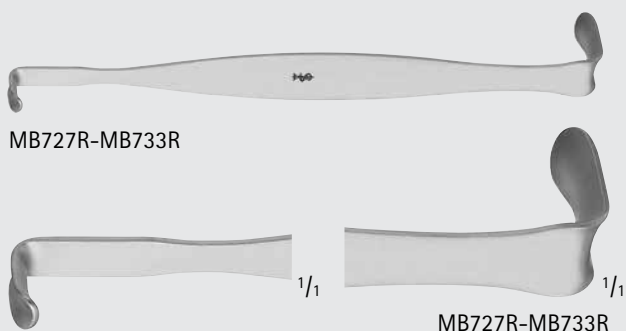

MB727R-MB733R

1/1

1/1

MB727R-MB733R

CRILE Retractor

Catalog Number	Size	Blade Size (mm)	Length (in.)
MB727R	1	3 x 11 / 6 x 21	4 1/4
MB728R	2	6 x 13 / 10 x 21	6 1/8
MB729R	3	16 x 25 / 17 x 35	6 1/4
MB730R	4	22 x 29 / 29 x 44	7
MB731R	5	29 x 41 / 35 x 51	7
MB732R	6	32 x 64 / 35 x 70	7 7/8
MB733R	7	41 x 76 / 51 x 79	8 7/8

General Surgery

Hand Held Retractors



BT011R

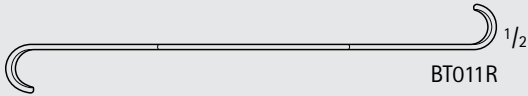

BT011R

ROSE Tracheal Retractor

Catalog Number	Blade Size (mm)	Length (in.)
BT011R	10 x 12 / 11 x 15	5 1/8



MG474R

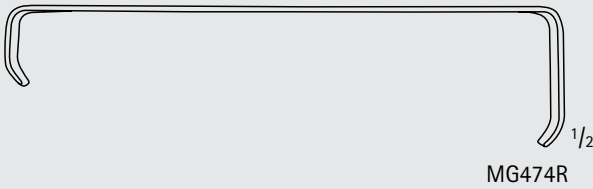

MG474R

Children's Hospital Retractor

Catalog Number	Blade Size (mm)	Length (in.)
MG474R	11 x 22 / 14 x 35	4 1/2



BT025R

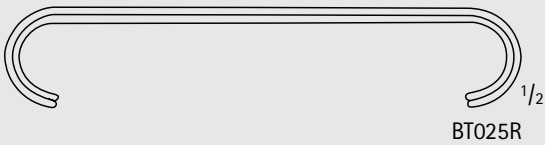

BT025R



BT026R

PARKER Retractor, 2/Set

Catalog Number	Blade Size (mm)	Length (in.)
BT025R	22 x 15 / 22 x 15 18 x 15 / 18 x 15	5 1/4
BT026R	31 x 25 / 27 x 25 31 x 25 / 27 x 25	7



BT034R-BT036R

ROUX Retractor

Catalog Number	Blade Size (mm)	Length (in.)
BT034R	20 x 22 / 25 x 29	6
BT035R	25 x 26 / 30 x 38	6 1/4
BT036R	28 x 29 / 33 x 44	6 3/4



BT034R

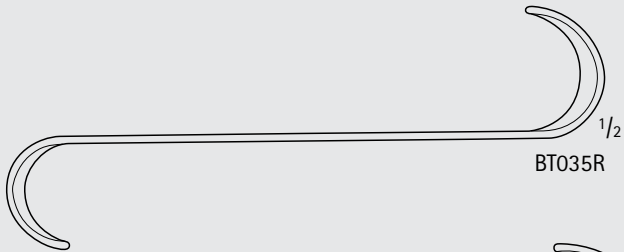

BT035R



BT036R



INCHES

General Surgery

Hand Held Retractors

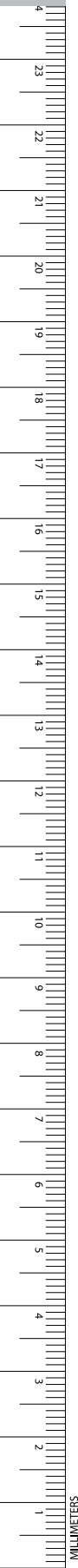

BT030R-BT033R $\frac{1}{2}$

BT031R $\frac{1}{2}$

BT032R $\frac{1}{2}$

BT033R $\frac{1}{2}$

ROUX Retractor

Catalog Number	Blade Size (mm)	Length (in.)
BT030R	COMPLETE SET BT031R-BT033R	-
BT031R	21 x 22 / 27 x 28	5 3/4
BT032R	26 x 26 / 32 x 26	6 1/8
BT033R	30 x 30 / 36 x 44	6 1/2

MB584R-MB585R $\frac{1}{2}$

MB584R $\frac{1}{2}$

MB585R $\frac{1}{2}$

ROUX Retractor

Catalog Number	Blade Size (mm)	Length (in.)
MB584R	25 x 26 / 30 x 37	6 1/2
MB585R	28 x 28 / 29 x 40	6 1/2

BT029R $\frac{1}{2}$

BT029R $\frac{1}{2}$

ROUX Retractor, Long

Catalog Number	Blade Size (mm)	Length (in.)
BT029R	28 x 28 / 46 x 28	7 1/2

General Surgery

Hand Held Retractors



BT040R

MATHIEU Retractor, 2/Set

Catalog Number	Blade Size (mm)	Length (in.)
BT040R	42 x 13 / 41 x 13 45 x 25 / 40 x 25	7 7/8

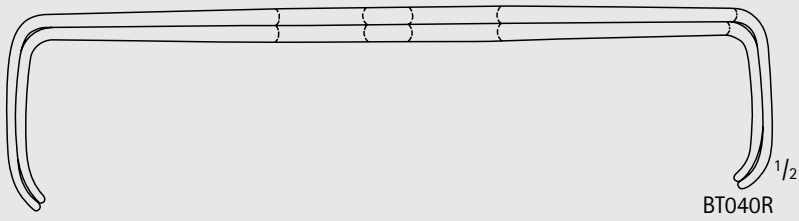

BT040R



BT041R

US Army Retractor, 2/Set

Catalog Number	Blade Size (mm)	Length (in.)
BT041R	26 x 15 / 22 x 15 43 x 15 / 39 x 15	8 3/4



BT041R



General Surgery

Hand Held Retractors

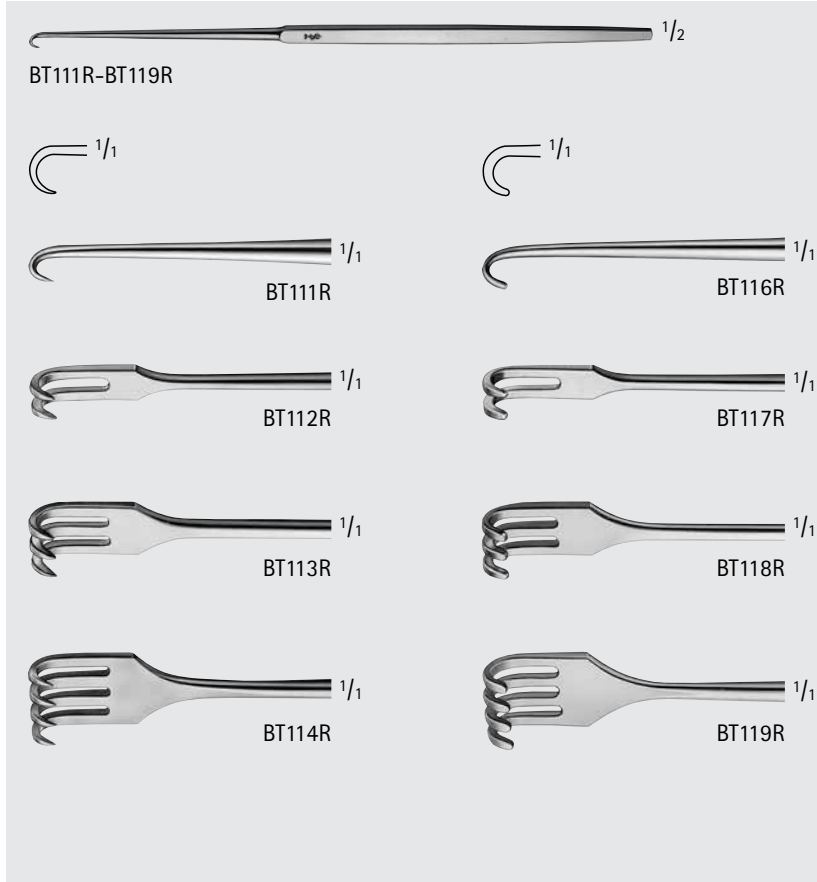

Hook, Small Curve

Catalog Number	Tip	Blade End	Blade Size (mm)	Length (in.)
BT111R	SHARP	1 PRONG	-	6 1/2
BT112R	SHARP	2 PRONGS	5.0 x 4.2	6 1/2
BT113R	SHARP	3 PRONGS	5.0 x 7.0	6 1/2
BT114R	SHARP	4 PRONGS	5.0 x 9.5	6 1/2
BT116R	BLUNT	1 PRONG	-	6 1/2
BT117R	BLUNT	2 PRONGS	4.5 x 4.2	6 1/2
BT118R	BLUNT	3 PRONGS	4.5 x 7.0	6 1/2
BT119R	BLUNT	4 PRONGS	4.5 x 9.0	6 1/2

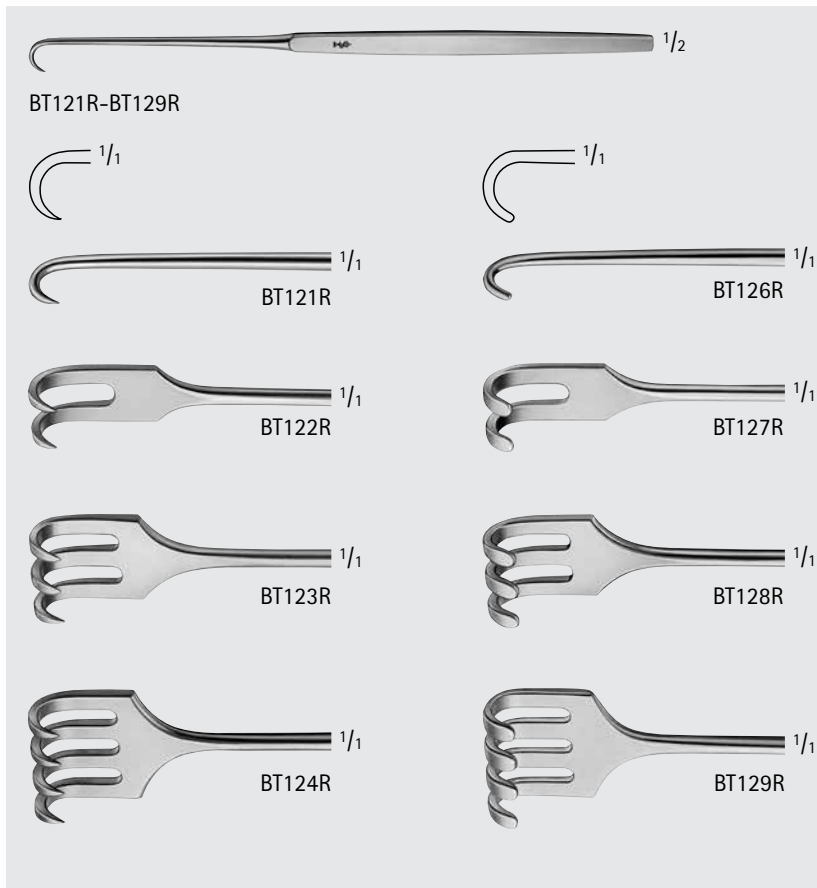

Hook, Large Curve

Catalog Number	Tip	Blade End	Blade Size (mm)	Length (in.)
BT121R	SHARP	1 PRONG	-	6 1/2
BT122R	SHARP	2 PRONGS	7.5 x 7.5	6 1/2
BT123R	SHARP	3 PRONGS	7.5 x 10.0	6 1/2
BT124R	SHARP	4 PRONGS	7.5 x 14.0	6 1/2
BT126R	BLUNT	1 PRONG	-	6 1/2
BT127R	BLUNT	2 PRONGS	6.8 x 7.5	6 1/2
BT128R	BLUNT	3 PRONGS	6.8 x 10.0	6 1/2
BT129R	BLUNT	4 PRONGS	6.8 x 14.0	6 1/2

CRILE Hook and Dissector

Catalog Number	Length (in.)
MB060R	11 3/4



KLAPP Tendon Hook

Catalog Number	Tip	Blade End	Blade Size (mm)	Length (in.)
BT172R	BLUNT	4 PRONGS	15 x 11	6 7/8

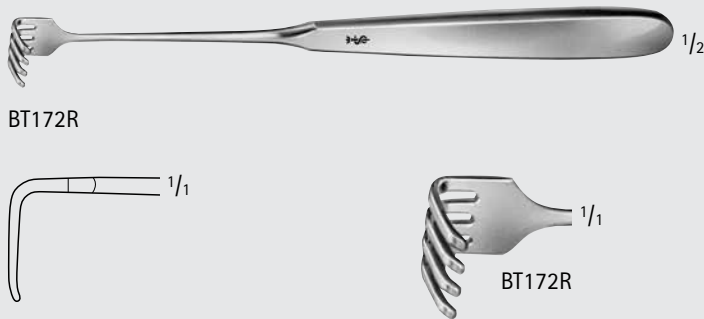

Vein Retractor

Catalog Number	Blade Size (mm)	Length (in.)
BT179R	10 x 13	6 1/4



KOENIG Vein Retractor

Catalog Number	Blade Size (mm)	Length (in.)
BT182R	13 x 13	7
BT183R	12 x 16	7

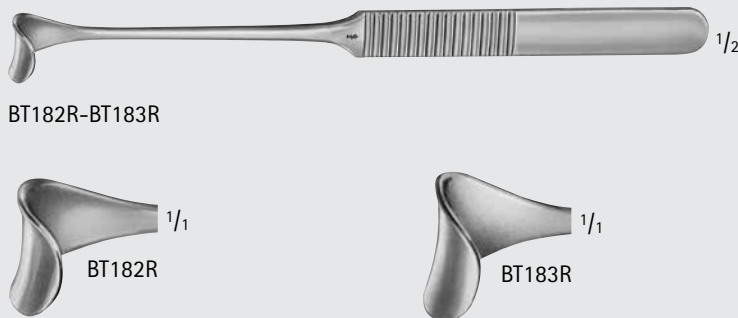

General Surgery

Hand Held Retractors

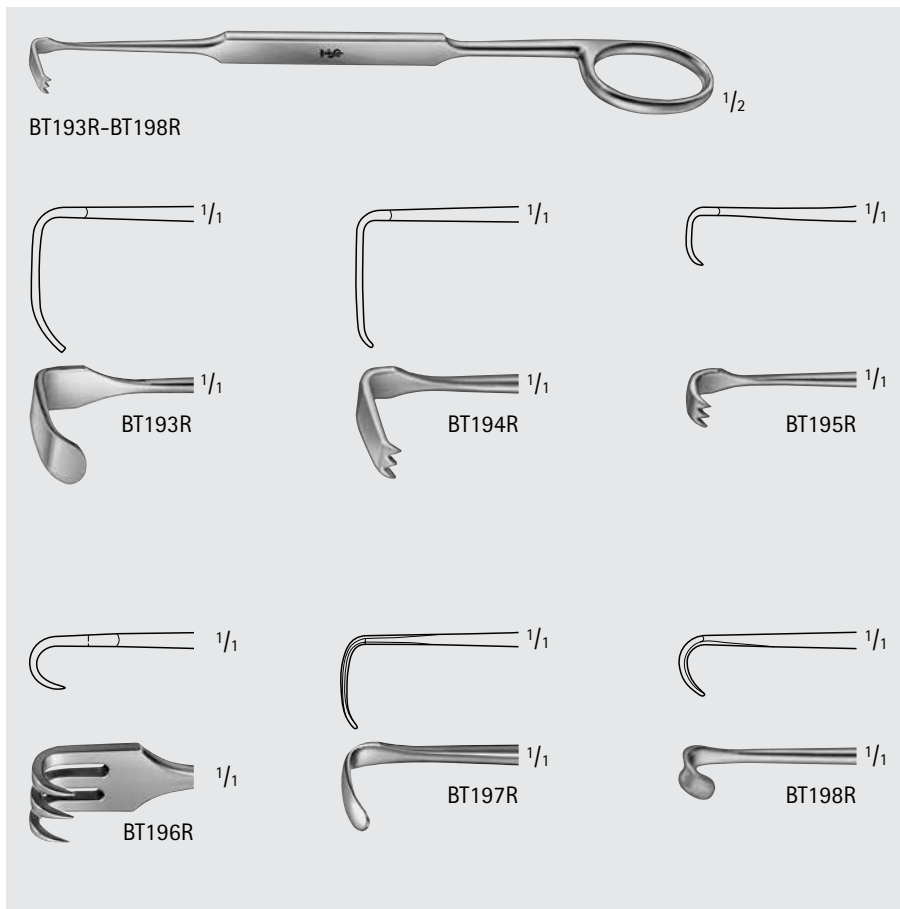
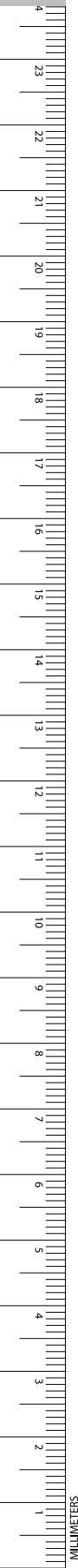

MEYERDING Thumb Retractor

Catalog Number	Blade Size	Size (#)	Blade Size (mm)	Length (in.)
BT193R	A	1	18 x 7	7
BT194R	B	2	16 x 5	7
BT195R	C	3	7 x 4	7
BT196R	D	4	5 x 10	7
BT197R	E	5	11 x 4	7
BT198R	F	6	6 x 4	7



CUSHING-KOCHER Retractor

Catalog Number	Blade Size (mm)	Length (in.)
BT190R	10 x 10	6 7/8

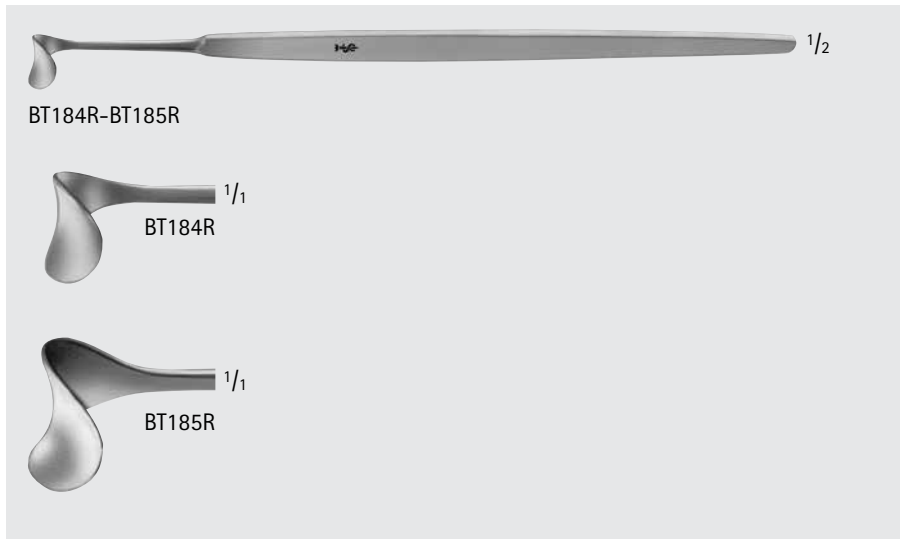

CUSHING Vein Retractor

Catalog Number	Blade Size (mm)	Length (in.)
BT184R	10 x 13	8
BT185R	14 x 18	8

**CUSHING Vein Retractor
(continued)**

Catalog Number	Blade Size (mm)	Length (in.)
BT200R	14 x 11	9 3/4
BT202R	22 x 15	9 3/4



BT200R-BT202R



BT200R



BT202R

CUSHING Vein Retractor

Catalog Number	Blade Size (mm)	Length (in.)
MB912R	14	12 1/2
MB913R	14	14
MB914R	14	16



MB912R-MB914R



MB912R-MB914R

GIL VERNET Retractor, Malleable

Catalog Number	Blade Size (mm)	Length (in.)
MB766R	9	11 1/4
MB767R	11	11 1/4
MB768R	13	11 1/4
MB769R	18	11 1/4



MB766R-MB769R



MB766R-MB769R



INCHES

General Surgery

Hand Held Retractors



BT221R

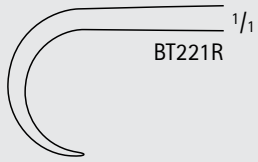

BT221R



BT222R-BT230R

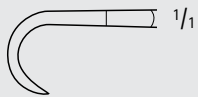

1/1

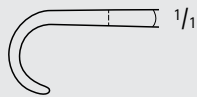

1/1



BT222R



BT227R



BT223R



BT228R



BT224R



BT229R



BT225R



BT230R

VOLKMANN Retractor

Catalog Number	Tip	Blade End	Blade Size (mm)	Length (in.)
BT221R	SHARP	1 PRONG	8.5 x 8	8 3/4
BT222R	SHARP	2 PRONGS	9 x 8	8 7/8
BT223R	SHARP	3 PRONGS	9 x 13	8 7/8
BT224R	SHARP	4 PRONGS	9 x 19	8 7/8
BT225R	SHARP	6 PRONGS	9 x 29	8 7/8
BT227R	BLUNT	2 PRONGS	8.5 x 12	8 7/8
BT228R	BLUNT	3 PRONGS	8.5 x 13	8 7/8
BT229R	BLUNT	4 PRONGS	8.5 x 19	8 7/8
BT230R	BLUNT	6 PRONGS	8.5 x 29	8 7/8





BT240R-BT241R

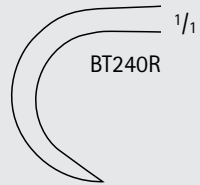

BT240R

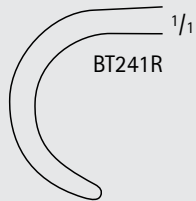

BT241R



BT242R-BT265R

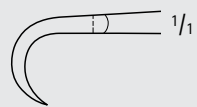

BT242R

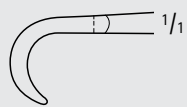

BT257R

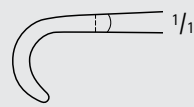

BT252R



BT243R



BT259R



BT253R



BT244R



BT260R



BT254R



BT246R



BT261R



BT256R



BT248R



BT265R



BT258R

VOLKMANN Retractor, Small

Catalog Number	Tip	Blade End	Blade Size (mm)	Length (in.)
BT240R	SHARP	1 PRONG	-	8 3/4
BT241R	BLUNT	1 PRONG	-	8 3/4
BT242R	SHARP	2 PRONGS	9 x 8	8 3/4
BT243R	SHARP	3 PRONGS	9 x 13	8 3/4
BT244R	SHARP	4 PRONGS	9 x 19	8 3/4
BT246R	SHARP	6 PRONGS	9 x 29	8 3/4
BT248R	SHARP	8 PRONGS	9 x 40	8 3/4
BT257R	SEMI-S	2 PRONGS	8.5 x 8	8 3/4
BT259R	SEMI-S	3 PRONGS	8.5 x 13	8 3/4
BT260R	SEMI-S	4 PRONGS	8.5 x 19	8 3/4
BT261R	SEMI-S	6 PRONGS	8.5 x 29	8 3/4
BT265R	SEMI-S	8 PRONGS	8.5 x 40	8 3/4
BT252R	BLUNT	2 PRONGS	8 x 8	8 3/4
BT253R	BLUNT	3 PRONGS	8 x 13	8 3/4
BT254R	BLUNT	4 PRONGS	8 x 19	8 3/4
BT256R	BLUNT	6 PRONGS	8 x 29	8 3/4
BT258R	BLUNT	8 PRONGS	8 x 40	8 3/4



INCHES

General Surgery

Hand Held Retractors

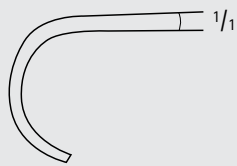
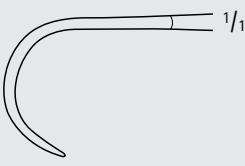
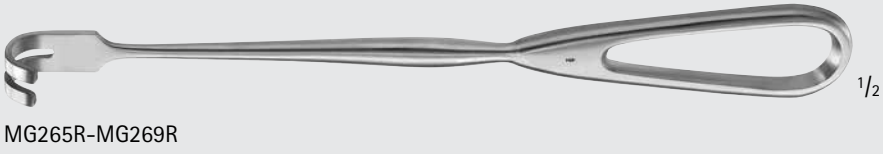
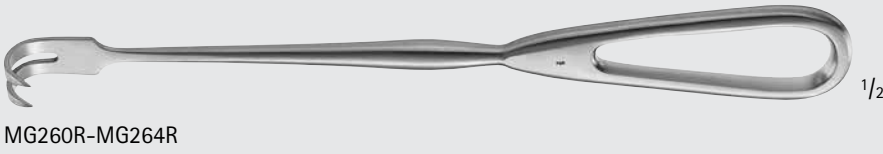
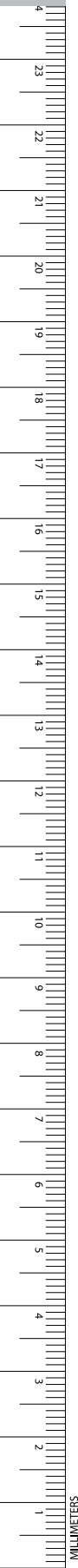

VOLKMANN Retractor, US Version

Catalog Number	Tip	Blade End	Blade Size (mm)	Length (in.)
MG260R	SHARP	2 PRONGS	20 x 11	8 3/4
MG261R	SHARP	3 PRONGS	20 x 18	8 3/4
MG262R	SHARP	4 PRONGS	20 x 26	8 3/4
MG264R	SHARP	6 PRONGS	20 x 40	8 3/4
MG265R	BLUNT	2 PRONGS	20 x 11	8 3/4
MG266R	BLUNT	3 PRONGS	20 x 18	8 3/4
MG267R	BLUNT	4 PRONGS	20 x 26	8 3/4
MG269R	BLUNT	6 PRONGS	20 x 40	8 3/4



BT262R-BT276R

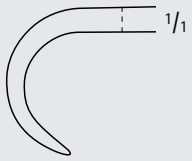

BT262R



BT263R



BT264R



BT266R

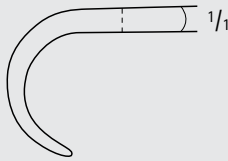

BT272R



BT273R



BT274R



BT276R

KOCHER Retractor, Large

Catalog Number	Tip	Blade End	Blade Size (mm)	Length (in.)
BT262R	SEMI-S	2 PRONGS	16 x 9	8 3/4
BT263R	SEMI-S	3 PRONGS	16 x 14	8 3/4
BT264R	SEMI-S	4 PRONGS	16 x 20	8 3/4
BT266R	SEMI-S	6 PRONGS	16 x 30	8 3/4
BT272R	BLUNT	2 PRONGS	15.5 x 9	8 3/4
BT273R	BLUNT	3 PRONGS	15.5 x 14	8 3/4
BT274R	BLUNT	4 PRONGS	15.5 x 20	8 3/4
BT276R	BLUNT	6 PRONGS	15.5 x 30	8 3/4

KOERTE Retractor

Catalog Number	Tip	Blade End	Blade Size (mm)	Length (in.)
BT279R	SEMI-S	8 PRONGS	26 x 40	9 1/2
BT278R	BLUNT	8 PRONGS	26 x 40	9 1/2



BT278R-BT279R

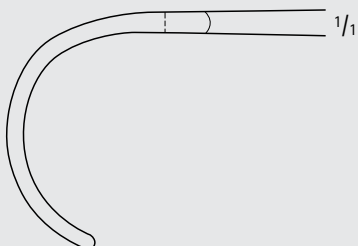

BT279R



BT278R



INCHES

General Surgery

Hand Held Retractors



ISRAEL Retractor

Catalog Number	Tip	Blade End	Blade Size (mm)	Length (in.)
BT284R	BLUNT	4 PRONGS	39 x 40	10
BT285R	BLUNT	5 PRONGS	47 x 51	10
BT286R	BLUNT	6 PRONGS	53 x 62	10
BT287R	BLUNT	6 PRONGS	70 x 70	10



BT284R-BT287R

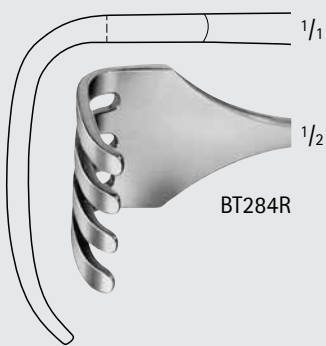

BT284R

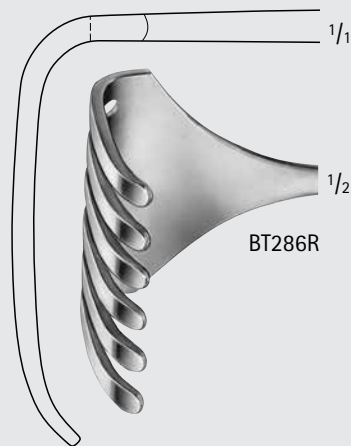

BT286R

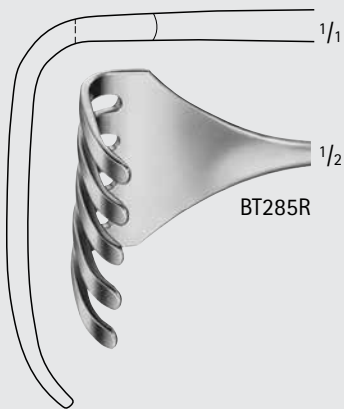

BT285R

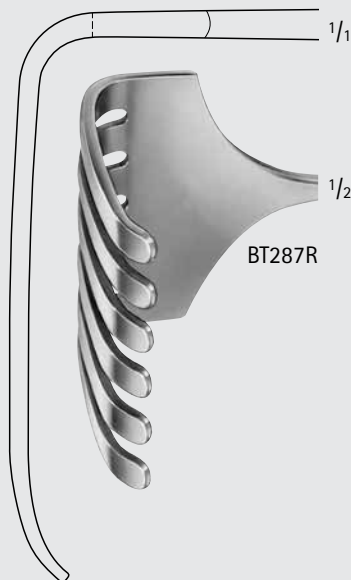

BT287R

ISRAEL Retractor, T-Handle

Catalog Number	Tip	Blade End	Blade Size (mm)	Length (in.)
MG284R	BLUNT	4 PRONGS	46 x 40	7 1/2



MG284R



MG284R

MURPHY Retractor

Catalog Number	Tip	Blade End	Length (in.)
BT293R	SHARP	3 PRONGS	7 3/4
BT294R	SHARP	4 PRONGS	7 3/4
BT296R	BLUNT	4 PRONGS	7 3/4



BT293R-BT296R



BT293R



BT296R



BT294R

KOERTE-WAGNER Retractor

Catalog Number	Tip	Blade End	Blade Size (mm)	Length (in.)
BT290R	SEMI-S	8 PRONGS	28 x 40	11

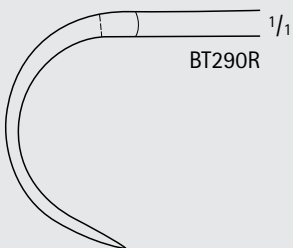

BT290R



BT290R



INCHES

General Surgery

Hand Held Retractors



LANGENBECK Retractor

Catalog Number	Blade Size (mm)	Length (in.)
BT311R	30 x 10	9
BT315R	40 x 10	9
BT316R	43 x 13	9

BT311R-BT316R

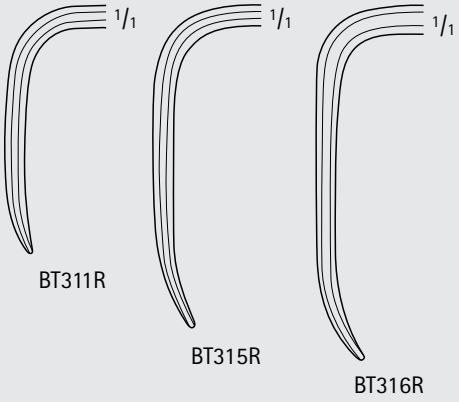

BT311R

BT315R

BT316R

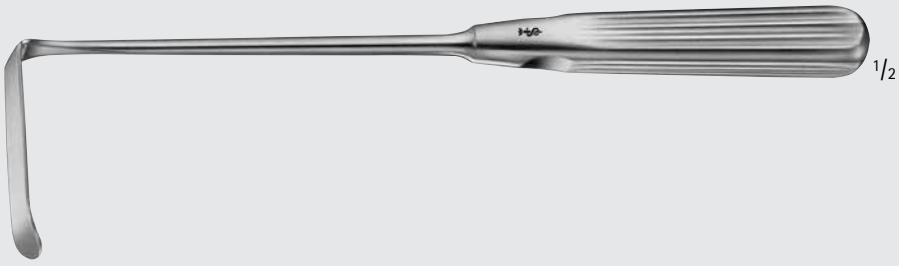

SAUERBRUCH Retractor

Catalog Number	Blade Size (mm)	Length (in.)
BT351R	46 x 16	8 7/8
BT352R	55 x 22	8 7/8
BT353R	72 x 19	8 7/8

BT351R-BT353R

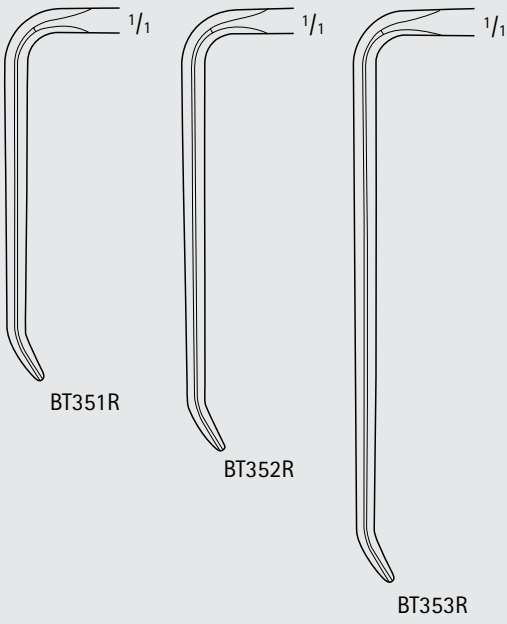

BT351R

BT352R

BT353R

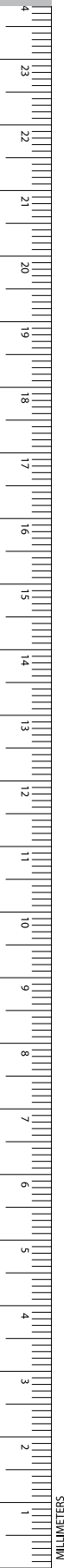



BT354R-BT365R

KOCHER-LANGENBECK Retractor

Catalog Number	Blade Size (mm)	Length (in.)
BT354R	25 x 6	8 1/2
BT356R	35 x 8	8 1/2
BT357R	35 x 11	8 1/2
BT358R	35 x 15	8 1/2
BT359R	41 x 11	8 1/2
BT361R	55 x 11	8 1/2
BT363R	70 x 14	8 1/2
BT364R	80 x 12	8 1/2
BT365R	80 x 16	8 1/2

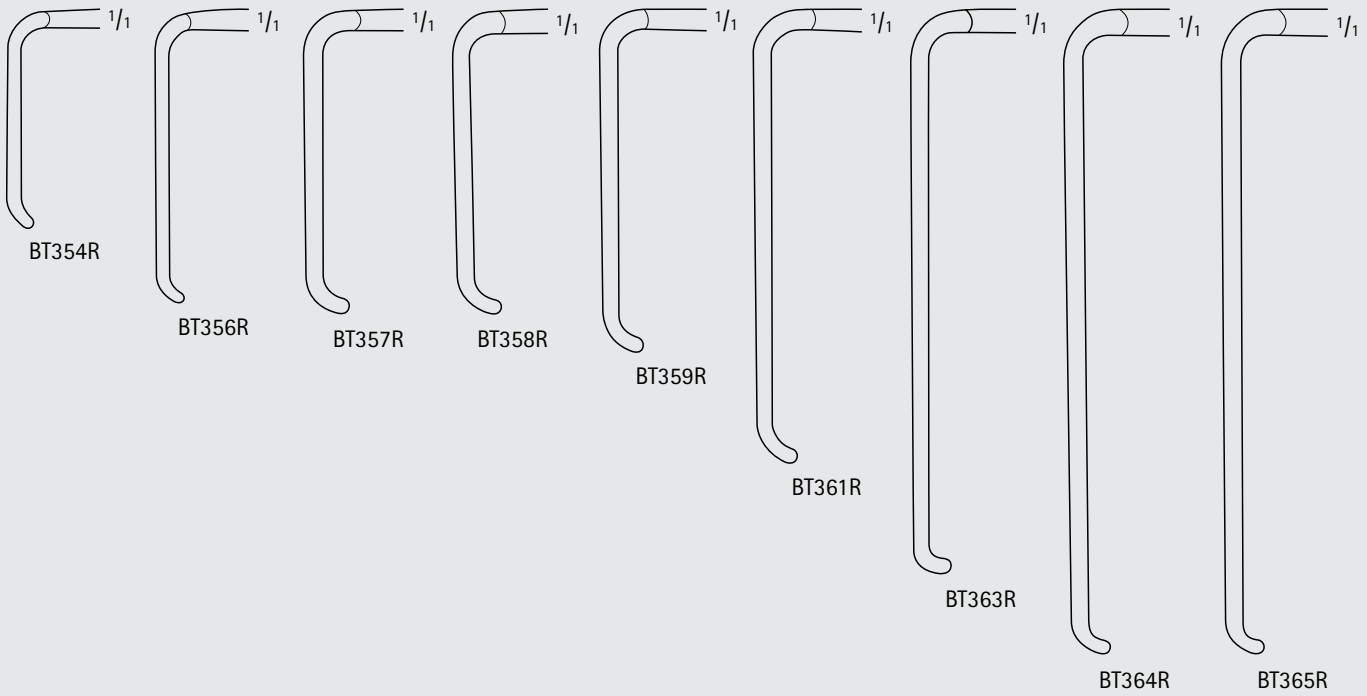

MB785R



MB785R

LAHEY Goiter Retractor

Catalog Number	Blade Size (mm)	Length (in.)
MB785R	24 x 8	7 7/8



INCHES

General Surgery

Hand Held Retractors



MB748R

MCBURNEY Thyroid Retractor

Catalog Number	Blade Size (mm)	Length (in.)
MB748R	20 x 10	7 1/2



MB748R



BT404R-BT406R

MIDDELDORPF Retractor

Catalog Number	Blade Size (mm)	Length (in.)
BT404R	15 x 15	8 3/4
BT405R	20 x 22	8 1/2
BT406R	28 x 28	9 1/4



BT404R

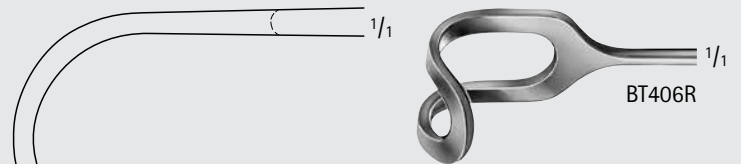

BT406R

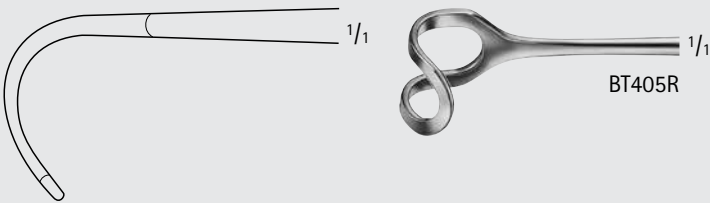

BT405R



BT408R

GREENE Retractor

Catalog Number	Blade Size (mm)	Length (in.)
BT408R	28 x 22	8 7/8

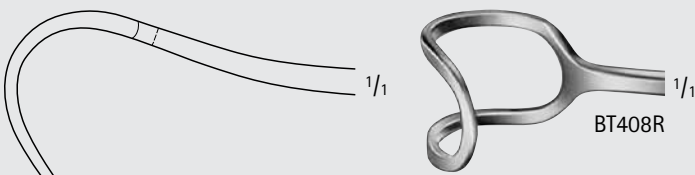

BT408R

General Surgery

Hand Held Retractors

GENERAL
SURGERY



DOCKHORN Cheek Retractor

Catalog Number	Blade Size (mm)	Length (in.)
D0438R	40 x 12	8 1/4
D0439R	55 x 14	8 1/4

D0438R-D0439R

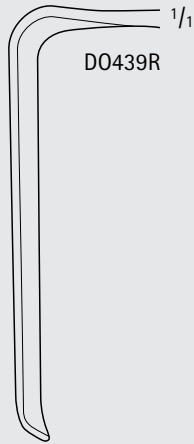

General Surgery
Abdominal Retractors

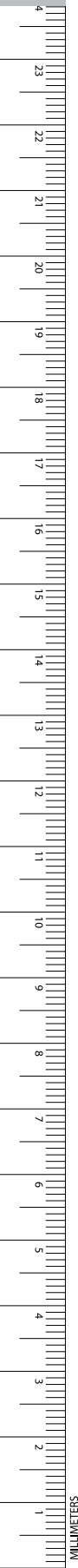

HOESEL Retractor

Catalog Number	Blade Size (mm)	Length (in.)
BT442R	100 x 30	9 3/4
BT446R	220 x 40	9 3/4

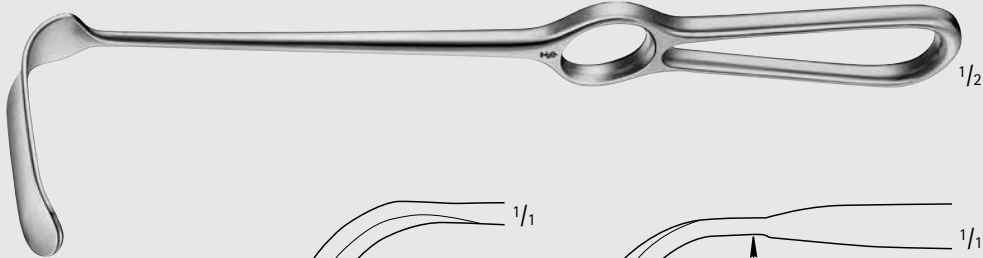

BT442R-BT446R



BT442R

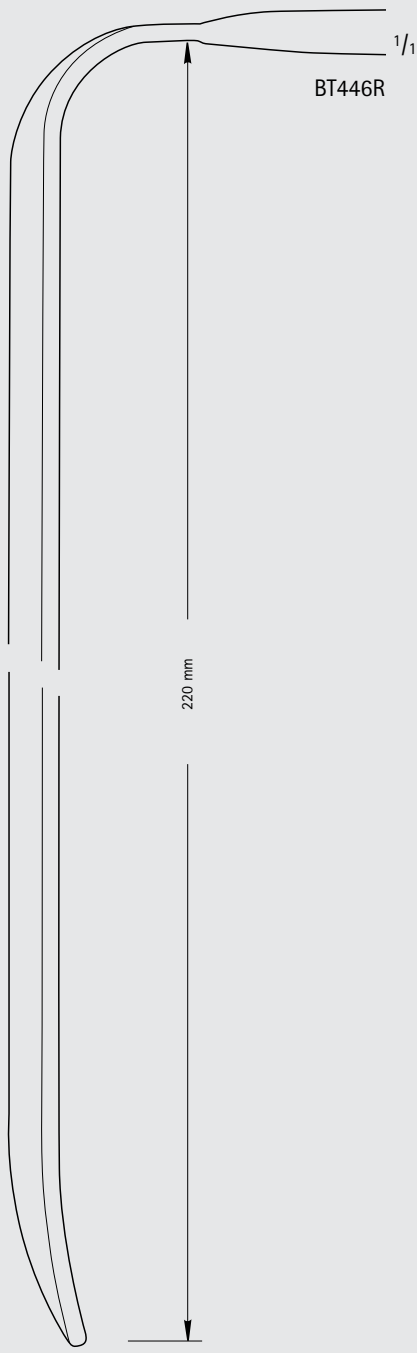

BT446R

220 mm

KOCHER Retractor

Catalog Number	Blade Size (mm)	Length (in.)
BT461R	80 x 42	9 3/4
BT462R	80 x 50	9 3/4
BT463R	80 x 60	9 3/4

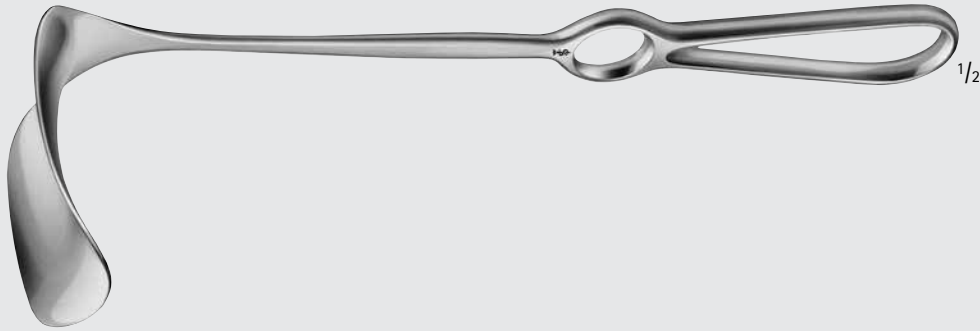

BT461R-BT463R

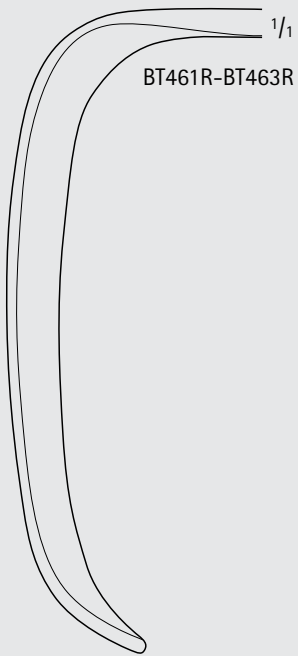

General Surgery

Abdominal Retractors



BT464R

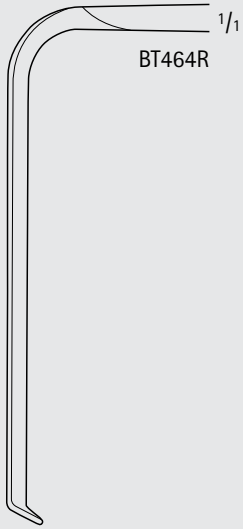

BT464R

KRAEMER Retractor

Catalog Number	Blade Size (mm)	Length (in.)
BT464R	66 x 10	8 1/4



BT465R



BT465R

CASPAR Retractor

Catalog Number	Blade Size (mm)	Length (in.)
BT465R	67 x 17	8 1/4



BT450R-BT469R

MIASPAS® Mini ALIF LANGENBECK Retractor

Catalog Number	Blade Size (mm)	Length (in.)
BT450R	125 x 20	8 1/4
BT451R	125 x 35	8 1/4
BT466R	80 x 20	8 1/4
BT467R	110 x 20	8 1/4
BT468R	80 x 35	8 1/4
BT469R	110 x 35	8 1/4

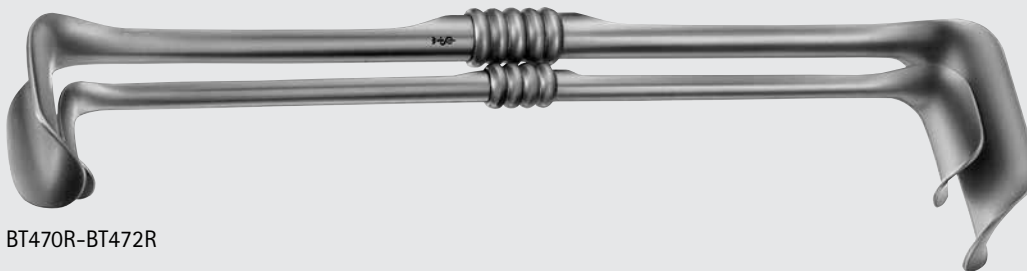

BT470R-BT472R

RICHARDSON-EASTMAN Retractor

Catalog Number	Description	Tip	Length (in.)
BT470R	2/SET (BT471R, BT472R)	-	-
BT471R	-	SM	9 3/4
BT472R	-	LRG	10 5/8

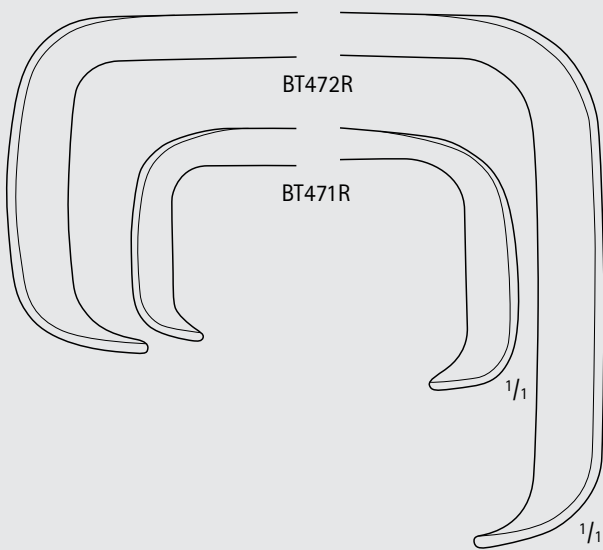

General Surgery

Abdominal Retractors



BT475R-BT477R

RICHARDSON Retractor

Catalog Number	Blade Size (mm)	Blade Size (in.)	Length (in.)
BT475R	23 x 20	1 x 3/4	9 1/2
BT476R	30 x 29	1 1/4 x 1 1/8	9 1/2
BT477R	37 x 37	1 1/2 x 1 1/2	9 1/2
BT478R	47 x 21	2 x 3/4	9 1/2

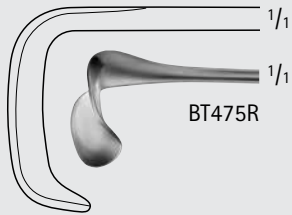

BT475R

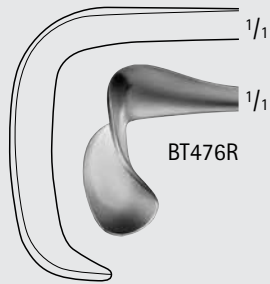

BT476R

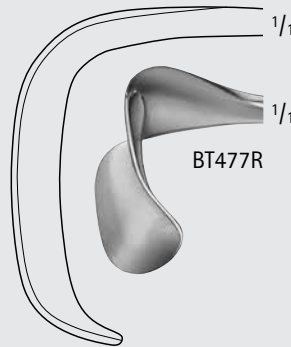

BT477R



BT478R

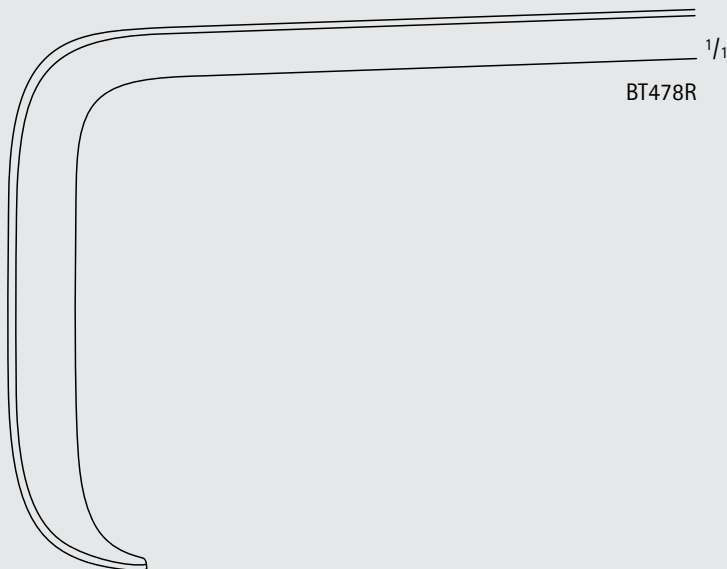

BT478R

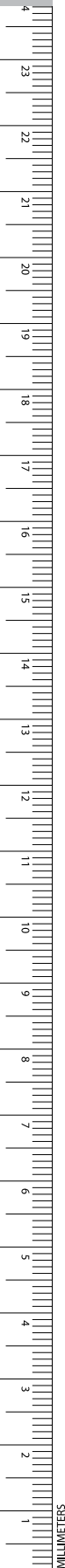

General Surgery

Abdominal Retractors

RICHARDSON Retractor

Catalog Number	Blade Size (mm)	Blade Size (in.)	Length (in.)
BT479R	65 x 41	2 1/2 x 1 5/8	9 3/4

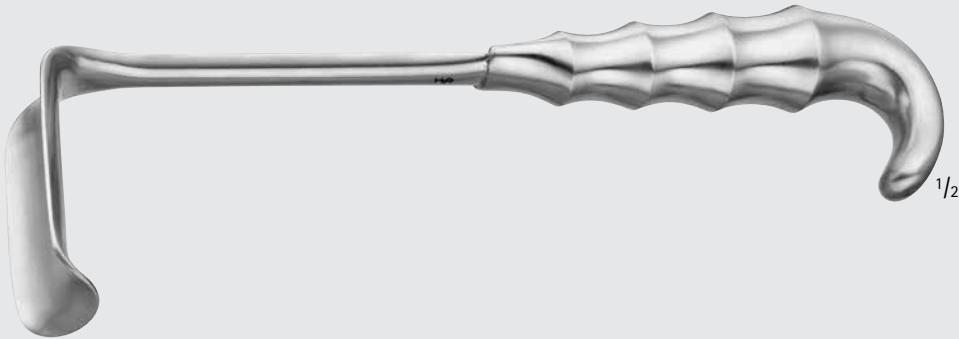

BT479R

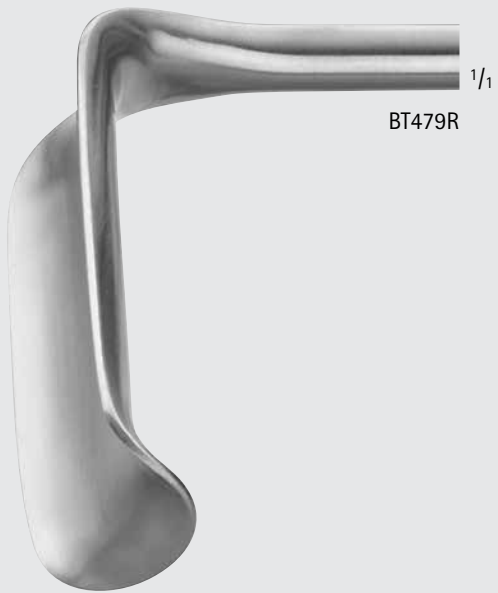

BT479R



INCHES

General Surgery
Abdominal Retractors

KELLY Retractor

Catalog Number	Blade Size (mm)	Blade Size (in.)	Length (in.)
BT481R	50 x 40	2 x 1 1/2	10 1/4
BT482R	64 x 54	2 1/2 x 2	10 1/4
BT483R	70 x 65	2 3/4 x 2 1/2	10 1/4
BT484R	90 x 76	3 1/2 x 3	10 1/4

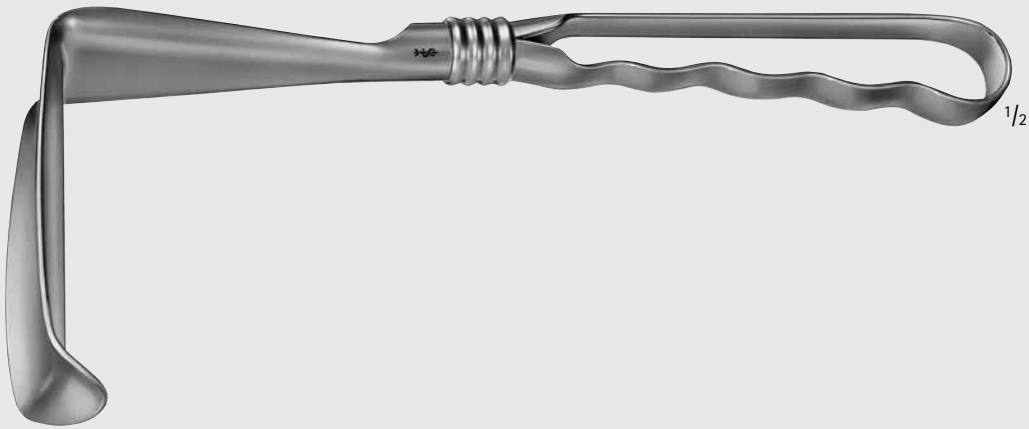

BT481R-BT484R



BT481R

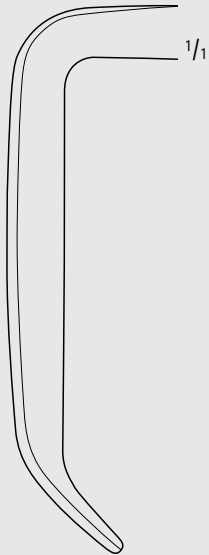

BT482R

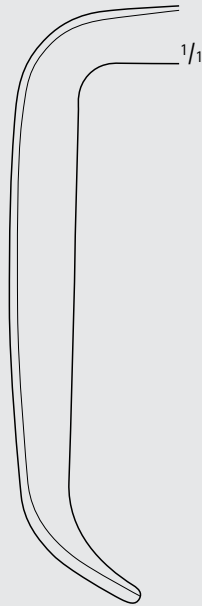

BT483R

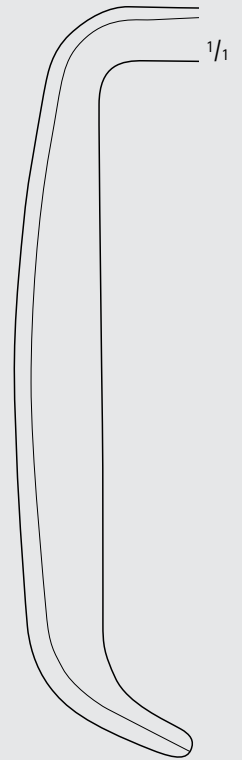

BT484R

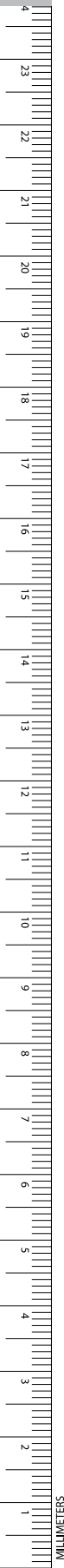

General Surgery

Abdominal Retractors

SAUERBRUCH Retractor, Open

Catalog Number	Blade Size (mm)	Length (in.)
BT514R	130 x 38	10 1/4

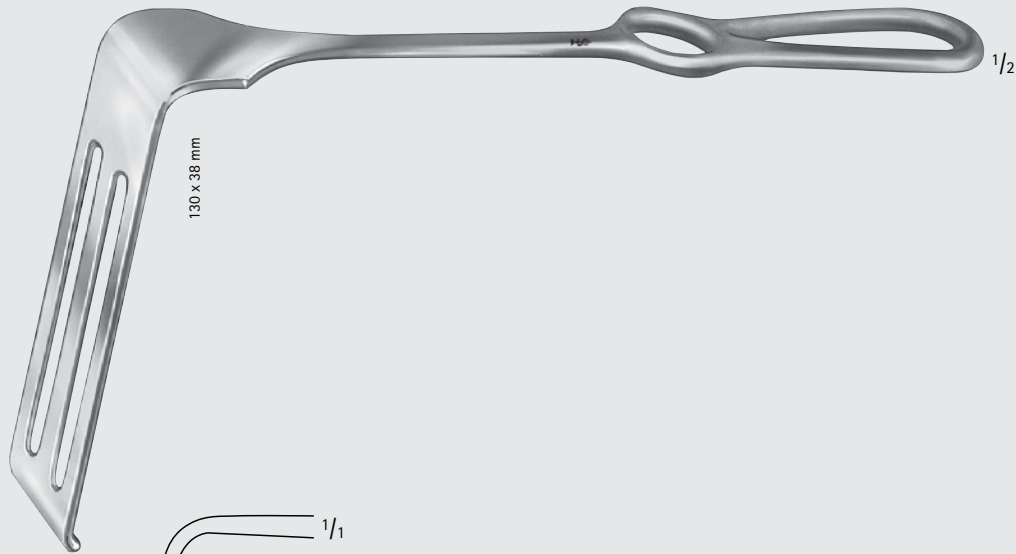

BT514R



BT514R



INCHES

General Surgery
Abdominal Retractors

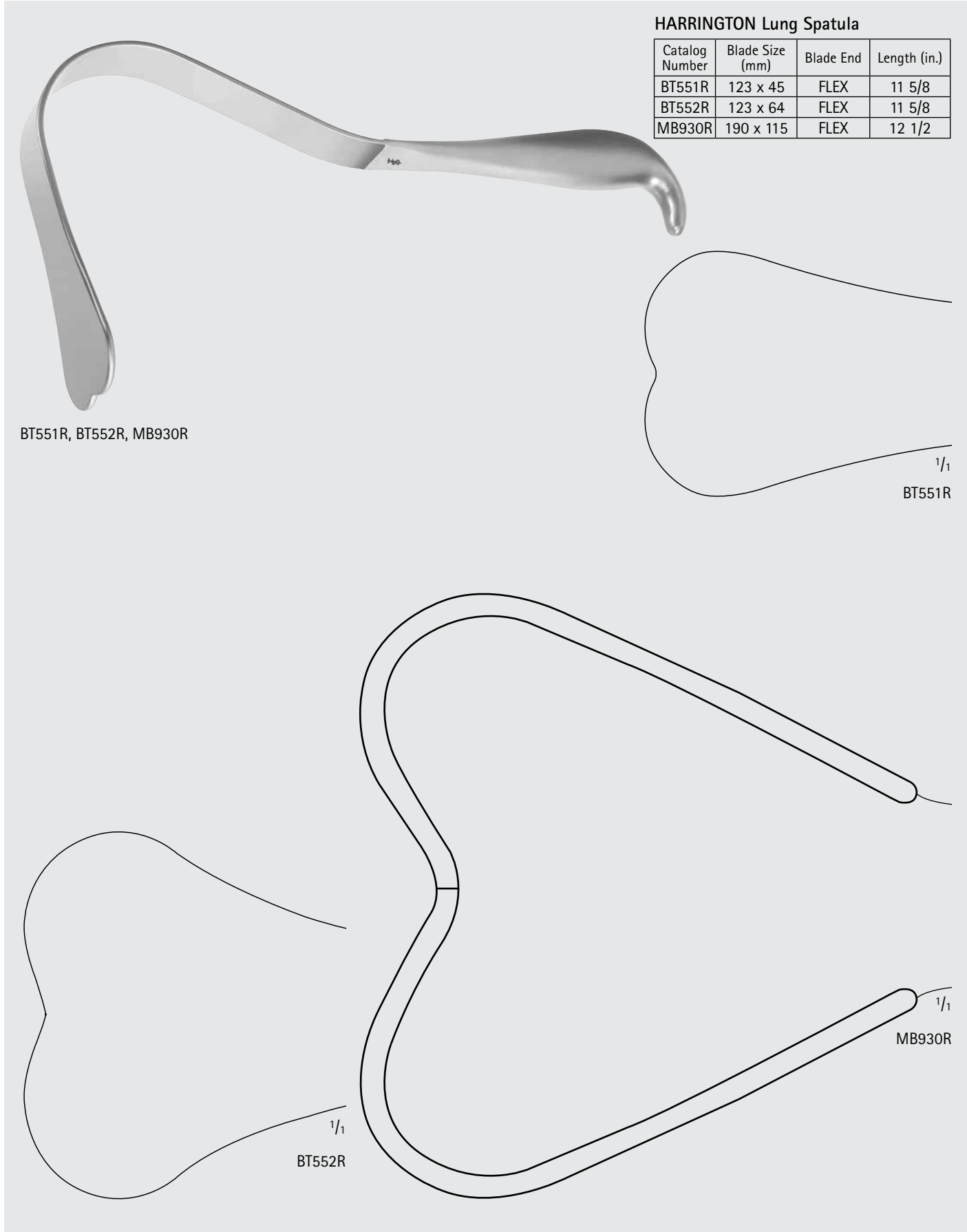
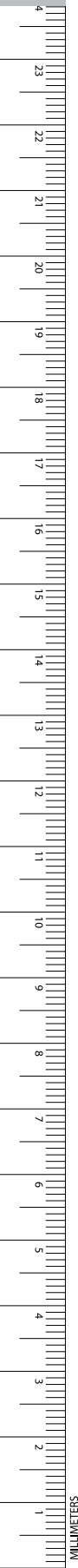

HARRINGTON Lung Spatula

Catalog Number	Blade Size (mm)	Blade End	Length (in.)
BT551R	123 x 45	FLEX	11 5/8
BT552R	123 x 64	FLEX	11 5/8
MB930R	190 x 115	FLEX	12 1/2

BT551R, BT552R, MB930R

BT551R

BT552R

MB930R

General Surgery

Abdominal Retractors

GENERAL
SURGERY

HARRINGTON Retractor, Large Blade

Catalog Number	Blade Size (mm)	Blade End	Length (in.)
MG472R	195 x 115	FLEX	14 3/8



MG472R

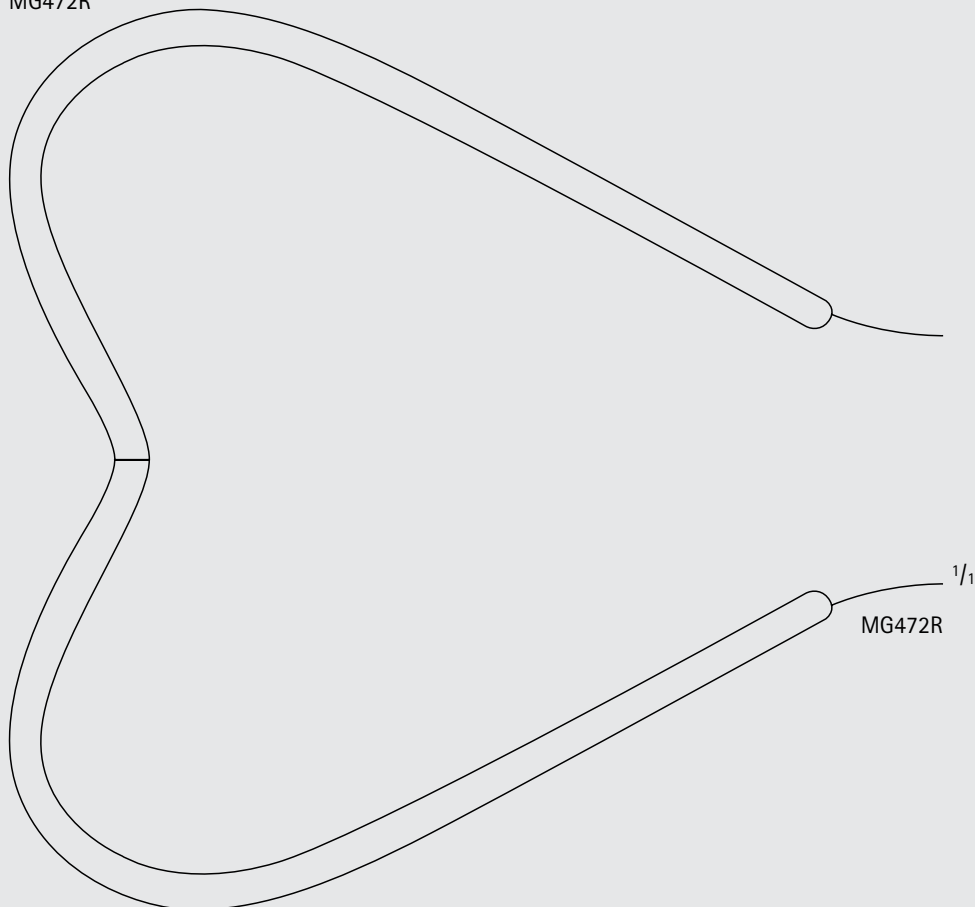

MG472R



INCHES

General Surgery
Abdominal Retractors

HARRINGTON-PEMBERTON Lung
Spatula

Catalog Number	Blade Size (mm)	Blade End	Length (in.)
BT553R	175 x 64	FLEX	11 5/8

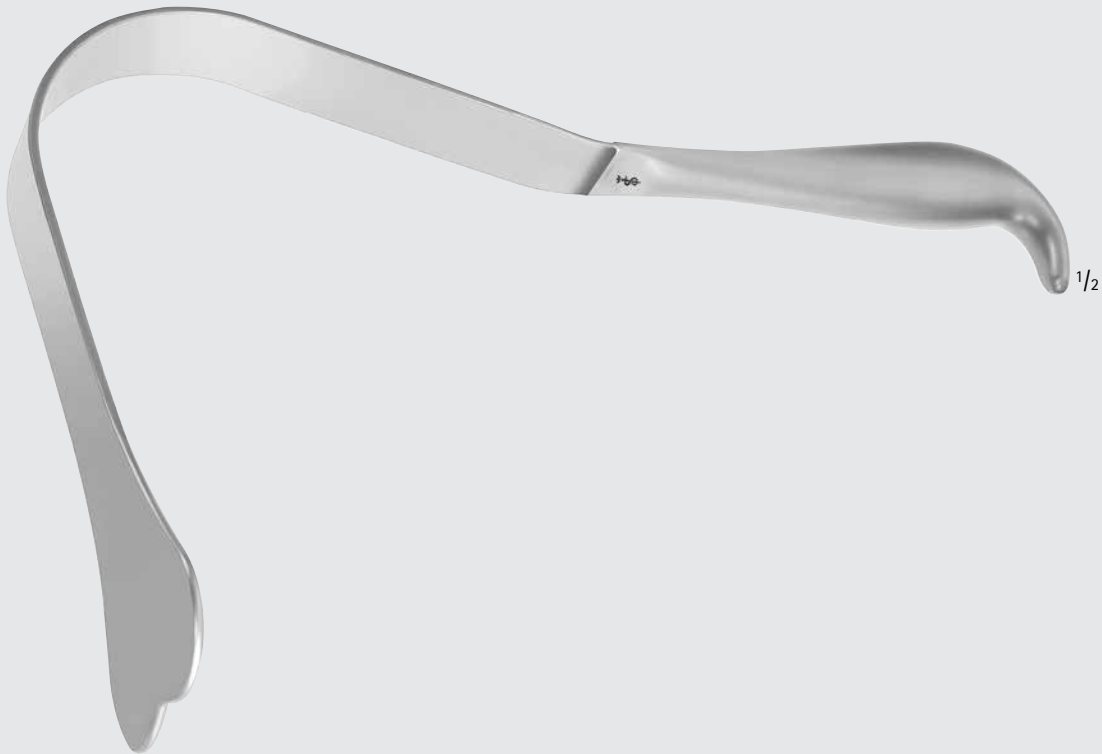

BT553R

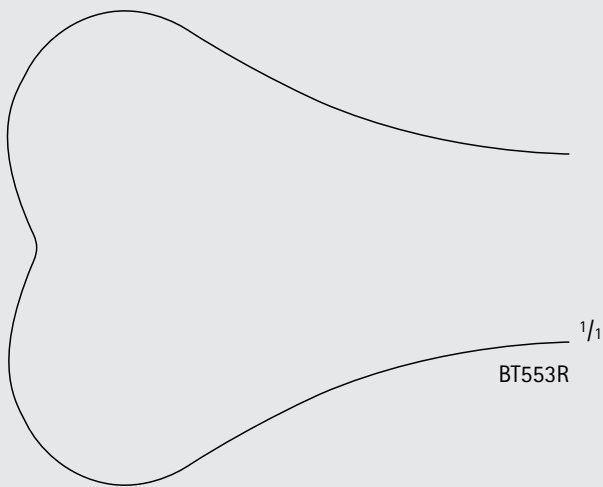

BT553R

1/i

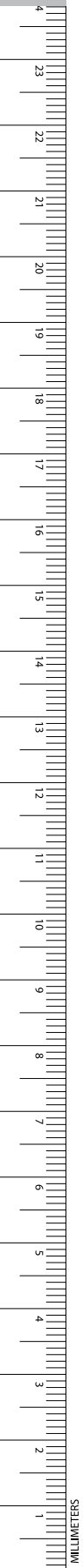

ZENKER Retractor

Catalog Number	Blade Size (mm)	Length (in.)
BT594R	36 x 8	9 1/2
BT595R	60 x 12	10
BT596R	75 x 12	10 5/8
BT597R	120 x 12	11 1/2



BT594R-BT597R

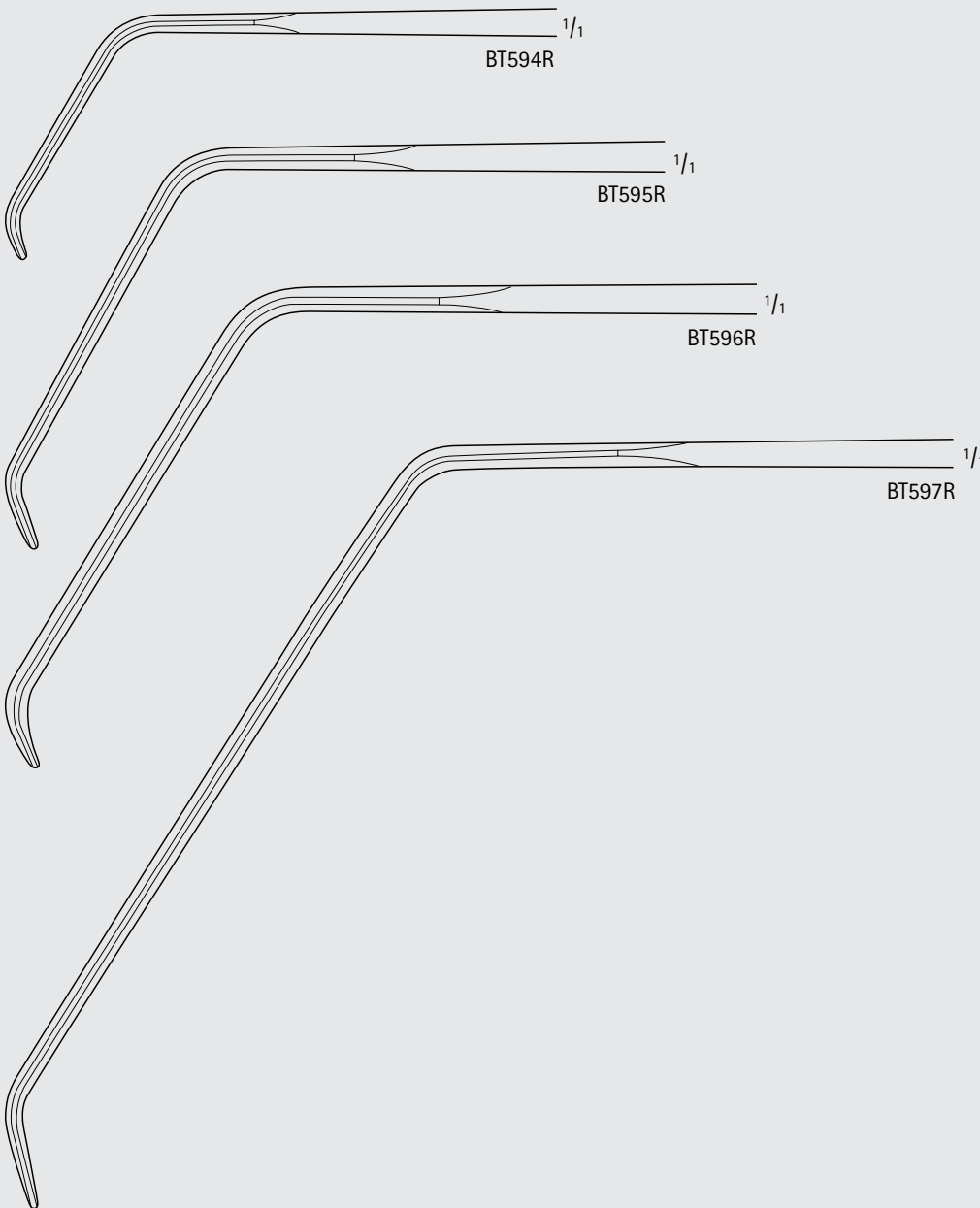

INCHES

General Surgery

Abdominal Retractors

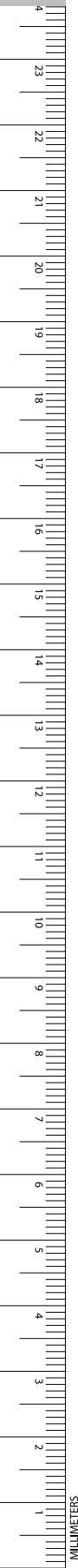

BT600R



BT600R

DEAVER Retractor

Catalog Number	Blade Size (mm)	Blade Size (in.)	Length (in.)
BT600R	19	3/4	7

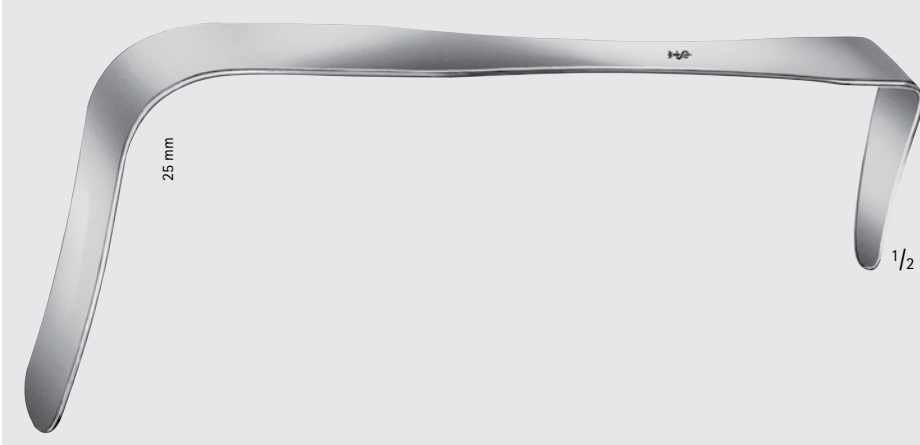

BT606R



BT606R

DEAVER Retractor, Double Ended

Catalog Number	Blade Size (mm)	Blade Size (in.)	Length (in.)
BT606R	25	1	9 1/4

DEAVER Retractor

Catalog Number	Blade Size (mm)	Blade Size (in.)	Length (in.)
BT601R	22	7/8	8 1/2
BT602R	25	1	11 3/4
BT603R	25	1	12 3/8



BT601R



BT601R



BT602R-BT603R

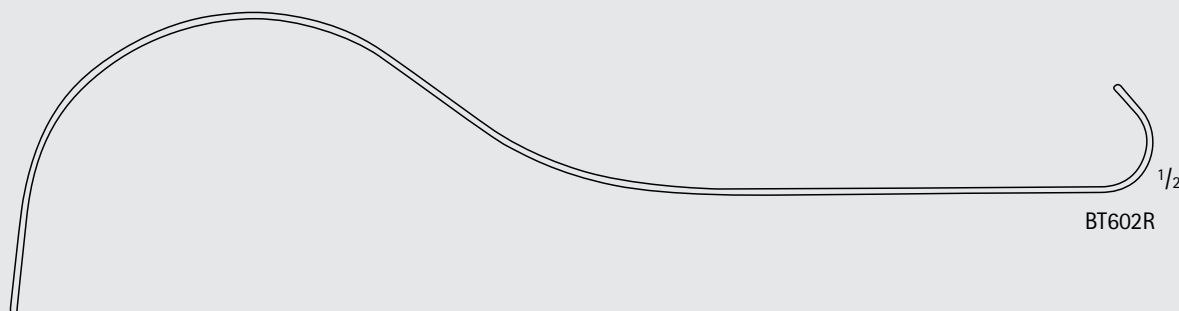

BT602R

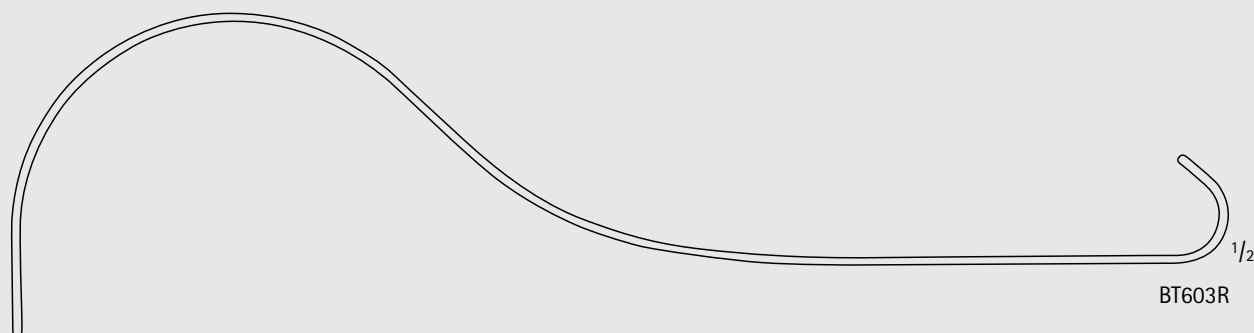

BT603R



INCHES

General Surgery

Abdominal Retractors



**DEAVER Retractor
(continued)**

Catalog Number	Blade Size (mm)	Blade Size (in.)	Length (in.)
BT604R	38	1 1/2	11 3/4



BT604R

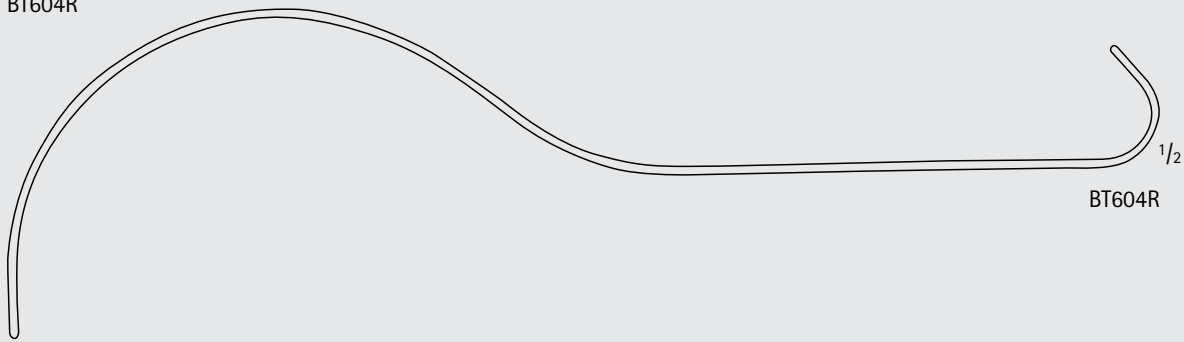

BT604R

DEAVER Retractor
(continued)

Catalog Number	Blade Size (mm)	Blade Size (in.)	Length (in.)
BT605R	50	2	12 1/4
BT607R	25	1	14 3/8



BT605R-BT607R

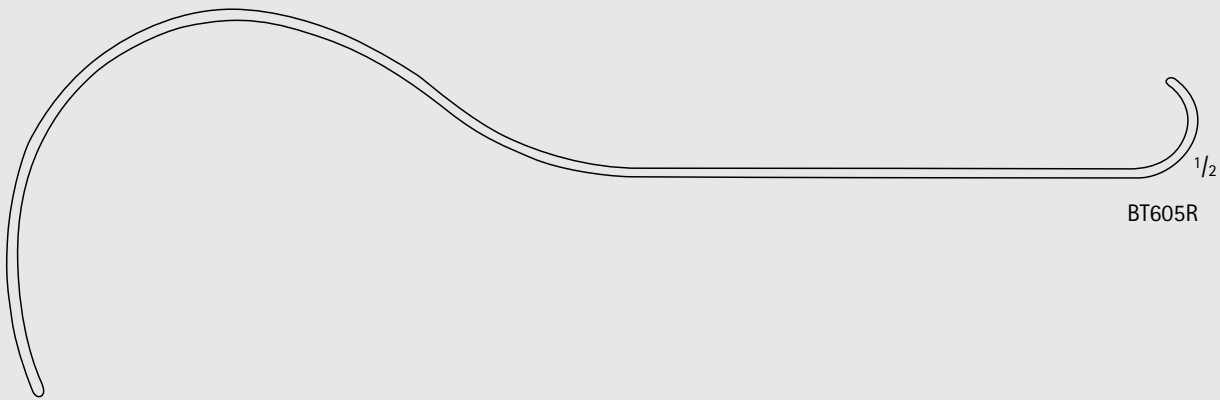

BT605R

1/2

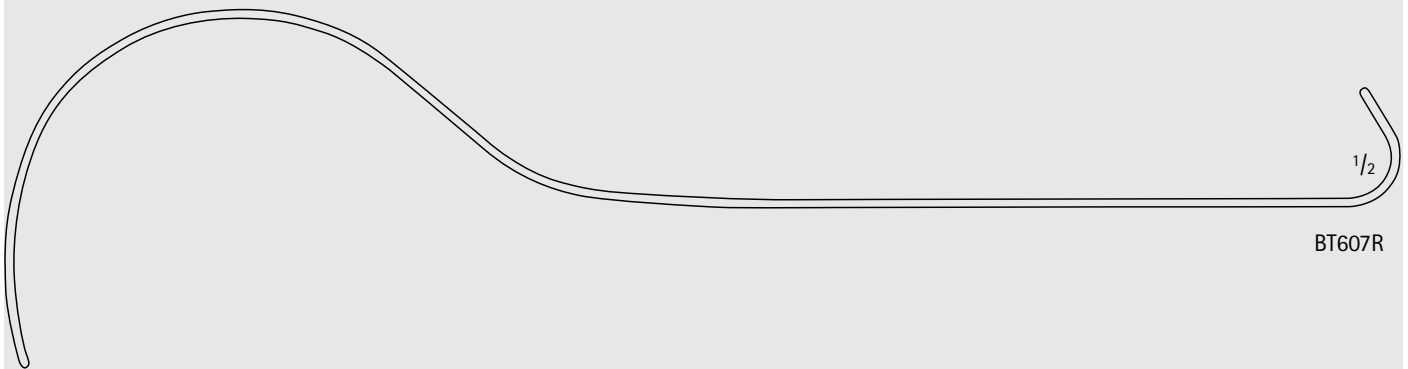

BT607R

1/2



INCHES

General Surgery

Abdominal Retractors

DEAVER Retractor
(continued)

Catalog Number	Blade Size (mm)	Blade Size (in.)	Length (in.)
BT608R	75	3	12 1/2

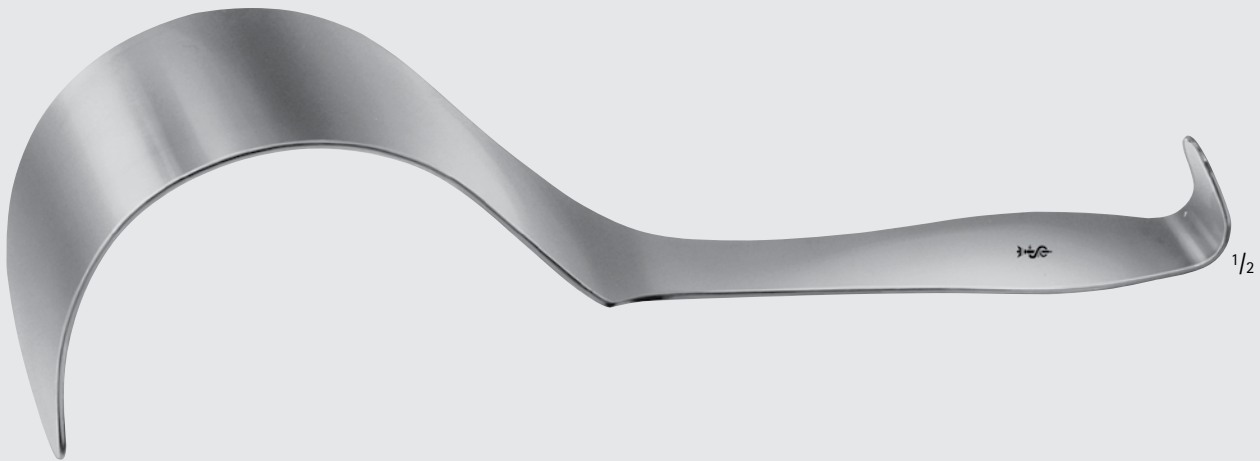

BT608R

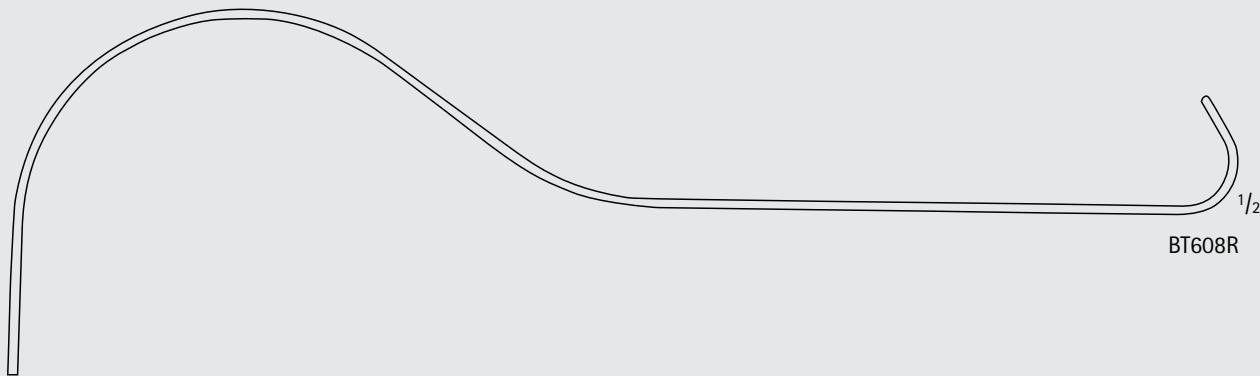

BT608R



DEAVER Retractor, W/ Grip

Catalog Number	Blade Size (mm)	Blade Size (in.)	Length (in.)
BT611R	25	1	12 1/4
BT613R	38	1 1/2	12 1/4
BT614R	50	2	12
BT615R	75	3	12 1/4



BT611R-BT615R

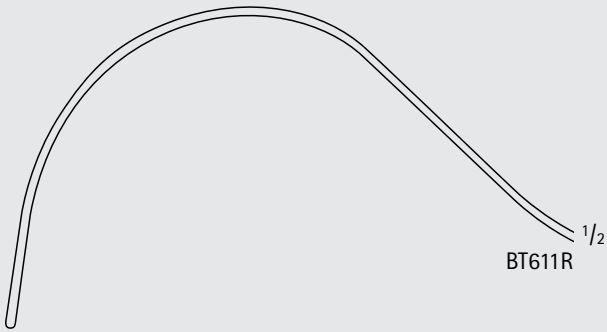

BT611R

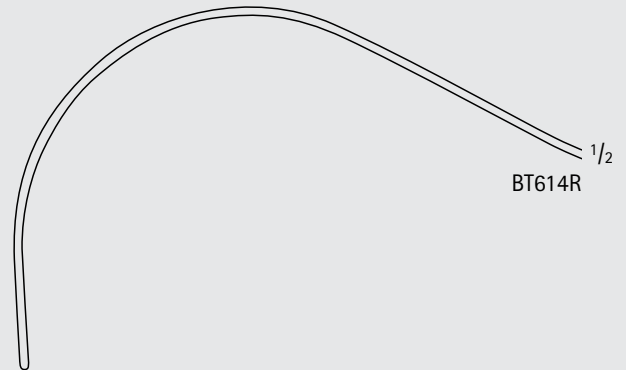

BT614R

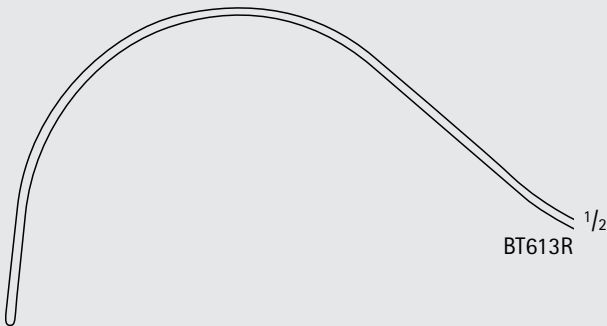

BT613R

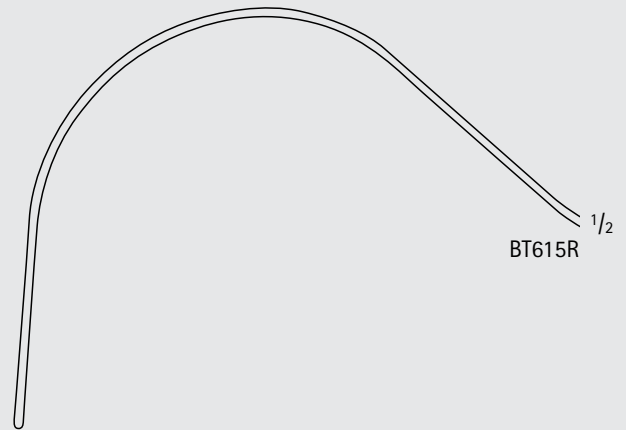

BT615R



General Surgery
Abdominal Retractors

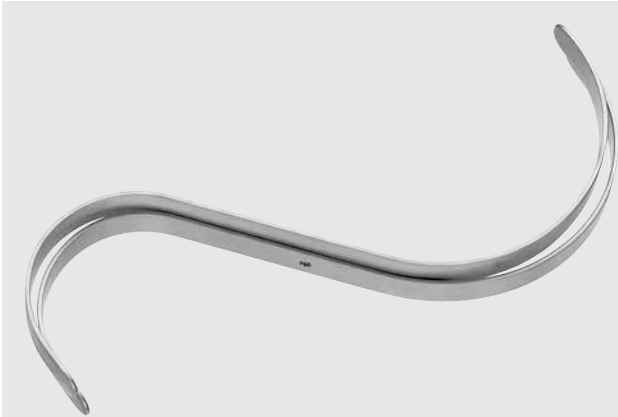

MD071R-MD076

HASSON "S" Retractor, 2/Set

Catalog Number	Blade	Blade Size (mm)	Length (in.)
MD076	MALLEABLE	10	6 1/4
MD077	MALLEABLE	13	7
MD071R	RIGID	10	7 1/8
MD072R	RIGID	13	7 1/8

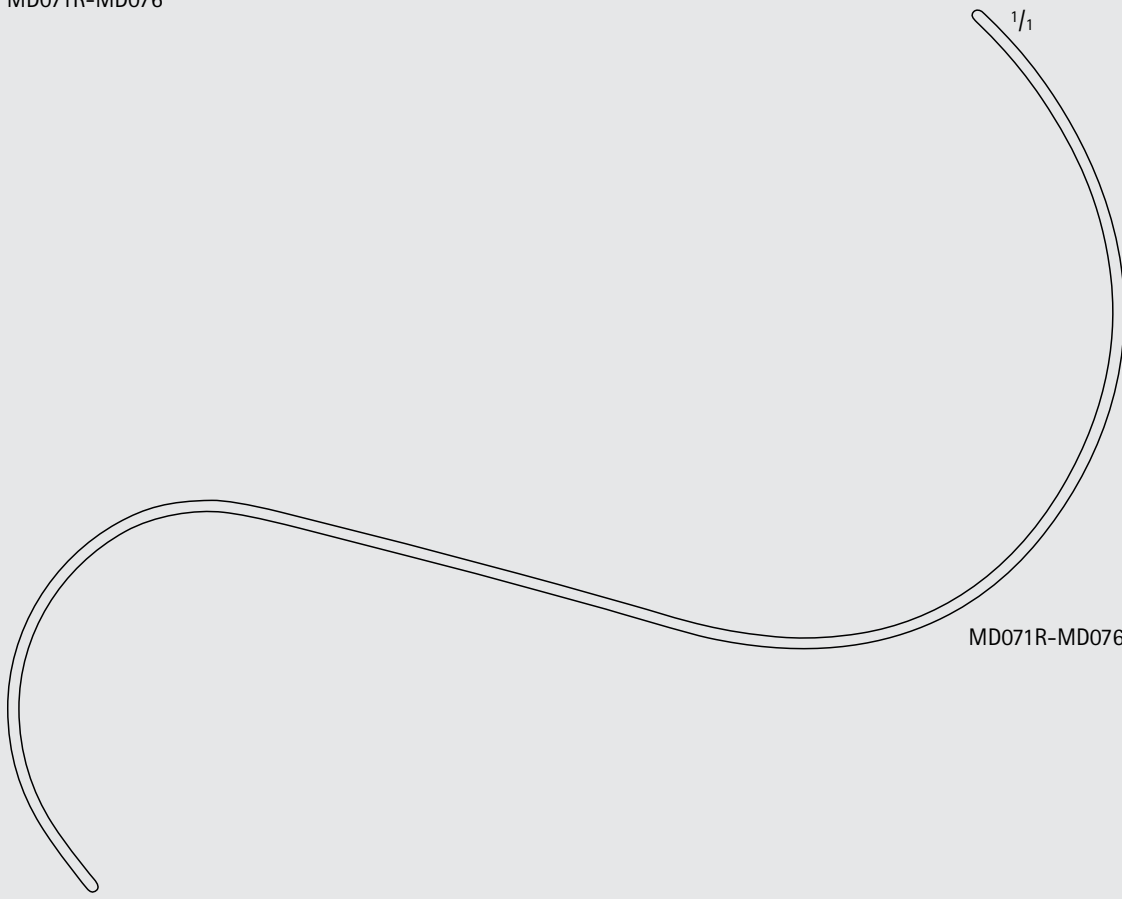

MD071R-MD076



BT750R

TUFFIER Spatula, Malleable

Catalog Number	Blade Size (mm)	Blade Size (in.)	Length (in.)
BT750R	17 / 25	3/4 / 1	7 7/8



BT751R-BT763R, MD498, MG480R-MG484R

Ribbon Spatula, Malleable

Catalog Number	Blade Size (mm)	Blade Size (in.)	Length (in.)
MG480R	5	1/8	8
BT751R	12	1/2	7 7/8
BT752R	17	3/4	7 7/8
MG481R	25	1	8
BT755R	25	1	9 3/4
MD498	75	3	13
MG482R	20	3/4	13
BT756R	25	1	13
BT761R	30	1 1/4	13
BT762R	40	1 1/2	13
BT763R	50	2	13
MG483R	65	2 1/2	13
MG484R	100	4	13



BT758R

HABERER Spatula, Malleable

Catalog Number	Blade Size (mm)	Blade Size (in.)	Length (in.)
BT758R	40 / 50	1 1/2 / 2	12



MG374R



MG374R

Spatula and Packer, Double Ended

Catalog Number	Length (in.)
MG374R	5 3/4



INCHES

General Surgery

Abdominal Retractors

DOYEN Abdominal Retractor

Catalog Number	Blade Size (mm)	Length (in.)
BT667R	53 x 80	9 3/4
BT669R	72 x 82	10 1/4



BT667R



BT669R

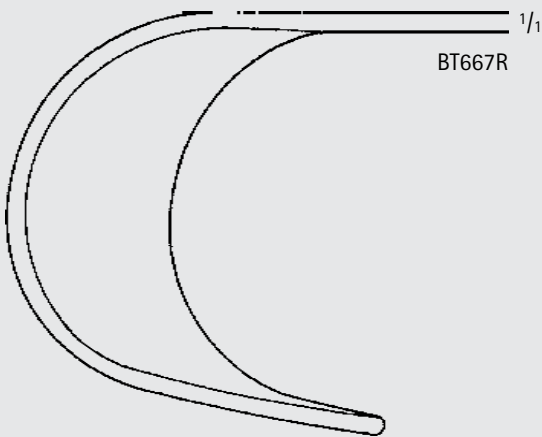

BT667R

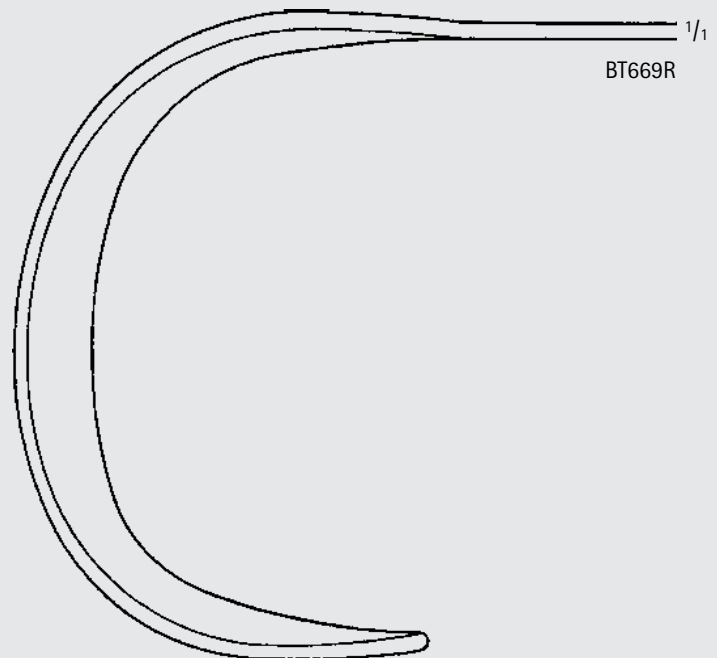

BT669R

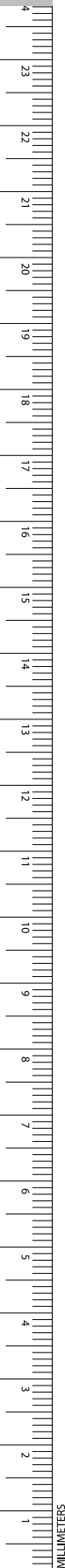

General Surgery

Abdominal Retractors

GENERAL
SURGERY

WEINBERG Vagotomy Retractor, Joe's Hoe

Catalog Number	Blade Size (mm)	Length (in.)
MG491R	47 x 57 / 93 x 157	9



MG491R



INCHES

General Surgery
Abdominal Retractors

ST. MARKS Pelvis Retractor

Catalog Number	Blade Size (mm)	Length (in.)
BT670R	124 x 60	11 1/2
BT672R	174 x 60	13

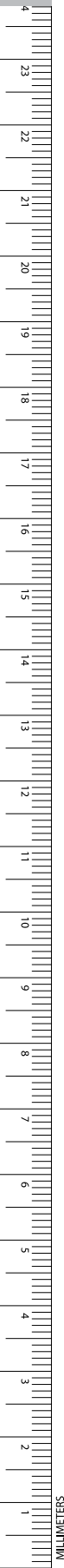
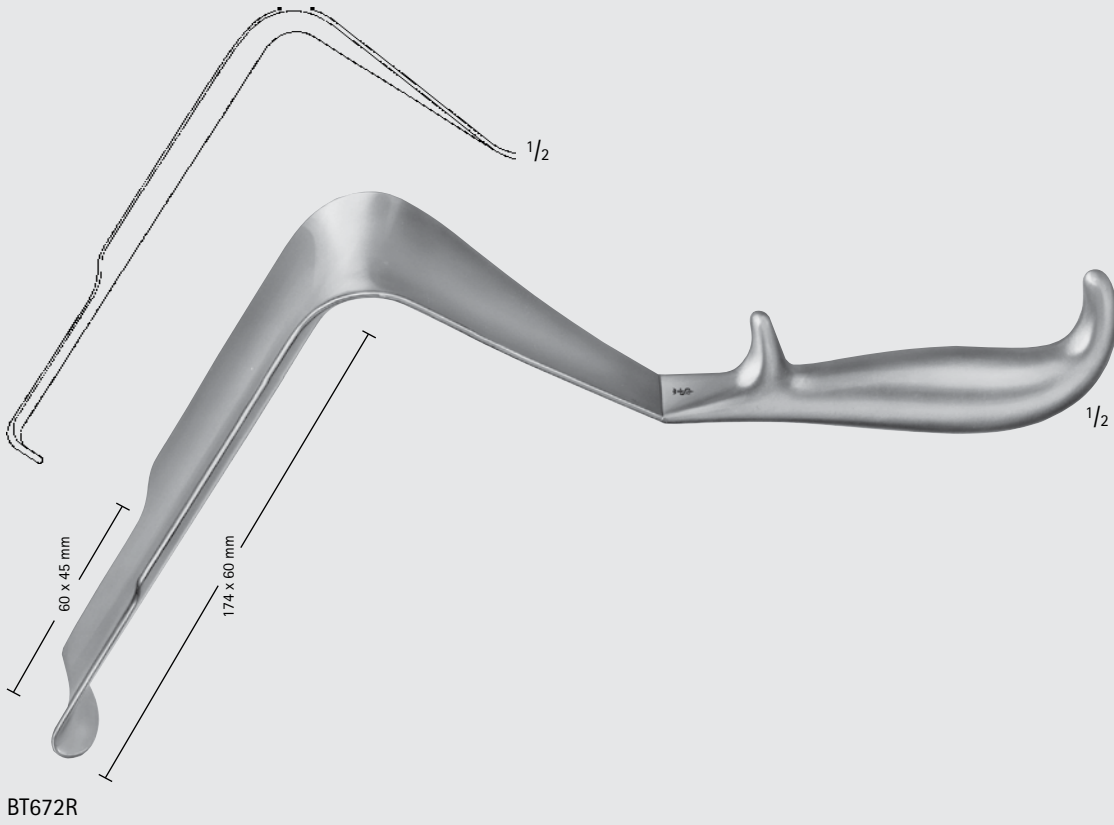
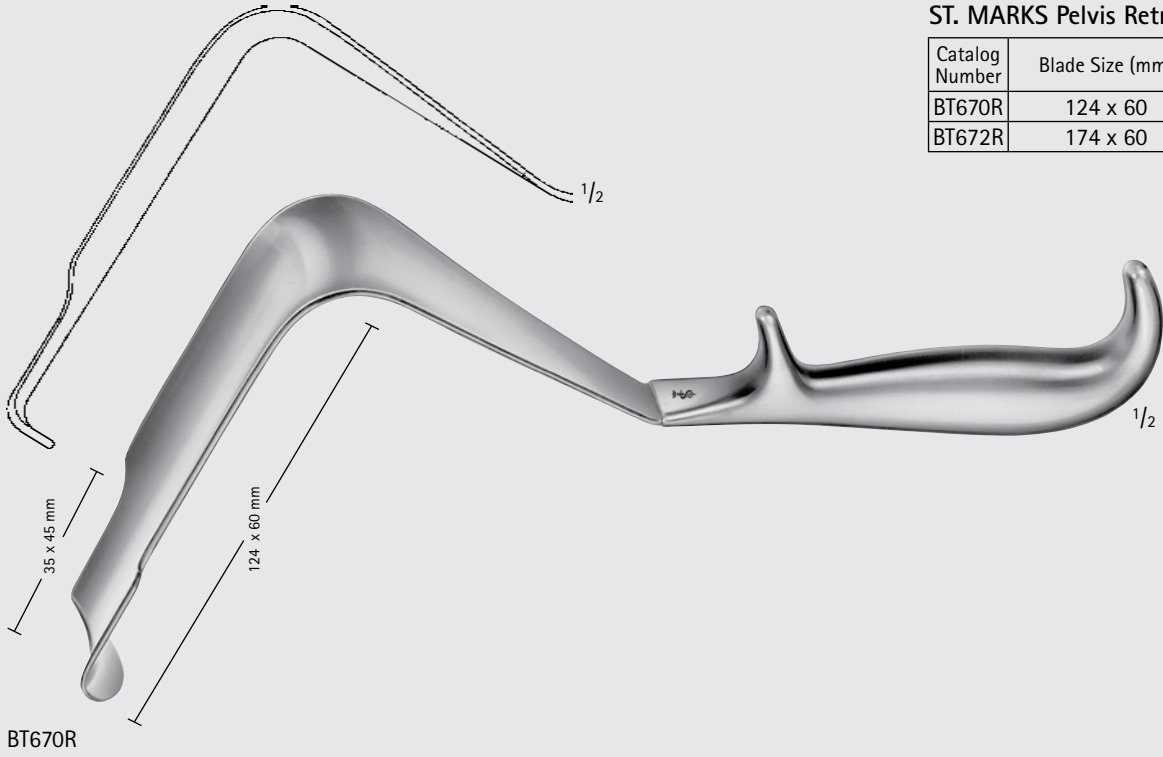

ST. MARKS Pelvis Retractor
(continued)

Catalog Number	Blade Size (mm)	Length (in.)
BT674R	178 x 60	13

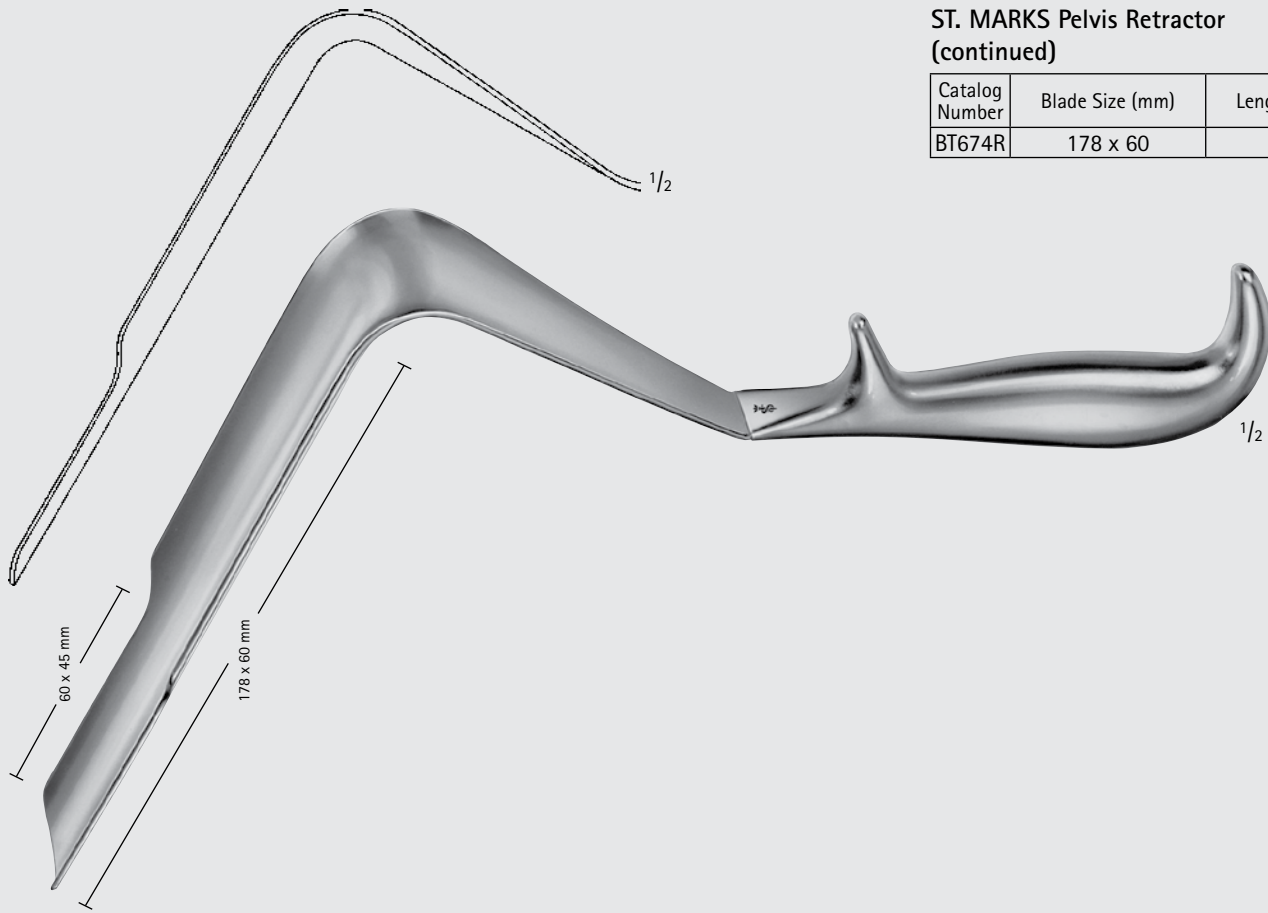

BT674R



INCHES

General Surgery
Abdominal Retractors

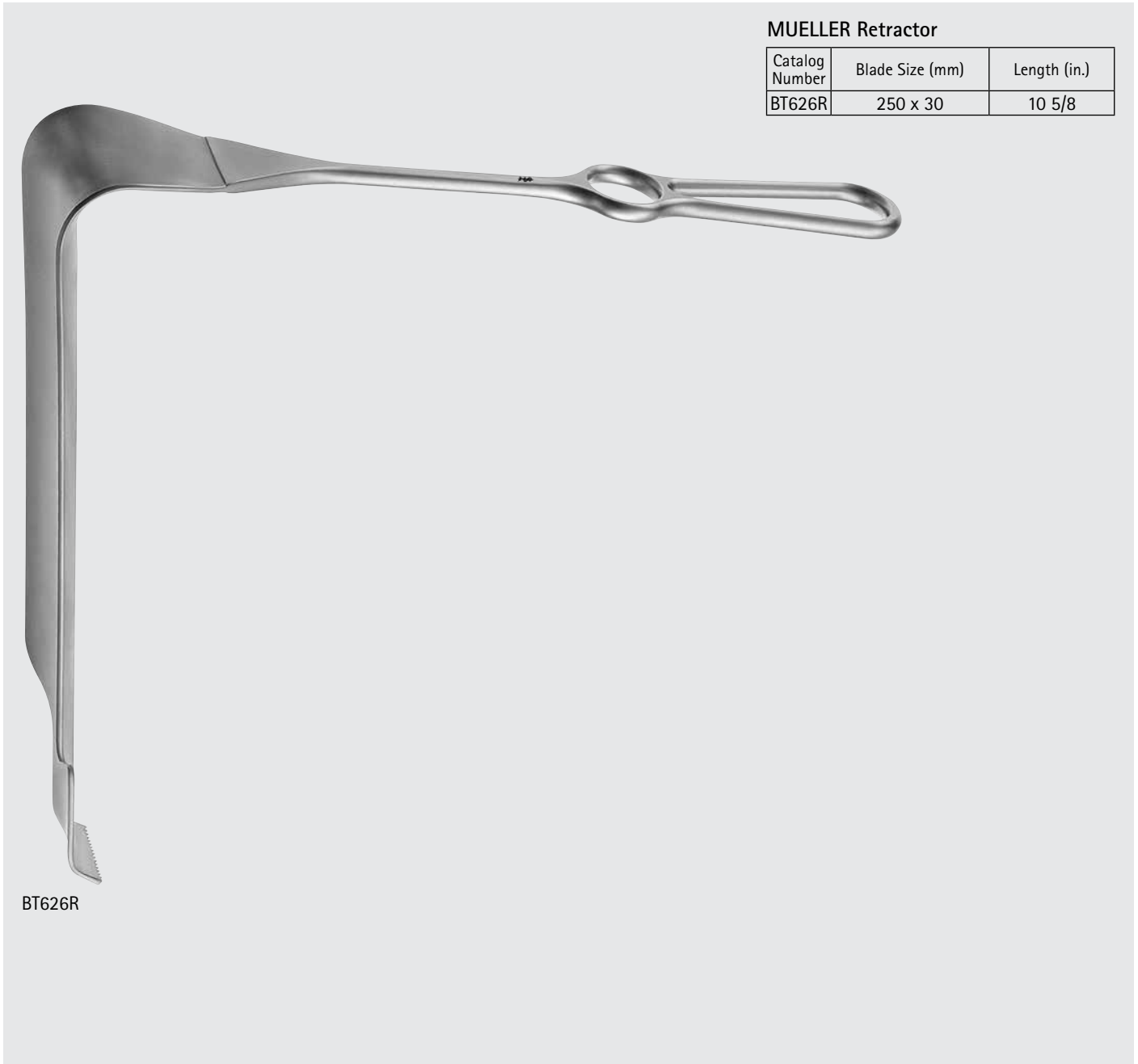
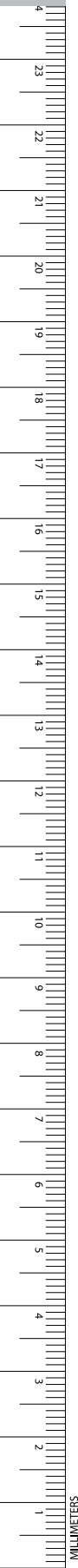

MUELLER Retractor

Catalog Number	Blade Size (mm)	Length (in.)
BT626R	250 x 30	10 5/8

BT626R



MAYO-COLLINS Appendectomy Retractor

Catalog Number	Length (in.)
MB129R	6 3/4

MB129R

1/2

General Surgery

Abdominal Retractors

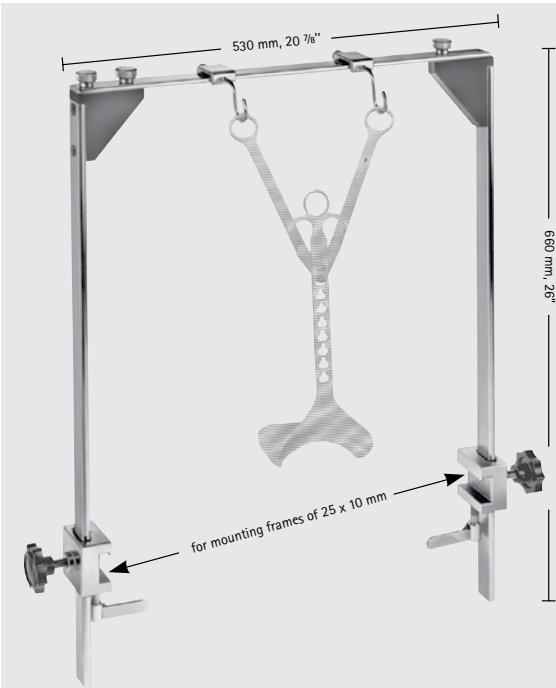

ROCHARD Retractor Mounting Frame, F/ BT711R-BT715R

Catalog Number	Mounting Arms
BT708R	DOUBLE
BT709R	SINGLE

Mounting frame for fastening to the lateral bars of the operating tables, can be dismantled for decontamination and sterilization.

BT708R-BT709R

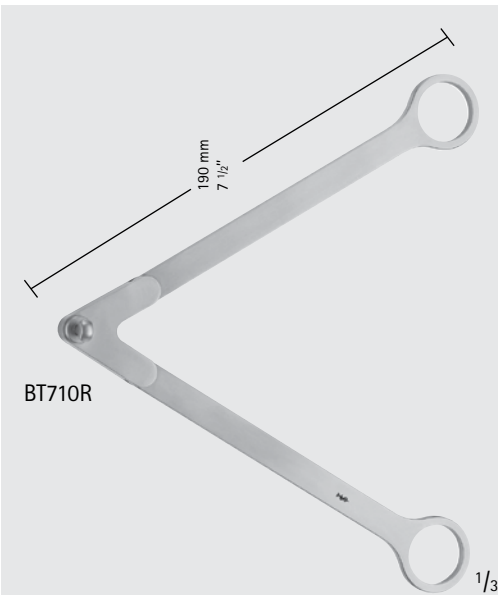

ROCHARD Fixation Device, F/ BT711R-BT715R

Catalog Number	Length (mm)	Length (in.)
BT710R	190	7 1/2

BT710R

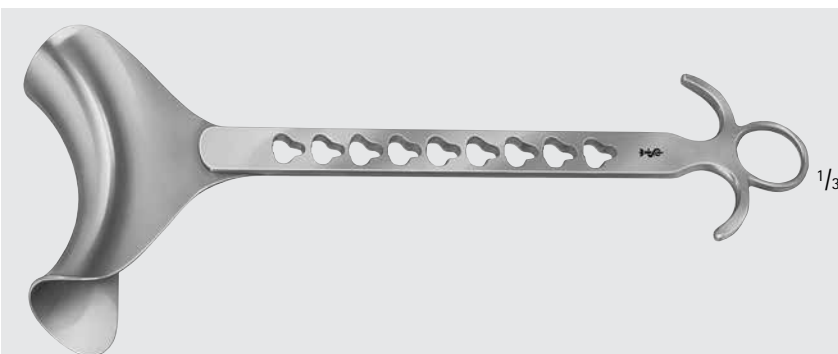

ROCHARD Blades

Catalog Number	Blade Size (mm)	Length (in.)
BT711R	48 x 90	12 1/4
BT712R	48 x 105	12 1/4
BT713R	48 x 120	12 1/4
BT714R	48 x 135	12 1/4
BT715R	48 x 155	12 1/4

BT711R-BT715R



General Surgery
Abdominal Retractors

Abdominal Retractor, Malleable,
W/ Handle

Catalog Number	Blade Size (mm)	Blade Size (in.)	Length (in.)
BT773R	30	1 1/4	16 1/8
BT774R	40	1 1/2	16 1/8
BT775R	50	2	16 1/8
BT776R	60	2 1/2	16 1/8
BT777R	70	2 3/4	16 1/8

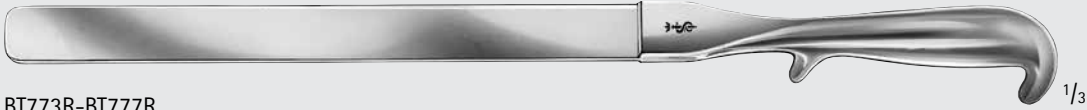

BT773R-BT777R ^{1/3}

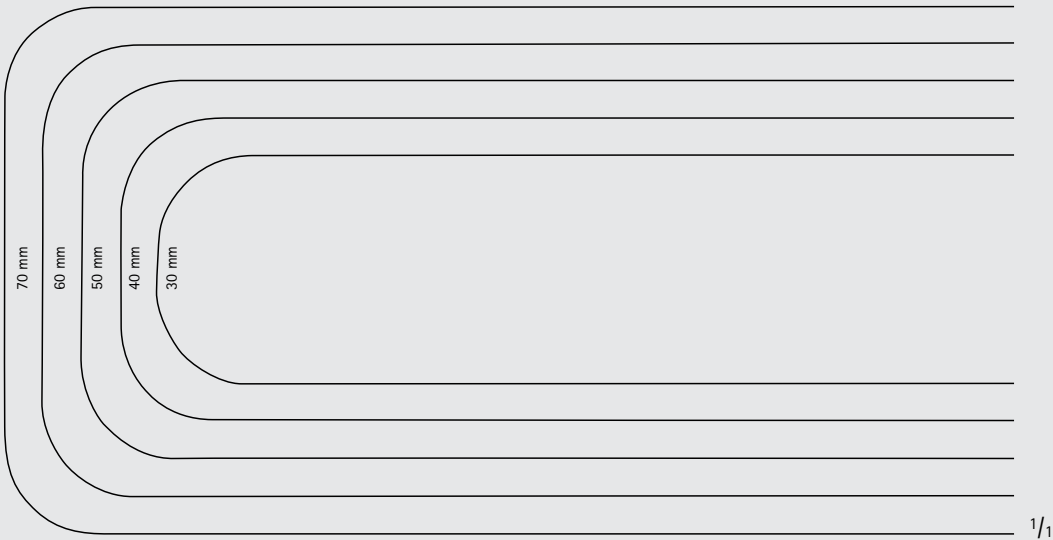

BT773R-BT777R ^{1/1}



MB226, MG582R-MG586R

Laparotomy Ring

Catalog Number	Diameter (in.)
MG582R	1 1/2
MG585R	1 3/4
MB226	2
MG586R	3

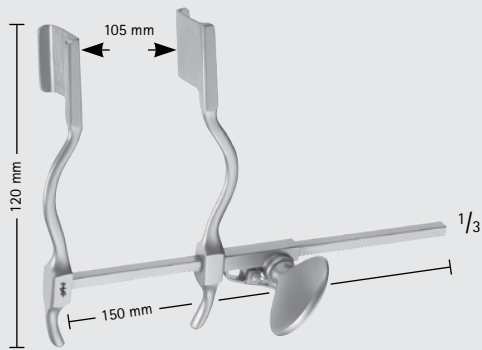

BV512R

HERTZLER Abdominal Retractor

Catalog Number	Blade Size (mm)
BV512R	20 x 25



INCHES

General Surgery

Abdominal Retractors

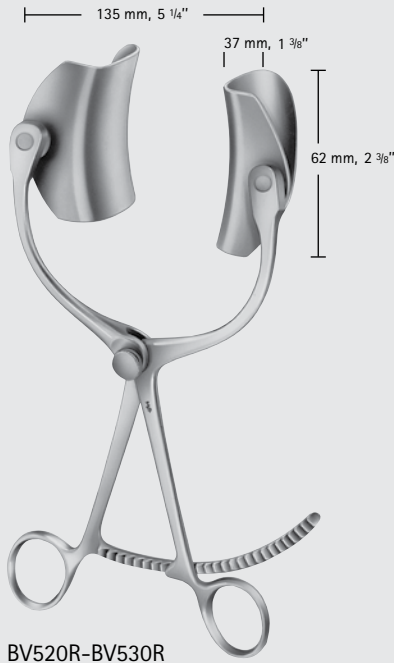

BV520R-BV530R



BV551R

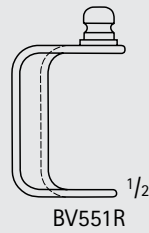

BV551R

COLLIN Abdominal Retractor W/ Ball Snap Closure

Catalog Number	Description
BV530R	SET COMPLETE
BV520R	SPREADER ONLY
BV551R	LATERAL BLADES, Pair, 37 x 62 MM



BV399R

Blade Ejector

Catalog Number	Description	Length (in.)
BV399R	FOR CHANGING BLADES WITH BALL SNAP CLOSURE	4 1/2

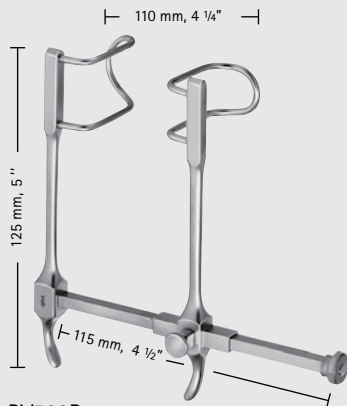

BV500R

GOSSET Abdominal Retractor, Small

Catalog Number	Blade Depth (mm)
BV500R	38

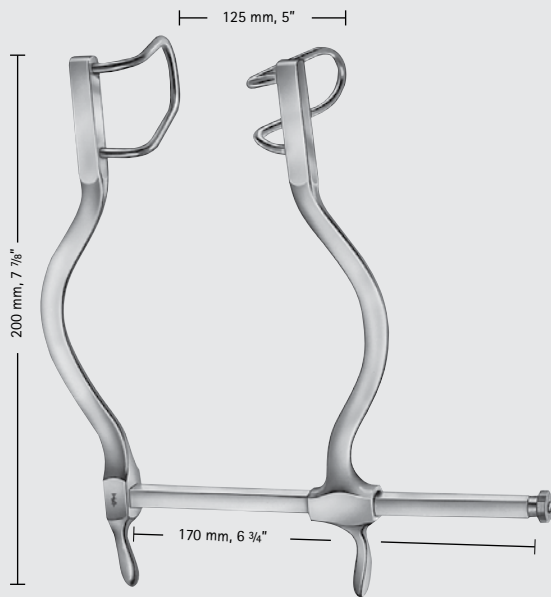

BV502R

GOSSET Abdominal Retractor, Medium

Catalog Number	Blade Depth (mm)
BV502R	55

General Surgery

Abdominal Retractors

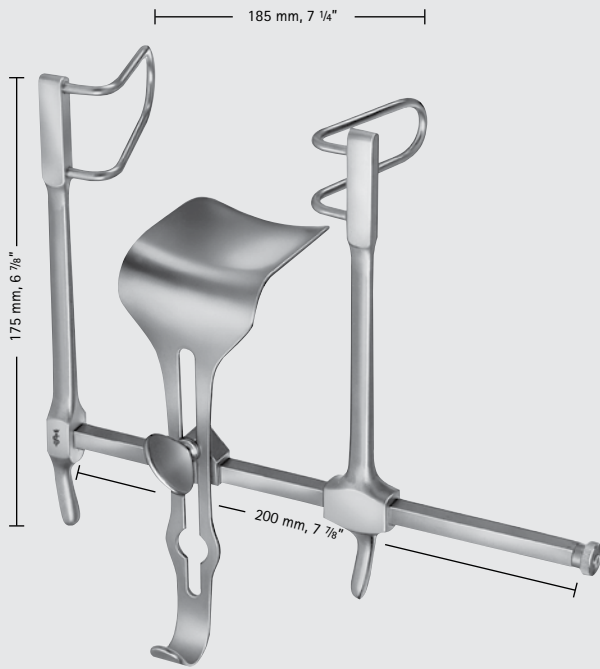

BV505R-BV506R

GOSSET Abdominal Retractor, Large

Catalog Number	Description
BV505R	SET COMPLETE
BV506R	CENTER BLADE ONLY 59 x 57 MM

BV505R Includes:
1 Center Blade BV506R

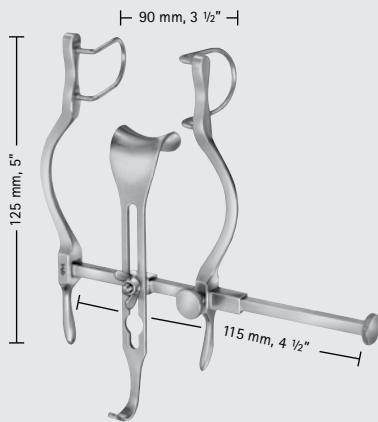

BV601R-BV602R

BALFOUR Baby Abdominal Retractor

Catalog Number	Description
BV601R	SET COMPLETE
BV602R	CENTER BLADE ONLY, 21 x 24 MM

BV601R Includes:
1 Center Blade BV602R

BALFOUR Abdominal Retractor

Catalog Number	Description	Lateral Blades Depth (mm)
BV605R	BALFOUR RETRACTOR, 200 x 155 MM	60
BV608R	BALFOUR RETRACTOR, 200 x 235 MM	60
BV610R	BALFOUR RETRACTOR, 200 x 265 MM	90
BV606R	CENTER BLADE, 47 x 80 MM	-
BV609R	CENTER BLADE, 62 x 76 MM	-
BV611R	CENTER BLADE, 80 x 80 MM	-

BV605R includes BV606R
BV608R includes BV609R
BV610R includes BV611R

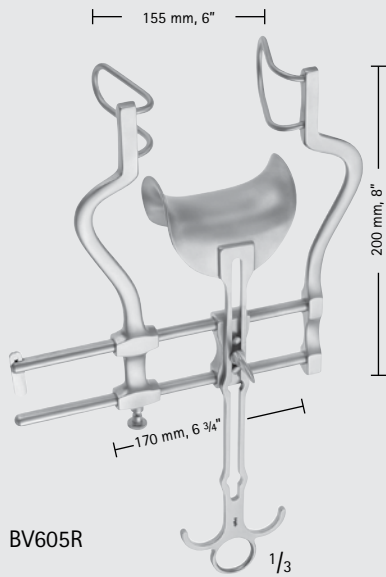

BV605R

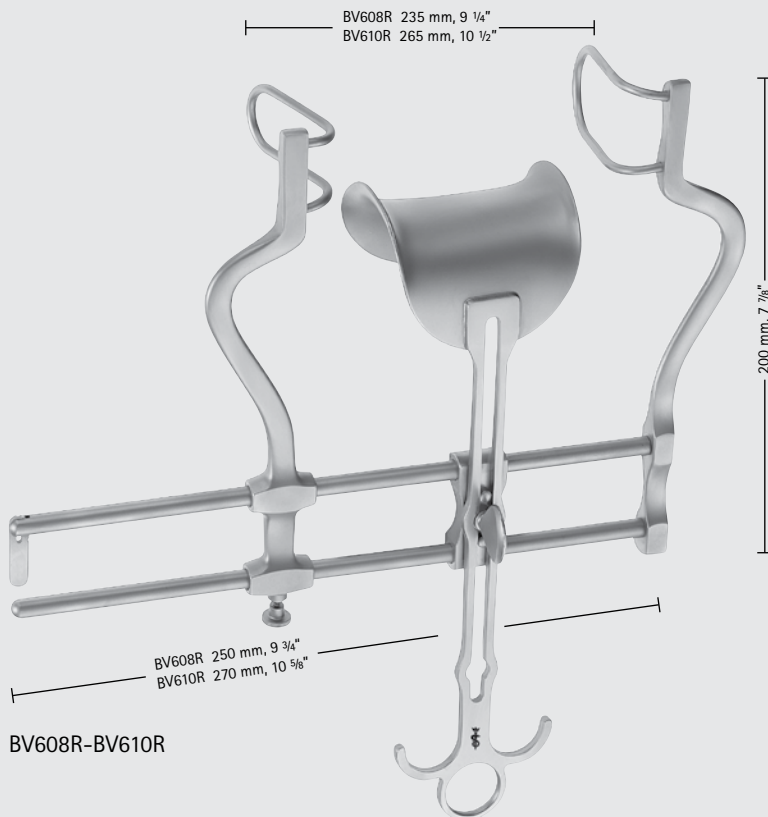

BV608R-BV610R

General Surgery

Abdominal Retractors

GENERAL SURGERY

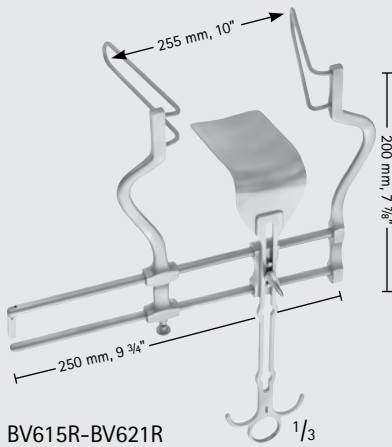
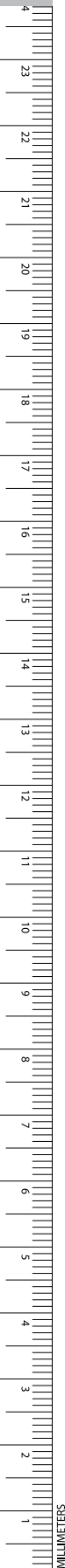

BV615R-BV621R

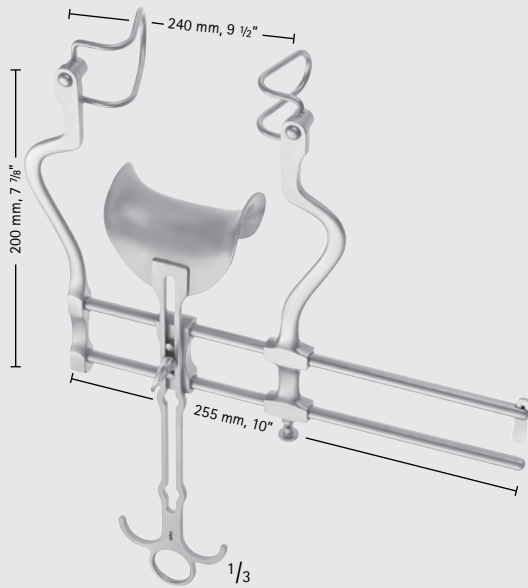

BV632R-BV638R

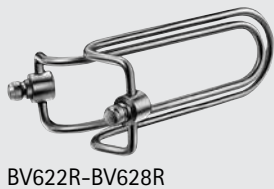

BV622R-BV628R

BALFOUR Abdominal Retractor (continued)

Catalog Number	Description
BV615R	BALFOUR RETRACTOR, 200 x 255 MM COMPLETE W/ BV616R
BV632R	BALFOUR RETRACTOR, COMPLETE W/ BV606R, BV621R, BV622R
BV634R	BALFOUR RETRACTOR, COMPLETE W / BV609R, BV621R, BV624R
BV636R	BALFOUR RETRACTOR, COMPLETE W/ BV611R, BV621R, BV626R
BV638R	BALFOUR RETRACTOR, COMPLETE W/ BV611R, BV621R, BV628R
BV616R	CENTER BLADE, 107 x 59 MM
BV621R	SPREADER ONLY, 200 x 250 MM
BV622R	LATERAL BLADE, PAIR 50 MM
BV624R	LATERAL BLADE, PAIR 60 MM
BV626R	LATERAL BLADE, PAIR 75 MM
BV628R	LATERAL BLADE, PAIR 90 MM

**BALFOUR Side Blade Solid
F/ Retractor MB221R, MB222R**

Catalog Number	Description
MB637R	PAIR, 2 1/2" (64 MM) DEEP
MB638R	PAIR, 3 1/2" (89 MM) DEEP
MB639R	PAIR, 4" (102 MM) DEEP



MB637R



MB638R



MB639R

**BALFOUR Side Blade Wire
F/ Retractor MB221R, MB222R**

Catalog Number	Description
MB577R	PAIR, 2 1/2" (64 MM) DEEP
MB578R	PAIR, 3 1/2" (89 MM) DEEP
MB579R	PAIR, 4" (102 MM) DEEP



MB577R



MB578R

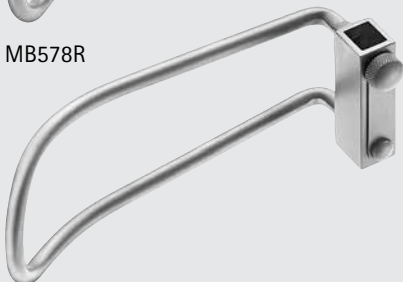

MB579R



INCHES

General Surgery
Abdominal Retractors

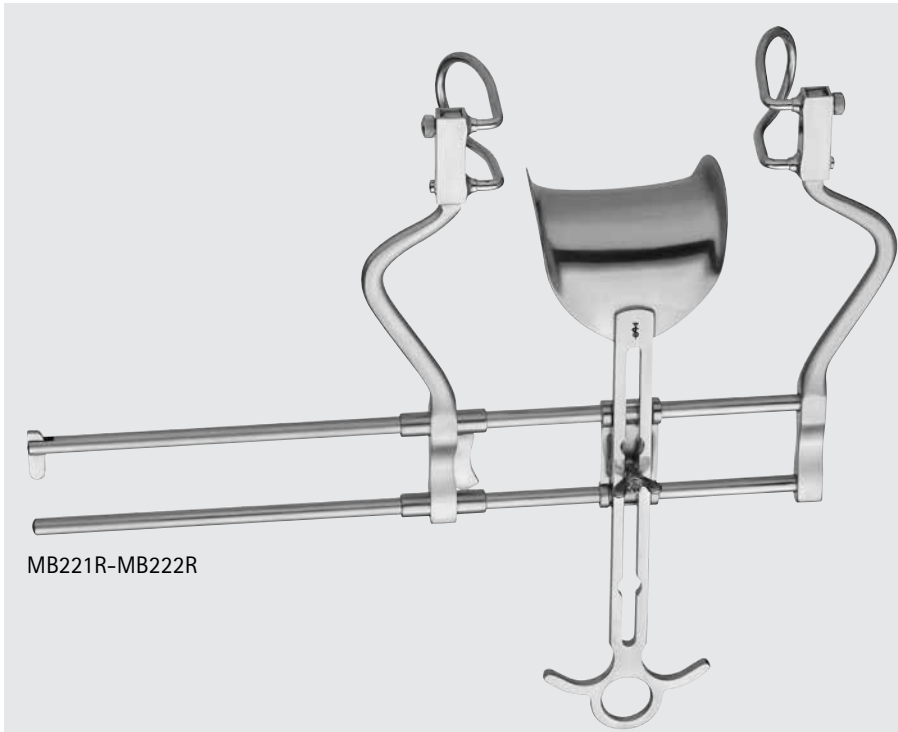

MB221R-MB222R

BALFOUR Retractor W/ Exchangeable Lateral Blades

Catalog Number	Total Width (in.)	Opening Width (in.)	Description
MB221R	16	10 1/2	2 PAIRS OF DETACHABLE BLADES 2 1/2" AND 3 1/2", 1 CENTER BLADE 2 3/4" x 3 1/4"
MB222R	16	8 1/2	2 PAIRS OF DETACHABLE BLADES 2 1/2" AND 3 1/2", 1 CENTER BLADE 2 1/2" x 2 1/2"



MB225

BALFOUR Retractor

Catalog Number	Total Width (in.)	Opening Width (in.)	Description
MB225	13	11	2 LATERAL BLADES 2" x 2" AND 1 1/4" x 2", 1 CENTER BLADE 3" x 10 1/2"

1/3



MB573R-MB574R

DIXON Center Blade

Catalog Number	Blade	Blade Size (mm)
MB573R	MALLEABLE	171 x 51
MB574R	MALLEABLE	267 x 57

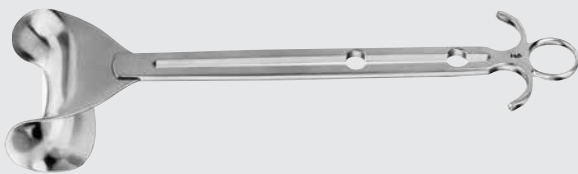

BV617R

**BALFOUR Center Blade For All
BALFOUR Retractors**

Catalog Number	Blade Size (mm)
BV617R	54 x 80



BV618R

Center Blade F/ BV615R

Catalog Number	Blade Size (mm)
BV618R	75 x 80



INCHES

General Surgery
Abdominal Retractors

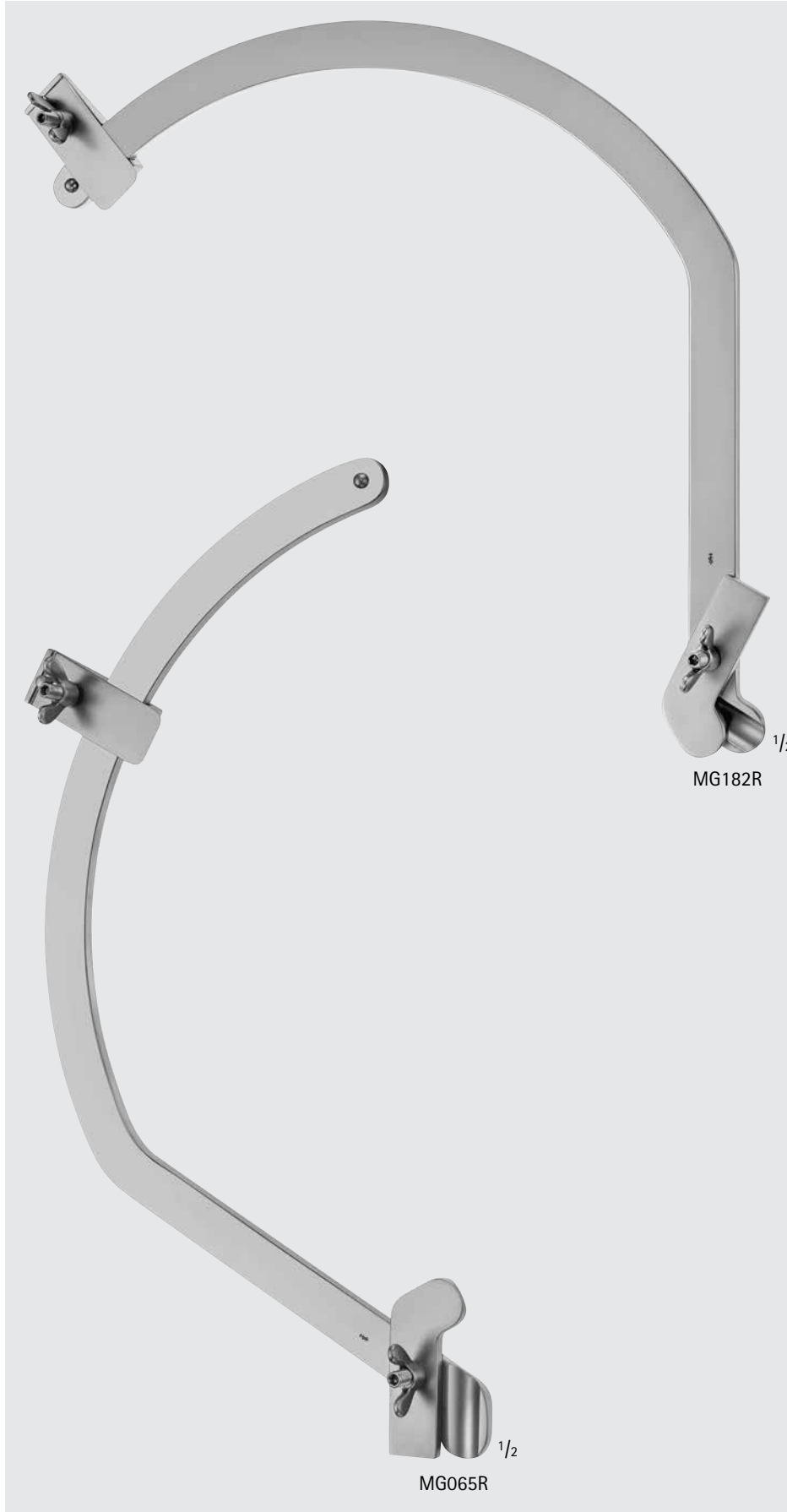
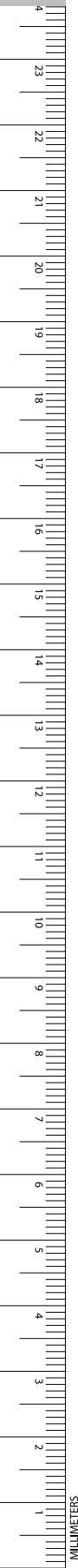

BALFOUR Retractor Extension Arm

Catalog Number	Description	Length (in.)
MG065R	ADULT ABDOMINAL, 4" BLADE F/ RIGHT ARM	9 1/2
MG182R	ADULT ABDOMINAL, 4" BLADE F/ LEFT ARM	9 1/2

General Surgery

Abdominal Retractors

DENIS-BROWNE Abdominal Retractor

Catalog Number	Description
BV650R	COMPLETE SET
BV648R	2 BLADES ONLY, 40 x 30 MM
BV649R	2 BLADES ONLY, 40 x 40 MM
BV646R	BLADE ONLY, 20 x 30 MM

BV650R Includes:
 1 Frame
 2 Blades of each BV648R and BV649R

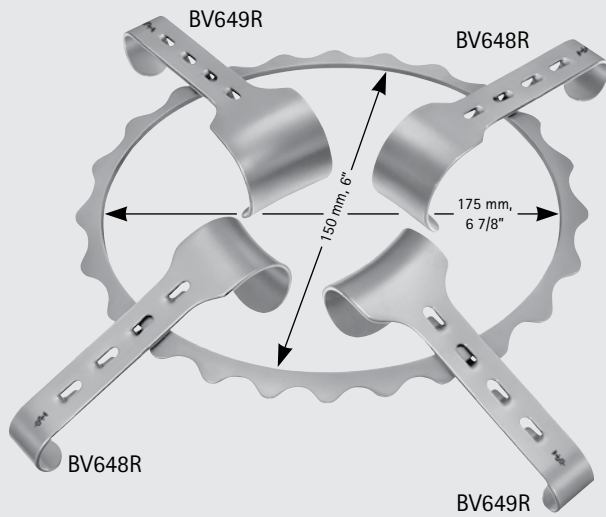

BV646R

General Surgery
Abdominal Retractors

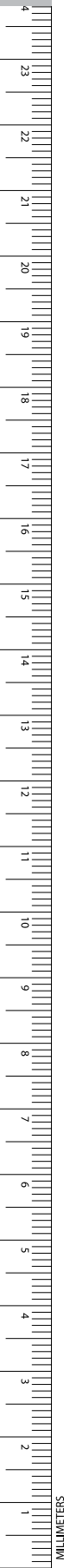

SEMM Abdominal Retractor

Catalog Number	Description	Blade Size (mm)
BV654R	COMPLETE SET	-
BV653R	FRAME	-
BV655R	2 BLADES	46 x 64
BV656R	BLADE	53 x 54
BV657R	BLADE	82 x 97
BV658R	BLADE	98 x 51
BV659R	BLADE	107 x 36

BV654R Includes:
 1 Frame BV653R
 1 Blade of each BV656R, BV657R,
 BV658R and BV659R
 2 Blades BV655R

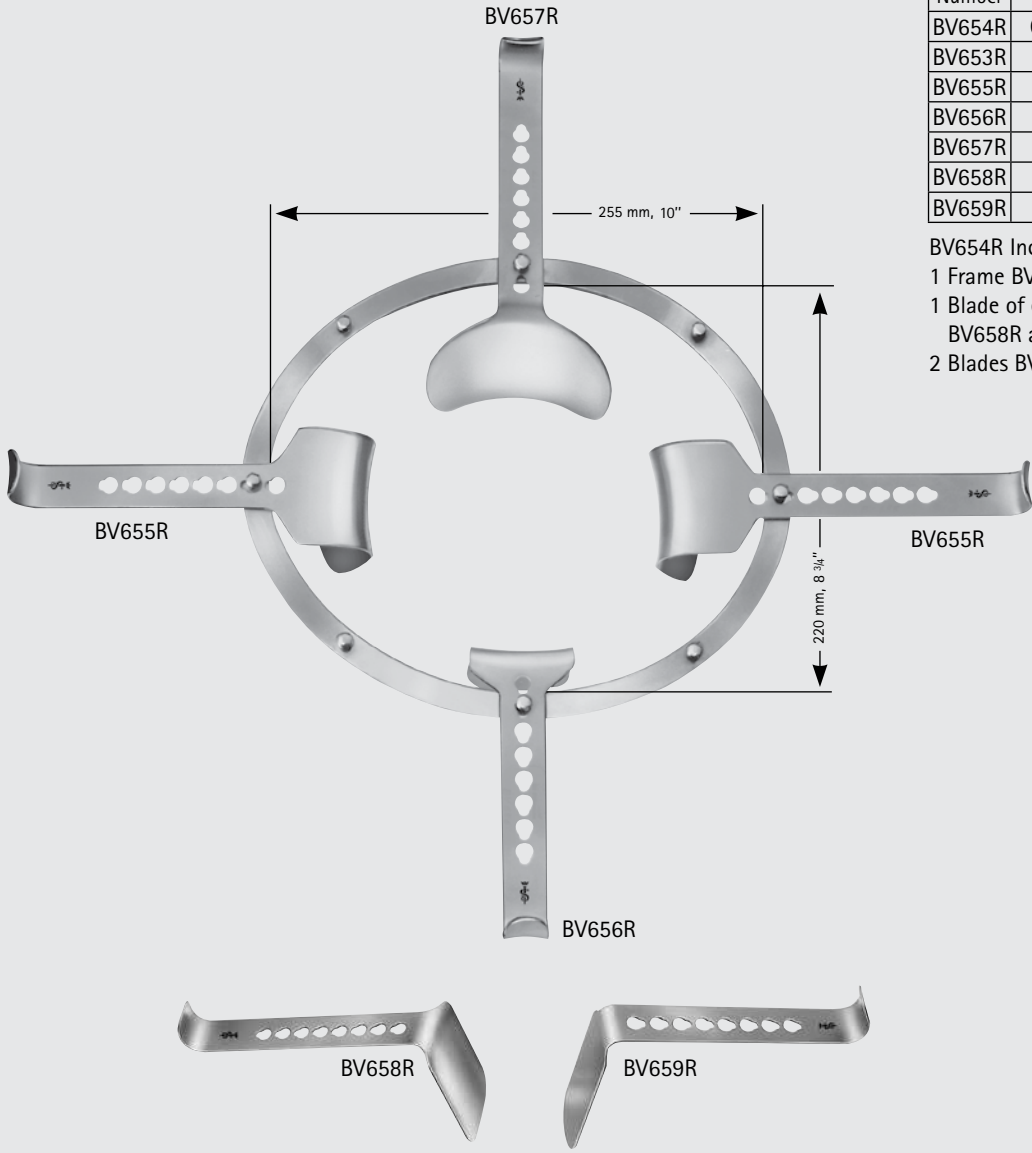

■ For more information about Universal Ring Retractor System see our brochure number DOC380.

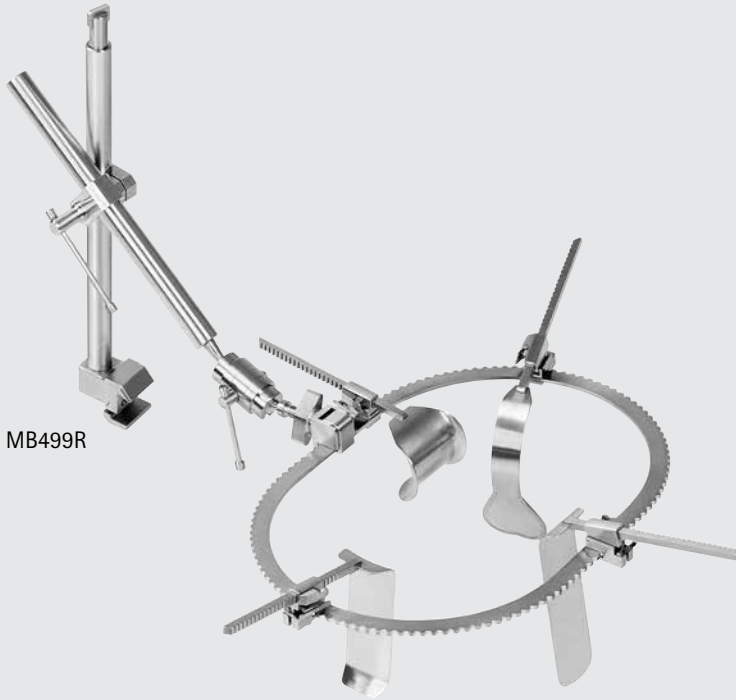

MB499R

Universal Ring Retractor System

Catalog Number	Description
MB499R	COMPLETE SET

Complete System Includes:

MB497	Segmented Medium Oval Ring
MB516	Medium Oval Ring
MB506	Standard Table Clamp 18"
MB488R	Horizontal Flex Bar w/ 360° Rotation 19 1/4"
MB487R	Horizontal Fixed Bar 15 1/2"
MB504	Post Clamp for 1" Bar
MB503	Non-Tilting Blade Clamp (2 each)
MB510	Tilting Blade Clamp (6 each)
MB524	KELLY Retractor Blade 2" x 3" (2 each)
MB525	KELLY Retractor Blade 2" x 4"
MB526	KELLY Retractor Blade 2" x 5"
MB527	KELLY Retractor Blade 2" x 6"
MB529	Malleable Retractor Blade 1 1/2" x 6"
MB530	Malleable Retractor Blade 2" x 6"
MB532	Malleable Retractor Blade 3" x 6"
MB534	BALFOUR Bladder Blade 3" x 2 1/2"
MB544	HARRINGTON Sweetheart Blade 2 1/2" x 5"
MB546	GELPI Point Retractor Blade



MB515-MB517

Oval Ring

Catalog Number	Size	Width x Length (in.)
MB515	SMALL	8 1/2 x 12
MB516	MEDIUM	10 1/2 x 15
MB517	LARGE	12 1/2 x 18 1/2

General Surgery

Universal Ring Retractor System

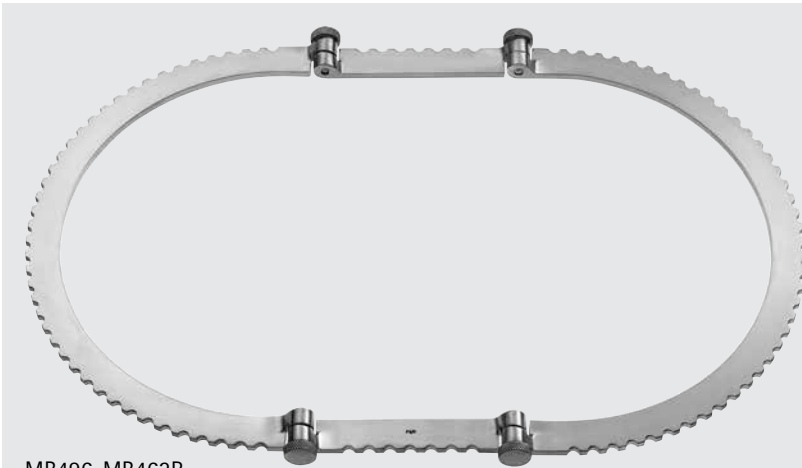

MB496-MB462R

Segmented Oval Ring

Catalog Number	Size	Description	Width x Length (in.)
MB496	SMALL	INCLUDES REMOVABLE 4" SEGMENTS	8 1/2 x 14
MB497	MEDIUM	INCLUDES REMOVABLE 8" SEGMENTS	10 1/2 x 19 1/2
MB498	LARGE	INCLUDES REMOVABLE 6" SEGMENTS	12 1/2 x 19 1/2
MB462R	X-LARGE	INCLUDES REMOVABLE 6" SEGMENTS	16 x 22



MB471R-MB473R

Segments for Segmented Oval Ring, Pair

Catalog Number	Length (in.)
MB471R	4
MB472R	6
MB473R	8



MB564

URRS Segmented Ring Screw

Catalog Number
MB564

General Surgery

Universal Ring Retractor System

Round Ring

Catalog Number	Size	Diameter (in.)
MB519	SET	-
MB520	SMALL	8 1/2
MB521	MEDIUM	10 1/2
MB522	LARGE	12 1/2

MB519 Includes:
1 Ring of each MB520-MB522

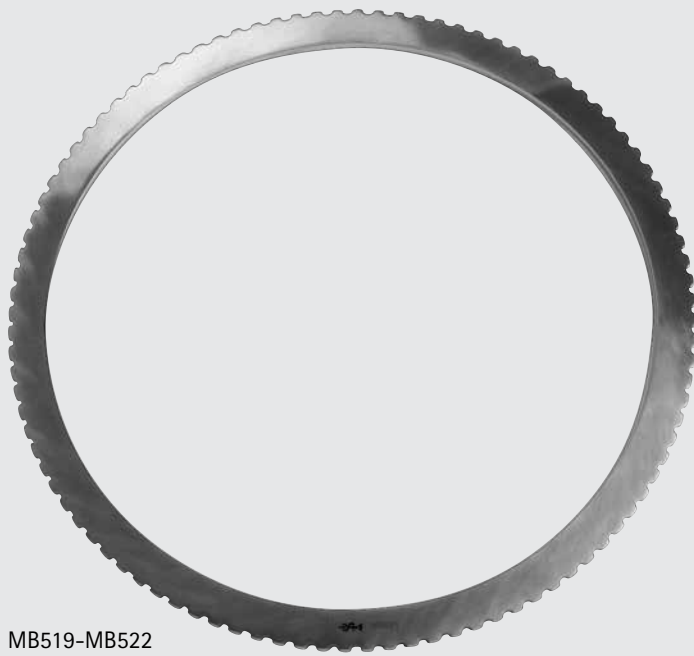

MB519-MB522

Segmented Round Ring

Catalog Number	Size	Diameter (in.)
MB825R	SMALL	8 1/2
MB826R	MEDIUM	10 1/2
MB827R	LARGE	12 1/2
MB828R	X-LARGE	16

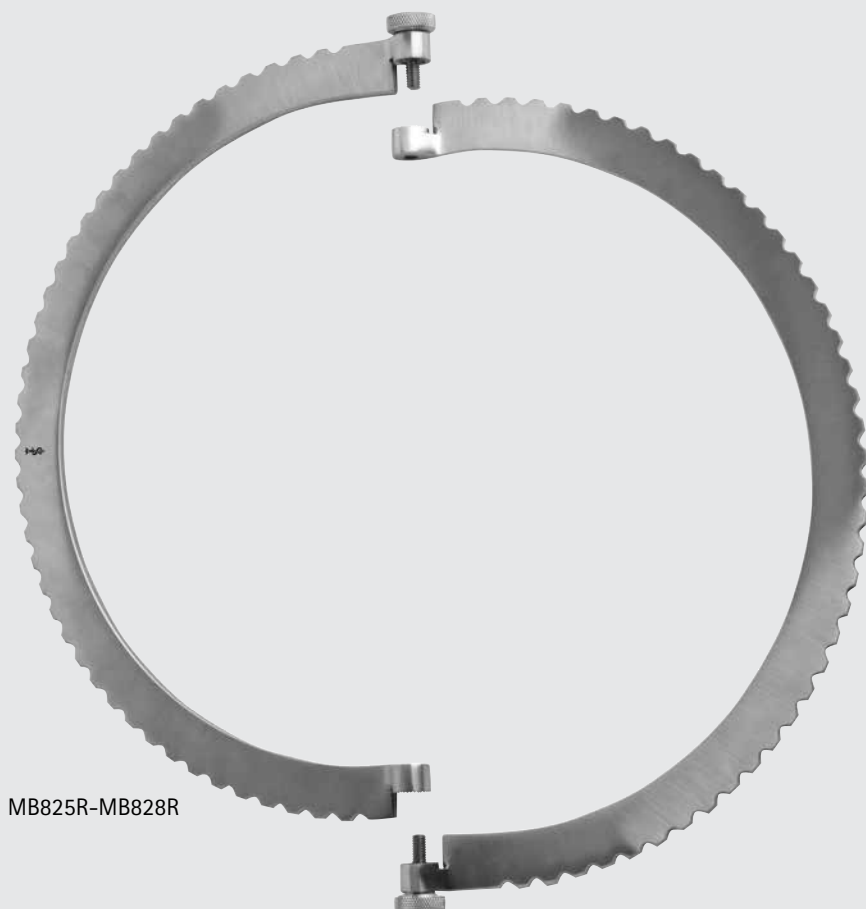

MB825R-MB828R



INCHES

General Surgery

Universal Ring Retractor System

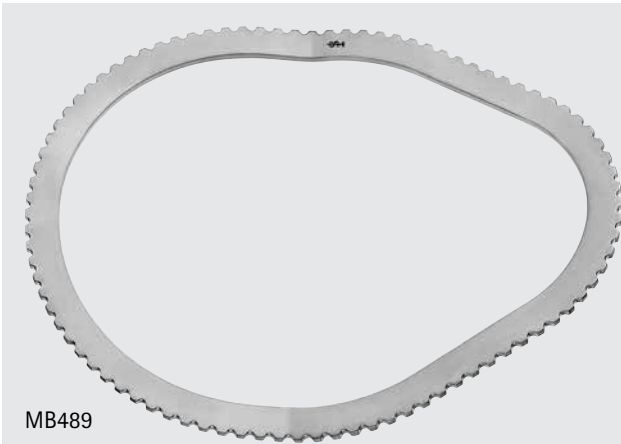

MB489

Vaginal Ring

Catalog Number	Description	Width x Length (in.)
MB489	20° ANGLE	8 x 10 1/2



MG511R

1/2

Tilt and Swivel Clamp

Catalog Number
MG511R

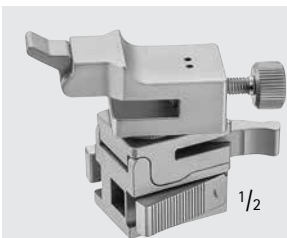

MB973R

1/2

Multi Directional Blade Clamp

Catalog Number
MB973R



MB503

Non-Tilting Blade Clamp

Catalog Number
MB503

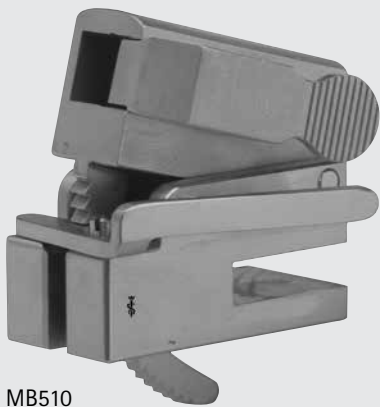

MB510

Tilting Blade Clamp

Catalog Number
MB510



MB504

Post Clamp

Catalog Number
MB504



General Surgery

Universal Ring Retractor System



Table Clamp

Catalog Number	Working Length (in.)	Length (in.)
MB506	15	18
MB460R	21	24



MB460R-MB506

Flat Table Clamp

Catalog Number	Working Length (in.)	Total Length (in.)
MB670R	11 1/2	18
MB821R	17	24

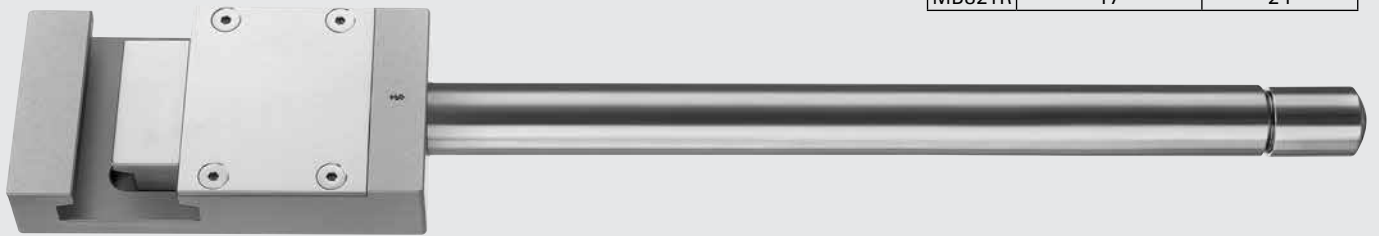

MB670R-MB821R

Horizontal Fixed Bar

Catalog Number	Length (in.)
MB487R	15 1/2
MB823R	22



MB487R-MB823R

Horizontal Flex Bar W/ 360° Rotation

Catalog Number	Length (in.)
MB488R	19
MB824R	22 1/2



MB488R-MB824R

Vertical Extension Bar

Catalog Number	Length (in.)
MB508	12
MB822R	14



MB508-MB822R

Adapter For Attaching Handheld Retractors

Catalog Number
MB509



MB509



INCHES

General Surgery

Universal Ring Retractor System

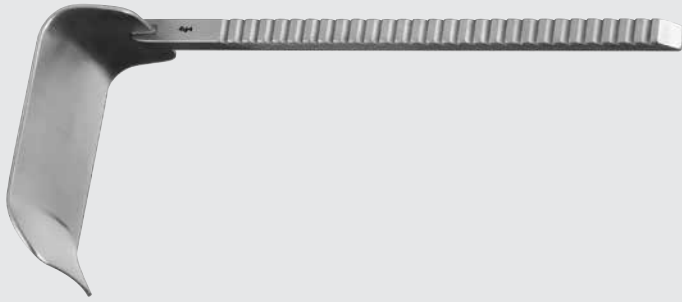

MB469R-MB555

KELLY Retractor Blade

Catalog Number	Description	Width x Depth (in.)
MB555	-	1 x 1 1/2
MB556	-	1 x 2 1/2
MB936R	-	2 x 1 1/2
MB937R	-	2 x 2 1/2
MB524	-	2 x 3
MB525	-	2 x 4
MB526	-	2 x 5
MB527	-	2 x 6
MB469R	BARIATRIC	2 x 8



MB938A-MB943A

Aluminum KELLY Retractor Blade

Catalog Number	Description	Width x Depth (in.)
MB938A	-	2 x 2 1/2
MB939A	-	2 x 3
MB940A	-	2 x 4
MB941A	-	2 x 5
MB942A	-	2 x 6
MB943A	BARIATRIC	2 x 8



MB467R-MB860R

Malleable Retractor Blade

Catalog Number	Description	Width x Depth (in.)
MB860R	-	3/4 x 2
MB861R	-	3/4 x 3
MB862R	-	1 x 1
MB863R	-	1 x 4
MB864R	-	1 x 5
MB865R	-	1 1/2 x 3
MB866R	-	1 1/2 x 4
MB529	-	1 1/2 x 6
MB867R	-	1 1/2 x 8
MB530	-	2 x 6 1/2
MB531	-	2 x 8
MB463R	BARIATRIC	2 x 10
MB532	-	3 x 6
MB464R	BARIATRIC	3 x 10
MB466R	BARIATRIC	3 x 12
MB869R	BARIATRIC	4 x 8
MB465R	BARIATRIC	4 x 10
MB467R	BARIATRIC	4 x 12

Aluminum Malleable Retractor Blade,
Flat

Catalog Number	Description	Width x Depth (in.)
MB954A	-	1 1/2 x 6
MB955A	-	2 x 6
MB956A	-	2 x 8
MB957A	-	3 x 6
MB958A	BARIATRIC	2 x 10
MB959A	BARIATRIC	3 x 10



MB954A-MB959A



INCHES

General Surgery

Universal Ring Retractor System



MB557-MB559

RICHARDSON Retractor

Catalog Number	Width x Depth (in.)
MB557	3/4 x 1
MB558	3/4 x 2
MB559	1 x 1 1/4



MB470R-MB534

BALFOUR Bladder Blade

Catalog Number	Description	Width x Depth (in.)
MB534	-	3 x 2 1/2
MB535	-	3 x 3 1/4
MB470R	BARIATRIC	3 x 3 1/2

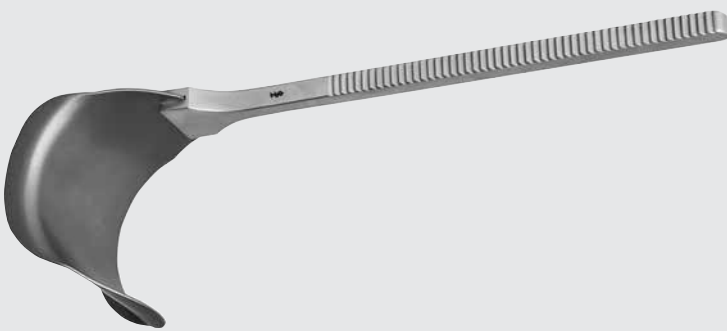

MB829A-MB830A

Aluminum BALFOUR Bladder Blade

Catalog Number	Width x Depth (in.)
MB829A	2 x 2 3/8
MB830A	3 x 2 1/2



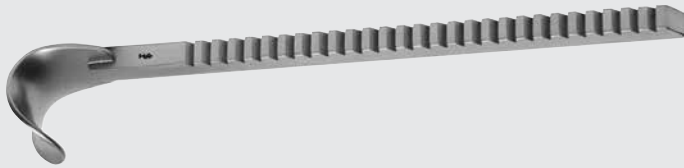

MB968R-MB969R

MAYO Retractor Blade

Catalog Number	Width x Depth (in.)
MB968R	1 1/4 x 1 1/4
MB969R	2 x 2

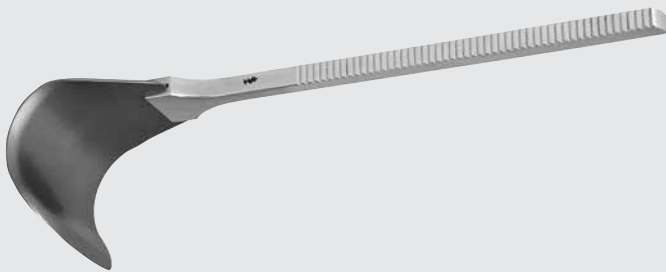

MB970A

Aluminum MAYO Retractor Blade

Catalog Number	Width x Depth (in.)
MB970A	2 3/4 x 2



MB537-MB539

DEEVER Retractor Blade

Catalog Number	Width x Depth (in.)
MB537	1 x 4 1/2
MB538	1 1/2 x 4 1/2
MB539	2 x 4 1/2



MB492-MB493

DEEVER Vaginal Retractor Blade

Catalog Number	Description	Width x Depth (in.)
MB492	SMALL	1 x 3 1/2
MB493	LARGE	1 x 5



INCHES

General Surgery

Universal Ring Retractor System



MB490

Vaginal Retractor Posterior Blade

Catalog Number	Width x Depth (in.)
MB490	1 x 4 1/2



MB491

Vaginal Retractor Lateral Blade

Catalog Number	Width x Depth (in.)
MB491	1 x 3



MB871R

ST. MARK'S Deep Pelvic Retractor Blade

Catalog Number	Width x Depth (in.)
MB871R	2 3/8 x 7 1/2



MB494-MB495

Rectal Blade

Catalog Number	Description	Width x Depth (in.)
MB494	SMALL	7/8 x 2 7/8
MB495	LARGE	7/8 x 3 7/8

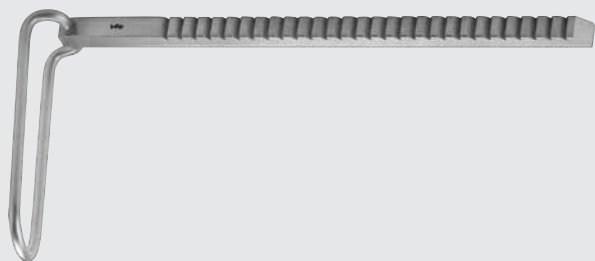

MB541

Skin Incision Blade

Catalog Number	Width x Depth (in.)
MB541	1 1/8 x 3 1/4

General Surgery

Universal Ring Retractor System



MB543-MB832R

HARRINGTON Sweetheart Blade

Catalog Number	Description	Width x Depth (in.)
MB543	-	1 1/2 x 5
MB544	-	2 1/2 x 5 5/8
MB468R	BARIATRIC	3 1/2 x 10
MB832R	BARIATRIC	4 1/2 x 10

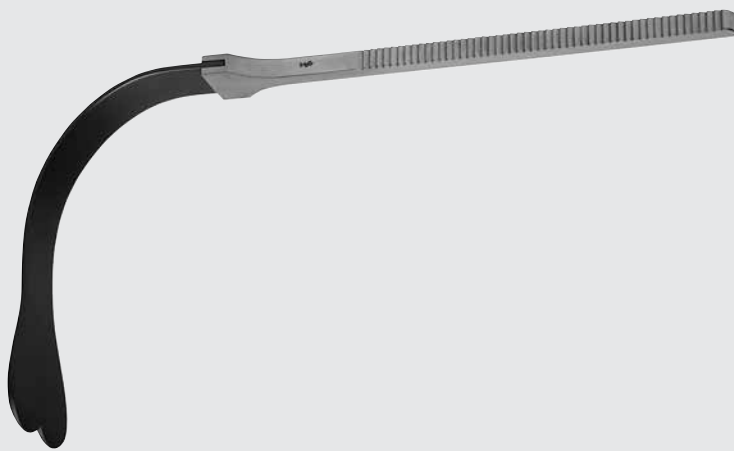

MB833A-MB835A

Aluminum HARRINGTON Sweetheart Blade

Catalog Number	Description	Width x Depth (in.)
MB833A	-	2 1/2 x 4
MB834A	-	3 1/2 x 8
MB835A	BARIATRIC	3 1/2 x 10



MB546

GELPI Point Retractor Blade

Catalog Number
MB546

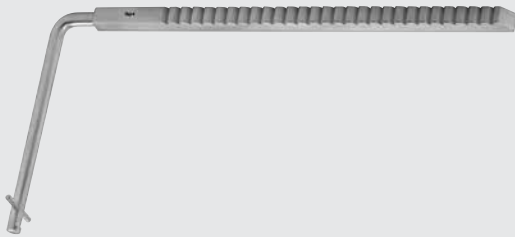

MB548-MB549

SCOVILLE Hook Retractor Blade

Catalog Number	Description	Depth (in.)
MB549	SMALL	2
MB548	LARGE	3 1/4



MB566-MB568

Rake Retractor

Catalog Number	Description	Width x Depth (in.)
MB566	3 PRONGS	2/3 x 3/4
MB567	4 PRONGS	3/4 x 1/3
MB568	6 PRONGS	1 x 1/3



MB551-MB553

MEYERDING Retractor Blade

Catalog Number	Width x Depth (in.)
MB551	1 x 3 1/3
MB552	2 x 3 3/4
MB553	2/3 x 2 1/3



General Surgery

Universal Ring Retractor System

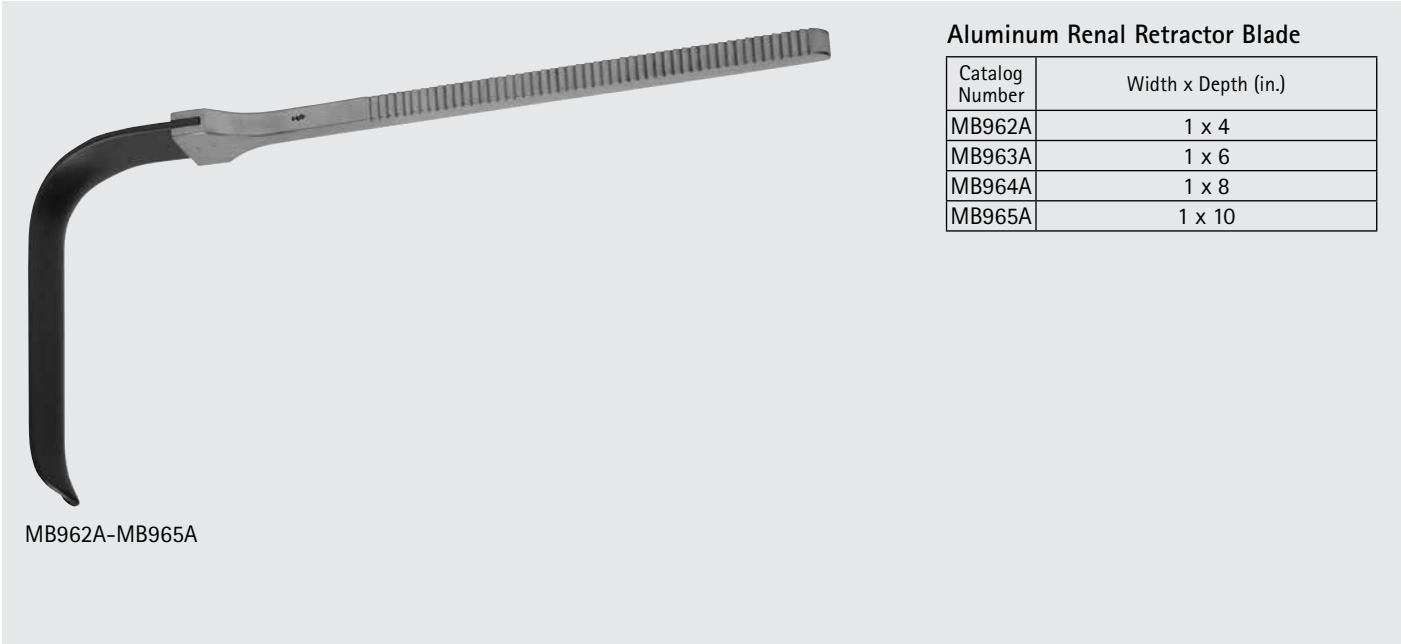

Aluminum Renal Retractor Blade

Catalog Number	Width x Depth (in.)
MB962A	1 x 4
MB963A	1 x 6
MB964A	1 x 8
MB965A	1 x 10

MB962A-MB965A

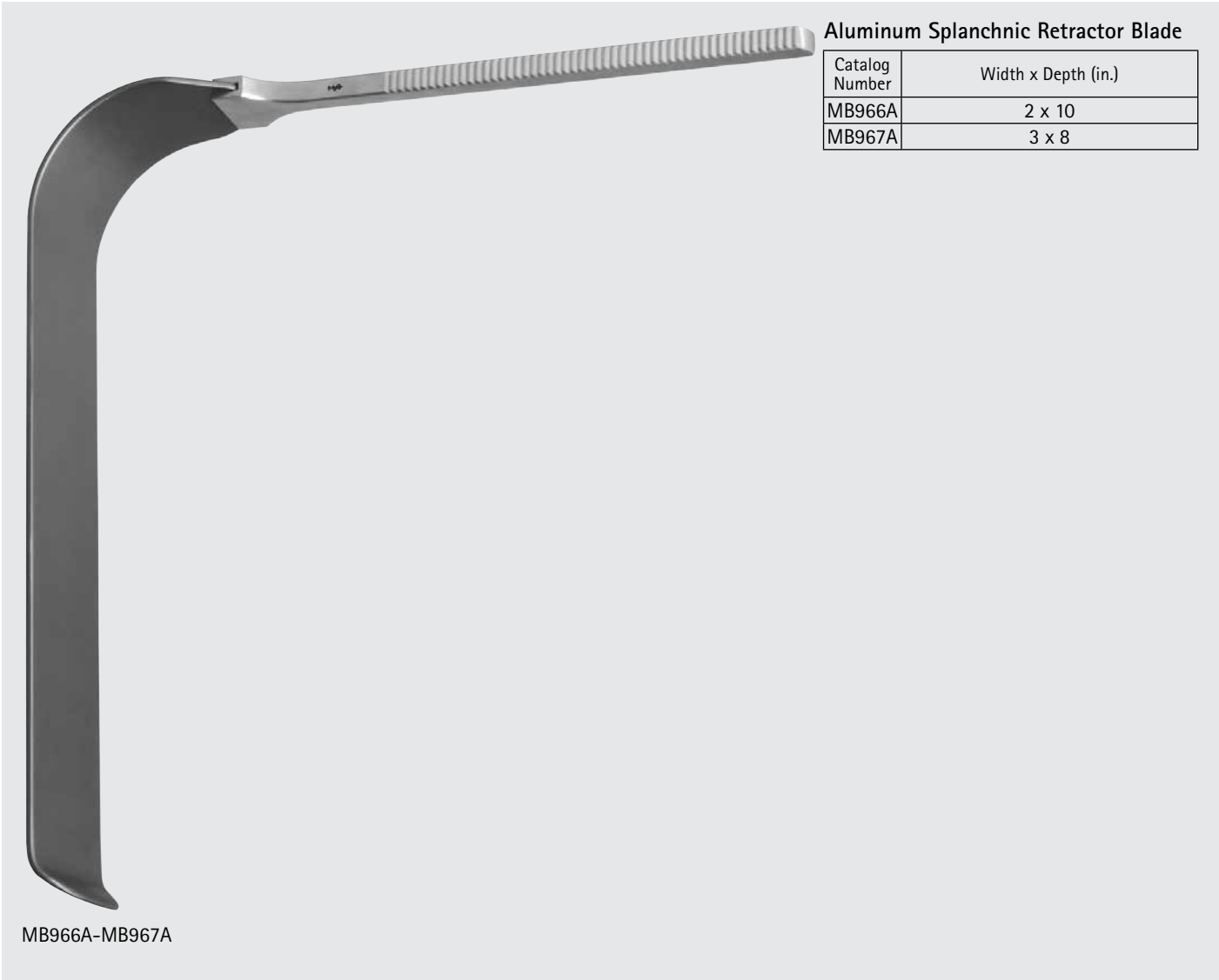

Aluminum Splanchnic Retractor Blade

Catalog Number	Width x Depth (in.)
MB966A	2 x 10
MB967A	3 x 8

MB966A-MB967A

Perforated Super Malleable Retractor
 Blade

Catalog Number	Width x Depth (in.)
MB960R	2 x 9
MB961R	3 x 9

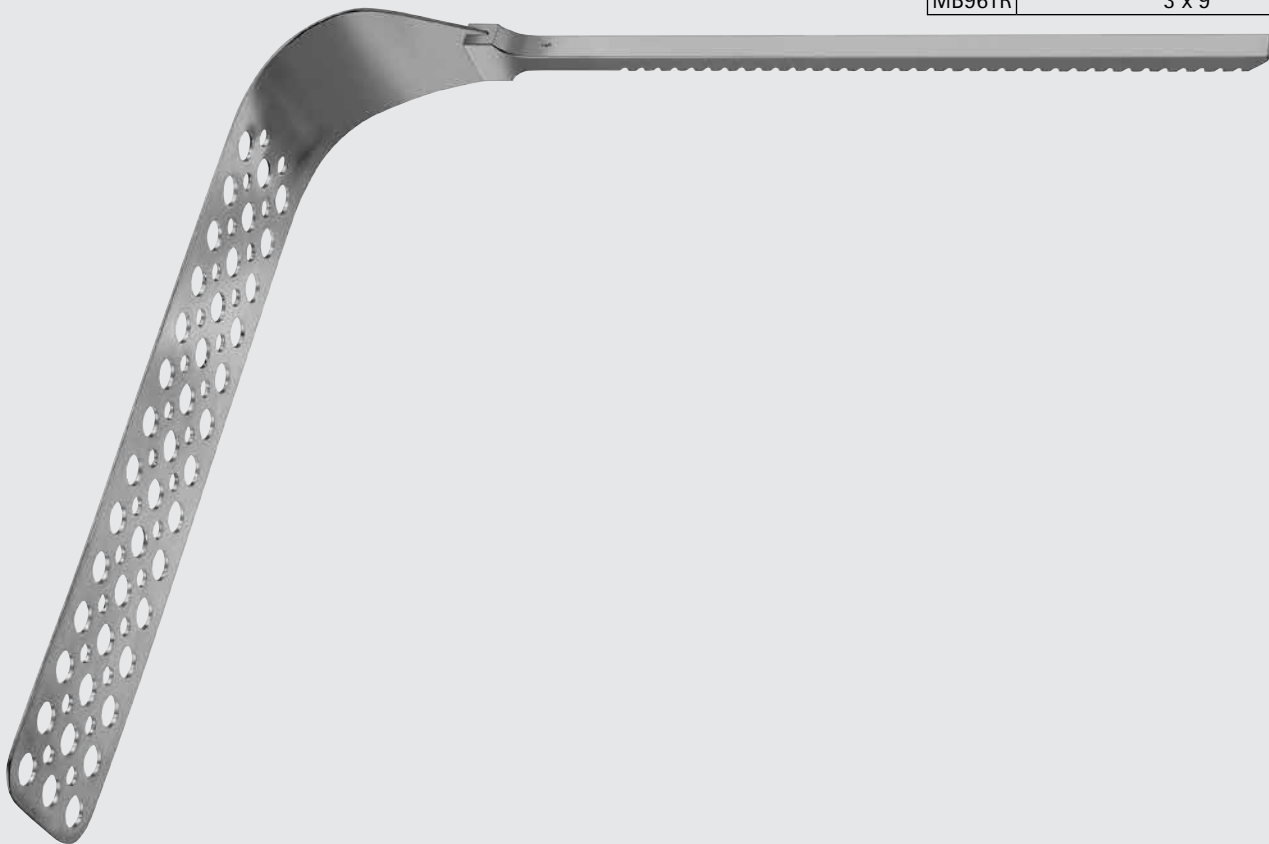

MB960R-MB961R

YU-HOLTGREWE Malleable Retractor
 Blade

Catalog Number	Width x Depth (in.)
MB870R	2 1/2 x 6

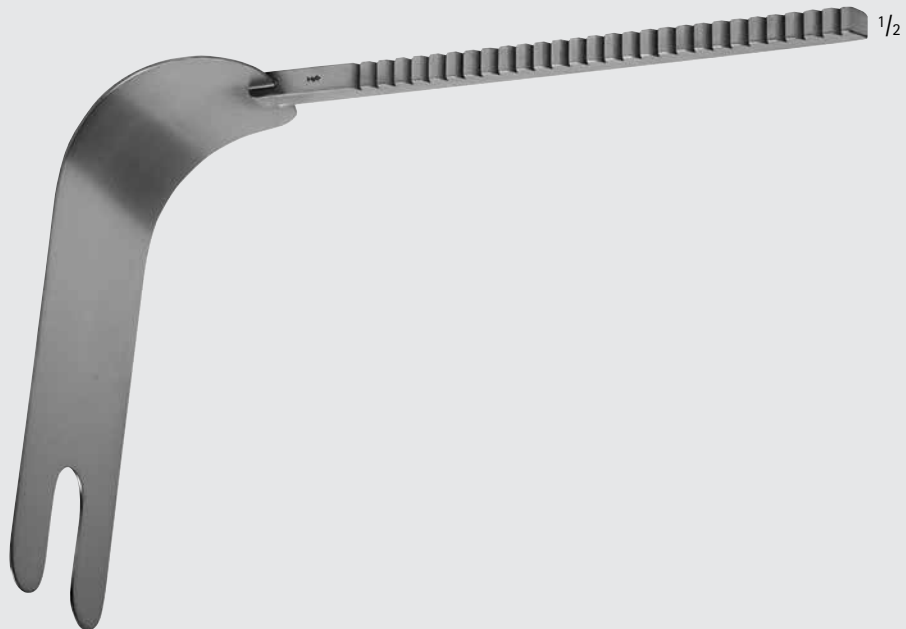

MB870R



INCHES

General Surgery

Self Retaining Retractors



BV001R



BV001R

FINSEN Retractor

Catalog Number	Tip	Blade End	Length (in.)
BV001R	SHARP	2 x 3 PRONGS	2



BV002R

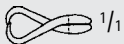

BV002R

FINSEN Retractor

Catalog Number	Tip	Blade End	Length (in.)
BV002R	SHARP	3 x 4 PRONGS	2 3/4



BV003R

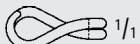

BV003R

FINSEN Modified Retractor

Catalog Number	Tip	Blade End	Length (in.)
BV003R	BLUNT	2 x 3 PRONGS	3



BV005R



BV005R

FINSEN Retractor

Catalog Number	Tip	Blade End	Length (in.)
BV005R	SHARP	3 x 4 PRONGS	2 3/4



BV014R

PARSONNET Epicardial Retractor

Catalog Number	Tip	Blade End	Length (in.)
BV014R	SHARP	3 x 3 PRONGS	2

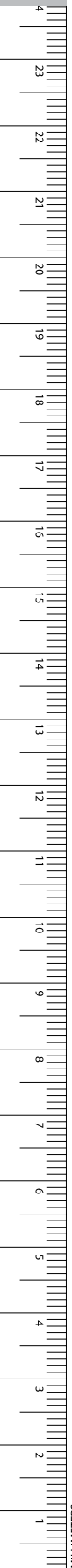



BV006R-BV007R



BV006R

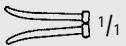

BV007R

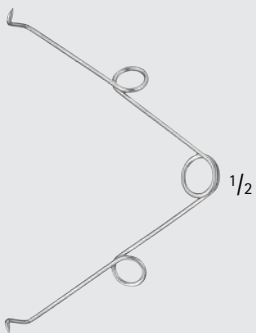

MD471

Spring Wire Retractor

Catalog Number	Tip	Prongs	Length (in.)
BV006R	BLUNT	3 x 3	1 3/4
BV007R	BLUNT	3 x 3	2 1/4
MD471	SHARP	1 x 1	3

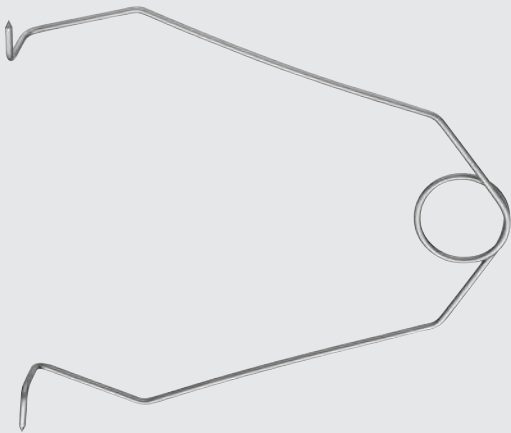

MB196R-MB777R

Spring Wire Retractor

Catalog Number	Size	Length (in.)
MB777R	SMALL	5
MB778R	MEDIUM	5 1/8
MB196R	LARGE	9



INCHES

General Surgery

Self Retaining Retractors



BV010R-BV011R



BV010R



BV011R

ALM Retractor

Catalog Number	Tip	Blade End	Length (in.)
BV010R	SHARP	4 x 4 PRONGS	2 3/4
BV011R	SHARP	4 x 4 PRONGS	4



BV008R-BV015R



BV008R



BV015R

HEISS Self-Retaining Retractor

Catalog Number	Tip	Blade End	Length (in.)
BV015R	SHARP	4 x 4 PRONGS	4
BV008R	BLUNT	4 x 4 PRONGS	4

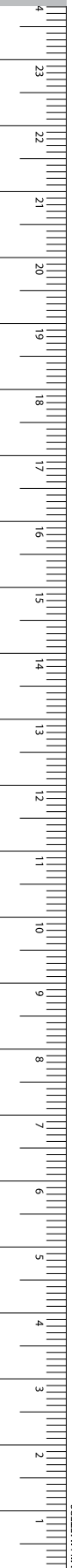

WEITLANER Retractor

Catalog Number	Tip	Blade End	Length (in.)
BV073R	BLUNT	2 x 3 PRONGS	4 1/4
MA438R	BLUNT	3 x 3 PRONGS	4 1/4
BV074R	BLUNT	3 x 4 PRONGS	5 1/8
BV075R	BLUNT	3 x 4 PRONGS	6 1/2
BV104R	BLUNT/ DEEP	3 x 4 PRONGS	5 1/8

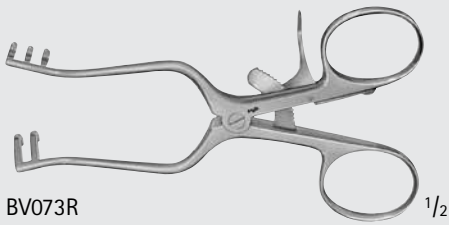

BV073R 1/2



MA438R 1/2

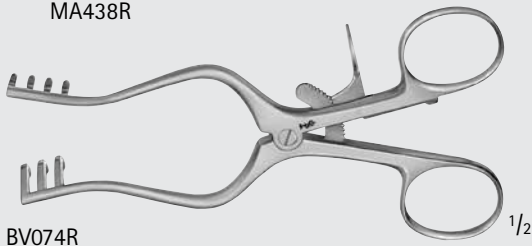

BV074R 1/2

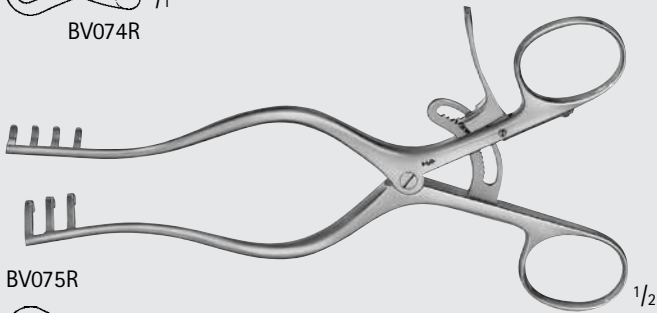
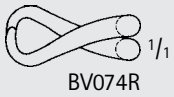

BV075R 1/2

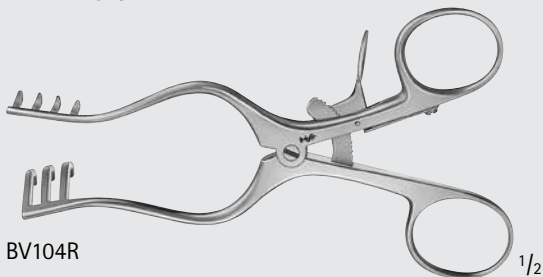
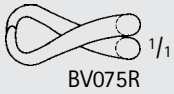

BV104R 1/2

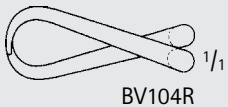

BV104R



INCHES

General Surgery

Self Retaining Retractors

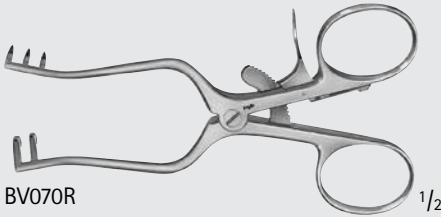
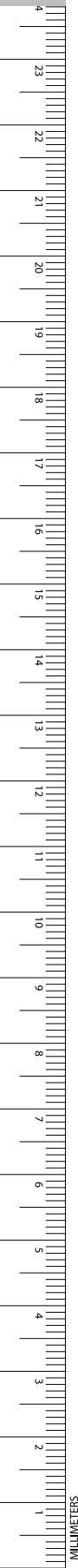

BV070R $\frac{1}{2}$



BV070R $\frac{1}{1}$

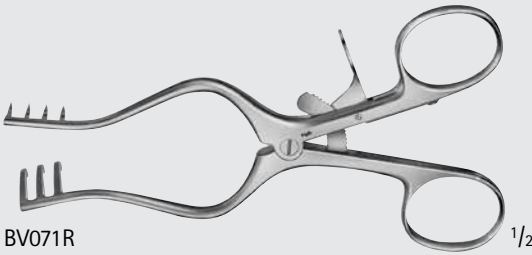

BV071R $\frac{1}{2}$



BV071R $\frac{1}{1}$

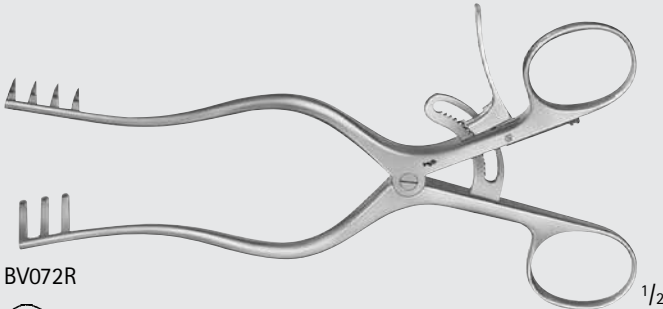

BV072R $\frac{1}{2}$

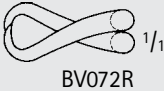

BV072R $\frac{1}{1}$

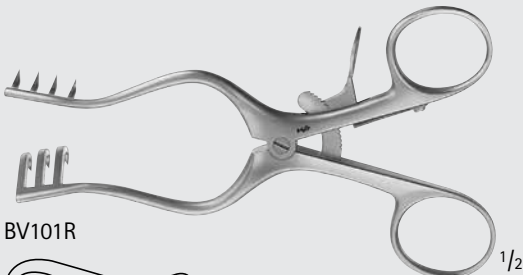

BV101R $\frac{1}{2}$

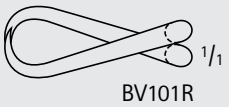

BV101R $\frac{1}{1}$

WEITLANER Retractor

Catalog Number	Tip	Blade End	Length (in.)
BV070R	SHARP	2 x 3 PRONGS	4 1/4
BV071R	SHARP	3 x 4 PRONGS	5 1/8
BV072R	SHARP	3 x 4 PRONGS	6 1/2
BV101R	SHARP/DEEP	3 x 4 PRONGS	5 1/8
BV066R	SEMI-S	2 x 3 PRONGS	4 1/4
BV067R	SEMI-S	3 x 4 PRONGS	5 1/8
BV068R	SEMI-S	3 x 4 PRONGS	6 1/2

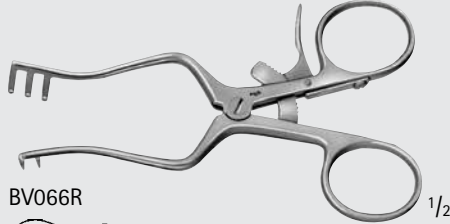

BV066R $\frac{1}{2}$



BV066R $\frac{1}{1}$

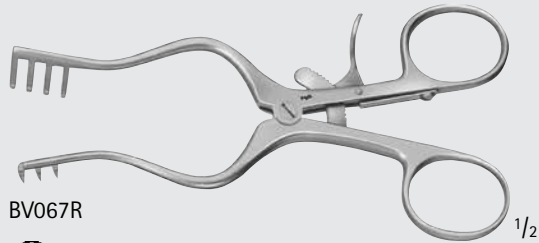

BV067R $\frac{1}{2}$

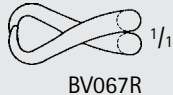

BV067R $\frac{1}{1}$

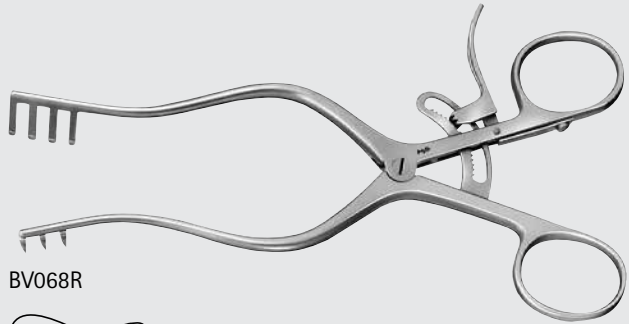

BV068R $\frac{1}{2}$

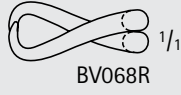

BV068R $\frac{1}{1}$

WULLSTEIN Retractor

Catalog Number	Tip	Blade End	Length (in.)
BV076R	SHARP	3 x 3 PRONGS	5
BV077R	BLUNT	3 x 3 PRONGS	5

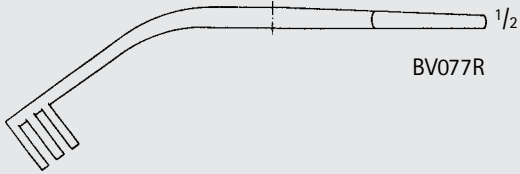
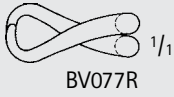
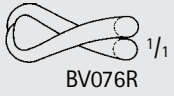

Baby ADSON Retractor, Hinged

Catalog Number	Tip	Blade End	Length (in.)
BV085R	SEMI-S	3 x 4 PRONGS	5 1/2
BV094R	SEMI-S	3 x 4 PRONGS	6 1/2

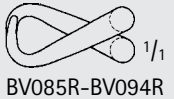
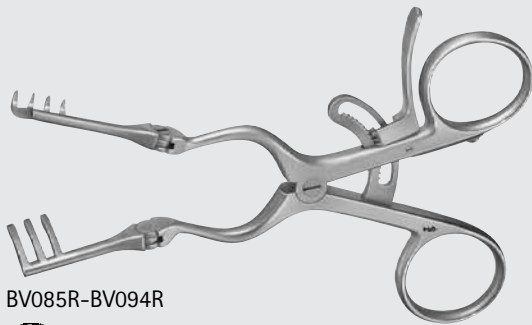

Baby ADSON Retractor, Angled

Catalog Number	Tip	Blade End	Length (in.)
MG007R	BLUNT	4 x 4 PRONGS	7 1/2

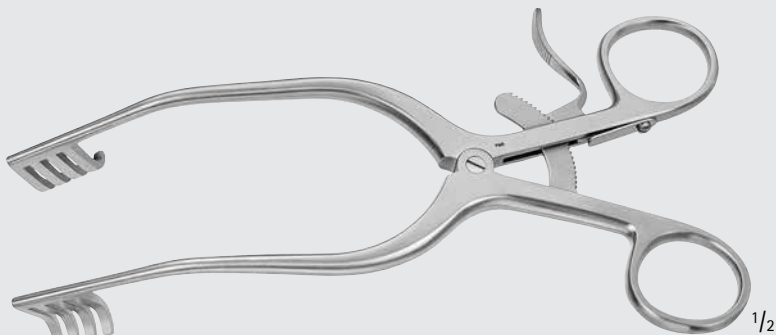

MG007R



INCHES

General Surgery

Self Retaining Retractors



BV200R-BV209R

WEITLANER Retractor

Catalog Number	Tip	Blade End	Length (in.)
BV200R	SHARP	3 x 4 PRONGS	7 7/8
BV206R	SHARP	3 x 4 PRONGS	9 1/2
BV208R	SHARP	5 x 6 PRONGS	10
BV201R	BLUNT	3 x 4 PRONGS	7 7/8
BV207R	BLUNT	3 x 4 PRONGS	9 1/2
BV209R	BLUNT	5 x 6 PRONGS	10

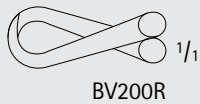

BV200R

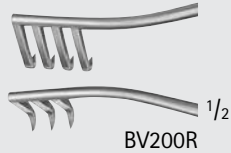

BV200R

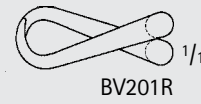

BV201R

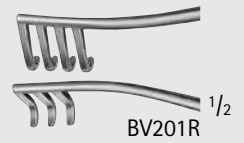

BV201R



BV206R

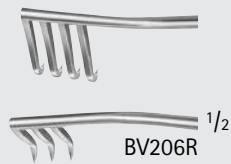

BV206R

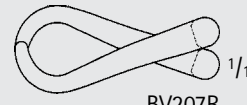

BV207R

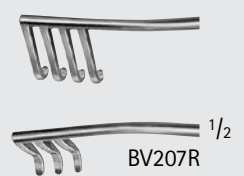

BV207R



BV208R

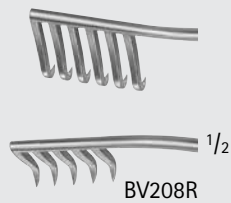

BV208R

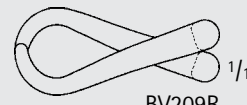

BV209R

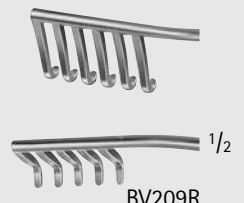

BV209R

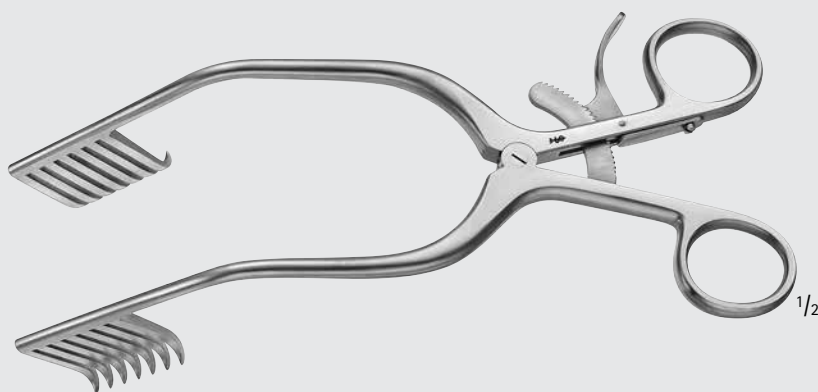

MB476R

MISKIMON Cerebellar Retractor

Catalog Number	Tip	Blade End	Length (in.)
MB476R	SHARP	7 x 7 PRONGS	7 7/8

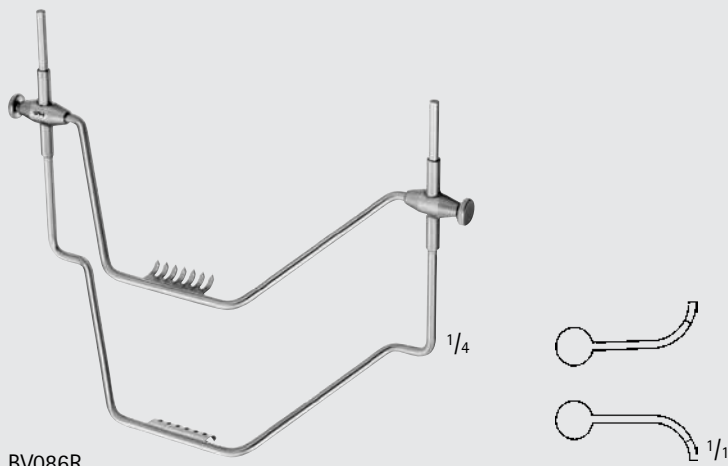

MB476R

The image shows a Thyroid Retractor (BV086R) in two views. The main view is a perspective drawing of the retractor, which has two long, curved arms with serrated ends. A central rod with a handle is used to adjust the opening. A dimension of 1/4 is indicated near the handle. To the right, a smaller detail drawing shows the curved end of the arm with a dimension of 1/1.

Thyroid Retractor

Catalog Number	
	BV086R

BV086R

BV086R

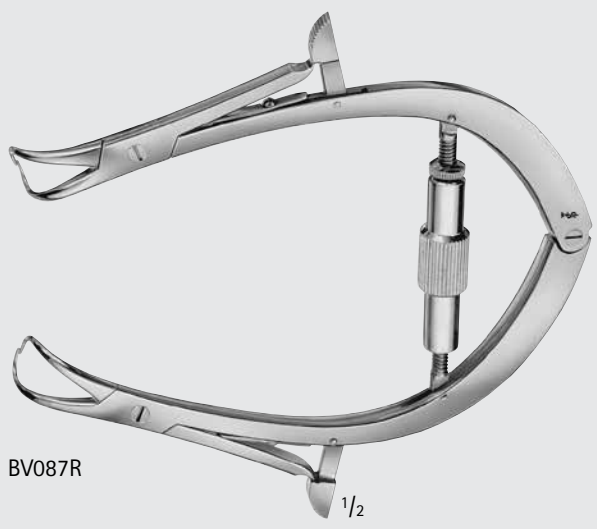

The image shows a JOLL (FRIEDMANN) Thyroid/Vaginal Retractor (BV087R). It is a large, C-shaped retractor with two curved arms and a central adjustment mechanism. The arms have serrated ends. A dimension of 1/2 is indicated near the bottom arm.

JOLL (FRIEDMANN) Thyroid/Vaginal Retractor

Catalog Number	Length (in.)
BV087R	6 1/8

BV087R

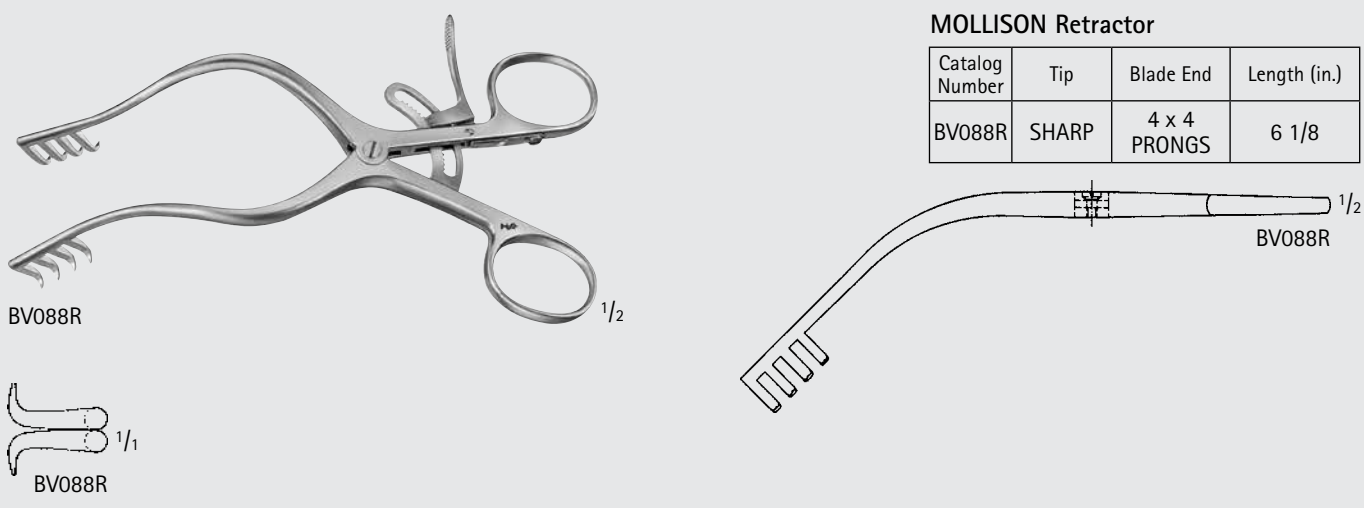

The image shows a MOLLISON Retractor (BV088R) in two views. The main view is a perspective drawing of the retractor, which has two long, curved arms with serrated ends and a central handle. A dimension of 1/2 is indicated near the handle. To the right, a smaller detail drawing shows the curved end of the arm with a dimension of 1/2.

MOLLISON Retractor

Catalog Number	Tip	Blade End	Length (in.)
BV088R	SHARP	4 x 4 PRONGS	6 1/8

BV088R

BV088R

General Surgery

Self Retaining Retractors

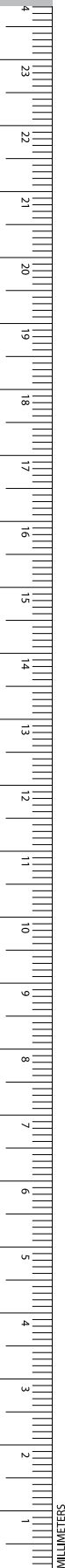

MAYO-ADAMS Retractor

Catalog Number	Length (in.)
BV112R	6 1/2

BV112R ^{1/2}

BV112R ^{1/1}

WILSTE-GELPI Retractor

Catalog Number	Tip	Tip Size (mm)	Length (in.)
MB929R	SHARP	70	11

MB929R ^{1/2}

MB929R ^{1/1}

GELPI Perineal Retractor

Catalog Number	Tip	Length (in.)
MB199R	SHARP WITH BALL STOPS	7

MB199R ^{1/2}

MB199R ^{1/1}

General Surgery

Self Retaining Retractors

GENERAL SURGERY

GELPI Vaginal Retractor

Catalog Number	Tip	Length (in.)
MG176R	SHARP	3 1/2
BV996R	SHARP	5 1/4
BV997R	SHARP	6 7/8
MD651	SHARP	7 1/4
MG177R	BLUNT	4 1/2

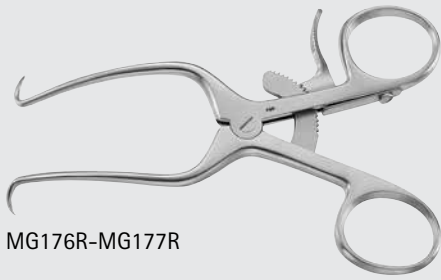

MG176R-MG177R



MG176R



MG177R



BV996R

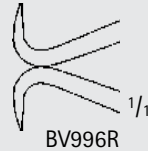

BV996R

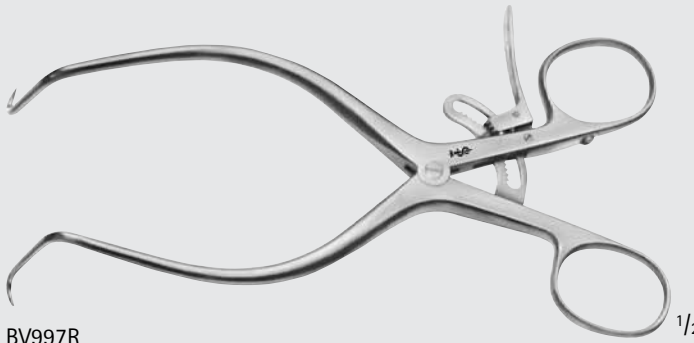

BV997R

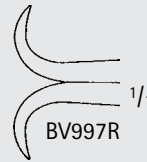

BV997R

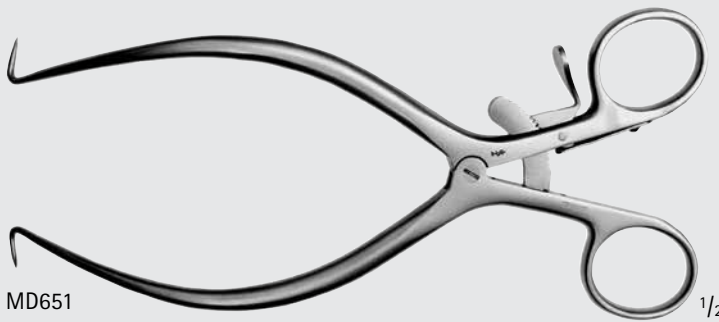

MD651

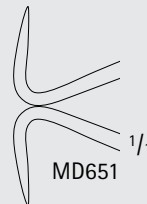

MD651



INCHES

General Surgery

Self Retaining Retractors



BV998R

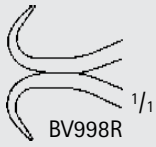

BV998R

DEBAKEY Femur Retractor for Children

Catalog Number	Tip	Length (in.)
BV998R	SHARP	4

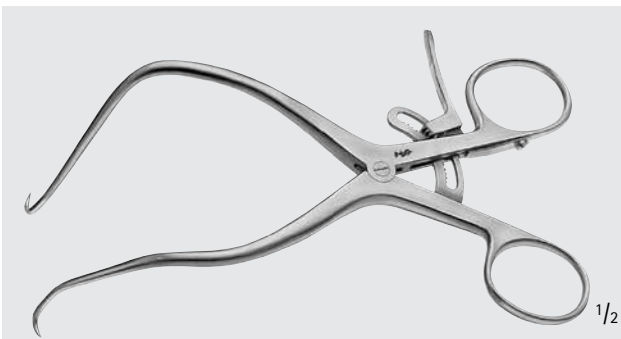

BV999R

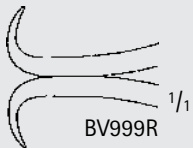

BV999R

DEBAKEY Femur Retractor for Adults

Catalog Number	Tip	Length (in.)
BV999R	SHARP	5 1/2

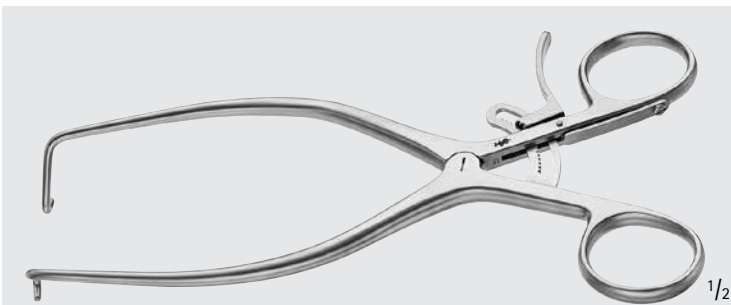

BV993R

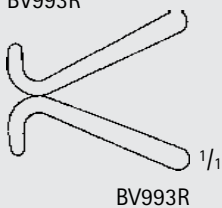

BV993R

JACKSON-BURROWS Retractor

Catalog Number	Tip	Length (in.)
BV993R	BLUNT	7

General Surgery

Self Retaining Retractors

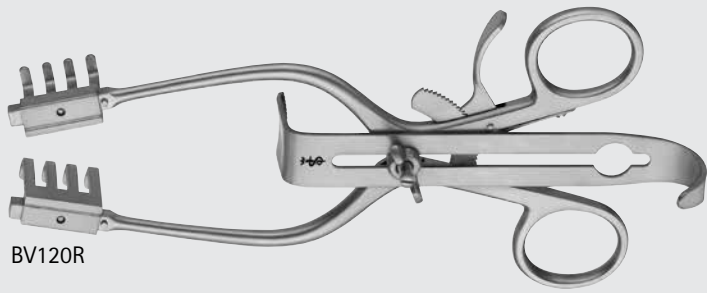

BV120R

HENLY Retractor

Catalog Number	Description	Blade Size (mm)	Blade Size (in.)	Length (in.)
BV120R	COMPLETE SET	-	-	7
MB842R	CENTER BLADE, SMALL	19 x 16	3/4 x 5/8	-
MB843R	CENTER BLADE, MEDIUM	25 x 16	1 x 5/8	-
MB844R	CENTER BLADE, LARGE	32 x 16	1 1/4 x 5/8	-
MB848R	CENTER BLADE, X-LARGE	76 x 16	3 x 5/8	-
MB845R	SIDE BLADE, PAIR (4 PRONGS)	25 x 25	1 x 1	-
MB846R	SIDE BLADE, PAIR (4 PRONGS)	51 x 25	2 x 1	-
MB847R	SIDE BLADE, PAIR (4 PRONGS)	76 x 22	3 x 1	-
MB849R	FRAME ONLY	-	-	7

BV120R Complete Set Includes:

- 1 Frame,
- 1 each of 4 Center Blades,
- 1 Pair of each of 3 Side Blades

Materials in set sold separately: MB842R-MB849R

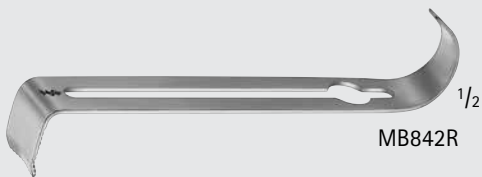

MB842R 1/2

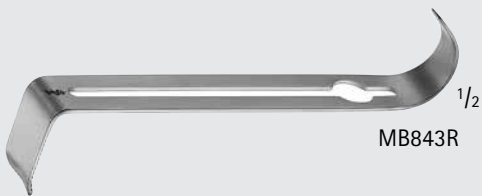

MB843R 1/2

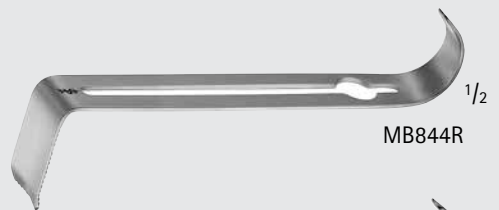

MB844R 1/2



MB848R 1/2



MB845R 1/2



MB846R 1/2



MB847R 1/2

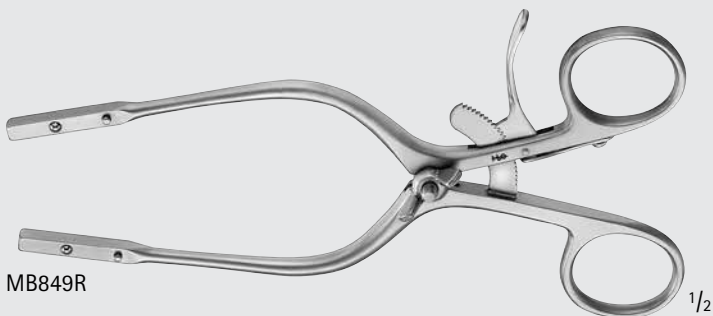

MB849R 1/2



INCHES

General Surgery

Rectal Specula Instruments

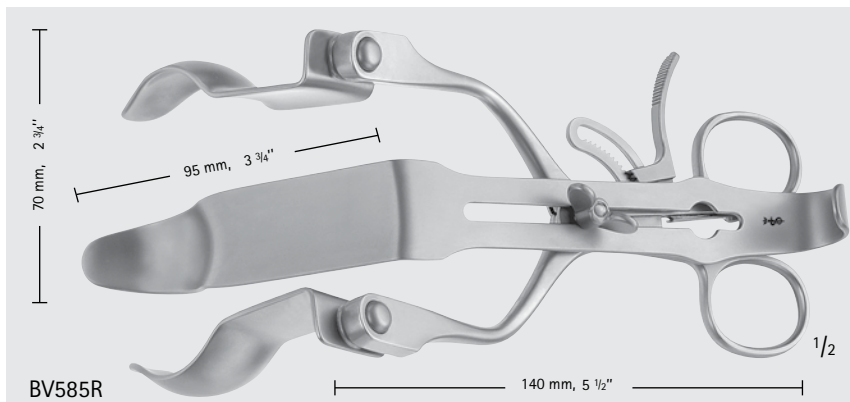

BV585R

PARKS Rectal Spreader

Catalog Number	Item	Length (mm)
BV585R	COMPLETE SET	-
BV581R	SPREADER ONLY	-
BV582R	CENTER BLADE	-
BV583R	SIDE BLADE, PAIR	70
BV586R	SIDE BLADE, PAIR	90
BV584R	SIDE BLADE, PAIR	93
BV589R	SIDE BLADE, PAIR	150

Set Includes:

- 1 Spreader BV581R
- 1 Center Blade BV582R
- 2 Blades of each BV583R and BV584R

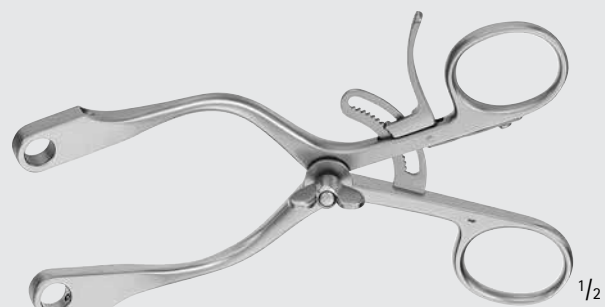

BV581R

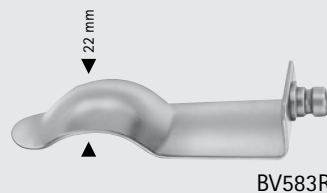

BV583R

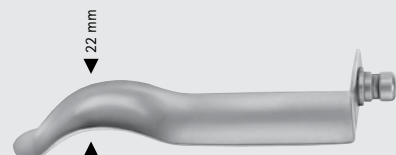

BV586R

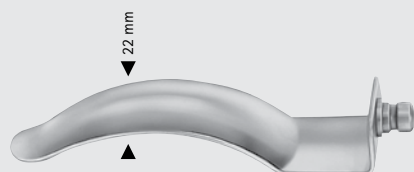

BV584R



BV589R

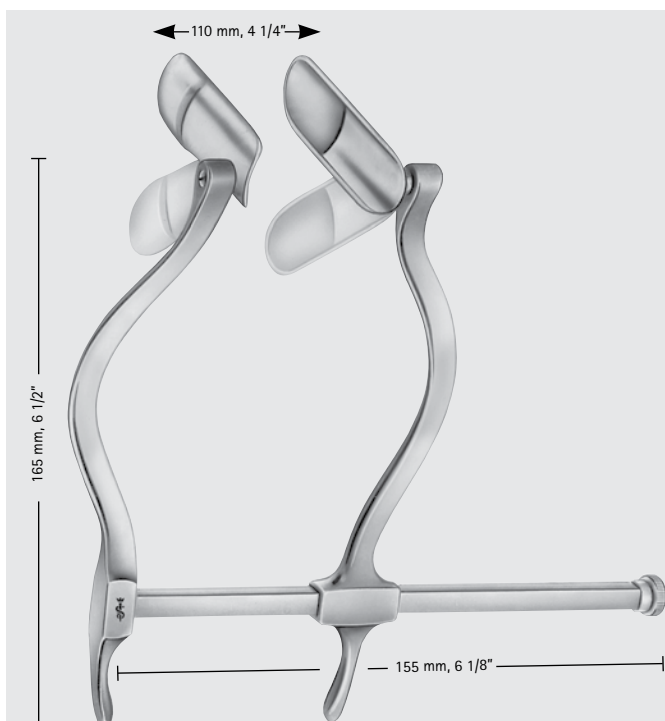

BV906R

SMITH-BUIE Rectal Retractor

Catalog Number	Blade Size (mm)
BV906R	58 x 23

General Surgery

Rectal Specula Instruments

ST. MARKS MODIFIED GIRONA Perineal Retractor

Catalog Number
BV907R

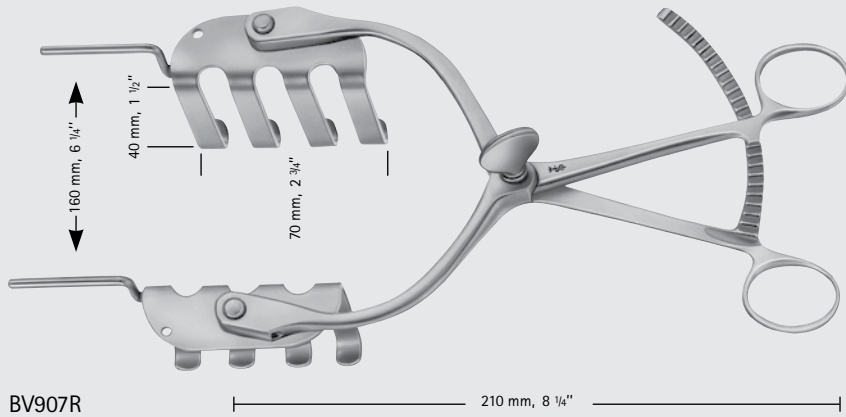

CZERNY Rectal Speculum

Catalog Number	Length (in.)
EA800R	8 7/8

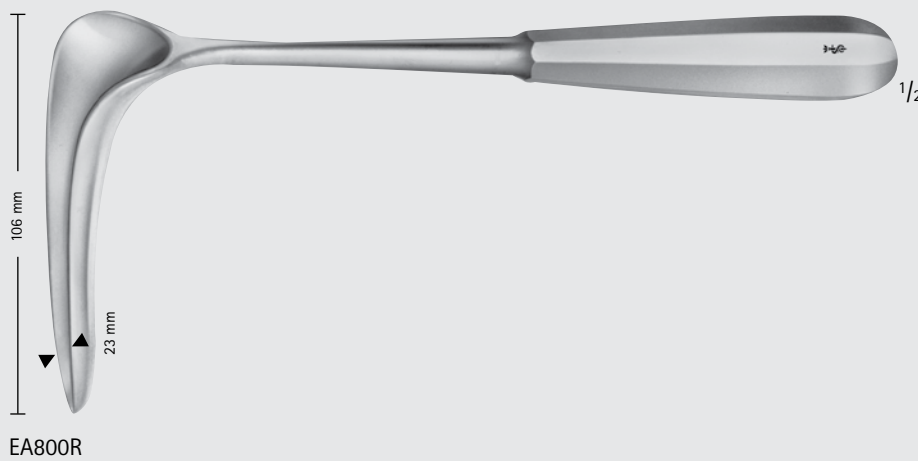

SAWYER Retractor

Catalog Number	Size	Blade Size (mm)	Length (in.)
MB773R	SMALL	70 x 19	10 3/4
MB772R	MEDIUM	82 x 29	10 3/4
MG178R	LARGE	97 x 38	11 5/8



MB772R-MG178R



INCHES

General Surgery

Rectal Specula Instruments

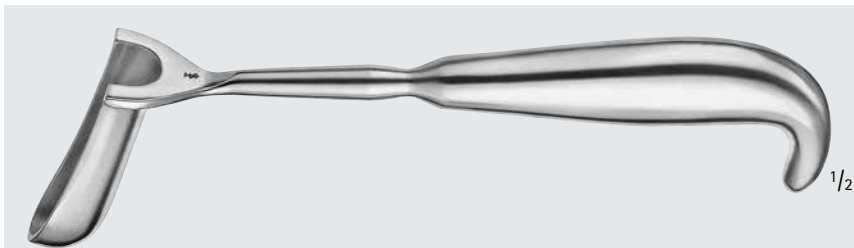

MB774R-MB776R

HILL-FERGUSSON Rectal Retractor

Catalog Number	Blade Size (mm)	Length (in.)
MB775R	64 x 24	8 1/4
MB774R	76 x 35	8 1/4
MB776R	76 x 32	8 1/4



EA820R

SIMS Rectal Speculum

Catalog Number	Blade	Length (in.)
EA820R	SOLID	6 1/4
EA821R	FENESTRATED	6 1/4



EA821R

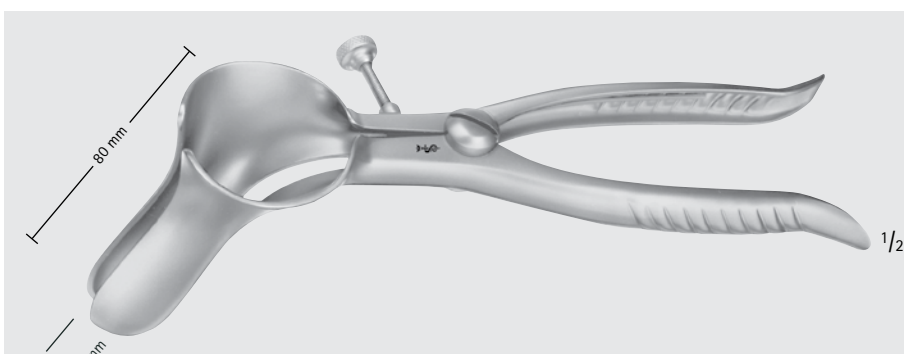

EA831R

PRATT Rectal Speculum

Catalog Number	Length (in.)
EA831R	8

General Surgery

Rectal Specula Instruments

MATHIEU Rectal Speculum

Catalog Number	Length (in.)
EA843R	8 1/2

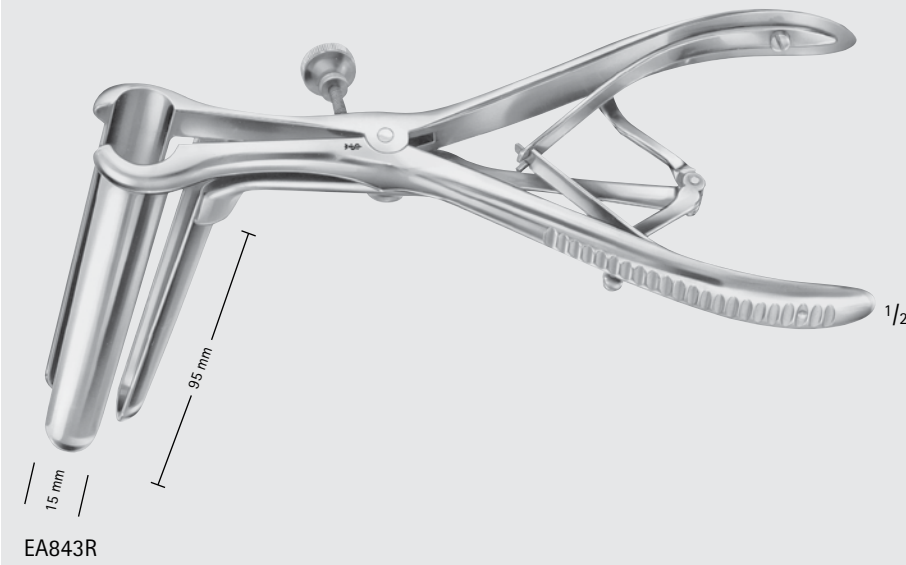

IVES-FANSLER Anuscope

Catalog Number	Length (in.)
EA880R	5 3/4



Rectal Speculum

Catalog Number	Length (in.)
MB274R	2 3/8



INCHES

General Surgery

Rectal Specula Instruments

GENERAL SURGERY

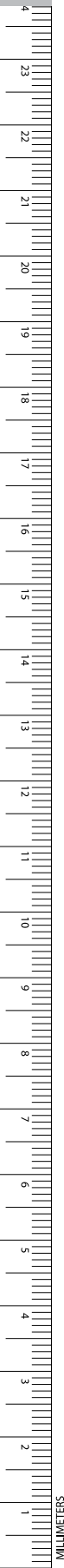

MG160R

CHELSEA-EATON Anal Speculum

Catalog Number	Size	Diameter (mm)	Finish	Length (in.)
MG160R	SMALL	30	MIRROR FINISH	2 1/2



MB179R, MB203R, MB288R

HIRSCHMANN Rectal Speculum

Catalog Number	Size	Blade Size (mm)
MB203R	SMALL	60 x 16
MB288R	MEDIUM	72 x 19
MB179R	LARGE	89 x 23

General Surgery

Rectal Specula Instruments

BRINKERHOFF Rectal Speculum

Catalog Number	Size	Diameter (in.)	Length (in.)
MG162R	SMALL	1/2 x 1	3 3/4
MG163R	MEDIUM	5/8 x 1	3 3/4
MB284R	LARGE	3/4 x 1 1/4	4 1/2



MB284R, MG162R-MG163R

KELLY Sphincteroscope

Catalog Number	Diameter (mm)	Working Length (mm)	Length (in.)
EA882R	21	54	6 1/4
EA887R	22	140	5 1/2
EA883R	25	50	6 1/4



EA882R-EA887R

General Surgery

Rectal Specula Instruments

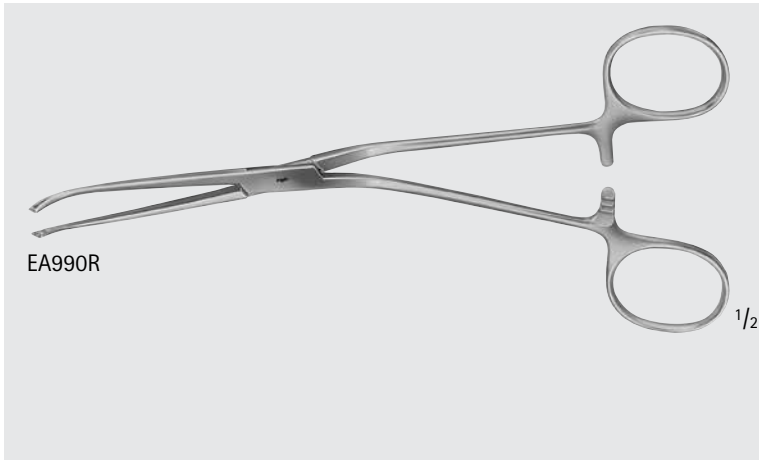

MCGIVNEY Hemorrhoidal Forceps

Catalog Number	Length (in.)
EA990R	7 1/4

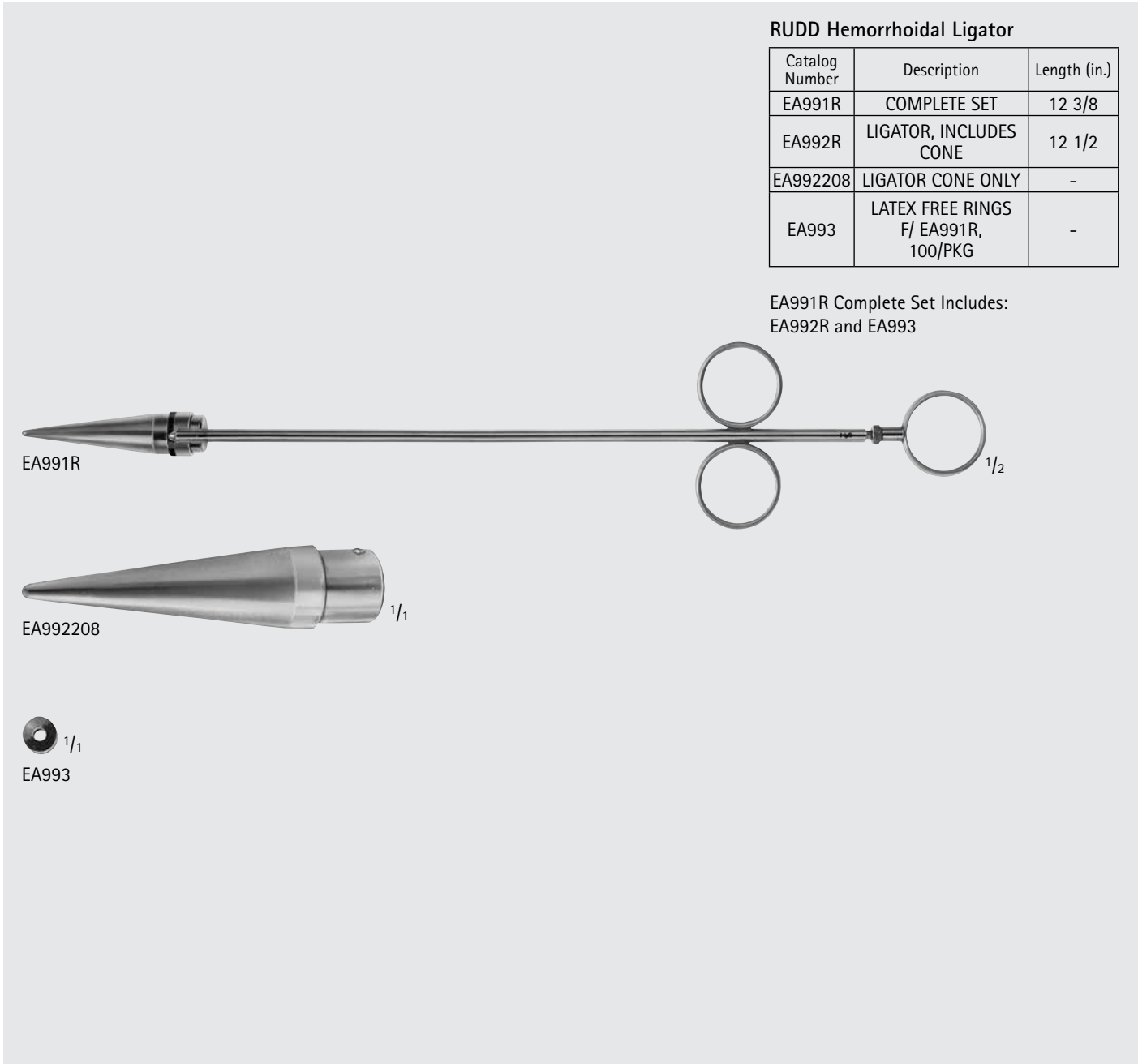

RUDD Hemorrhoidal Ligator

Catalog Number	Description	Length (in.)
EA991R	COMPLETE SET	12 3/8
EA992R	LIGATOR, INCLUDES CONE	12 1/2
EA992208	LIGATOR CONE ONLY	-
EA993	LATEX FREE RINGS F/ EA991R, 100/PKG	-

EA991R Complete Set Includes:
EA992R and EA993

General Surgery
Rectal Specula Instruments



MB892R

STEWART Crypt Hook

Catalog Number	Length (in.)
MB892R	9



MB892R



General Surgery

Probes, Dilators and Scoops



BAKES Bile-Duct Dilator

Catalog Number	Tip Size (mm)	Length (in.)
EB061R	1	12 3/8
EB062R	2	12 3/8
EB063R	3	12 3/8
EB064R	4	12 3/8
EB065R	5	12 3/8
EB066R	6	12 1/2
EB067R	7	12 1/2
EB068R	8	12 1/2
EB069R	9	12 1/2
EB070R	10	12 1/2
EB071R	11	12 1/2
EB072R	12	12 1/2
EB073R	13	12 1/2
EB074R	SET, 3-11 mm	-



EB061R-EB074R

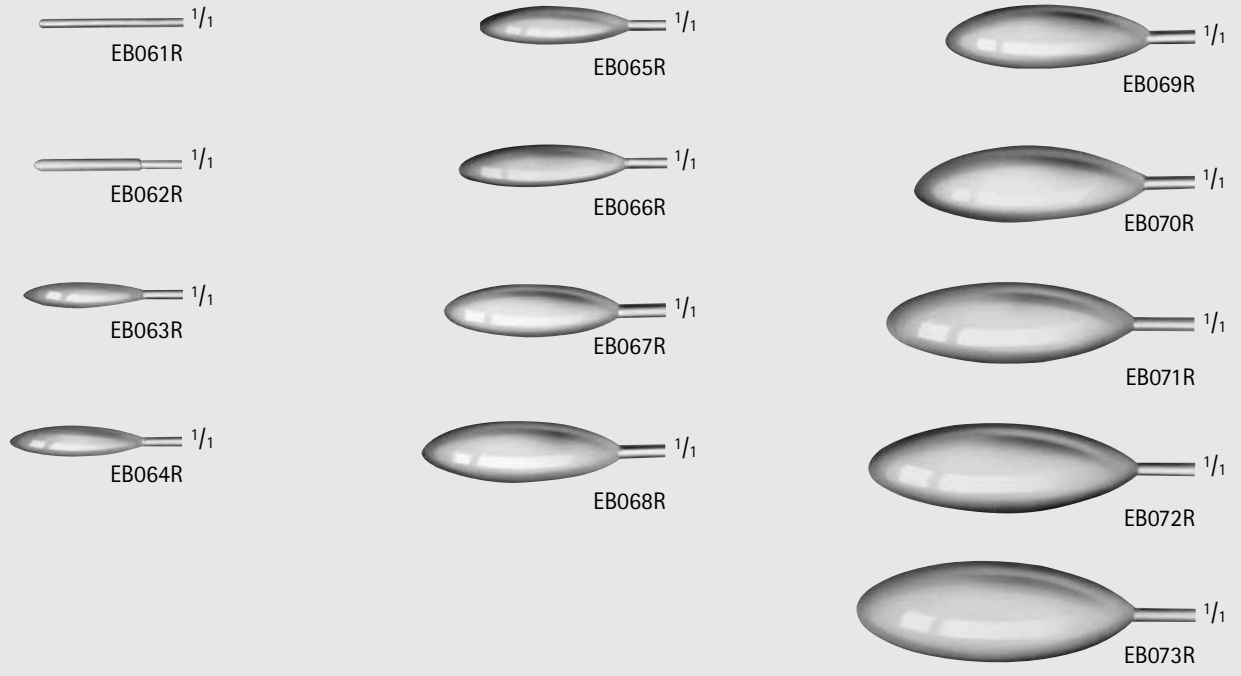

EB061R 1/1

EB065R 1/1

EB069R 1/1

EB062R 1/1

EB066R 1/1

EB070R 1/1

EB063R 1/1

EB067R 1/1

EB071R 1/1

EB064R 1/1

EB068R 1/1

EB072R 1/1

EB073R 1/1

LUER-KOERTE Scoops, Malleable Shaft

Catalog Number	Tip Size (mm)	Length (in.)
EB168R	2.8	12 3/4
EB169R	3.4	12 3/4
EB170R	4.3	12 3/4
EB171R	5.5	12 3/4
EB172R	6.7	12 3/4
EB173R	8.0	12 3/4
EB174R	11.0	12 3/4
EB175R	15.0	12 3/4



EB168R-EB175R

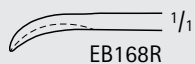

EB168R

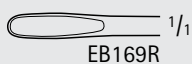

EB169R



EB170R

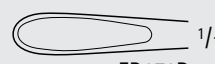

EB171R



EB172R

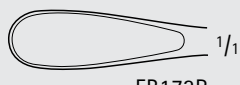

EB173R



EB174R



EB175R



BN003R-BN006R



BN003R-BN006R

Director W/ Tongue

Catalog Number	Blade Shape	Length (in.)
BN003R	STR	5 1/8
BN004R	STR	5 3/4
BN006R	STR	6 1/4



BN010R

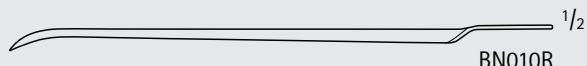

BN010R

DOYEN Director W/ Tongue

Catalog Number	Blade Shape	Length (in.)
BN010R	CVD	5 3/4



INCHES

General Surgery

Probes, Dilators and Scoops



MB336R

Grooved Director W/ Tongue

Catalog Number	Length (in.)
MB336R	4 1/2

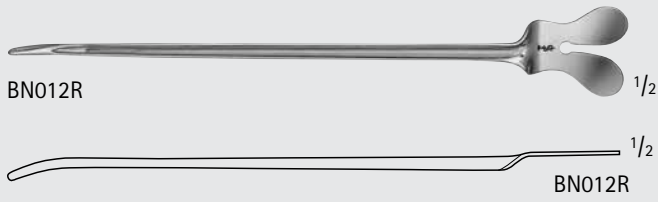

BN012R

NELATON Director

Catalog Number	Blade Shape	Length (in.)
BN012R	CVD	6 1/4

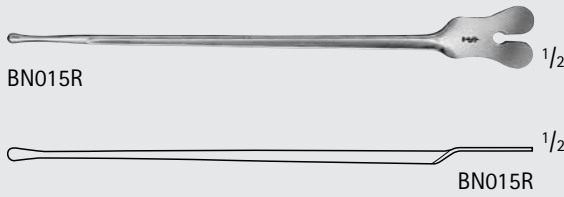

BN015R

Director, W/ Probe Tip & Tongue

Catalog Number	Diam. of Tip (mm)	Blade Shape	Length (in.)
BN015R	3.3	STR	5 1/2

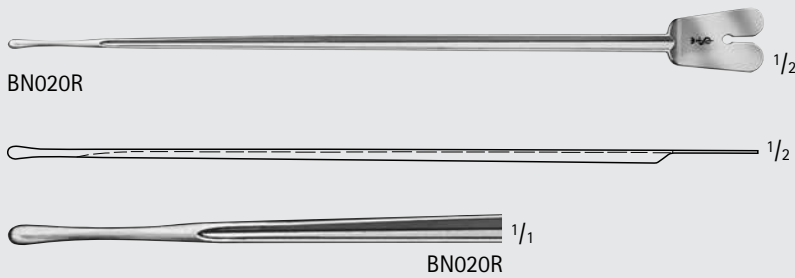

BN020R

BRODIE Director, W/ Probe Tip & Tongue

Catalog Number	Diam. of Tip (mm)	Blade Shape	Length (in.)
BN020R	3.5	STR	7 7/8

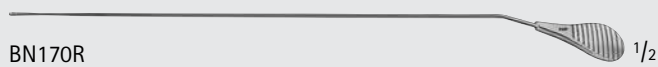

BN170R

Probe

Catalog Number	Diam. of Tip (mm)	Length (in.)
BN170R	1.4	6 1/4

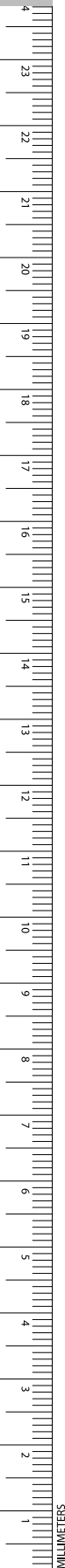

LOCKHART-MUMMERY Fistula Probe

Catalog Number	Blade Shape	Length (in.)
BN021R	#1-STR	6 1/2
BN022R	#2-SLT-CVD	6 1/2
BN023R	#3-CVD	6 1/2
BN024R	#4-HVY-CVD	6 1/2

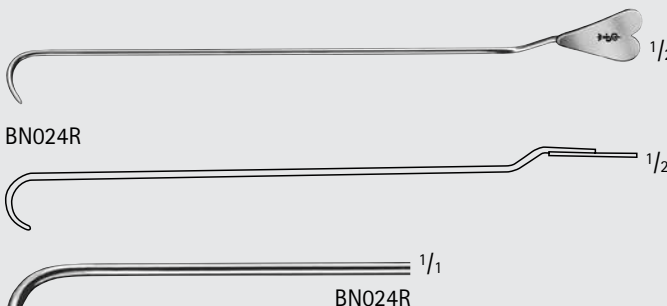
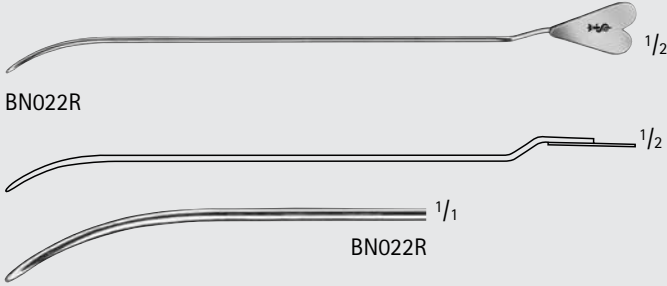
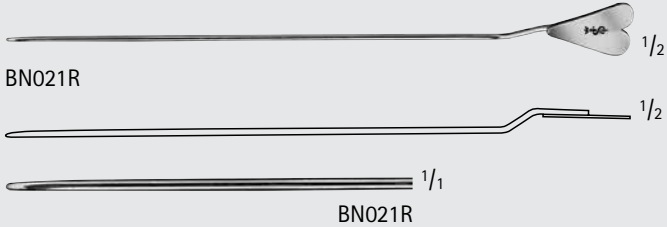

General Surgery

Probes, Dilators and Scoops

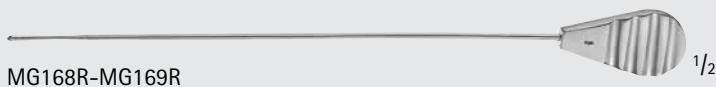

MG168R-MG169R

BUIE Fistula Probe

Catalog Number	Description	Length (in.)
MG168R	LIGHT	6 1/2
MG169R	HEAVY	6 1/2



BN034R-BN040R, MB603R

Probe W/ Eye

Catalog Number	Tip Size (mm)	Length (in.)
MB603R	1.5	5
BN034R	2.5	5 3/4
BN036R	2.5	6 1/4
BN040R	3	7 7/8



MG571

Probe W/ Eye, Silver

Catalog Number	Tip Size (mm)	Length (in.)
MG571	1.75	4 1/2



BN054R



BN063R-BN070R

Myrtle Leaf Probe

Catalog Number	Tip Size (mm)	Length (in.)
BN054R	1.5	5 3/4
BN063R	2	5 1/8
BN064R	2	5 3/4
BN066R	2	6 1/4
BN068R	2	7
BN070R	2	7 7/8

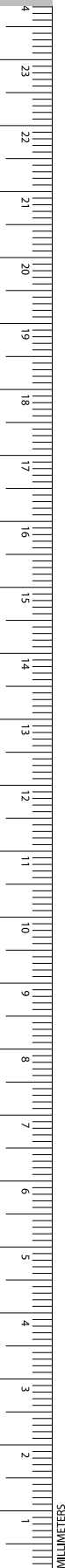

BN104R-BN150R



Double Ended Probe

Catalog Number	Tip Size (mm)	Length (in.)
BN104R	1.0	5 3/4
BN113R	1.5	5 1/8
BN114R	1.5	5 3/4
BN116R	1.5	6 1/4
BN118R	1.5	7
BN120R	1.5	7 7/8
BN125R	1.5	9 3/4
BN134R	2.0	5 3/4
BN136R	2.0	6 1/4
BN138R	2.0	7
BN140R	2.0	7 7/8
BN150R	2.0	11 3/4

BN090R

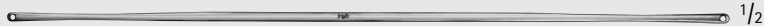

Double Ended Probe W/ Eye, Malleable

Catalog Number	Tip Size (mm)	Length (in.)
BN090R	3.0	7 1/2
BN095	3.5	9 3/4
BN096	3.5	11 3/4

BN095-BN096



PRATT Rectal Probe, Malleable

Catalog Number	Tip Size (mm)	Length (in.)
MB486	2.0	10

MB486

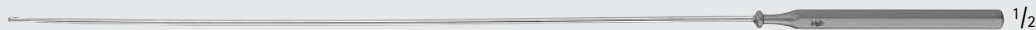

Probe

Catalog Number	Tip Size (mm)	Length (in.)
BN101R	2.0	11 3/4

BN101R

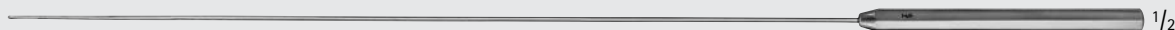

General Surgery

Probes, Dilators and Scoops



FERGUSSON Gall Stone Scoop, Double Ended

Catalog Number	Size	Length (in.)
MB697R	SMALL	9 1/2
MB698R	MEDIUM	9 1/2
MB699R	LARGE	9 1/2



MB697R-MB699R



MB697R-MB699R

BARR Fistula Probe, Double Ended

Catalog Number	Length (in.)
MG170R	6 5/8



MG170R

PRATT Fistula Probe, Crypt Hook

Catalog Number	Length (in.)
EA890R	9 1/2



EA890R



ROSSER Crypt Hook

Catalog Number	Length (in.)
MG165R	6 5/8

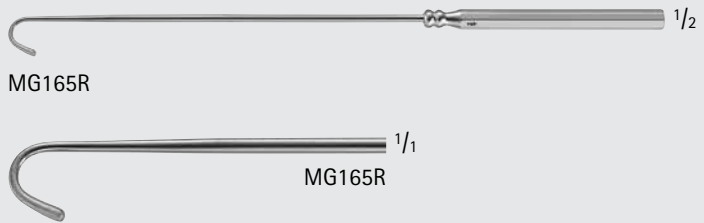

DESJARDINS Gall Duct Probe, Flexible

Catalog Number	Tip Size (mm)	Length (in.)
EB101R	3.8	11 1/4
EB102R	4.3	11 1/4
EB103R	6.8	11 1/4

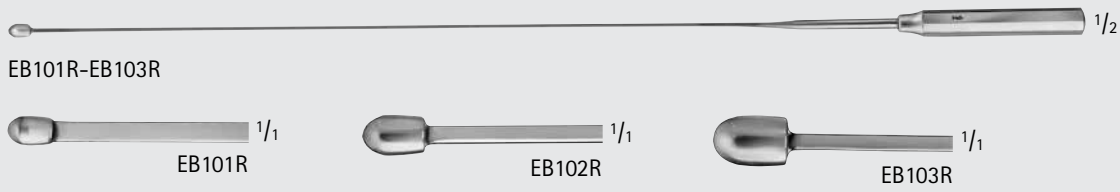

DESJARDINS Gall Stone Scoop

Catalog Number	Tip Size (mm)	Length (in.)
EB111R	6	11 3/4
EB112R	7	11 3/4
EB113R	8	11 3/4
EB114R	9	11 3/4

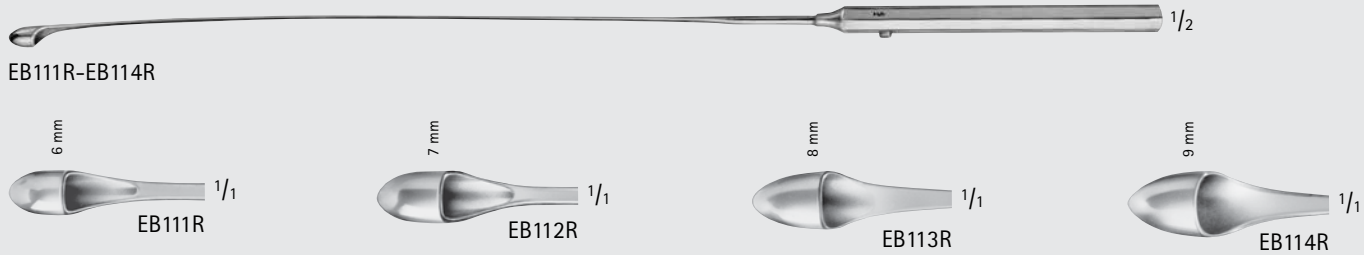

MAYO Gall Duct Probe

Catalog Number	Tip Size (mm)	Tip	Length (in.)
E0005R	5	MALLEABLE	13



General Surgery

Scalpel Handles



Micro Scalpel Handle

Catalog Number	Size	Length (in.)	Handle
MB104R	3H	4	Hexagonal
MB141R	3HL	6	Hexagonal
MB280R	3KM	3	Round Knurled
MB997R	3K	4	Round Knurled
MB281R	3KD	5	Round Knurled
BB046R	3K	5 1/4	Round Knurled
MB271R	3KL	6	Round Knurled
BB048R	3KL	6 1/8	Round Knurled
MG221R	3	7	Round Knurled
BB054R	3	7 7/8	Round Knurled
MG222R	3	8	Round Knurled
BB060R	3	17 3/4	Round Knurled
MB475R	COLLET		



MB104R



MB141R



MB280R



MB997R



MB281R



BB046R



MB271R



BB048R

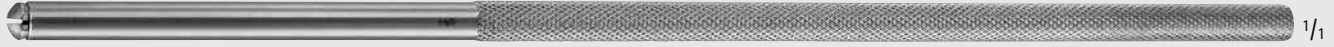

MG221R



BB054R



MG222R



BB060R



MB475R

MB475R

Replacement collet for MB104R, MB141R, MB271R, MB280R, MB281R and MB997R

CORWIN Knife Handle

Catalog Number	Length (in.)
MA203R	5 1/2



MA203R

CASPAR Scalpel Handle

Catalog Number	Length (in.)
BB052R	7



BB052R

LANDOLT Scalpel Handle,
F/ Microsurgery Blades

Catalog Number	Length (in.)
BB053R	8 1/4
BB057R	9 3/4



BB053R



1/1



1/1

BB053R

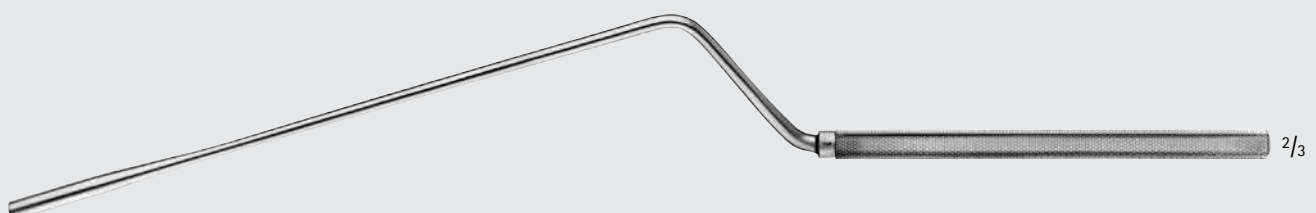

BB057R

YASARGIL Arachnoid Blades
F/ LANDOLT Scalpel Handles

Catalog Number	Tip Size (mm)	Packaging
BB331R	1.5	10/BOX
BB332R	2.5	10/BOX



BB331R



BB332R



INCHES

General Surgery

Scalpel Handles



Transsphenoidal Scalpel Handle, Bayonet, F/ Vertical and Lateral Blades

Catalog Number	Length (in.)
BB071R	8 1/4

BB071R 2/3

BB071R 1/1

Sterile Microsurgery Blades

Catalog Number	Tip	Packaging
BB361R	SMALL CHISEL #61	10/BOX
BB362R	WIDE CHISEL #62	10/BOX
BB363R	SPEAR #63	1 EACH
BB364R	ROUND #64	10/BOX
BB365R	SMALL, SHARP #65	10/BOX
BB367R	CURVED, POINTED #67	10/BOX
BB368R	SMALL SICKLE #68	10/BOX

BB361R 1/1

BB362R 1/1

BB363R 1/1

BB364R 1/1

BB365R 1/1

BB367R 1/1

BB368R 1/1

BARRON Scalpel Handle #3 F/ Blades nos. 10-15, 40, 42

Catalog Number	Length (in.)
BB068R	5 1/8

BB068R 1/1

Scalpel Handle #3, F/ Blades nos. 10-15, 40, 42

Catalog Number	Length (in.)
BB070R	6 1/8

BB070R 1/1

General Surgery

Scalpel Handles

Scalpel Handle #3, F/ Blades nos. 10-15, 40, 42

Catalog Number	Size	Length (in.)
BB074R	#3	5
BB075R	#3L	8 1/4
BB175R	#3XL	9 3/4
MB917R	#3	16



Scalpel Handle #3L, F/ Blades nos. 10-15, 40, 42

Catalog Number	Blade Shape	Length (in.)
MB127R	ANG	8



Scalpel X-Long Handle, #3, F/ Blades nos. 10-15, 40, 42

Catalog Number	Blade Shape	Length (in.)
BB078R	STR	8 7/8



General Surgery

Scalpel Handles



BB079R

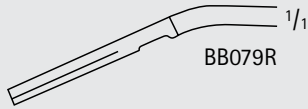

BB079R

Scalpel X-Long Handle, #3, F/ Blades nos. 10-15, 40, 42

Catalog Number	Blade Shape	Length (in.)
BB079R	ANG	8 7/8



BB080R

Scalpel Handle #4, F/ Blade nos. 18-36

Catalog Number	Length (in.)
BB080R	8 7/8

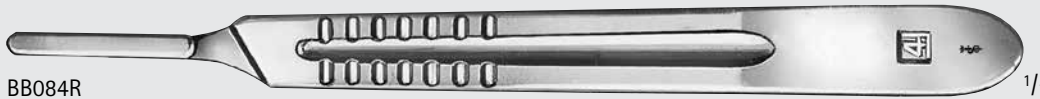

BB084R

Scalpel Handle #4, F/ Blades nos. 18-36

Catalog Number	Length (in.)
BB084R	5 1/4



BB085R

Scalpel Handle #4L, F/ Blades nos. 18-36

Catalog Number	Length (in.)
BB085R	8 1/2

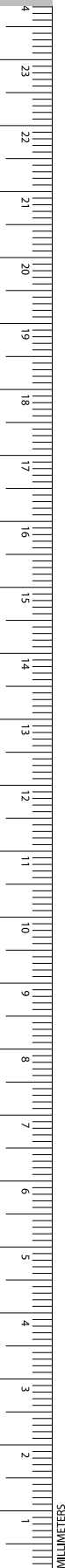

Scalpel Handle #4XL, F/ Blades nos. 18-36

Catalog Number	Length (in.)
BB087R	9 3/4



BB087R

2/3

Scalpel Handle #7, F/ Blades nos. 10-15, 40, 42

Catalog Number	Length (in.)
BB077R	6 1/4



BB077R

1/1

Scalpel Handle #9XL, F/ Blades nos. 18-36

Catalog Number	Length (in.)
MA202R	4 5/8
BB089R	5 3/4



MA202R

1/1



BB089R

1/1



INCHES

General Surgery

Scalpel Blades



BB510, 16600495



BB515, 16600525



BB511, 16600509



BB540 double cutting



BB512, 16600517



BB542 double cutting

Sterile Scalpel Blade, For #3 Handle

Catalog Number		Blade Number	Packaging
Carbon	Stainless Steel		
BB510	16600495	#10	100/BOX
BB511	16600509	#11	100/BOX
BB512	16600517	#12	100/BOX
BB515	16600525	#15	100/BOX
BB540	-	#40	100/BOX
BB542	-	#42	100/BOX



BB520, 16600550



BB521, 16600568



BB522, 16600576



BB523, 16600584



BB524, 16600592



BB525, 16616634



BB536, 16615522

Sterile Scalpel Blade, For #4 Handle

Catalog Number		Blade Number	Packaging
Carbon	Stainless Steel		
BB520	16600550	#20	100/BOX
BB521	16600568	#21	100/BOX
BB522	16600576	#22	100/BOX
BB523	16600584	#23	100/BOX
BB524	16600592	#24	100/BOX
BB525	16616634	#25	100/BOX
BB536	16615522	#36	100/BOX



BB500, 16600487

Sterile Stitch Cutter Blade #3 Handle

Catalog Number		Packaging
Carbon	Stainless Steel	
BB500	16600487	100/BOX

GENERAL SURGERY

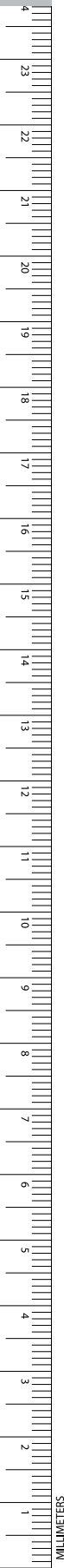

General Surgery

Sterile Scalpels With Plastic Handle

GENERAL SURGERY

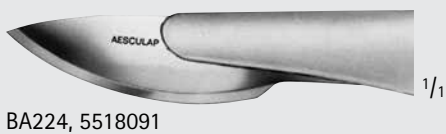
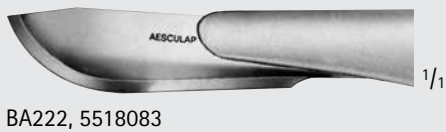
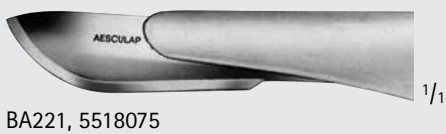

Sterile Scalpels W/ Plastic Handle and Blade Protector

Carbon	Catalog Number		Size	Packaging
	Carbon	Stainless Steel		
	BA210	5518059	10	10/BOX
	BA211	5518040	11	10/BOX
	BA212	5518105	12	10/BOX
	BA215	5518032	15	10/BOX
	BA218	-	18	10/BOX
	BA219	-	19	10/BOX
	BA220	5518067	20	10/BOX
	BA221	5518075	21	10/BOX
	BA222	5518083	22	10/BOX
	BA223	5518016	23	10/BOX
	BA224	5518091	24	10/BOX



General Surgery

Amputation and Autopsy Instruments



LISTON Amputating Knife

Catalog Number	Blade Length (mm)	Blade Size (in.)
FH100R	130	5 1/8
FH101R	160	6 1/4
FH102R	190	7 1/2
FH103R	220	8 3/4



FH100R-FH103R

CATLIN Amputating Knife, Double Cutting

Catalog Number	Blade Length (mm)	Blade Size (in.)
FH116R	160	6 1/4



FH116R

1/2

General Surgery

Amputation and Autopsy Instruments



CHARRIÈRE Amputation Saw, 2 Blades

Catalog Number	Item	Blade Size (in.)	Blade Width (mm)	Total Length (in.)
FH300R	SAW COMPLETE W/2 BLADES	8 1/2	-	14
FH301C	CARBON STEEL BLADE	8 1/2	12	-
FH302C	CARBON STEEL BLADE	8 1/2	18	-



FH300R



FH301C-FH302C

CHARRIÈRE Amputation Saw

Catalog Number	Item	Blade Size (in.)	Total Length (in.)
FH320R	SAW COMPLETE	7 1/4	10 1/2



FH320R

SATTERLEE Amputation Saw

Catalog Number	Item	Total Length (in.)
FH325R	SAW COMPLETE	11 1/2
FH326R	CARBON STEEL BLADE F/ FH325R	-

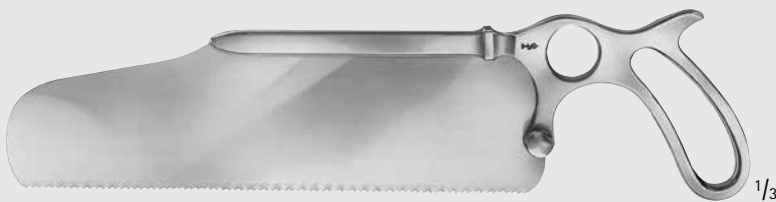

FH325R-FH326R

General Surgery

Amputation and Autopsy Instruments



LANGENBECK Metacarpal Saw

Catalog Number	Length (in.)
FH335R	9 1/4



FH335R

GIGLI Wire Saw

Catalog Number	Diameter (mm)	Wires	Sales Unit	Length (in.)
FH414	1.4	6	BOX OF 5	15 3/4
FH415	1.4	6	BOX OF 5	19 3/4
FH430R	1.8	4	BOX OF 5	19 3/4

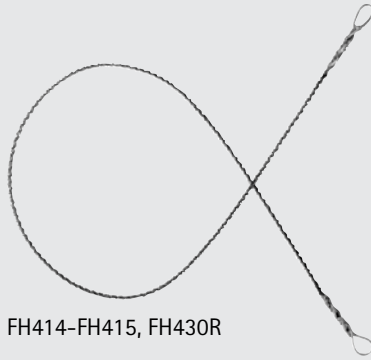

FH414-FH415, FH430R



FH414-FH415, FH430R

GIGLI Saw Handle

Catalog Number	Packaging
MB986R	2/SET



MB986R

GIGLI Hook Handle, F/ Wire Saws

Catalog Number	Packaging
FH480R	2/SET



FH480R

1/2

POOLE Suction Tube

Catalog Number	Handle	Tip Size (FR)	Hole in Tip Inner/Outer	Tube Diameter Inner/Outer	Length (in.)
MG272R	STR	30	YES/YES	5 mm/10 mm	8 1/2
GF862R	STR	30	YES/NO	5 mm/10 mm	8 7/8
MB927R	STR	30	YES/YES	4 mm/10 mm	14
MB928R	STR	30	YES/YES	4 mm/10 mm	16
MG271R	CVD	24	YES/NO	4 mm/8 mm	8 3/4
GF860R	CVD	21	YES/YES	4 mm/8 mm	8 7/8



MG272R



GF862R



MB927R-MB928R



MB927R



MB928R

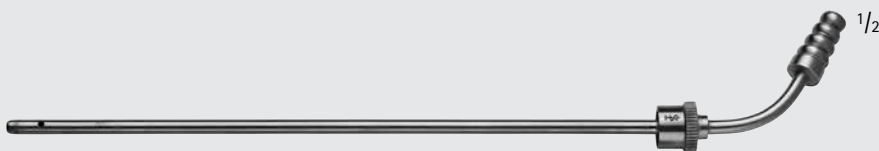

MG271R



GF860R



INCHES

General Surgery

Suction Tubes



Diam. 4 mm

Olive Diam. 9 mm

GF917R

ADSON Suction Tube

Catalog Number	Tip Size (mm)	Tip Size (FR)	Length (in.)
GF917R	4	11	7 1/2



Olive Diam. 6 - 9 mm

GF919R

Nasal Suction Tube W/ Luer Hub, Tapered

Catalog Number	Tip Size (mm)	Length (in.)
GF919R	5	7

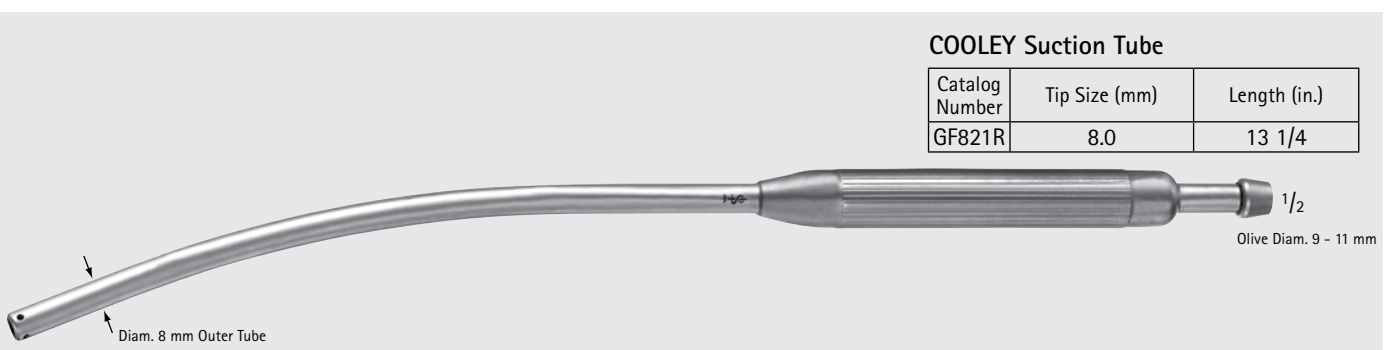

Diam. 8 mm Outer Tube

Olive Diam. 9 - 11 mm

GF821R

COOLEY Suction Tube

Catalog Number	Tip Size (mm)	Length (in.)
GF821R	8.0	13 1/4

COOLEY Suction Tube W/ Detachable Tip

Catalog Number	Tip Size (mm)	Shaft	Length (in.)
GF822R	8.0	SLT-CVD	12 1/4
GF823R	9.0	CVD	11 5/8
GF824R	8.0	ANG	12 1/2
GF825R	9.0	90°	10 1/2



GF822R



GF823R



GF824R

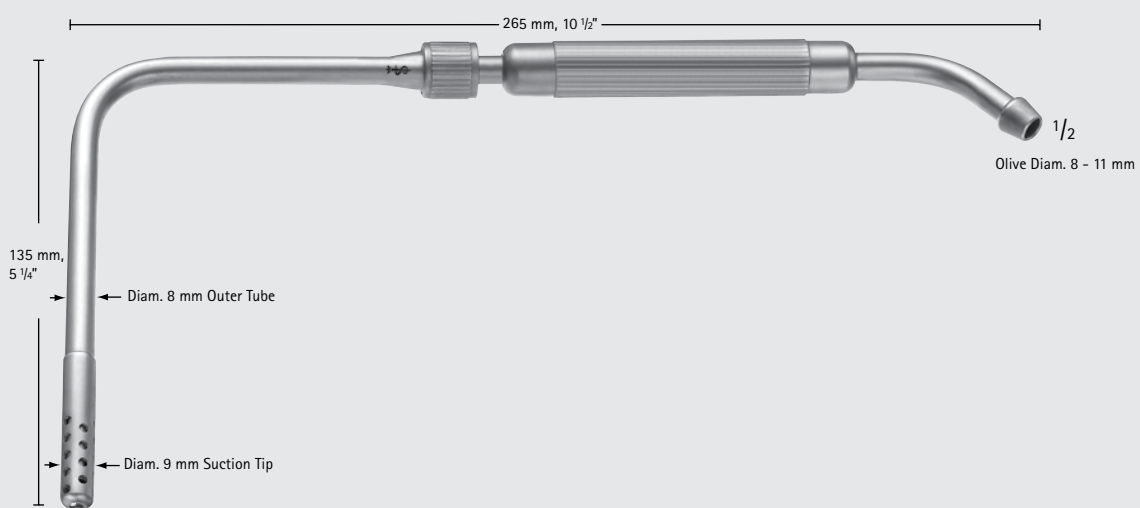

GF825R



INCHES

General Surgery

Suction Tubes

Grafting Suction Tube

Catalog Number	Tip Size (mm)	Length (in.)
MB286R	3	9 1/2
MB287R	4	9 1/2



MB286R-MB287R

DEBAKEY Suction Tube

Catalog Number	Tip Size (mm)	Length (in.)
GF946R	3	10 3/4
GF947R	5	6 1/4
GF948R	5	10 5/8
GF946205	REPLACEMENT TIP FOR GF946R	-



GF946R



Diam. 9 mm

GF946R



GF947R

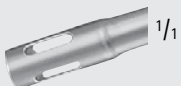

Diam. 5 mm

GF947R

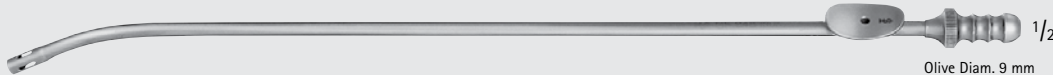

GF948R



Diam. 5 mm

GF948R

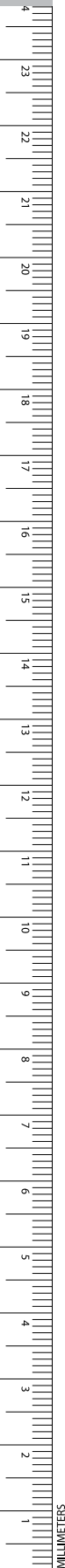

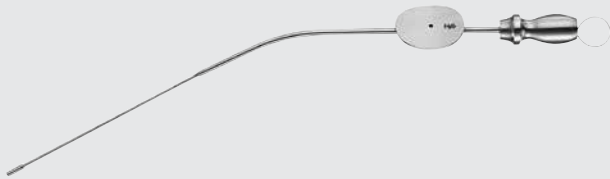

MF333R-MF347R

Atraumatic Suction Tube

Catalog Number	Tip Size (FR)	Working Length (in.)	Length (in.)
MF333R	3	3	6 1/4
MF334R	5	3	6 1/4
MF335R	7	3	6 1/4
MF336R	10	3	6 1/4
MF337R	12	3	6 1/4
MF338R	3	4	7 1/4
MF339R	5	4	7 1/4
MF340R	7	4	7 1/4
MF341R	10	4	7 1/4
MF342R	12	4	7 1/4
MF343R	3	5	8 1/4
MF344R	5	5	8 1/4
MF345R	7	5	8 1/4
MF346R	10	5	8 1/4
MF347R	12	5	8 1/4

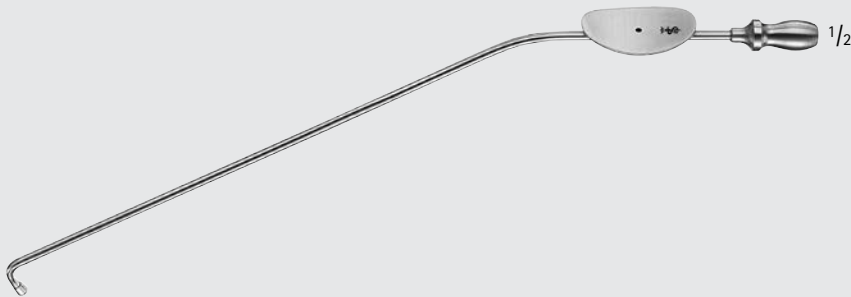

MF106R-MF111R



MF106R-MF108R



MF109R-MF111R

Atraumatic Suction Tube

Catalog Number	Tip	Tip Size (FR)	Length (in.)
MF106R	90° DOWN	5	8 1/2
MF107R	90° DOWN	7	8 1/2
MF108R	90° DOWN	10	8 1/2
MF109R	90° UP	5	8 1/2
MF110R	90° UP	7	8 1/2
MF111R	90° UP	10	8 1/2



INCHES

General Surgery

Suction Tubes

YANKAUER Suction Tube

Catalog Number	Description	Tip Opening (mm)	Length (in.)
GF944R	-	2.0	11 1/4
OM671R	-	4.8	11 1/4
MB919R	-	2.0	12
MG092R	W/ VALVE	2.0	13 1/4
MB051R	-	2.0	14
MB920R	W/ VALVE	2.0	16
GF944200	REPLACEMENT TIP F/ GF944R	-	-
OM671200	REPLACEMENT TIP F/ OM671R	-	-
MB051200	REPLACEMENT TIP F/ MB051R, MB053R, MG919R, MG920R	-	-
MG092200	REPLACEMENT TIP F/ MG092R	-	-

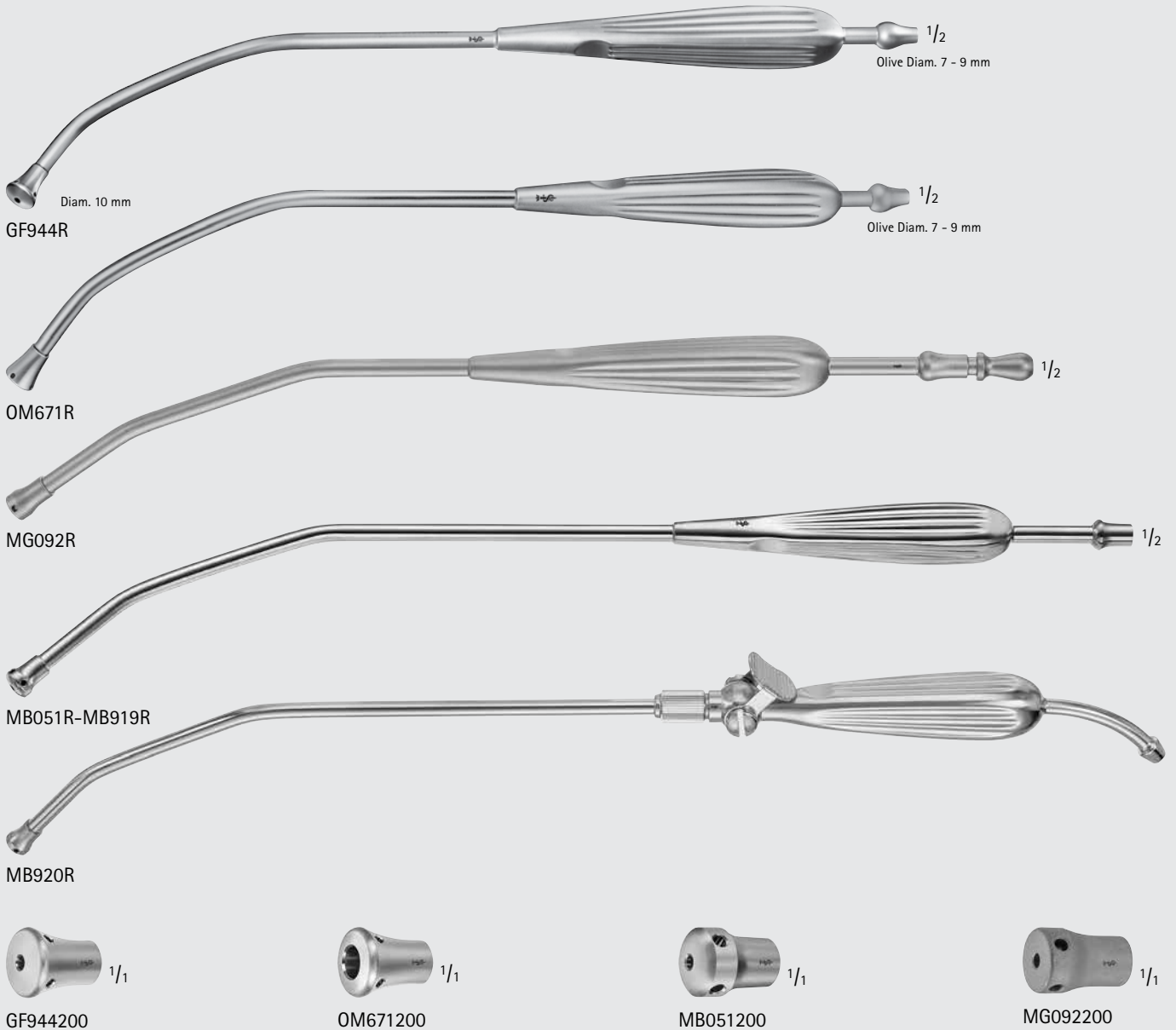

YANKAUER Suction W/ Thumb Control

Catalog Number	Description	Length (in.)
MB052R	HANDLE W/ THUMB CONTROL	6 7/8
MB053R	SUCTION TUBE, CHROME PLATED	6 5/8



MB052R



MB053R

FERGUSON Suction Tube

Catalog Number	Tip	Tip Size (mm)	Length (in.)
GF933R	ROUND	4	7

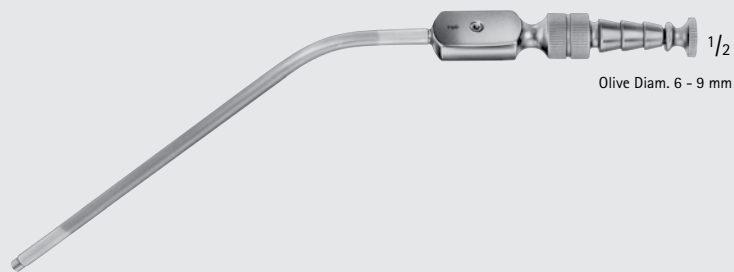

GF933R

Olive Diam. 6 - 9 mm

General Surgery

Suction Tubes

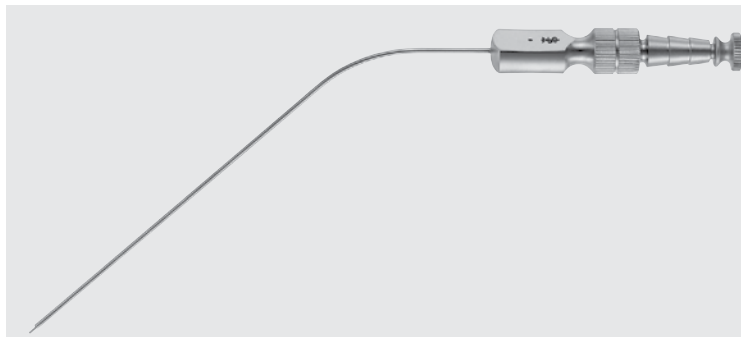

GF350R-GF385R

FERGUSSON Suction Tube, Luer Hub

Catalog Number	Diameter (mm)	Working Length (in.)	Length (in.)
GF350R	1.5	4 1/4	7 3/4
GF351R	2.0	4 1/4	7 3/4
GF352R	2.5	4 1/4	7 3/4
GF353R	3.0	4 1/4	7 3/4
GF354R	4.0	4 1/4	7 3/4
GF355R	5.0	4 1/4	7 3/4
GF360R	1.5	5 1/8	8 1/2
GF361R	2.0	5 1/8	8 1/2
GF362R	2.5	5 1/8	8 1/2
GF363R	3.0	5 1/8	8 1/2
GF364R	4.0	5 1/8	8 1/2
GF365R	5.0	5 1/8	8 1/2
GF370R	1.5	6 1/4	9 5/8
GF371R	2.0	6 1/4	9 5/8
GF372R	2.5	6 1/4	9 5/8
GF373R	3.0	6 1/4	9 5/8
GF374R	4.0	6 1/4	9 5/8
GF375R	5.0	6 1/4	9 5/8
GF380R	1.5	7 7/8	11
GF381R	2.0	7 7/8	11
GF382R	2.5	7 7/8	11
GF383R	3.0	7 7/8	11
GF384R	4.0	7 7/8	11
GF385R	5.0	7 7/8	11

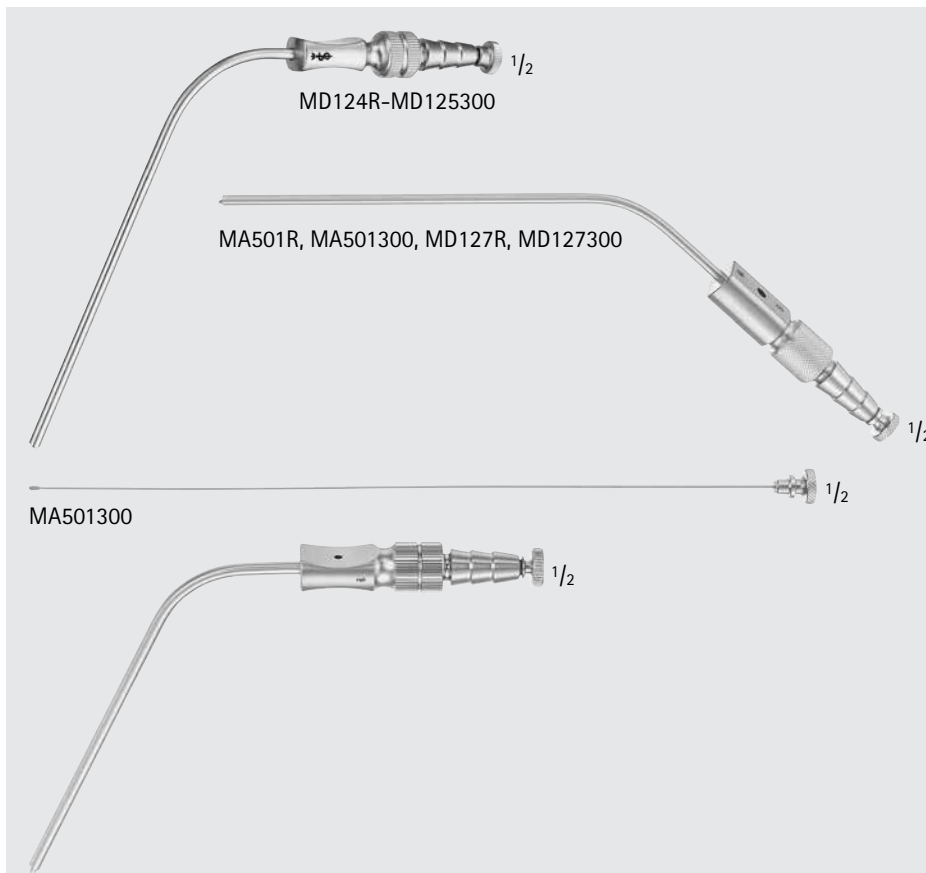

FRAZIER Suction Tube

Catalog Number	Tip Size (FR)	Description	Working Length (in.)
MD124R	7		4 1/4
MD124300	7	SUCTION STYLET W/ OLIVE TIP FOR MD124R	
MD125R	7		4 1/4
MD125300	8	SUCTION STYLET W/ OLIVE TIP FOR MD125R	
MA501R	9		4 1/4
MA501300		SUCTION STYLET W/ OLIVE TIP FOR MA501R	
MD127R	10		4 1/4
MD127300	10	SUCTION STYLET W/ OLIVE TIP FOR MD127R	
MA499R	11		4 1/4
MA499300	11	SUCTION STYLET W/ OLIVE TIP FOR MA499R	
MD129R	12		4 1/4
MD129300	12	SUCTION STYLET W/ OLIVE TIP FOR MD129R	



MF479R-MF489R, MF499R-MF508R

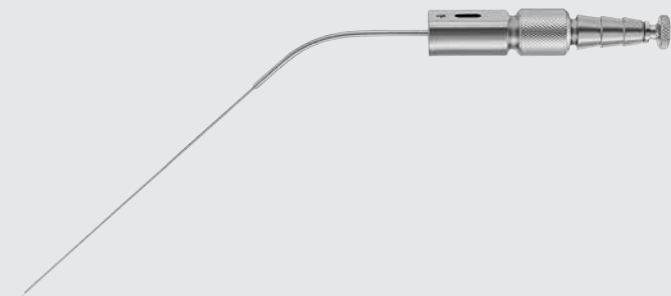

MF489R-MF498R, MF509R-MF518R

FRAZIER Slotted Suction Tube

Catalog Number	Tip Size (FR)	Shaft	Length (in.)
MF479R	3	STR	5 1/2
MF480R	4	STR	5 1/2
MF481R	5	STR	5 1/2
MF482R	6	STR	5 1/2
MF483R	7	STR	5 1/2
MF484R	8	STR	5 1/2
MF485R	9	STR	5 1/2
MF486R	10	STR	5 1/2
MF487R	11	STR	5 1/2
MF488R	12	STR	5 1/2
MF499R	3	STR	7
MF500R	4	STR	7
MF501R	5	STR	7
MF502R	6	STR	7
MF503R	7	STR	7
MF504R	8	STR	7
MF505R	9	STR	7
MF506R	10	STR	7
MF507R	11	STR	7
MF508R	12	STR	7
MF489R	3	ANG	5 1/2
MF490R	4	ANG	5 1/2
MF491R	5	ANG	5 1/2
MF492R	6	ANG	5 1/2
MF493R	7	ANG	5 1/2
MF494R	8	ANG	5 1/2
MF495R	9	ANG	5 1/2
MF496R	10	ANG	5 1/2
MF497R	11	ANG	5 1/2
MF498R	12	ANG	5 1/2
MF509R	3	ANG	7
MF510R	4	ANG	7
MF511R	5	ANG	7
MF512R	6	ANG	7
MF513R	7	ANG	7
MF514R	8	ANG	7
MF515R	9	ANG	7
MF516R	10	ANG	7
MF517R	11	ANG	7
MF518R	12	ANG	7



INCHES

General Surgery

Suction Tubes

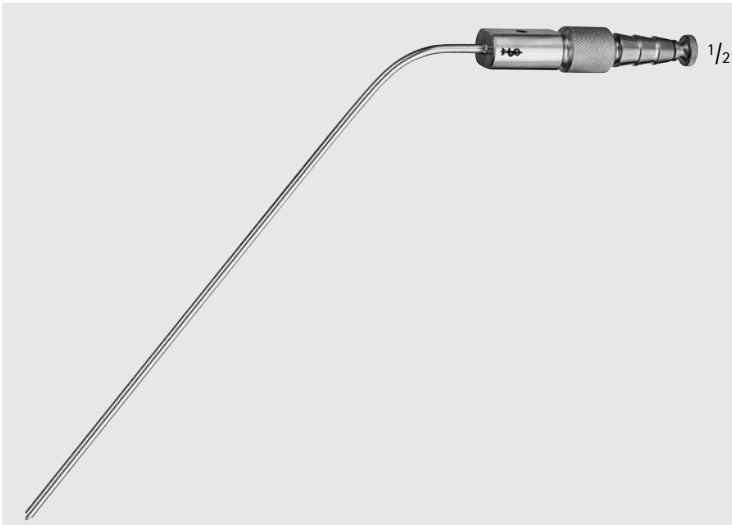

MD091-MD099

FRAZIER Long-Suction Tube

Catalog Number	Tip Size (FR)	Length (in.)
MD091	3	6 1/2
MD092	5	6 1/2
MD093	6	6 1/2
MD094	7	6 1/2
MD095	8	6 1/2
MD096	9	6 1/2
MD097	10	6 1/2
MD098	11	6 1/2
MD099	12	6 1/2



GF923R-GF925R

FRAZIER Suction Tube W/ Luer Hub

Catalog Number	Tip Size (FR)	Length (in.)
GF923R	9	7
GF925R	15	7

- Teardrop shaped thumb control for a very precise suction regulation
- Malleable material for individual forming of the suction hose
- Conical design of the tube prevents plugging
- Delivered with stylet

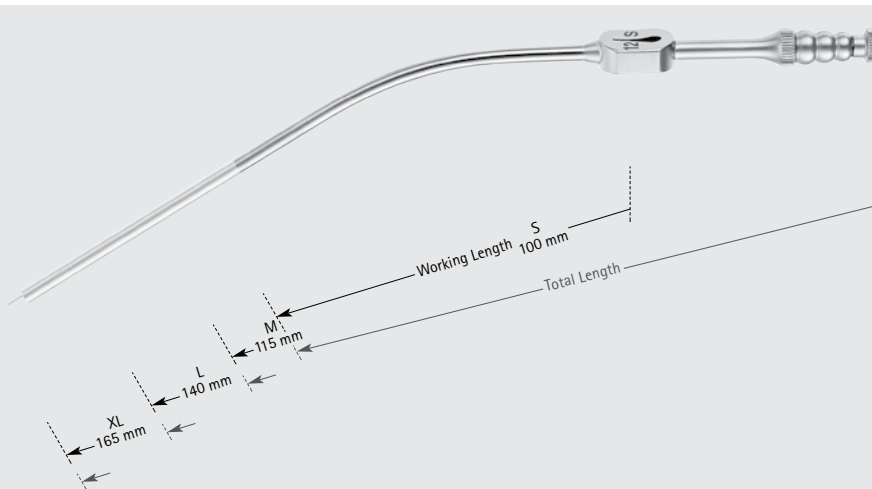

GF391R-GF429R

Suction Tube, Fukushima Style, W/ Tapered Teardrop Control

Catalog Number	Size	Tip Size (mm)	Tip Size (FR)	Working Length (in.)	Length (in.)
GF401R	S	1.0	3	4	6 1/2
GF402R	S	1.4	4	4	6 1/2
GF403R	S	1.7	5	4	6 1/2
GF404R	S	2.0	6	4	6 1/2
GF405R	S	2.3	7	4	6 1/2
GF406R	S	2.7	8	4	6 1/2
GF407R	S	3.0	9	4	6 1/2
GF408R	S	3.3	10	4	6 1/2
GF409R	S	4.0	12	4	6 1/2
GF391R	M	1.0	3	4 1/2	7
GF392R	M	1.4	4	4 1/2	7
GF393R	M	1.7	5	4 1/2	7
GF394R	M	2.0	6	4 1/2	7
GF395R	M	2.3	7	4 1/2	7
GF396R	M	2.7	8	4 1/2	7
GF397R	M	3.0	9	4 1/2	7
GF398R	M	3.3	10	4 1/2	7
GF399R	M	4.0	12	4 1/2	7
GF411R	L	1.0	3	5 1/2	8
GF412R	L	1.4	4	5 1/2	8
GF413R	L	1.7	5	5 1/2	8
GF414R	L	2.0	6	5 1/2	8
GF415R	L	2.3	7	5 1/2	8
GF416R	L	2.7	8	5 1/2	8
GF417R	L	3.0	9	5 1/2	8
GF418R	L	3.3	10	5 1/2	8
GF419R	L	4.0	12	5 1/2	8
GF421R	XL	1.0	3	6 1/2	9
GF422R	XL	1.4	4	6 1/2	9
GF423R	XL	1.7	5	6 1/2	9
GF424R	XL	2.0	6	6 1/2	9
GF425R	XL	2.3	7	6 1/2	9
GF426R	XL	2.7	8	6 1/2	9
GF427R	XL	3.0	9	6 1/2	9
GF428R	XL	3.3	12	6 1/2	9
GF429R	XL	4.0	12	6 1/2	9



INCHES

General Surgery

Suction Tubes



LANDOLT Dissecting Suction Tube

Catalog Number	Tip	Tip Size (mm)	Length (in.)
GF980R	ANG, SHARP	3.2	7 7/8

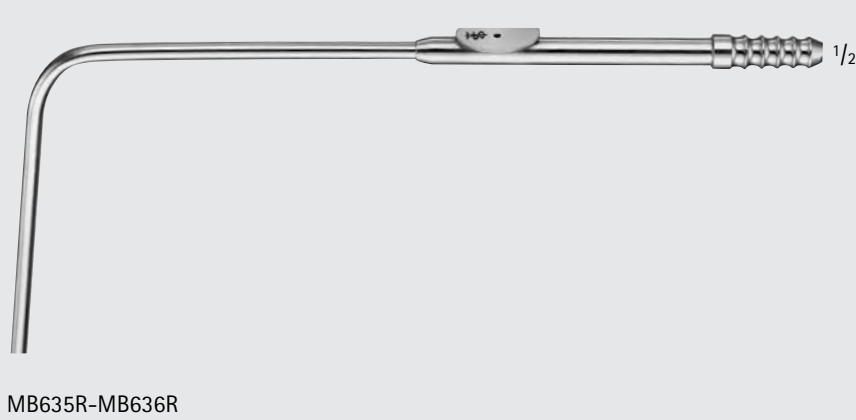

SACHS Suction Tube

Catalog Number	Tip Size	Length (in.)
MB635R	SMALL	8 1/2
MB636R	LARGE	8 1/2



PRIBRAM Suction Tube with Thumb Control

Catalog Number	Tip	Length (in.)
US106	16	5 1/2
US107	18	5 1/2



OCHSNER Trocar

Catalog Number	Tip Size (FR)	Length (in.)
MG100R	10	6
MG101R	12	6
MG102R	14	6
MG103R	16	6
MG104R	18	6
MG105R	20	6
MG106R	22	6
MG107R	24	6
MG108R	26	6
MG109R	27	6
MG110R	28	6

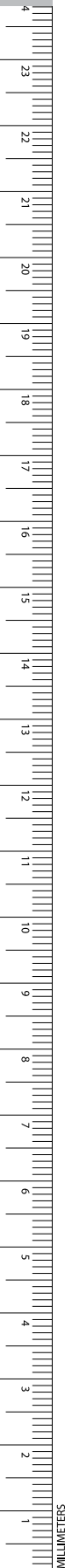



AA804R-AA806R

Steel Ruler, Graduated In Millimeters and Inches

Catalog Number	Length (in.)
AA804R	6
AA805R	11 3/4
AA806R	19 3/4

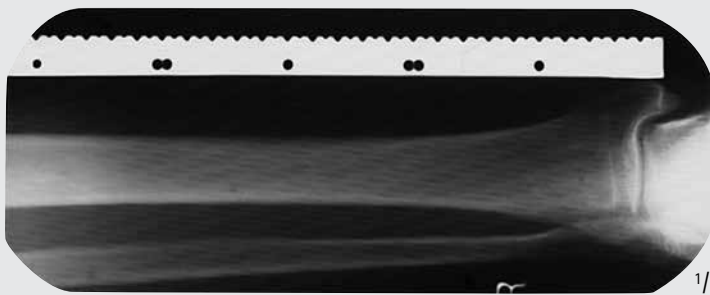

AA808R

Ruler, F/ X-Ray Work

Catalog Number	Length (in.)
AA808R	19 3/4



AD110R

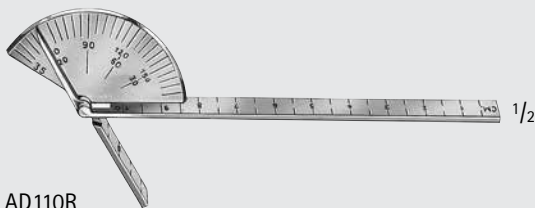

Finger-Goniometer

Catalog Number	AD110R
----------------	--------



INCHES

General Surgery

Accessories



MG001R-MG004R

Surgical Spoon

Catalog Number	Size	Blade Size (mm)	Length (in.)
MG003R	SMALL	25	4 1/4
MG002R	MEDIUM	30	5 1/4
MG004R	MEDIUM-LARGE	35	6 1/4
MG001R	LARGE	40	7 1/2



783101-783102

1/2

Staple Remover

Catalog Number	Description
783102	REUSABLE
783101	SINGLE USE (BOX OF 6)



MG377R-MG378R

TAYLOR Percussion Hammer

Catalog Number	Size	Length (in.)
MG377R	SMALL	7
MG378R	LARGE	7 3/4

General Surgery

Metal Bowls and Cups

GENERAL SURGERY

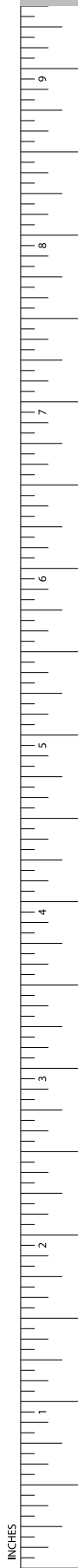

Metal Sponge Bowl

Catalog Number	Capacity (qts.)
US061	1
US060	1 1/2
US062	1 7/8



US060-US062

1/2

Metal Cup

Catalog Number	Item	Capacity (oz.)
US066	MEDICINE CUP	2
US063	IODINE CUP	6
US067	SOLUTION BASIN	12
US065	IODINE CUP	14
US064	GRADUATED MEASURE	32



US063-US067

1/2

Kidney Tray

Catalog Number	Length (in.)
JG504R	6 3/4
JG506R	9 3/4



JG504R-JG506R

INCHES

General Surgery

GENERAL SURGERY

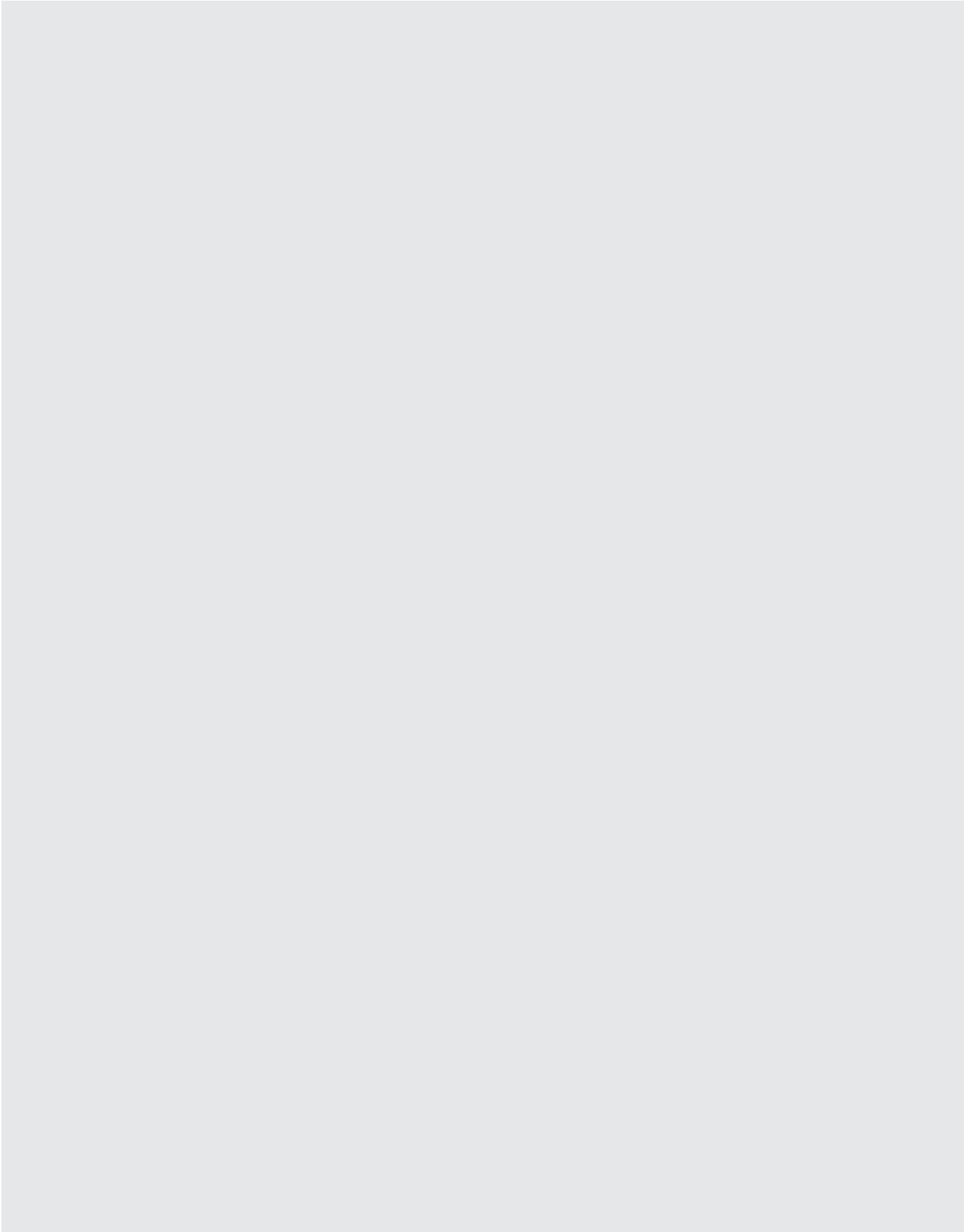
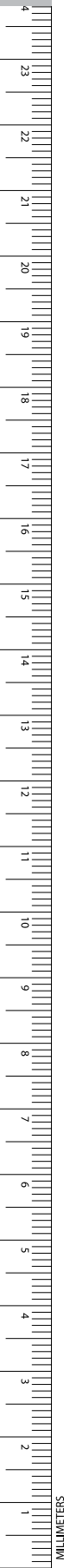



Cardiovascular

Scissors	328 - 356
Needle Holders	357 - 370
Forceps	371 - 377
Titanium Forceps and Clamps	378 - 389
Forceps and Clamps	390 - 399
Vascular Clamps	400 - 481
Bulldog and Micro Vessel Clamps	482 - 490
Vessel Instruments	491 - 493
Specialty CV/Thoracic Instruments and Retractors ..	494 - 507
Retractors	508 - 517
Rib Spreaders	518 - 533

Cardiovascular

Scissors

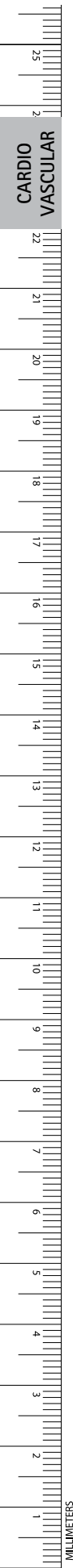

CARDIO
VASCULAR



BC034R 1/2

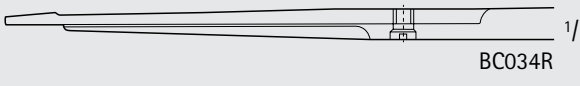

BC034R 1/1

Vessel Scissors

Catalog Number	Tip	Blade	Length (in.)
BC034R	B/B	1-PROBE-PT	5 3/4

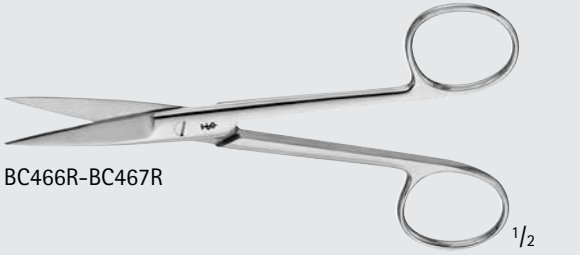

BC466R-BC467R 1/2



BC466R 1/1

MAYO Operating Scissors

Catalog Number	Tip	Blade	Length (in.)
BC466R	S/S	STR	5 1/2
BC467R	S/S	CVD	5 1/2

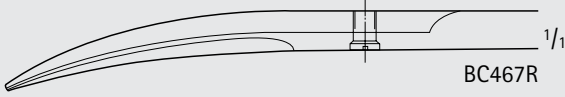

BC467R 1/1

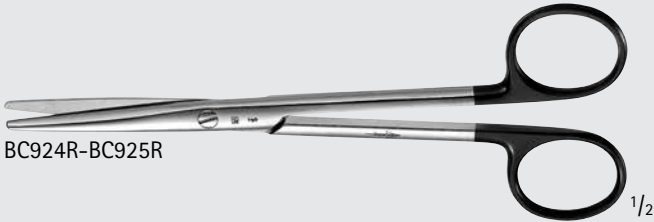

BC924R-BC925R 1/2

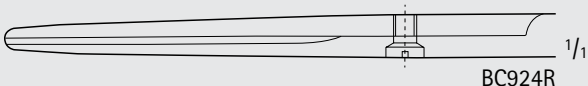

BC924R 1/1

MAYO SuperCut Scissors, Delicate

Catalog Number	Tip	Blade	Length (in.)
BC924R	B/B	STR	6 1/2
BC925R	B/B	CVD	6 1/2

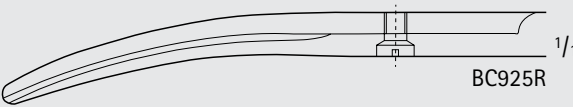

BC925R 1/1



CHURCH Scissors, Beveled

Catalog Number	Tip	Blade	Length (in.)
MB618R	B/B	STR	7
MB619R	B/B	CVD	7

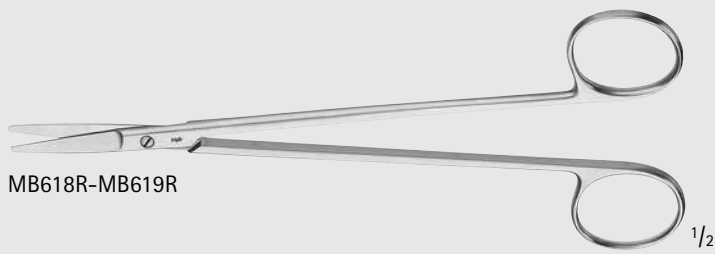

MB618R-MB619R

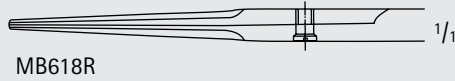

MB618R

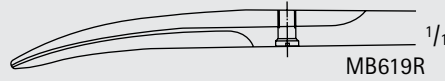

MB619R

DEBAKEY Arteriotomy Scissors

Catalog Number	Tip	Blade	Length (in.)
BC629R	B/B	CVD	6 7/8

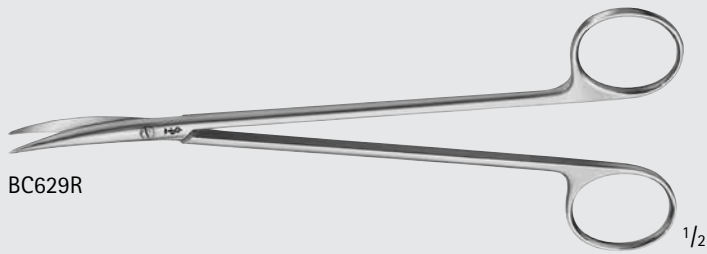

BC629R

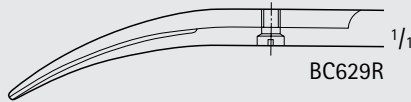

BC629R

THOREK Scissors

Catalog Number	Tip	Blade	Length (in.)
BC636R	B/B	HEAVY-CVD	7

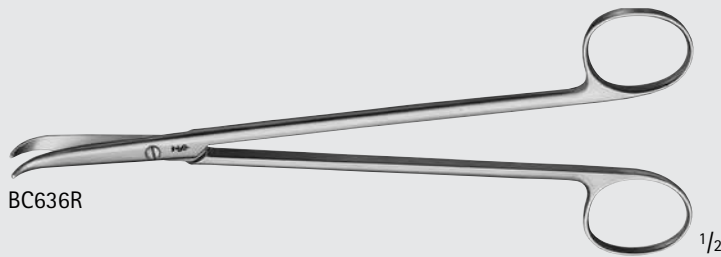

BC636R

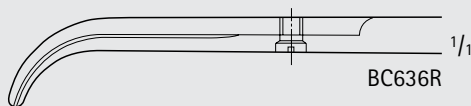

BC636R

SCHMIEDEN-TAYLOR Dura Scissors

Catalog Number	Tip	Blade	Length (in.)
BC660R	1 BALL-PT	ANG	6 1/8

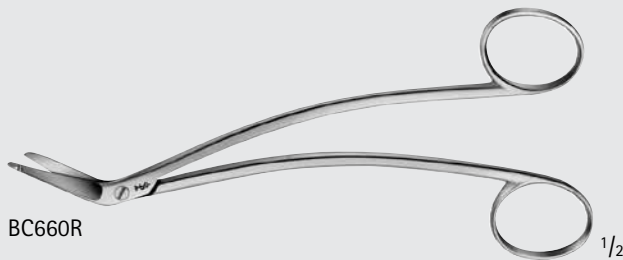

BC660R

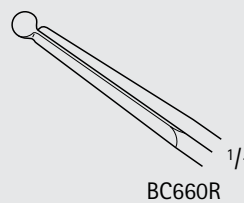

BC660R

Cardiovascular

Scissors



CARDIO
VASCULAR

SATINSKY Vena Cava Scissors

Catalog Number	Blade	Length (in.)
BC641R	CVD	9 5/8

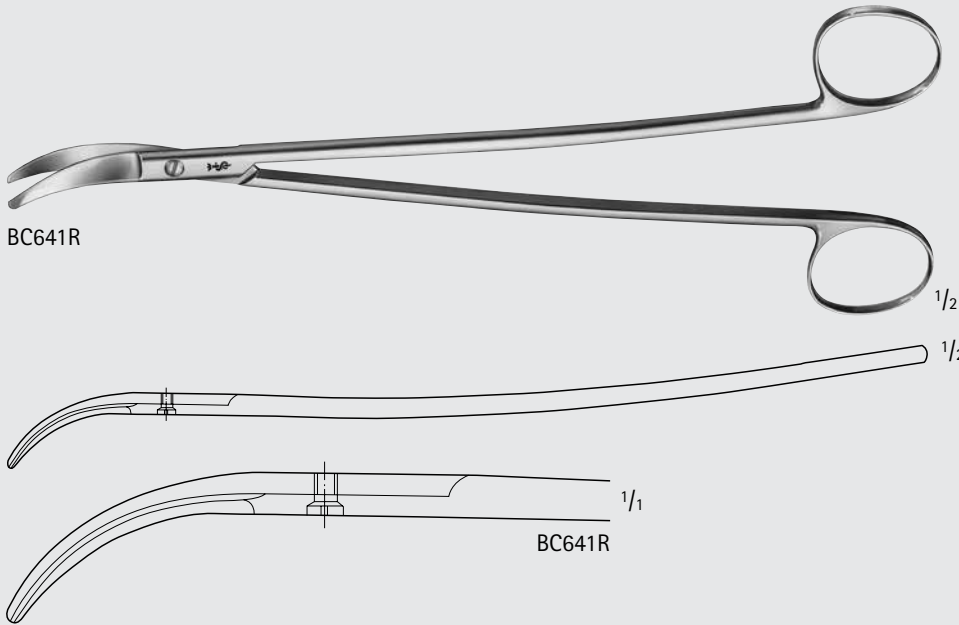

STRULLY Scissors

Catalog Number	Tip	Blade	Length (in.)
BC644R	S/S	CVD	8 3/4

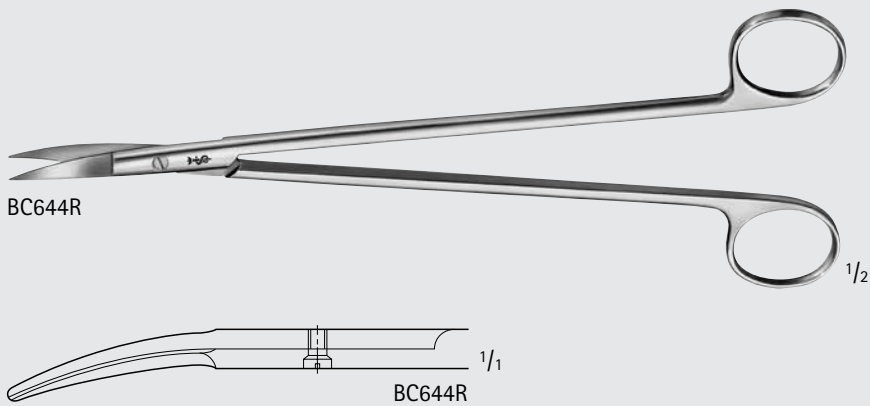

STRULLY Scissors

Catalog Number	Tip	Blade	Length (in.)
BC645R	PROBE	CVD	8 3/4

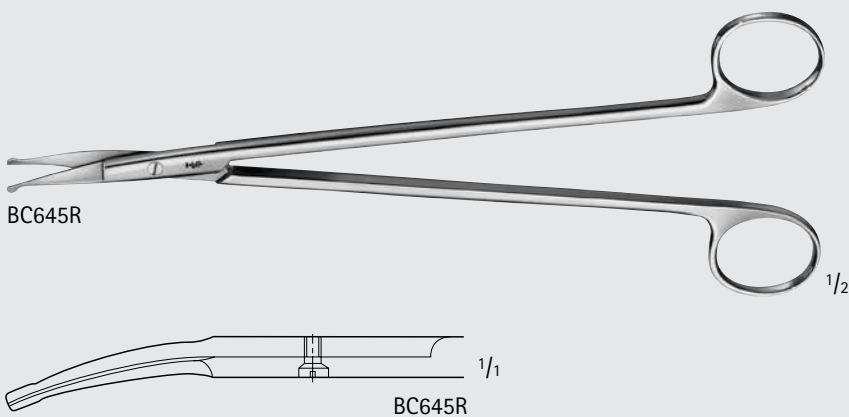



POTTS-SMITH Dissecting Scissors

Catalog Number	Tip	Blade	Length (in.)
MG381R	B/B	CVD	5 1/2
BC643R	B/B	CVD	7 1/2
BC191R	B/B	CVD	9
US145	B/B	CVD	11 1/4

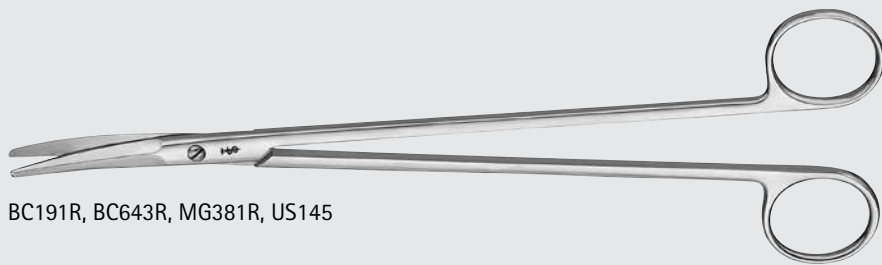

BC191R, BC643R, MG381R, US145

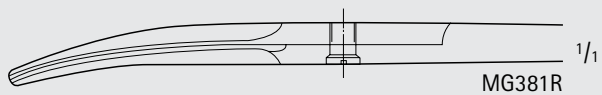

MG381R

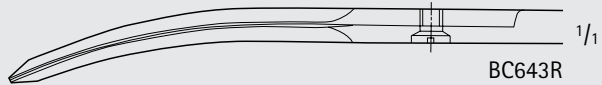

BC643R



BC191R



US145

MORSE Scissors

Catalog Number	Tip	Blade	Length (in.)
BC196R	S/S	CVD	6 7/8

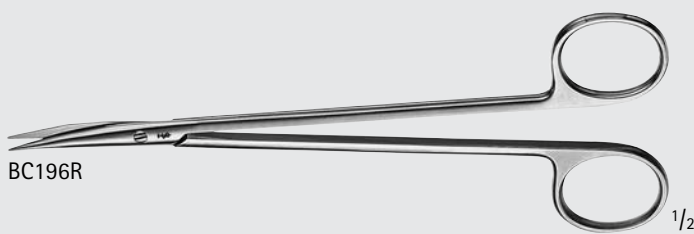

BC196R



BC196R

HOHENFELLNER Scissors

Catalog Number	Tip	Blade	Length (in.)
BC638R	B/B	CVD	8 7/8
BC639R	B/B	CVD	10

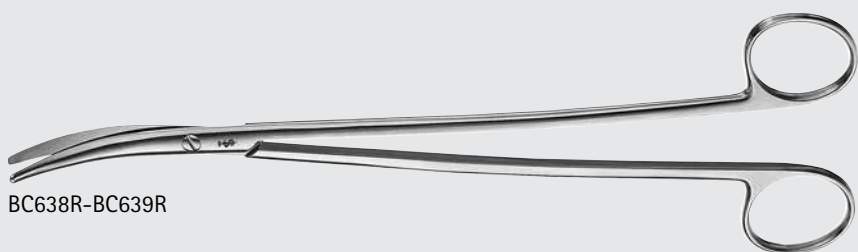

BC638R-BC639R

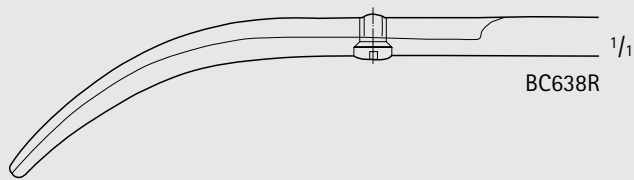

BC638R

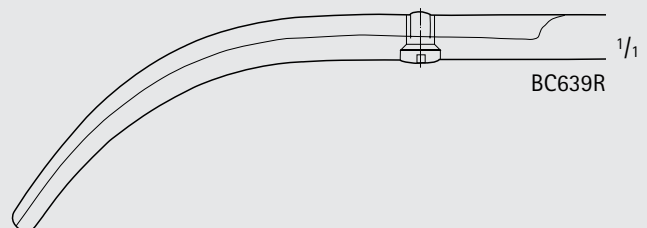

BC639R

Cardiovascular

Scissors

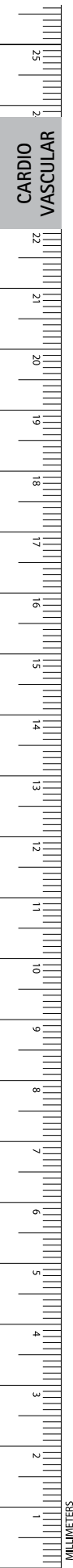

CARDIO
VASCULAR

JAMESON-METZENBAUM Scissors

Catalog Number	Tip	Blade	Length (in.)
MG383R	S/S	CVD	9

MG383R $\frac{1}{2}$

MG383R $\frac{1}{1}$

LILLEHEI-POTTS Tenotomy Scissors

Catalog Number	Tip	Blade	Length (in.)
MG382R	S/S	CVD	7

MG382R $\frac{1}{2}$

MG382R $\frac{1}{1}$

JAMESON Tenotomy Scissors, Delicate

Catalog Number	Tip	Blade	Length (in.)
BC177R	B/B	CVD	6

BC177R $\frac{1}{2}$

BC177R $\frac{1}{1}$



POTTS Tenotomy Scissors

Catalog Number	Tip	Blade	Length (in.)
BC178R	B/B	CVD	6 7/8
BC179R	B/B	CVD	8

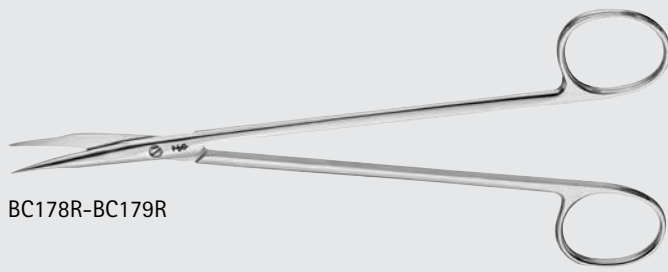

BC178R-BC179R



BC178R



BC179R

JAMESON SuperCut Scissors, Delicate

Catalog Number	Tip	Blade	Length (in.)
BC911R	B/B	CVD	5 1/8
BC915R	B/B	CVD	6
BC919R	B/B	CVD	7



BC911R, BC915R, BC919R



BC911R



BC915R



BC919R

Cardiovascular

Delicate Scissors

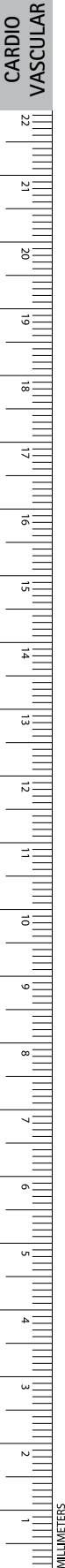

CARDIO
VASCULAR

BC936R-BC937R

1/2

1/1 BC936R

1/1 BC937R

METZENBAUM SuperCut Scissors

Catalog Number	Tip	Blade	Length (in.)
BC936R	B/B	STR	7
BC937R	B/B	CVD	7

BC945R-BC953R

1/1

1/1 BC945R

1/1 BC947R

1/1 BC949R

1/1 BC951R

1/1 BC953R

METZENBAUM SuperCut Scissors

Catalog Number	Tip	Blade	Length (in.)
BC945R	B/B	CVD	9
BC947R	B/B	CVD	10 1/4
BC949R	B/B	CVD	11 1/4
BC951R	B/B	CVD	11 3/4
BC953R	B/B	CVD	14



GORNEY Scissors

Catalog Number	Tip	Blade	Length (in.)
BC188R	B/B	STR	7 3/4
BC189R	B/B	SLIGHT-CVD	7 3/4



BC188R-BC189R

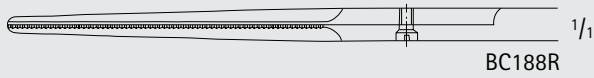

BC188R

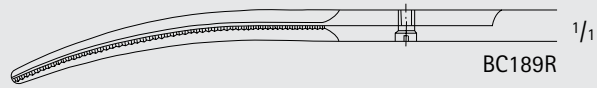

BC189R

COOLEY Cardiovascular Scissors

Catalog Number	Tip	Blade	Length (in.)
BC597R	B/B	CVD	7 1/2
BC599R	B/B	CVD	9

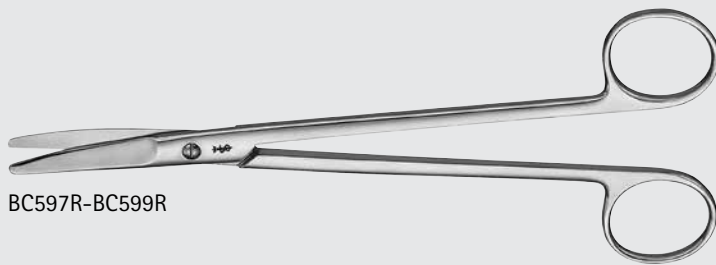

BC597R-BC599R

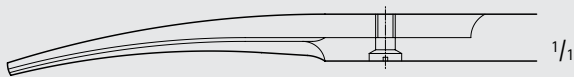

BC597R-BC599R

POTTS-SMITH Lateral Angle Scissors

Catalog Number	Tip	Blade Angle	Blade Length (mm)	Length (in.)
BC646R	S/S	55°	19	7

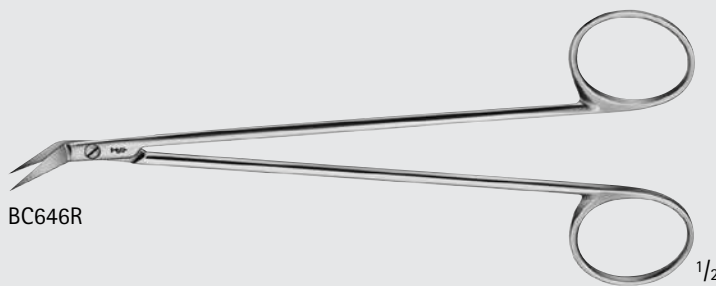

BC646R

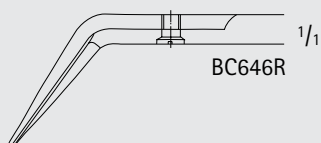

BC646R

Cardiovascular

Delicate Scissors

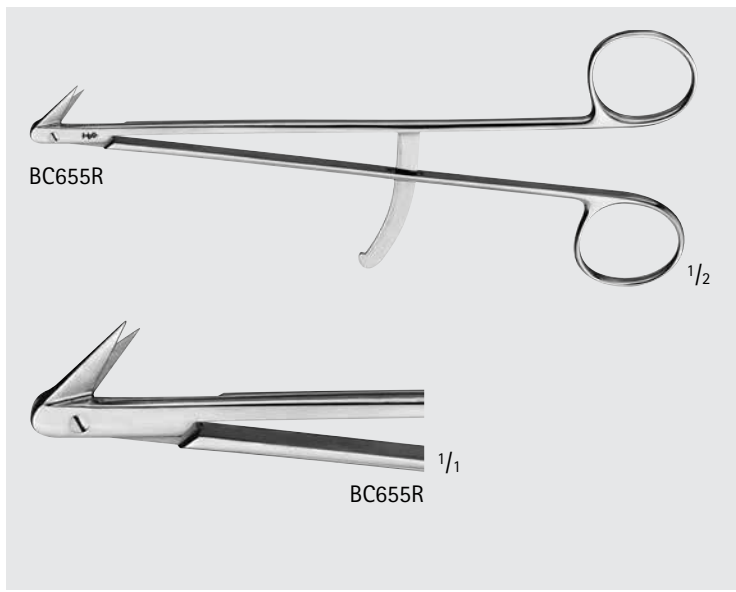
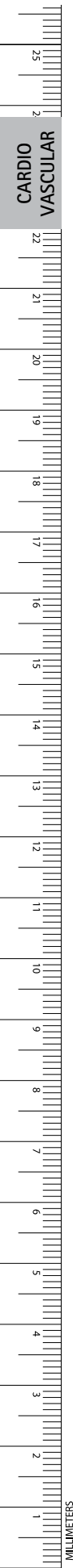

POTTS-SMITH Reverse Scissors

Catalog Number	Tip	Blade Angle	Handle	Length (in.)
BC655R	S/S	130°	W/ STABILIZING BAR	7

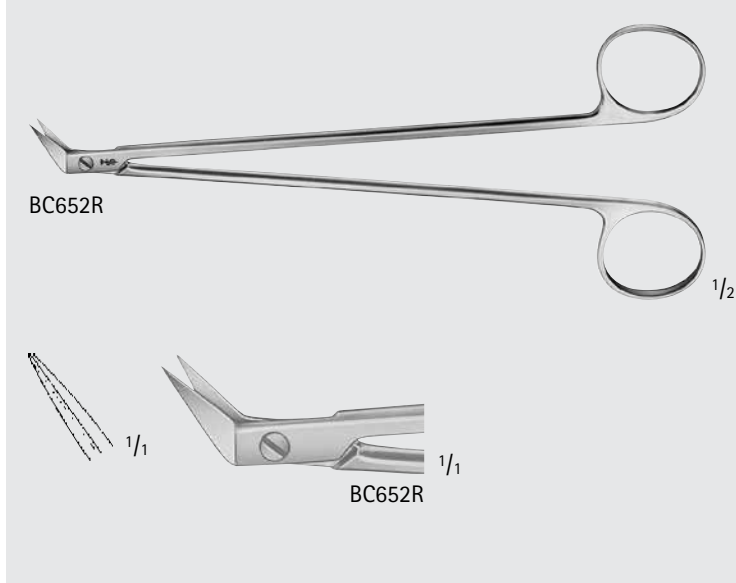

POTTS-SMITH Vessel Scissors

Catalog Number	Tip	Blade Angle	Blade Length (mm)	Length (in.)
BC652R	S/S	60°	10	6 7/8

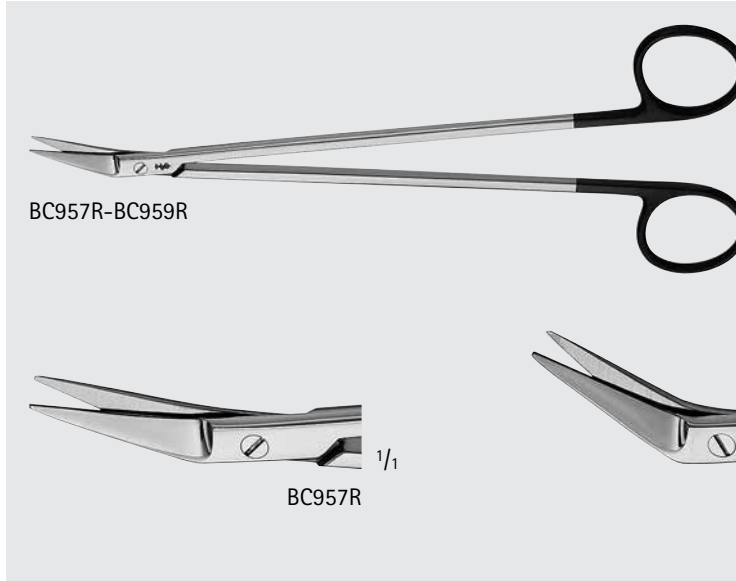

POTTS-SMITH SuperCut Scissors

Catalog Number	Tip	Blade Angle	Blade Length (mm)	Length (in.)
BC957R	B/B	25°	22	7 1/2
BC958R	B/B	45°	20	7 1/4
BC959R	B/B	60°	19	7



POTTS-DE MARTEL Scissors

Catalog Number	Tip	Blade Angle	Blade Length (mm)	Length (in.)
BC647R	S/S	30°	21	7 1/4
BC648R	S/S	45°	21	7 1/4
BC649R	S/S	60°	21	7 1/4
BC650R	S/S	60°	21	8 3/4

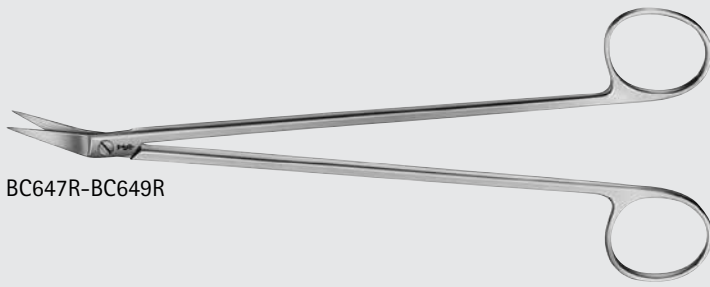

BC647R-BC649R

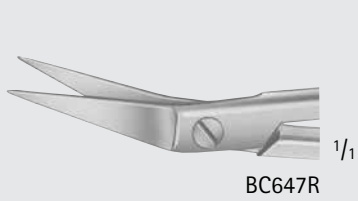

BC647R



BC648R

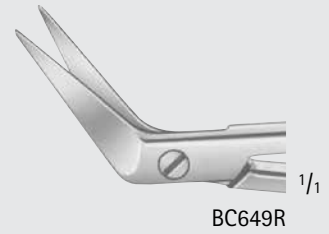

BC649R

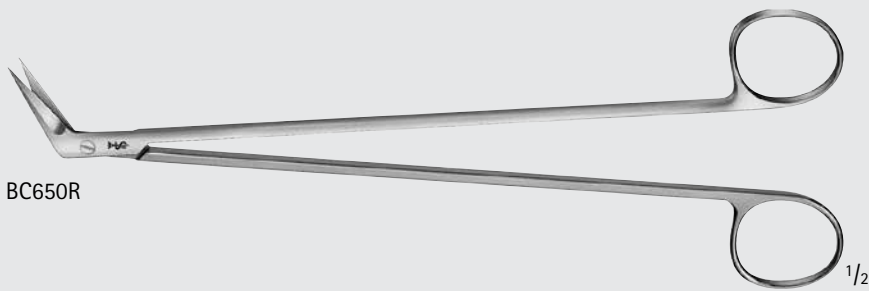

BC650R

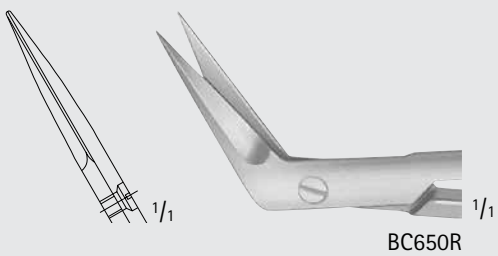

BC650R

MILLS Scissors

Catalog Number	Tip	Blade	Blade Length (mm)	Length (in.)
BC651R	1 BALL-POINT	60°	23	8 3/4

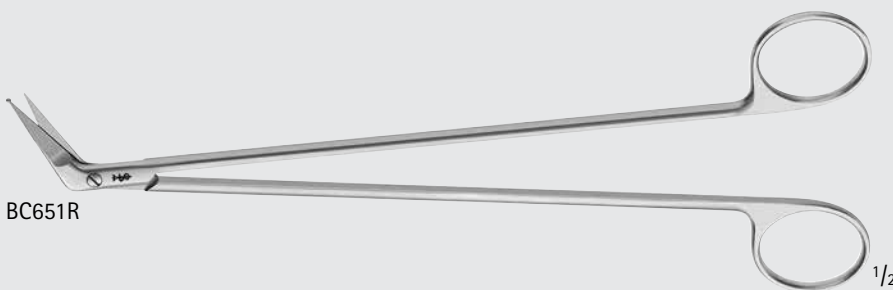

BC651R

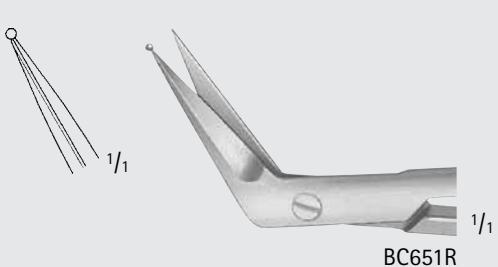

BC651R

Cardiovascular

Delicate Scissors

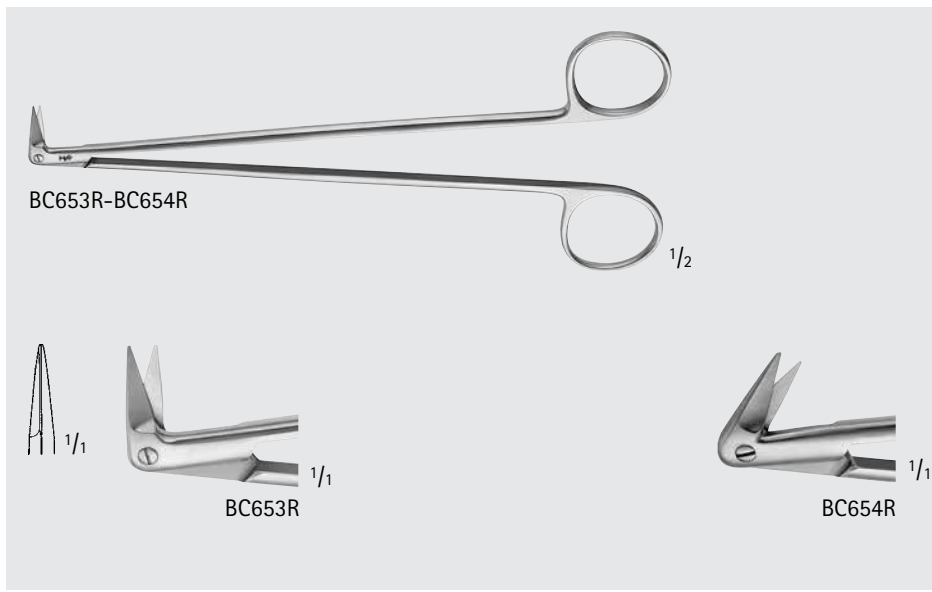
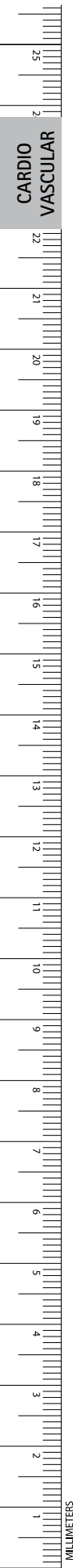

DIETHRICH Vessel Scissors

Catalog Number	Tip	Blade Angle	Blade Length (mm)	Length (in.)
BC653R	S/S	90°	12	6 3/4
BC654R	S/S	120°	10	6 3/4

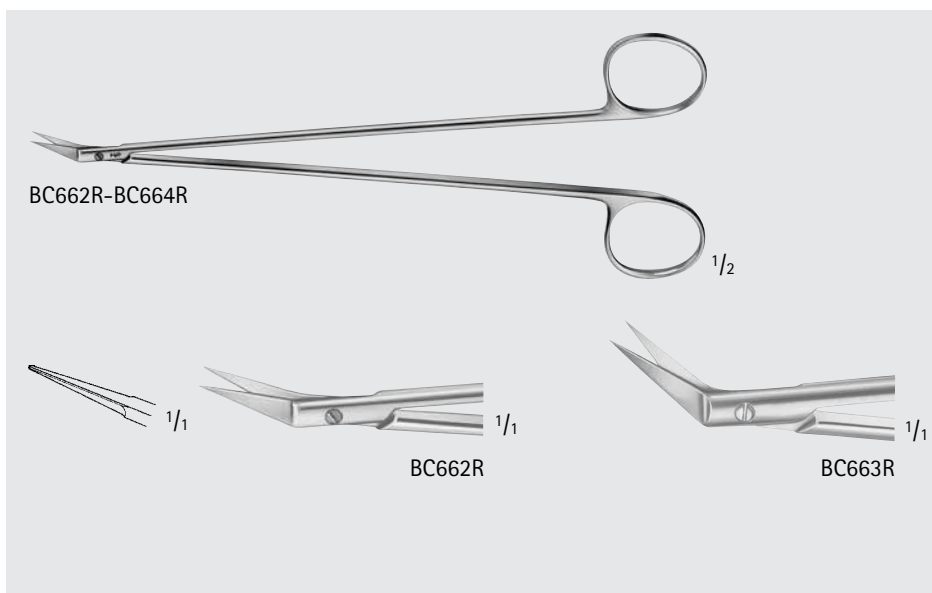

DIETHRICH-HEGEMANN Vessel Scissors

Catalog Number	Tip	Blade Angle	Blade Length (mm)	Length (in.)
BC662R	S/S	25°	15	7
BC663R	S/S	45°	15	7
BC664R	S/S	60°	15	7

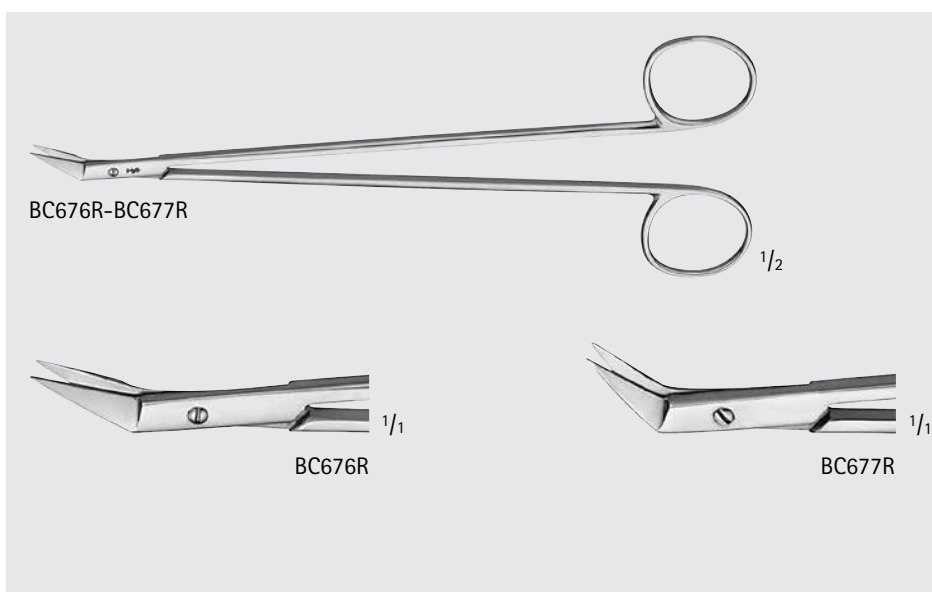

DIETHRICH Coronary Artery Scissors

Catalog Number	Tip	Blade Angle	Blade Length (mm)	Length (in.)
BC676R	S/S	25°	13	7 1/4
BC677R	S/S	45°	14	7 1/4

COOLEY Arteriotomy Scissors

Catalog Number	Tip	Blade Angle	Blade Length (mm)	Length (in.)
BC678R	B/B	30°	21.5	8 7/8
BC679R	B/B	30°	21.5	10 3/4

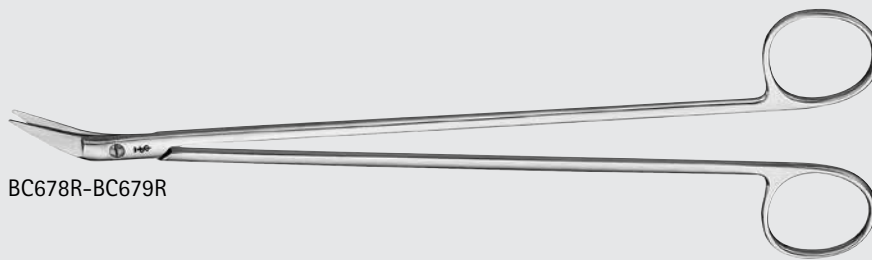

BC678R-BC679R



BC678R



BC679R

DEBAKEY Vessel Scissors

Catalog Number	Tip	Blade Angle	Blade Length (mm)	Length (in.)
BC656R	S/S	45°	18	6 1/8
BC657R	S/S	60°	18	6 1/8

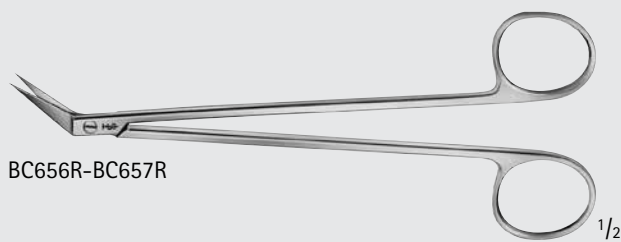

BC656R-BC657R

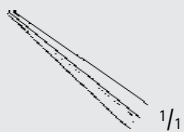

1/1

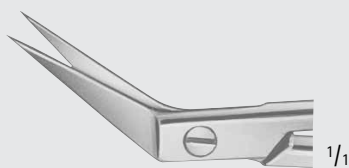

BC656R



BC657R

DEBAKEY Offset Scissors, S-Shaped

Catalog Number	Tip	Blade Angle	Blade Length (mm)	Length (in.)
BC669R	S/S	45°	24	6 1/8

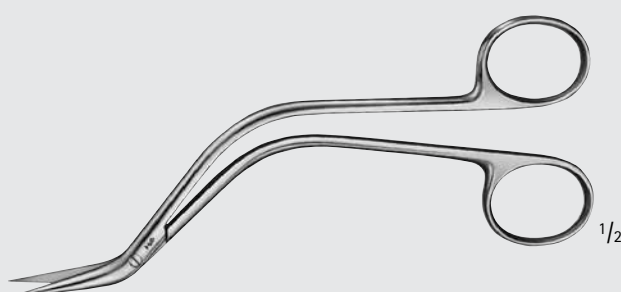

BC669R

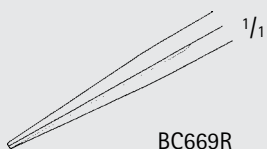

BC669R

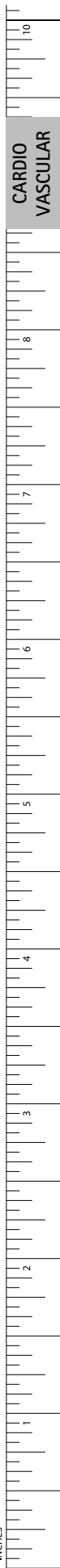

INCHES

Cardiovascular

Delicate Scissors

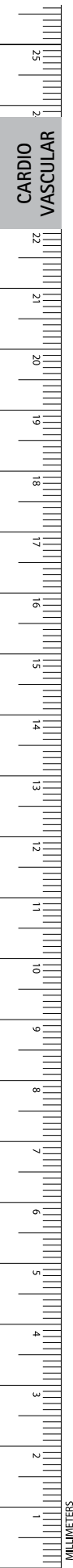

CARDIO
VASCULAR

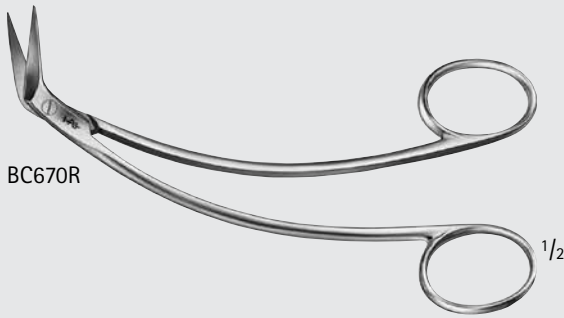

BC670R

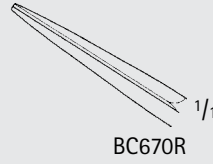

BC670R

FAVOLORO Artery Scissors

Catalog Number	Tip	Blade Angle	Blade Length (mm)	Length (in.)
BC670R	S/S	45°	20	5 1/2

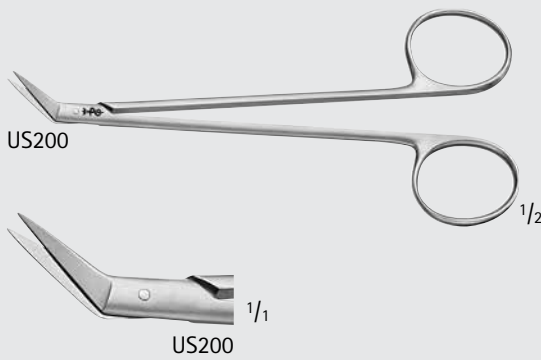

US200

US200

POTTS Vascular Scissors

Catalog Number	Tip	Blade Angle	Blade Length (mm)	Length (in.)
US200	S/S	45°	13	5 1/4

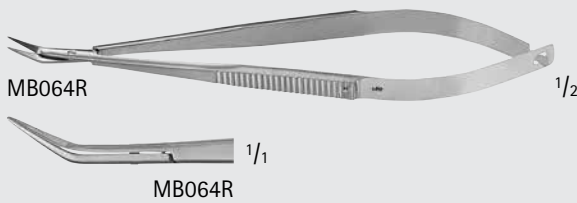

MB064R

MB064R

Valve Leaflet Excision Scissors

Catalog Number	Tip	Blade Angle	Length (in.)
MB064R	B/B	45°	5 3/4

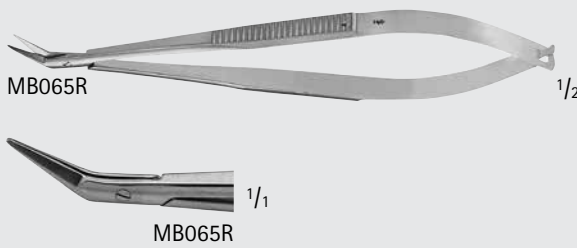

MB065R

MB065R

POTTS Arteriotomy Scissors

Catalog Number	Tip	Blade Angle	Length (in.)
MB065R	B/B	60°	5 3/8

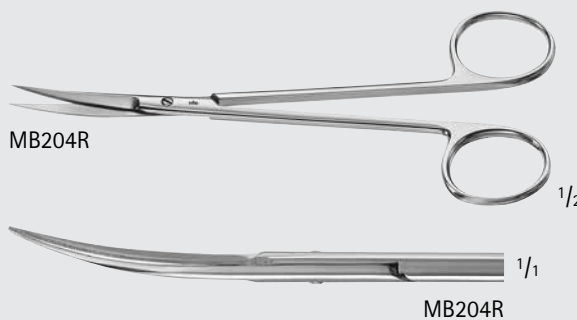

MB204R

MB204R

COOLEY Neonatal Scissors

Catalog Number	Tip	Blade	Length (in.)
MB204R	S/S	CVD	5 3/4

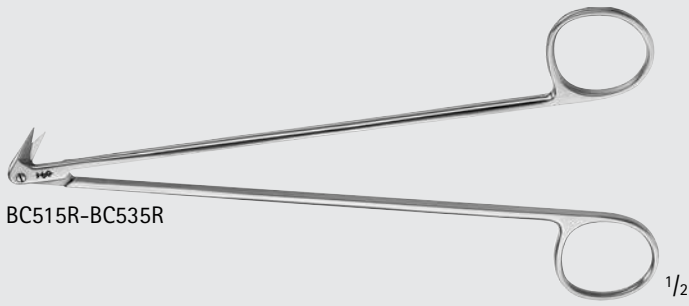

BC515R-BC535R

DIETHRICH-POTTS Micro Scissors

Catalog Number	Tip	Blade	Blade Angle	Blade Length (mm)	Length (in.)
BC515R	S/S	X-DEL	25°	8	7
BC516R	S/S	X-DEL	45°	8	7
BC517R	S/S	X-DEL	60°	8	7
BC518R	S/S	X-DEL	90°	8	7
BC519R	S/S	X-DEL	125°	8	7
BC531R	S/S	DEL	25°	10	7
BC532R	S/S	DEL	45°	10	7
BC533R	S/S	DEL	60°	10	7
BC534R	S/S	DEL	90°	10	7
BC535R	S/S	DEL	125°	10	7
BC522R	S/S	FINE	25°	12	7
BC523R	S/S	FINE	45°	12	7
BC524R	S/S	FINE	60°	12	7
BC525R	S/S	FINE	90°	12	7
BC526R	S/S	FINE	125°	12	7

Blade Length: 8 MM

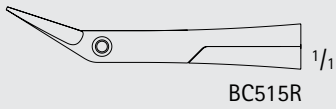

BC515R

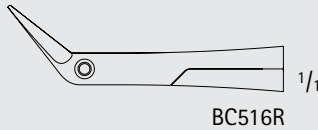

BC516R

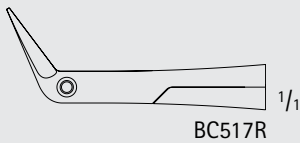

BC517R

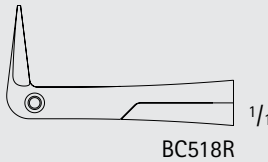

BC518R

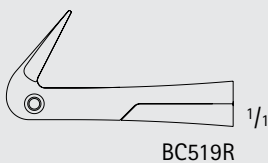

BC519R

Blade Length: 10 MM

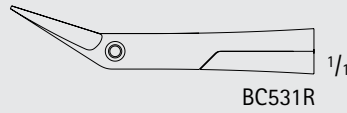

BC531R

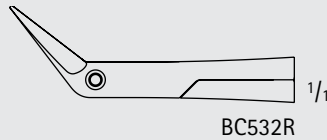

BC532R

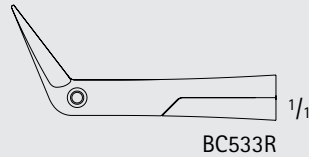

BC533R

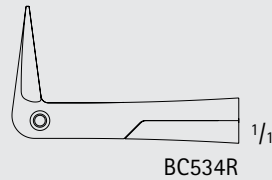

BC534R

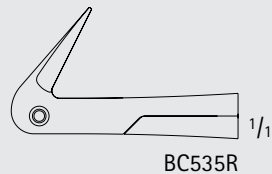

BC535R

Blade Length: 12 MM

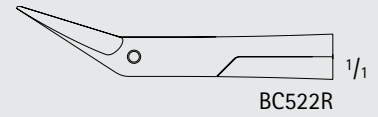

BC522R

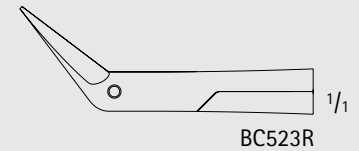

BC523R

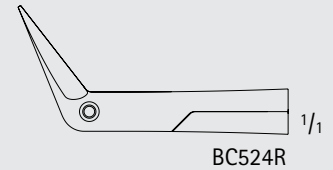

BC524R

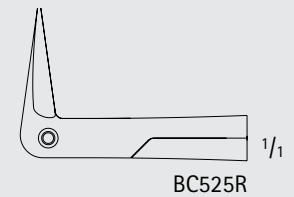

BC525R

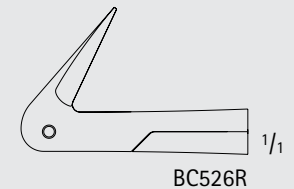

BC526R



CARDIO
VASCULAR

Cardiovascular

Scissors

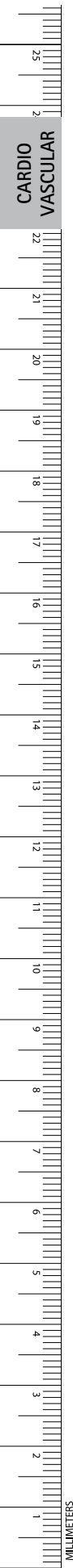

CARDIO
VASCULAR

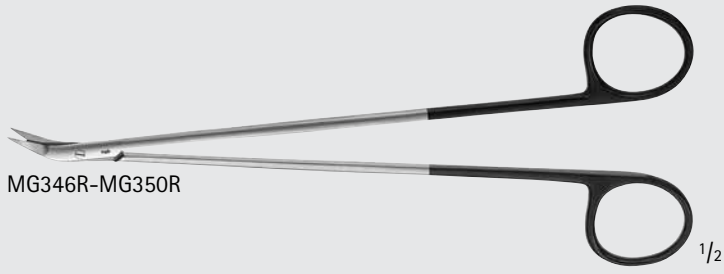

MG346R-MG350R

1/2



MG346R

1/1



MG347R

1/1



MG348R

1/1



MG349R

1/1



MG350R

1/1

DIETHRICH SuperCut Scissors

Catalog Number	Tip	Blade	Length (in.)
MG346R	S/S	25°	7
MG347R	S/S	45°	7
MG348R	S/S	60°	7
MG349R	S/S	90°	7
MG350R	S/S	125°	7



DUROTIP TC Tungsten Carbide Scissors

- Excellent cutting accuracy
- Long working life
- Gold-plated rings

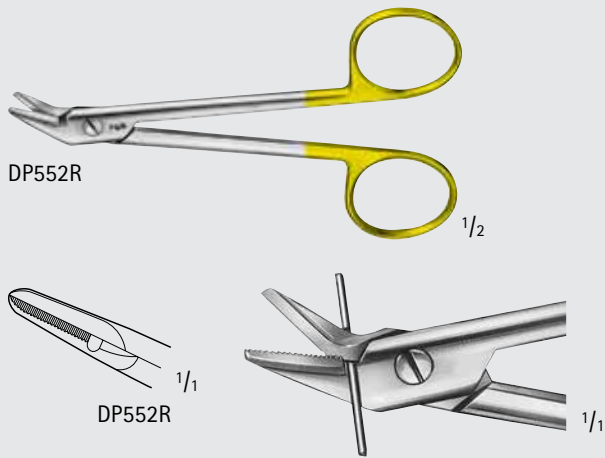

DUROTIP TC Wire Cutting Scissors

Catalog Number	Blade	For Wire Size	Length (in.)
DP552R	1-SERR	SOFT, UP TO 1.2 MM AND HARD, UP TO 0.8 MM	4 3/4

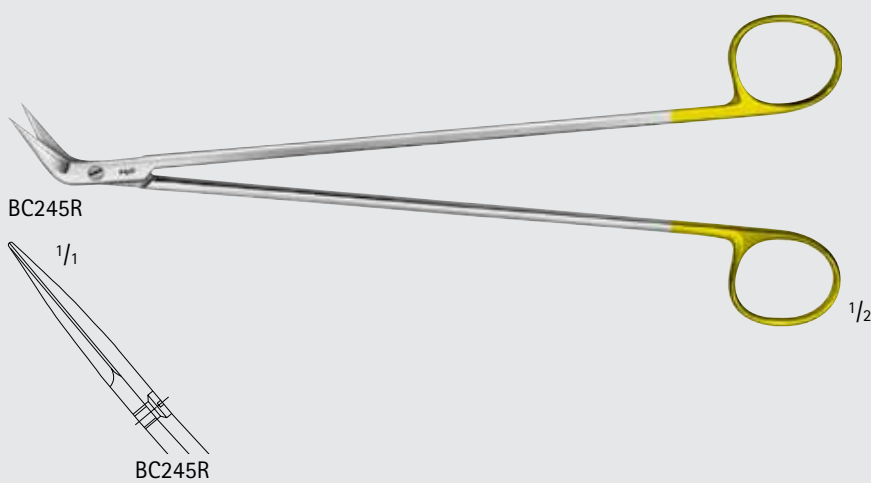

DUROTIP TC DEBAKEY Vascular Scissors

Catalog Number	Tip	Blade Angle	Blade Length (mm)	Length (in.)
BC245R	S/S	60°	21	8 3/4

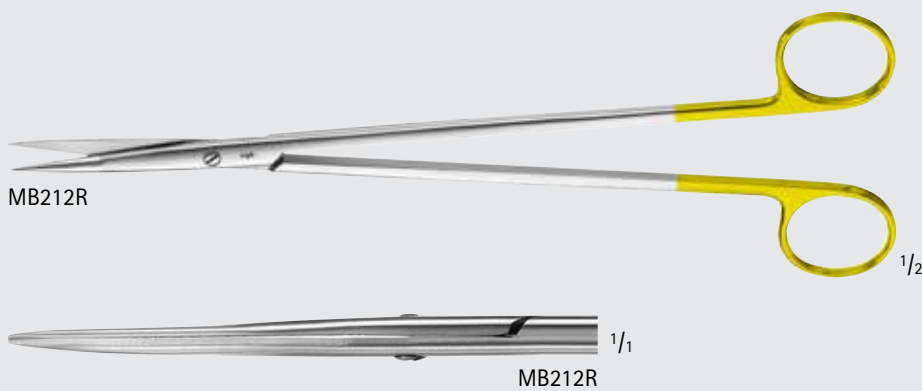

DUROTIP TC DEMARTEL Vascular Scissors

Catalog Number	Tip	Blade	Length (in.)
MB212R	S/S	CVD	6 3/4

Cardiovascular

DUROTIP™ TC Scissors

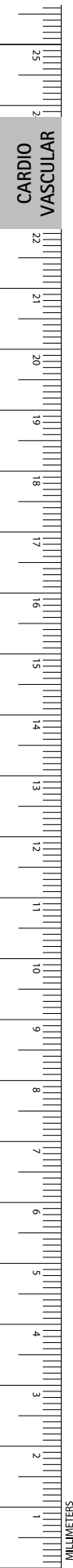

CARDIO
VASCULAR



BC258R-BC259R 1/2

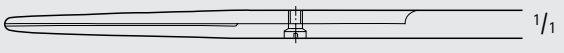

BC258R 1/1

**DUROTIP TC Baby METZENBAUM
Dissecting Scissors, Delicate**

Catalog Number	Tip	Blade	Length (in.)
BC258R	B/B	STR	5 3/4
BC259R	B/B	CVD	5 3/4

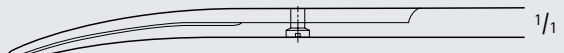

BC259R 1/1

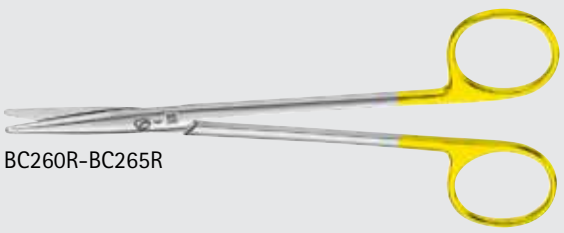

BC260R-BC265R 1/2

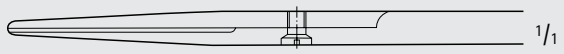

BC260R 1/1

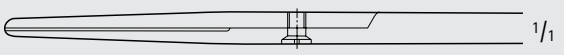

BC262R 1/1

**DUROTIP TC METZENBAUM Dissecting
Scissors**

Catalog Number	Tip	Blade	Length (in.)
BC260R	B/B	STR	5 3/4
BC262R	B/B	STR	7
BC261R	B/B	CVD	5 3/4
BC263R	B/B	CVD	7
BC265R	B/B	CVD	7 7/8
BC287R	B/B	CVD	9

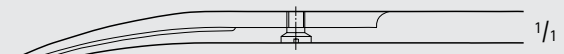

BC261R 1/1

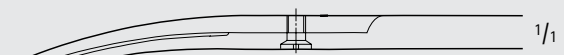

BC263R 1/1

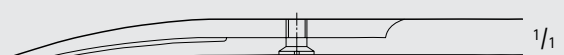

BC265R 1/1



BC287R 1/2

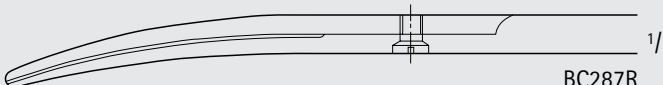

BC287R 1/1

DUROTIP TC METZENBAUM Dissecting Scissors, Delicate

Catalog Number	Tip	Blade	Length (in.)
MB205R	S/S	STR	9 1/4
MB207R	S/S	CVD	5 3/4
MD496	S/S	CVD	7
MB206R	S/S	CVD	9 1/4

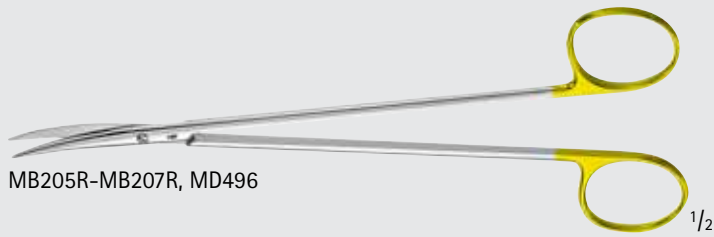

MB205R-MB207R, MD496

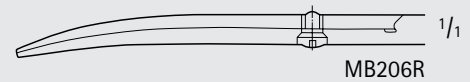
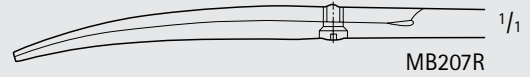

DUROTIP TC MAYO Dissecting Scissors

Catalog Number	Tip	Blade	Length (in.)
BC558R	B/B	STR	9
BC559R	B/B	CVD	9

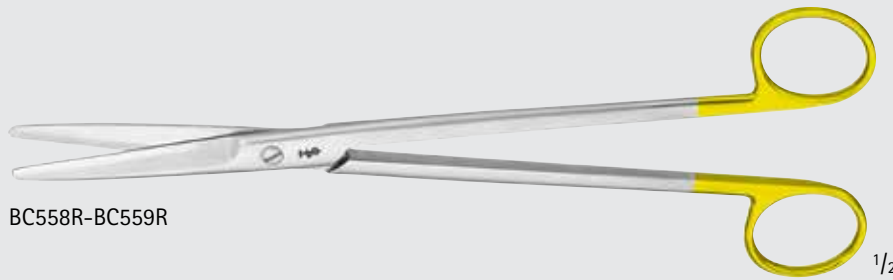

BC558R-BC559R

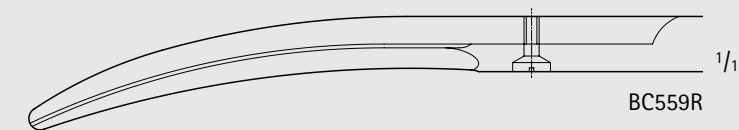
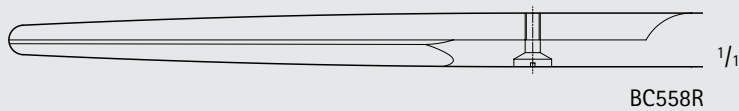

Cardiovascular

DUROTIP™ TC Scissors



Wavecut

■ Wavecut scissors have one serrated cutting edge to prevent tissue from slipping. The W after the item number indicates the scissors are the wavecut style, e.g. BC211W.

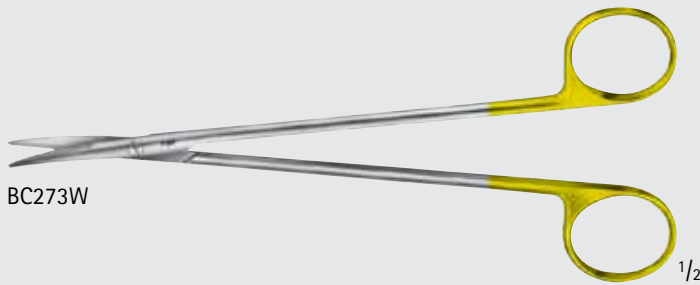

BC273W

1/2

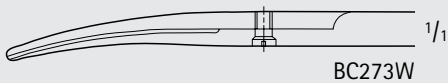

BC273W

1/1

DUROTIP TC TOENNIS-ADSON Wavecut Dissecting Scissors

Catalog Number	Tip	Blade	Length (in.)
BC273W	B/B	CVD	6 7/8



BC259W

1/2

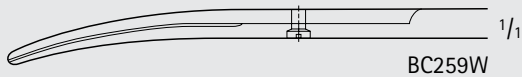

BC259W

1/1

DUROTIP TC Baby METZENBAUM Wavecut Dissecting Scissors, Delicate

Catalog Number	Tip	Blade	Length (in.)
BC259W	B/B	CVD	5 3/4

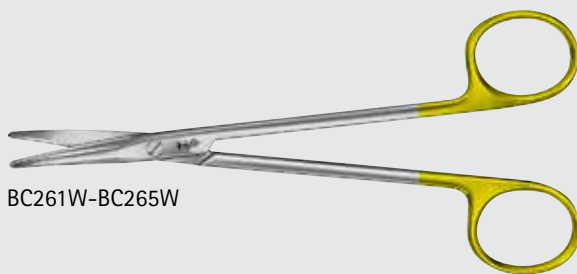

BC261W-BC265W

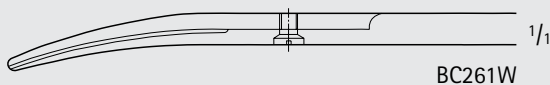

BC261W

1/1

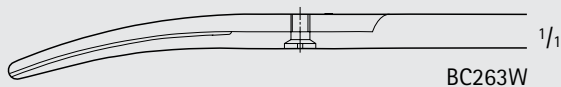

BC263W

1/1

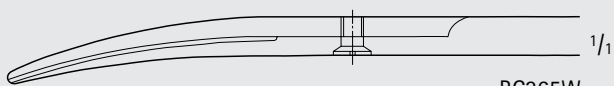

BC265W

1/1

DUROTIP TC METZENBAUM Wavecut Dissecting Scissors

Catalog Number	Tip	Blade	Length (in.)
BC261W	B/B	CVD	5 3/4
BC263W	B/B	CVD	7
BC265W	B/B	CVD	7 7/8

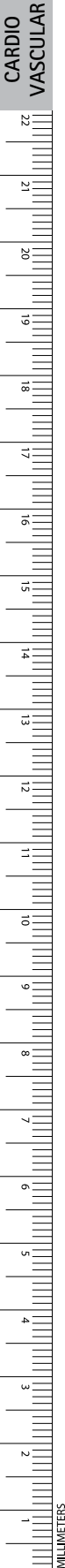

Cardiovascular

DUROTIP™ TC Scissors

CARDIO
VASCULAR



DUROTIP TC NELSON-METZENBAUM Wavecut Dissecting Scissors

Catalog Number	Tip	Blade	Length (in.)
BC267W	B/B	CVD	9
BC279W	B/B	CVD	10 1/4
BC281W	B/B	CVD	11

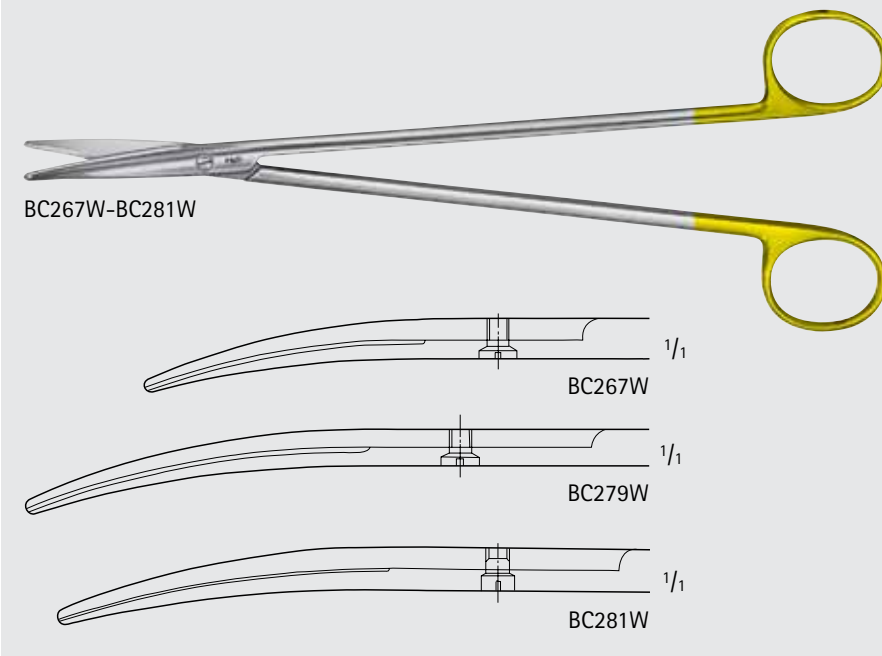

DUROTIP TC METZENBAUM Wavecut Dissecting Scissors, Delicate

Catalog Number	Tip	Blade	Length (in.)
BC271W	B/B	CVD	7
BC275W	B/B	CVD	7 7/8
BC277W	B/B	CVD	9

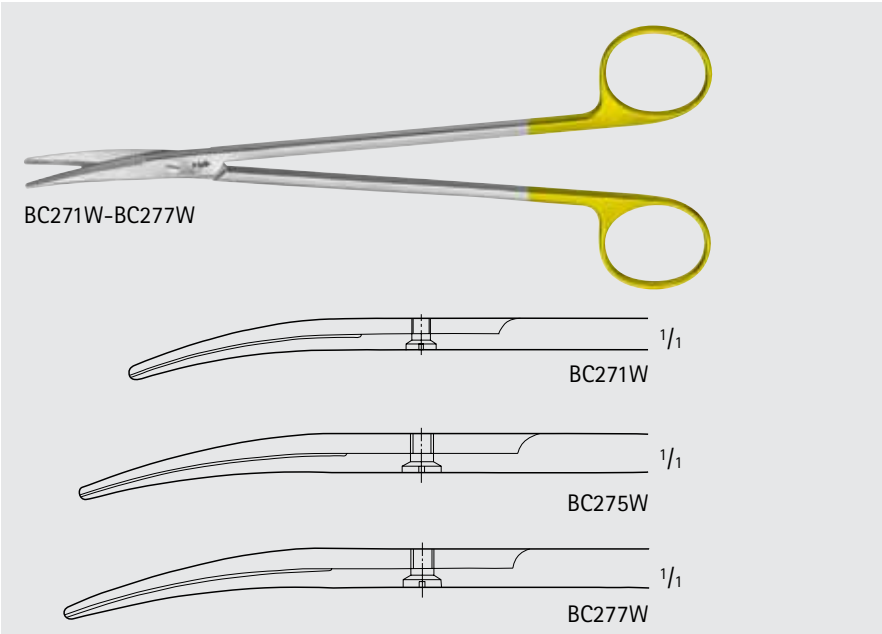

DUROTIP TC METZENBAUM Wavecut Dissecting Scissors, Heavy

Catalog Number	Tip	Blade	Length (in.)
BC287W	B/B	CVD	9

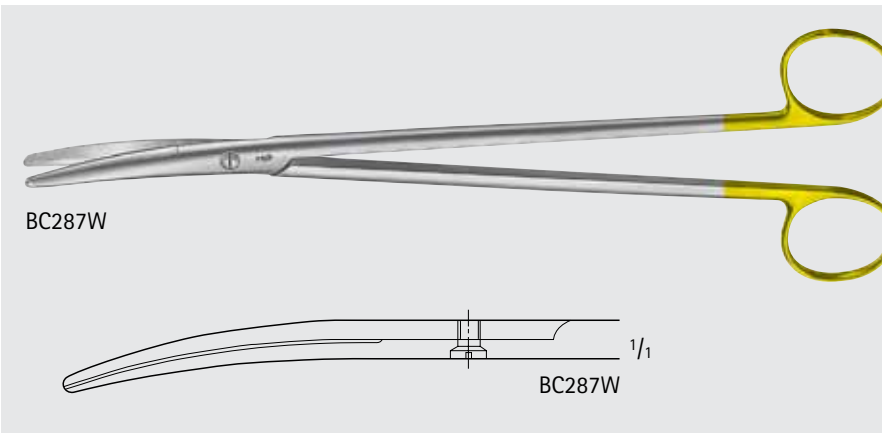

INCHES

Cardiovascular

DUROTIP™ TC Scissors

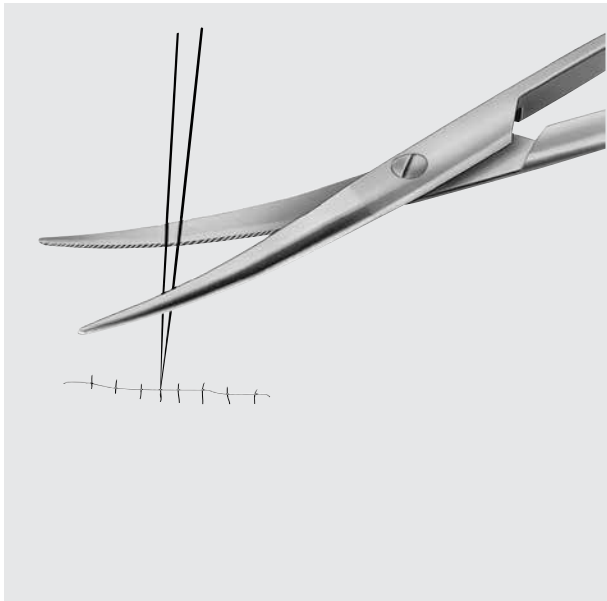

DUROTIP TC Ligature Scissors

- Carbide inserts help ensure sharp cutting edge (also in the distal area of the blades).
- Wavecut helps prevent suture materials from slipping.
- Identified by 1 gold-plated ring.



BC294W-BC298W

DUROTIP TC Ligature Wavecut Scissors

Catalog Number	Tip	Blade	Length (in.)
BC294W	B/B	CVD	5 3/4
BC295W	B/B	CVD	7
BC296W	B/B	CVD	9
BC297W	B/B	CVD	10 1/4
BC298W	B/B	CVD	13 3/4

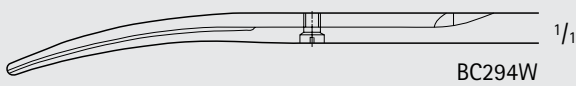

BC294W

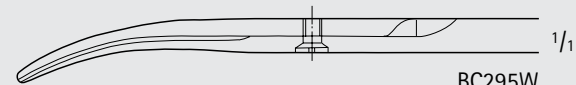

BC295W

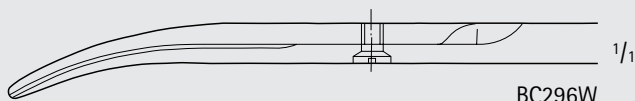

BC296W

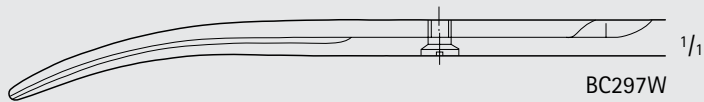

BC297W

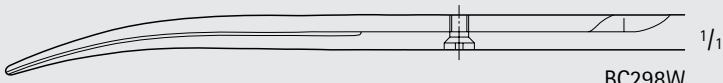

BC298W

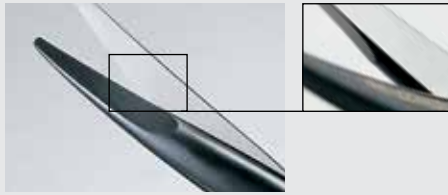

Microtome Edge

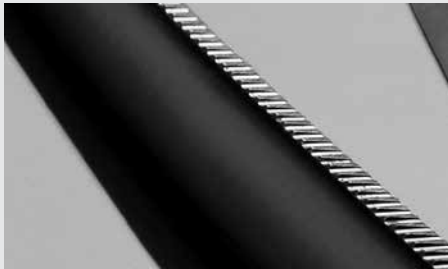

Wavecut

Noir Supreme Cut Scissors

■ Noir

The combination of the renowned Aesculap Tungsten Carbide technology with the Aesculap Noir coating results in an extremely high surface hardness and therefore high wear resistance in daily hospital use.

■ Microtome edge

The extremely sharp cutting edge of the scissors blade facilitates gentle cutting of tissue with minimal use of force.

■ Wavecut helps prevent tissue from slipping out during the cutting process.

■ The WB after the item number indicates the Noir scissors are the wavecut style, e.g. BC211WB.

For more information about Noir Supreme Cut Scissors see our brochure number DOC637.



BC252B-BC253WB

1/2



1/1

BC252B



1/1

BC253B, BC253WB

Noir MAYO Dissecting Scissors

Catalog Number	Tip	Blade	Length (in.)
BC252B	B/B	STR	6 3/4
BC253B	B/B	CVD	6 3/4
BC253WB	B/B	CVD	6 3/4



BC284B-BC284WB

1/2



1/1

BC284B-BC284WB

Noir MAYO-LEXER Dissecting Scissors

Catalog Number	Tip	Blade	Length (in.)
BC284B	B/B	CVD	6 1/2
BC284WB	B/B	CVD	6 1/2

Cardiovascular

Noir™ Supreme Cut Scissors





BC283B-BC283WB 1/2



BC283B-BC283WB 1/1

Noir LEXER Dissecting Scissors

Catalog Number	Tip	Blade	Length (in.)
BC283B	B/B	DEL, CVD	6 1/2
BC283WB	B/B	DEL, CVD	6 1/2



BC210B-BC211WB 1/2



BC210B 1/1



BC211B, BC211WB 1/1

Noir Iris Dissecting Scissors

Catalog Number	Tip	Blade	Length (in.)
BC210B	S/S	STR	4 1/4
BC211B	S/S	CVD	4 1/4
BC211WB	S/S	CVD	4 1/4



BC273B-BC273WB 1/2



BC273B-BC273WB 1/1

Noir TOENNIS-ADSON Dissecting Scissors

Catalog Number	Tip	Blade	Length (in.)
BC273B	B/B	DEL, CVD	6 7/8
BC273WB	B/B	DEL, CVD	6 7/8

Cardiovascular

Noir™ Supreme Cut Scissors

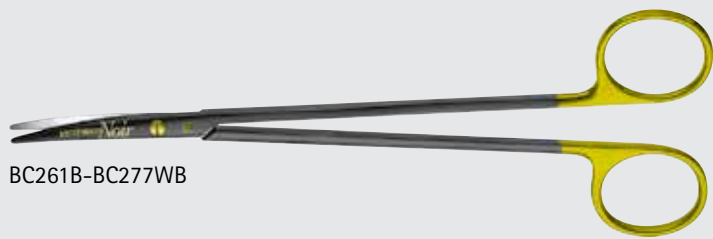

BC261B-BC277WB



BC261B, BC261WB



BC263B, BC263WB

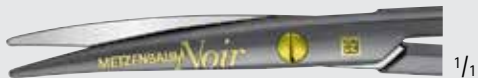

BC271B, BC271WB



BC265B, BC265WB



BC275B, BC275WB



BC267B, BC267WB



BC277B, BC277WB

Noir METZENBAUM Dissecting Scissors

Catalog Number	Tip	Blade	Length (in.)
BC261B	B/B	CVD	5 3/4
BC261WB	B/B	CVD	5 3/4
BC263B	B/B	CVD	7
BC263WB	B/B	CVD	7
BC271B	B/B	DEL, CVD	7
BC271WB	B/B	DEL, CVD	7
BC265B	B/B	CVD	7 7/8
BC265WB	B/B	CVD	7 7/8
BC275B	B/B	DEL, CVD	7 7/8
BC275WB	B/B	DEL, CVD	7 7/8
BC267B	B/B	CVD	9
BC267WB	B/B	CVD	9
BC277B	B/B	DEL, CVD	9
BC277WB	B/B	DEL, CVD	9



INCHES

Cardiovascular

Noir™ Supreme Cut Scissors

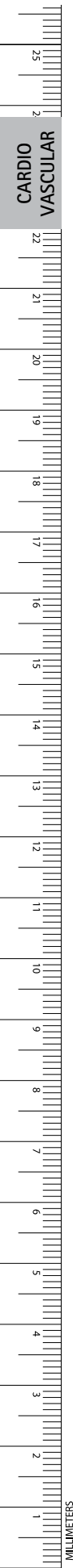

CARDIO
VASCULAR

Noir NELSON-METZENBAUM Dissecting Scissors

Catalog Number	Tip	Blade	Length (in.)
BC279B	B/B	DEL, CVD	10 1/4
BC279WB	B/B	DEL, CVD	10 1/4
BC281B	B/B	DEL, CVD	11
BC281WB	B/B	DEL, CVD	11

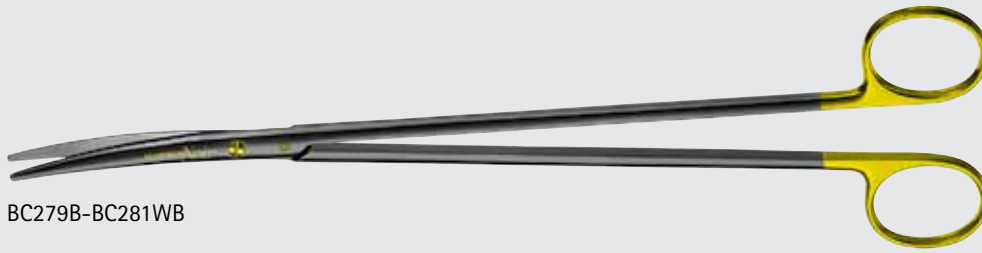

BC279B-BC281WB



BC279B, BC279WB



BC281B, BC281WB



FD020R-FD021R

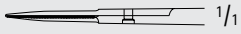

FD020R



FD021R

MILLESI Micro Scissors

Catalog Number	Tip	Blade	Handle	Length (in.)
FD020R	S/S	STR, SERR	FLAT, SERR	6 1/4
FD021R	S/S	CVD, SERR	FLAT, SERR	6 1/4

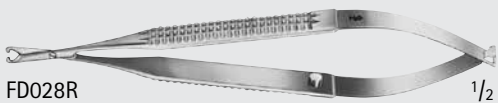

FD028R

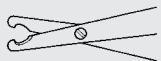
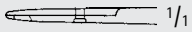

FD028R

MILLESI Micro Scissors

Catalog Number	Tip	Blade	Handle	Length (in.)
FD020R	S/S	STR, SERR	FLAT, SERR	6 1/4
FD021R	S/S	CVD, SERR	FLAT, SERR	6 1/4

BIEMER Vein Scissors

Catalog Number	Blade	Handle	Length (in.)
FD028R	STR	FLAT, SERR	5 1/8

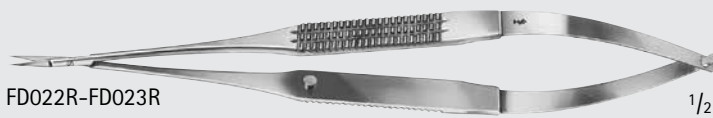

FD022R-FD023R

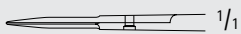

FD022R

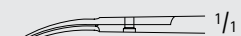

FD023R

YASARGIL Micro Vessel Scissors

Catalog Number	Blade	Handle	Length (in.)
FD022R	STR	FLAT, SERR	7 1/4
FD023R	CVD	FLAT, SERR	7 1/4

Cardiovascular

Micro Scissors

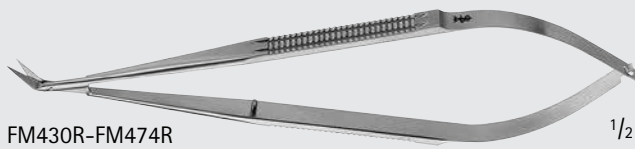
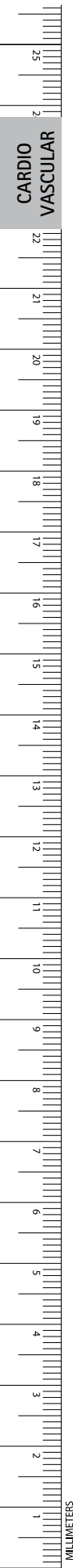

Blade: STR

Blade: 25°

Blade: 45°



Blade: CVD

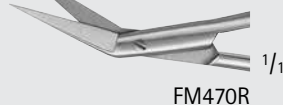

Blade: 60°

Blade: 90°

Blade: 125°

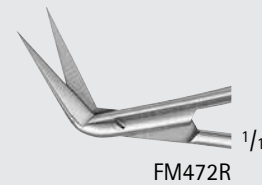

Micro Scissors, Flat Handle

Catalog Number	Tip	Blade	Blade Angle	Blade Length (mm)	Length (in.)
FM444R	S/S	X-DEL	STR	7	6 1/2
FM430R	S/S	X-DEL	CVD	7	6 1/2
FM431R	S/S	X-DEL	25°	7	6 1/2
FM432R	S/S	X-DEL	45°	7	6 1/2
FM433R	S/S	X-DEL	60°	7	6 1/2
FM434R	S/S	X-DEL	90°	7	6 1/2
FM435R	S/S	X-DEL	125°	7	6 1/2
FM442R	S/S	DEL	STR	10	6 1/2
FM436R	S/S	DEL	CVD	10	6 1/2
FM437R	S/S	DEL	25°	10	6 1/2
FM438R	S/S	DEL	45°	10	6 1/2
FM439R	S/S	DEL	60°	10	6 1/2
FM440R	S/S	DEL	90°	10	6 1/2
FM441R	S/S	DEL	125°	10	6 1/2
FM451R	S/1 BALL-PT	FINE	25°	15	6 1/2
FM452R	S/1 BALL-PT	FINE	45°	15	6 1/2
FM453R	S/1 BALL-PT	FINE	60°	15	6 1/2
FM454R	S/1 BALL-PT	FINE	90°	15	6 1/2
FM455R	S/1 BALL-PT	FINE	125°	15	6 1/2
FM470R	S/S	FINE	25°	15	6 1/2
FM471R	S/S	FINE	45°	15	6 1/2
FM472R	S/S	FINE	60°	15	6 1/2
FM473R	S/S	FINE	90°	15	6 1/2
FM474R	S/S	FINE	125°	15	6 1/2

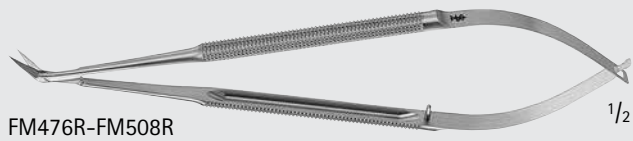

Blade: STR



Blade: 25°



Blade: 45°



Blade: CVD



Blade: 60°



Blade: 90°



Blade: 125°

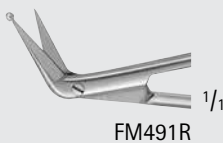
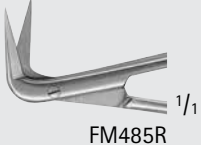

Micro Scissors, Round Handle

Catalog Number	Tip	Blade	Blade Angle	Blade Length (mm)	Length (in.)
FM503R	S/S	X-DEL	CVD	7	6 1/2
FM504R	S/S	X-DEL	25°	7	6 1/2
FM505R	S/S	X-DEL	45°	7	6 1/2
FM506R	S/S	X-DEL	60°	7	6 1/2
FM507R	S/S	X-DEL	90°	7	6 1/2
FM508R	S/S	X-DEL	125°	7	6 1/2
FM488R	S/S	DEL	STR	10	6 1/2
FM481R	S/S	DEL	CVD	10	6 1/2
FM482R	S/S	DEL	25°	10	6 1/2
FM483R	S/S	DEL	45°	10	6 1/2
FM484R	S/S	DEL	60°	10	6 1/2
FM485R	S/S	DEL	90°	10	6 1/2
FM486R	S/S	DEL	125°	10	6 1/2
FM489R	S/1 BALL-PT	DEL	25°	10	6 1/2
FM490R	S/1 BALL-PT	DEL	45°	10	6 1/2
FM491R	S/1 BALL-PT	DEL	60°	10	6 1/2
FM492R	S/1 BALL-PT	DEL	90°	10	6 1/2
FM493R	S/1 BALL-PT	DEL	125°	10	6 1/2
FM476R	S/S	FINE	25°	15	6 1/2
FM477R	S/S	FINE	45°	15	6 1/2
FM478R	S/S	FINE	60°	15	6 1/2
FM479R	S/S	FINE	90°	15	6 1/2
FM480R	S/S	FINE	125°	15	6 1/2



Cardiovascular

Special CV Scissors



FD056R-FD057R

NAGEL Micro Scissors

Catalog Number	Tip	Blade	Length (in.)
FD056R	S/S	45°	7 7/8
FD057R	PROBE	45°	7 7/8

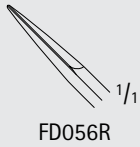

FD056R

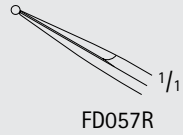

FD057R



FD059R

DEBAKEY Circumflex Micro Scissors

Catalog Number	Tip	Blade	Length (in.)
FD059R	S/S	125°	7 1/2



FD059R



FD100R-FD103R

Micro Scissors

Catalog Number	Tip	Blade	Handle	Length (in.)
FD100R	S/S	STR	ROUND	5 3/4
FD101R	S/S	CVD	ROUND	5 3/4
FD103R	B/B	CVD	ROUND	5 3/4

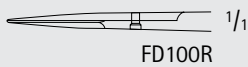

FD100R

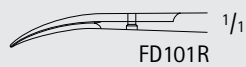

FD101R

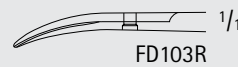

FD103R

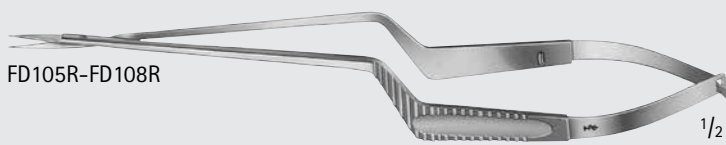

FD105R-FD108R

Micro Vessel Scissors

Catalog Number	Tip	Blade	Length (in.)
FD105R	S/S	STR	7 1/2
FD106R	S/S	CVD	7 1/2
FD107R	S/S	DEL, STR	7 1/2
FD108R	S/S	DEL, CVD	7 1/2

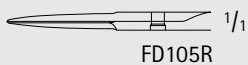

FD105R

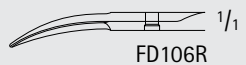

FD106R

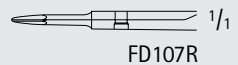

FD107R

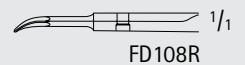

FD108R



Cardiovascular

Micro Needle Holders

CARDIO
VASCULAR

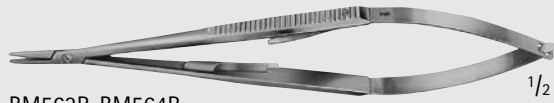

BM563R-BM564R

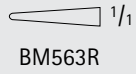

CASTROVIEJO Micro Needle Holder, W/ Catch

Catalog Number	Tip	Jaw	Length (in.)
BM563R	STR	SMOOTH	5 3/4
BM564R	CVD	SMOOTH	5 3/4



FD045R-FD046R

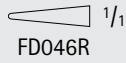
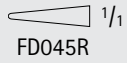

JACOBSON Micro Needle Holder

Catalog Number	Handle	Jaw	Length (in.)
FD045R	W/O CATCH	SMOOTH	7 1/4
FD046R	W/ CATCH	SMOOTH	7 1/4

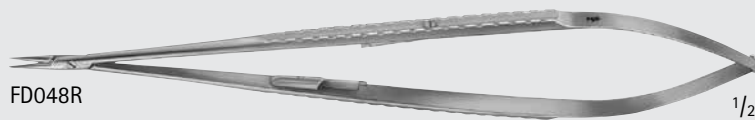

FD048R



Micro Needle Holder, W/ Catch

Catalog Number	Jaw	Length (in.)
FD048R	SMOOTH	7 7/8



FD076R-FD079R



Micro Needle Holder, W/O Catch

Catalog Number	Tip	Jaw	Length (in.)
FD076R	STR	SMOOTH	6 1/4
FD079R	CVD	SMOOTH	6 1/4

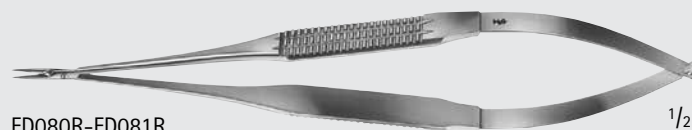

FD080R-FD081R



Micro Needle Holder, W/O Catch

Catalog Number	Tip	Jaw	Length (in.)
FD080R	STR	SMOOTH	7 1/4
FD081R	CVD	SMOOTH	7 1/4

INCHES

Cardiovascular

Micro Needle Holders

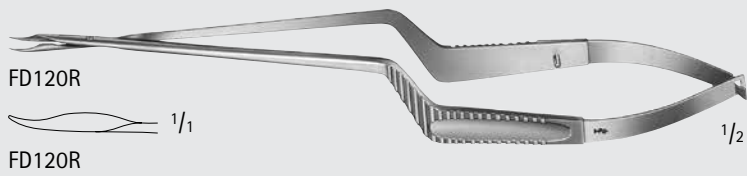

Micro Needle Holder, Bayonet-Shaped

Catalog Number	Tip	Length (in.)
FD120R	CVD-UP	7 3/4

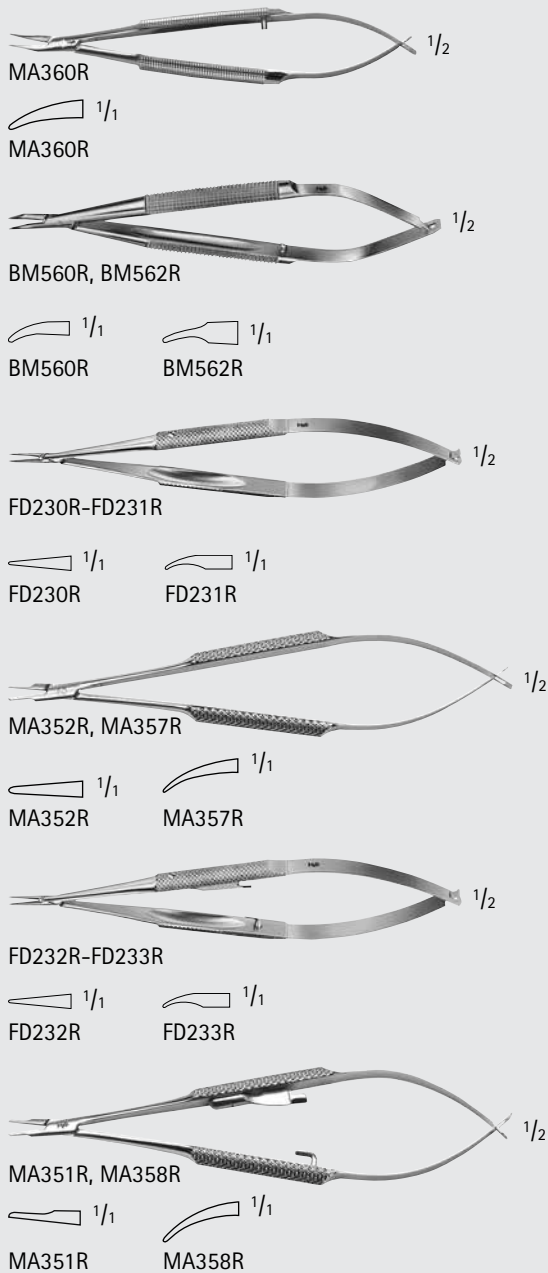

BARRAQUER Micro Needle Holder, Round Knurled Handle

Catalog Number	Tip	Handle	Length (in.)
FD230R	STR	W/O CATCH	4 3/4
MA352R	STR	W/O CATCH	5 1/4
BM562R	CVD, DEL	W/O CATCH	4 3/4
MA360R	CVD	W/O CATCH	4 1/4
BM560R	CVD	W/O CATCH	4 1/2
FD231R	CVD	W/O CATCH	4 3/4
MA357R	CVD	W/O CATCH	5 1/4
FD232R	STR	W/ CATCH	4 3/4
MA351R	STR	W/ CATCH	5 1/4
FD233R	CVD	W/ CATCH	4 3/4
MA358R	CVD	W/ CATCH	5 1/4

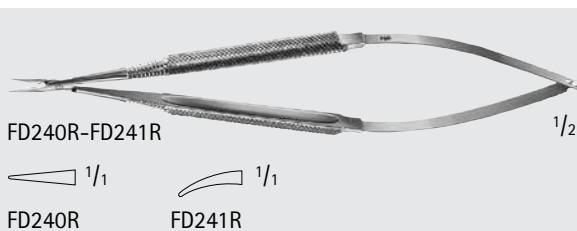

REILL Micro Needle Holder, W/O Catch

Catalog Number	Tip	Jaw	Length (in.)
FD240R	STR	SMOOTH	6
FD241R	CVD	SMOOTH	6



Cardiovascular Micro Needle Holders



FD242R-FD243R

1/2



FD242R

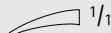

FD243R

Micro Needle Holder, Round Knurled Handle W/ Catch

Catalog Number	Tip	Jaw	Length (in.)
FD242R	STR	SMOOTH	6
FD243R	CVD	SMOOTH	6



FD244R-FD245R

1/2



FD244R

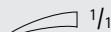

FD245R

Micro Needle Holder, Round Knurled Handle W/O Catch

Catalog Number	Tip	Jaw	Length (in.)
FD244R	STR	SMOOTH	7 1/4
FD245R	CVD	SMOOTH	7 1/4

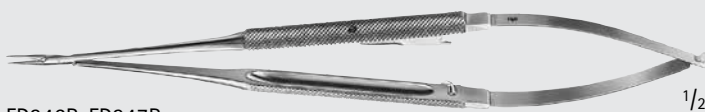

FD246R-FD247R

1/2

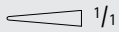

FD246R

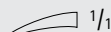

FD247R

Micro Needle Holder, Round Knurled Handle W/ Catch

Catalog Number	Tip	Jaw	Length (in.)
FD246R	STR	SMOOTH	7 1/4
FD247R	CVD	SMOOTH	7 1/4



FM392R

1/2

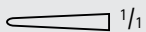

FM392R

Round Knurled Handle Micro Needle Holder, W/ Catch

Catalog Number	Tip	Jaw	Length (in.)
FM392R	STR	SMOOTH	9



FM021R

1/2



FM021R

MUELLER Micro Needle Holder, Plastic Handle W/ Catch

Catalog Number	Tip	Length (in.)
FM021R	CVD	5 3/4



INCHES

Cardiovascular

DUROGRIP™ TC Micro Needle Holders

Aesculap features Needle Holders with Tungsten Carbide (TC) inserts. A smooth jaw and three different serration patterns are available, depending on the size of the suture needle.

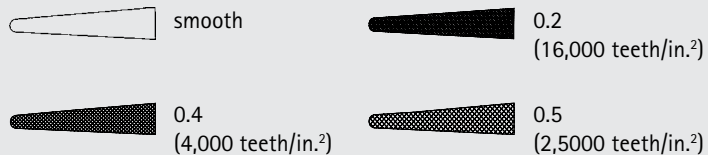
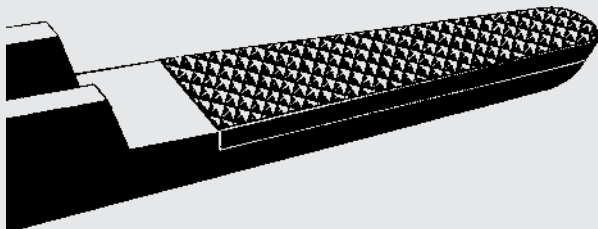

We recommend carbide inserts as follows:

Jaw Surface	Suture Material
Smooth	9/0 - 11/0
0.2 mm pitch of serration	6/0 - 10/0
0.4 mm pitch of serration	4/0 - 6/0
0.5 mm pitch of serration	up to 3/0

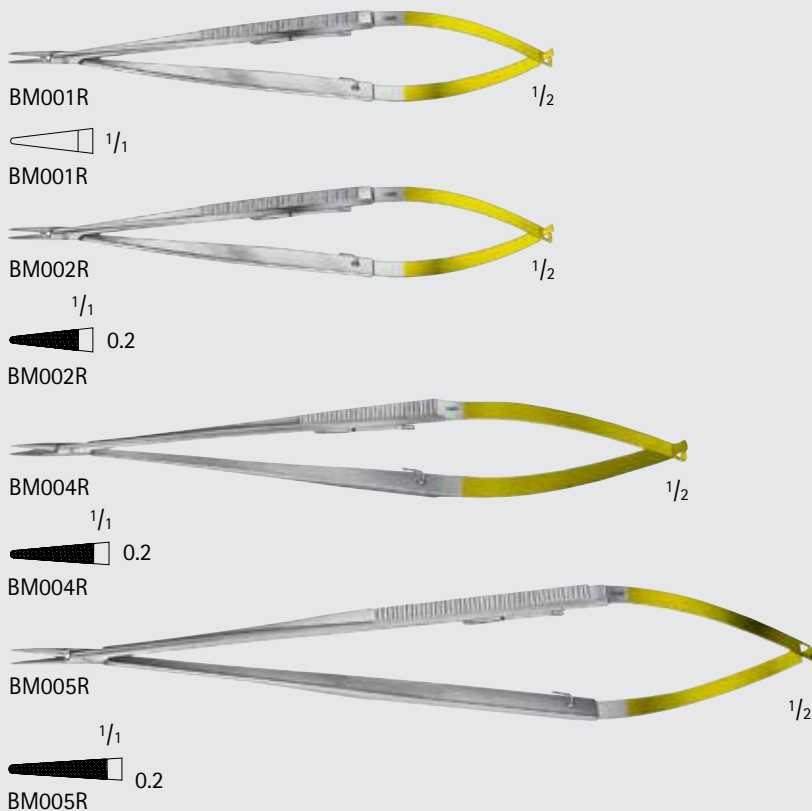

DUROGRIP TC CASTROVIEJO Micro Needle Holder, Flat Handle

Catalog Number	Jaw	Length (in.)
BM001R	SMOOTH	5 3/4
BM002R	SERR	5 3/4
BM004R	SERR	7
BM005R	SERR	8 1/2

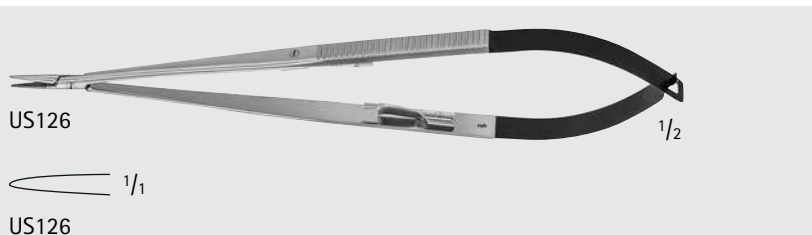

DUROGRIP TC SPENCER Coronary Needle Holder

Catalog Number	Jaw	Length (in.)
US126	SMOOTH	7



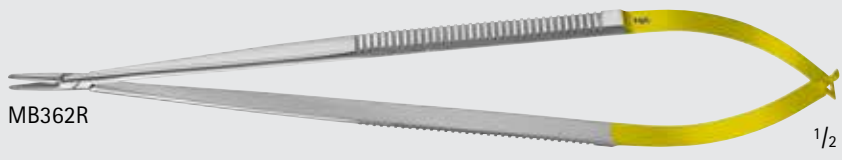



MB362R 1/2

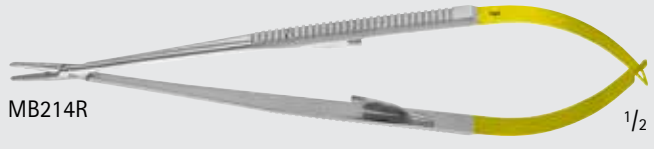

MB362R

Catalog Number	Jaw	Length (in.)
MB362R	SERR	8 3/4



MB214R 1/2

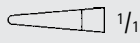

MB214R

Catalog Number	Jaw	Length (in.)
MB214R	SMOOTH	7 1/4



MB215R 1/2

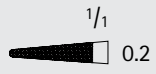

MB215R

Catalog Number	Jaw	Length (in.)
MB215R	SERR	8



FM388R-FM390R



FM388R



FM390R

Catalog Number	Jaw	Length (in.)
FM388R	SERR	7
FM390R	SERR	7 7/8

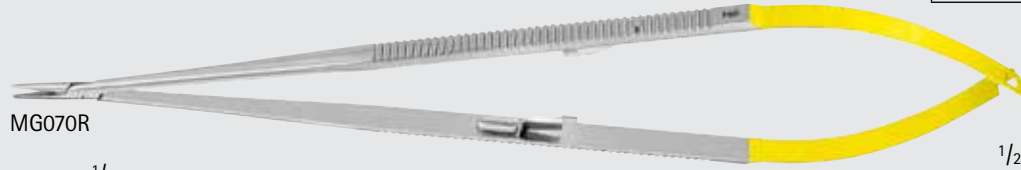

MG070R 1/2



MG070R

Catalog Number	Jaw	Length (in.)
MG070R	SERR	10 1/2

Cardiovascular

Dia Dust™ Micro Needle Holders



■ Dia Dust diamond dust coating ensures an even harder and more wear resistant surface on the inside of the jaws. The structure of the Dia Dust coating enables a reliable grip for fine needles, sutures, and tissue.



FM540R-FM544R



FM540R



FM541R-FM544R

Dia Dust Micro Needle Holder, Flat Handle W/ Catch

Catalog Number	Tip	Suture Size	Length (in.)
FM540R	STR	7/0 AND SMALLER	6 3/4
FM541R	STR	5/0 AND SMALLER	5 3/4
FM542R	STR	5/0 AND SMALLER	7 1/4
FM543R	STR	5/0 AND SMALLER	8 1/4
FM544R	STR	5/0 AND SMALLER	9



FM545R-FM549R



FM545R-FM549R

1/2

Dia Dust Micro Needle Holder, Flat Handle W/O Catch

Catalog Number	Tip	Suture Size	Length (in.)
FM545R	STR	7/0 AND SMALLER	6 3/4
FM546R	STR	5/0 AND SMALLER	5 3/4
FM547R	STR	5/0 AND SMALLER	7 1/4
FM548R	STR	5/0 AND SMALLER	8 1/4
FM549R	STR	5/0 AND SMALLER	9

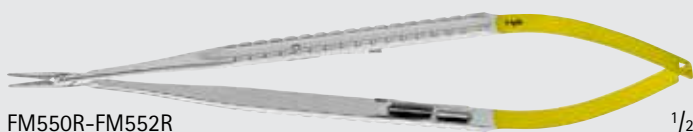

FM550R-FM552R



FM550R-FM552R

1/2

Dia Dust Micro Needle Holder, Flat Knurled Handle W/ Catch

Catalog Number	Tip	Suture Size	Length (in.)
FM550R	STR	5/0 AND SMALLER	7 1/4
FM551R	STR	5/0 AND SMALLER	8 1/4
FM552R	STR	5/0 AND SMALLER	9



Cardiovascular

Dia Dust™ Micro Needle Holders

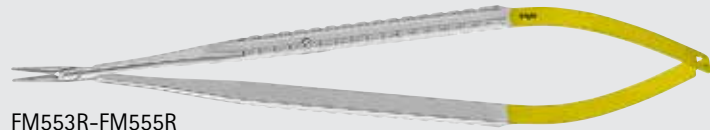

FM553R-FM555R



FM553R-FM555R

Dia Dust Micro Needle Holder, Flat Knurled Handle W/O Catch

Catalog Number	Tip	Suture Size	Length (in.)
FM553R	STR	5/0 AND SMALLER	7 1/4
FM554R	STR	5/0 AND SMALLER	8 1/4
FM555R	STR	5/0 AND SMALLER	9

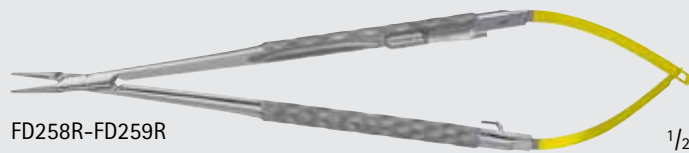

FD258R-FD259R



FD258R



FD259R

Dia Dust Micro Needle Holder, Golf Ball Handle Design

Catalog Number	Tip	Suture Size	Length (in.)
FD258R	STR	7/0 AND SMALLER	7
FD259R	CVD	7/0 AND SMALLER	7

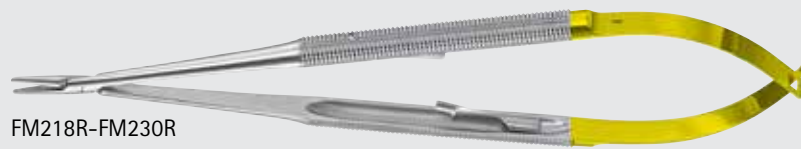

FM218R-FM230R



FM218R-FM230R



FM221R-FM223R



FM221R-FM223R

Dia Dust Micro Needle Holder, Round Handle W/ Catch

Catalog Number	Tip	Suture Size	Length (in.)
FM218R	STR	4/0 AND SMALLER	7 1/4
FM228R	STR	4/0 AND SMALLER	8 1/4
FM230R	STR	4/0 AND SMALLER	9
FM221R	CVD	4/0 AND SMALLER	8 1/4
FM223R	CVD	4/0 AND SMALLER	9

Cardiovascular

Dia Dust™ Micro Needle Holders

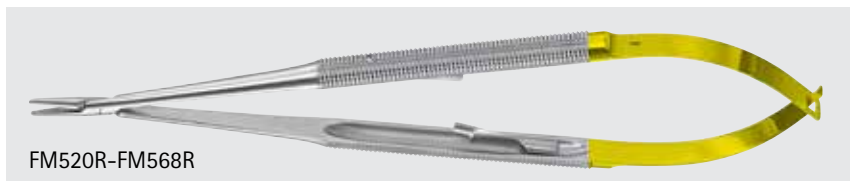
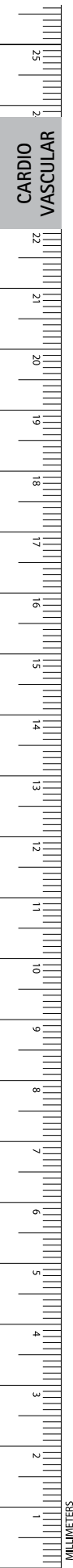

FM520R-FM568R



FM520R, FM521R, FM563R, FM565R, FM567R



FM522R, FM523R, FM564R, FM566R, FM568R

Dia Dust Micro Needle Holder, Round Handle W/ Catch

Catalog Number	Tip	Suture Size	Length (in.)
FM520R	STR	7/0 AND SMALLER	4 3/4
FM521R	STR	7/0 AND SMALLER	6 1/4
FM563R	STR	7/0 AND SMALLER	7 1/4
FM565R	STR	7/0 AND SMALLER	8 1/4
FM567R	STR	7/0 AND SMALLER	9
FM522R	STR	5/0 AND SMALLER	5 3/4
FM523R	STR	5/0 AND SMALLER	6 1/4
FM564R	STR	5/0 AND SMALLER	7 1/4
FM566R	STR	5/0 AND SMALLER	8 1/4
FM568R	STR	5/0 AND SMALLER	9



FM524R-FM533R



FM524R-FM527R, FM532R



FM528R-FM531R, FM533R

Dia Dust Micro Needle Holder, Round Handle W/O Catch

Catalog Number	Tip	Suture Size	Length (in.)
FM524R	STR	7/0 AND SMALLER	4 3/4
FM525R	STR	7/0 AND SMALLER	6 1/4
FM526R	STR	7/0 AND SMALLER	7 1/4
FM527R	STR	7/0 AND SMALLER	8 1/4
FM532R	STR	7/0 AND SMALLER	9
FM528R	STR	5/0 AND SMALLER	5 3/4
FM529R	STR	5/0 AND SMALLER	6 1/4
FM530R	STR	5/0 AND SMALLER	7 1/4
FM531R	STR	5/0 AND SMALLER	8 1/4
FM533R	STR	5/0 AND SMALLER	9



FM236R



1/2

Dia Dust Micro Needle Holder, Round Handle W/ Catch

Catalog Number	Tip	Suture Size	Length (in.)
FM236R	STR	5/0 AND SMALLER	8 1/4

Cardiovascular

Dia Dust™ Micro Needle Holders



FM276R

1/1

FM276R

1/2

Dia Dust Micro Needle Holder, Round Handle W/O Catch

Catalog Number	Tip	Suture Size	Length (in.)
FM276R	STR	5/0 AND SMALLER	8 1/4

FM534R-FM539R

1/1

FM534R-FM539R

1/2

Dia Dust Micro Needle Holder, Round Handle, Heavy, W/ Catch

Catalog Number	Tip	Description	Length (in.)
FM538R	STR	2/0 AND SMALLER	7 1/2
FM539R	STR	2/0 AND SMALLER	9
FM534R	STR	2/0 AND SMALLER	9 3/4

FM535R-FM537R

1/1

FM535R-FM537R

1/2

Dia Dust Micro Needle Holder, Round Handle, Heavy, W/O Catch

Catalog Number	Tip	Suture Size	Length (in.)
FM535R	STR	2/0 AND SMALLER	7 1/2
FM536R	STR	2/0 AND SMALLER	9
FM537R	STR	2/0 AND SMALLER	9 3/4

FM560R

1/1

FM560R

1/2

FM561R

1/1

FM561R

1/2

Dia Dust GLASSER Micro Needle Holder, Round Handle W/ Catch

Catalog Number	Tip	Suture Size	Length (in.)
FM560R	STR	5/0 AND SMALLER	5
FM561R	STR	5/0 AND SMALLER	7

Cardiovascular

Titanium Micro Needle Holders

Aesculap Titanium Micro Instruments

- The extremely light Titanium material is an advantage for lengthy cardiac and vascular operations. This helps to carry on operating over longer time periods with minimum fatigue.
- The non-magnetic material makes working with particularly fine needles easier for you.
- Non-reflecting surface finish.
- Incomparable operating sensitivity: the Aesculap golf ball handle design.
- Unmistakable identification: the Aesculap color code.

For more information about Titanium Micro Instruments see our brochure number DOC890.



All needle holder jaws are coated with Aesculap Dia Dust™ diamond dust coating. This coating ensures that the inner surfaces provide the best possible performance in hardness and wear resistance. The texture of the jaws greatly increases its surface area, allowing you to grasp fine needles, sutures and soft tissue safely and securely. The needle quickly aligns itself in an ideal position in the rough surface. This results in a perfect grip that quite simply prevents any needle slippage.

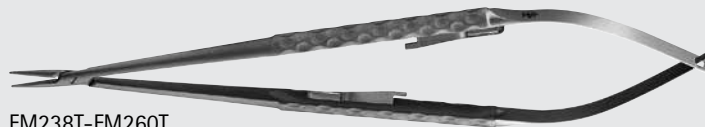

FM238T-FM260T



FM258T-FM260T



FM238T-FM240T

Titanium Micro Needle Holder, Golf Ball Handle Design W/ Catch

Catalog Number	Tip	Suture Size	Handle Color	Length (in.)
FM258T	STR	7/0 AND SMALLER	GREEN	7 1/4
FM259T	STR	7/0 AND SMALLER	GREEN	8 1/4
FM260T	STR	7/0 AND SMALLER	GREEN	9
FM238T	STR	5/0 AND SMALLER	BLUE	7 1/4
FM239T	STR	5/0 AND SMALLER	BLUE	8 1/4
FM240T	STR	5/0 AND SMALLER	BLUE	9

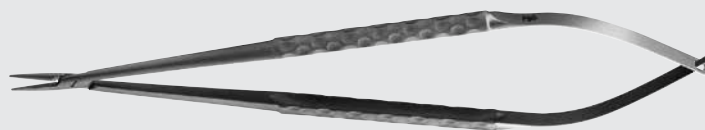

FM232T-FM254T



FM252T-FM254T



FM232T-FM234T

Titanium Micro Needle Holder, Golf Ball Handle Design W/O Catch

Catalog Number	Tip	Suture Size	Handle Color	Length (in.)
FM252T	STR	7/0 AND SMALLER	GREEN	7 1/4
FM253T	STR	7/0 AND SMALLER	GREEN	8 1/4
FM254T	STR	7/0 AND SMALLER	GREEN	9
FM232T	STR	5/0 AND SMALLER	BLUE	7 1/4
FM233T	STR	5/0 AND SMALLER	BLUE	8 1/4
FM234T	STR	5/0 AND SMALLER	BLUE	9

CARDIO VASCULAR

MILLIMETERS



Dia Dust RYDER Needle Holder

Catalog Number	Tip	Suture Size	Length (in.)
BM301R	X-DEL	5/0 AND SMALLER	5 1/2
BM302R	X-DEL	5/0 AND SMALLER	7
BM325R	X-DEL	5/0 AND SMALLER	6 1/4
BM327R	X-DEL	5/0 AND SMALLER	8 3/4
BM328R	X-DEL	5/0 AND SMALLER	9 3/4

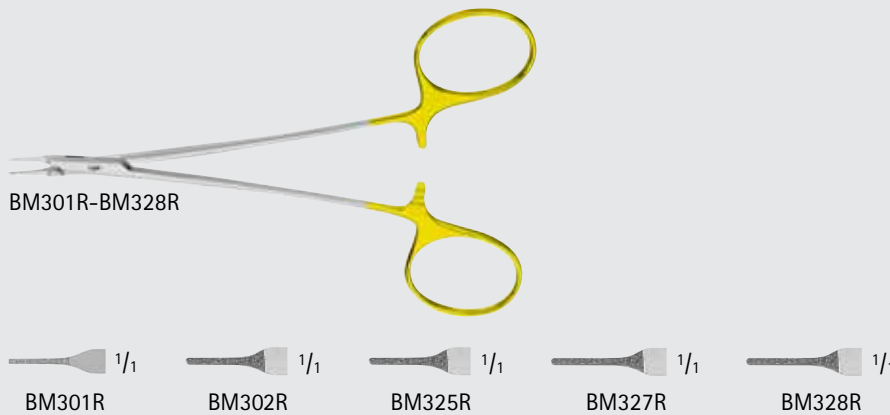

Titanium Dia Dust RYDER Needle Holder

Catalog Number	Tip	Suture Size	Length (in.)
BM385T	X-DEL	5/0 AND SMALLER	6 1/4
BM386T	X-DEL	5/0 AND SMALLER	7
BM387T	X-DEL	5/0 AND SMALLER	8 1/4

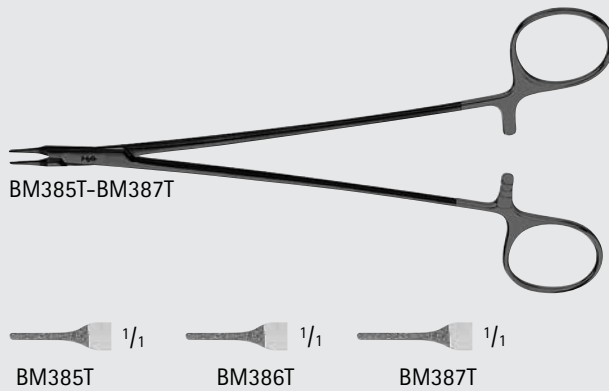

DUROGRIP TC DEBAKEY Needle Holder, Offset

Catalog Number	Jaw	Length (in.)
BM051R	SERR	7 3/4
BM052R	SERR	9 5/8

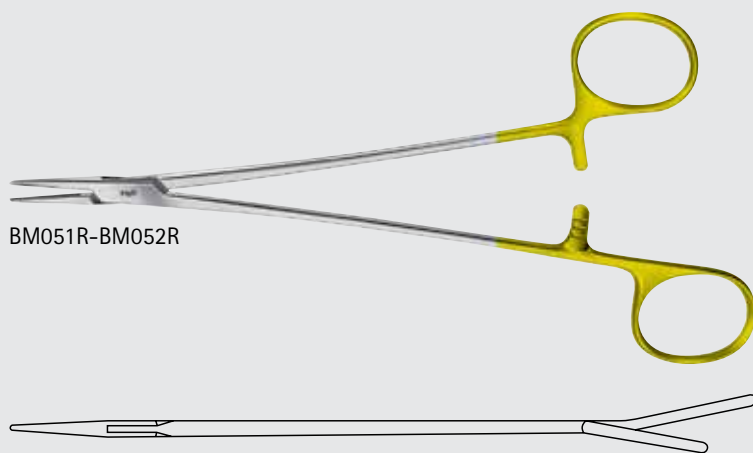

DUROGRIP TC Microvascular Needle Holder

Catalog Number	Jaw	Length (in.)
MG071R	SERR	6

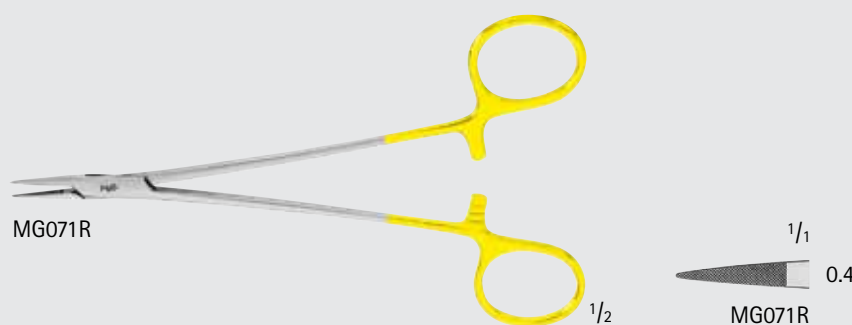

Cardiovascular

DUROGRIP™ TC Needle Holders

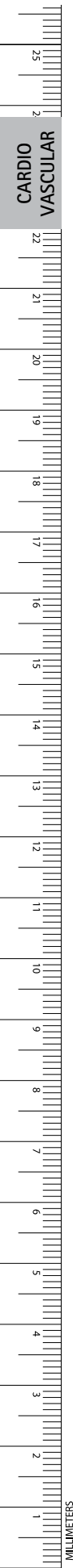

CARDIO
VASCULAR

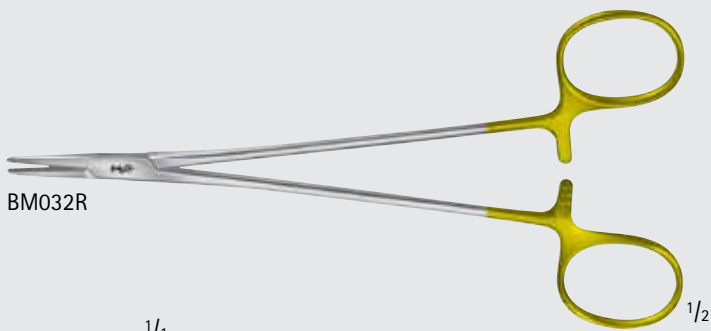

BM032R

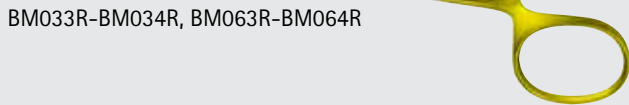
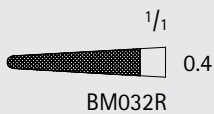

BM033R-BM034R, BM063R-BM064R



BM033R



BM034R



BM063R

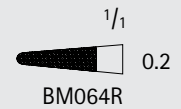

BM064R

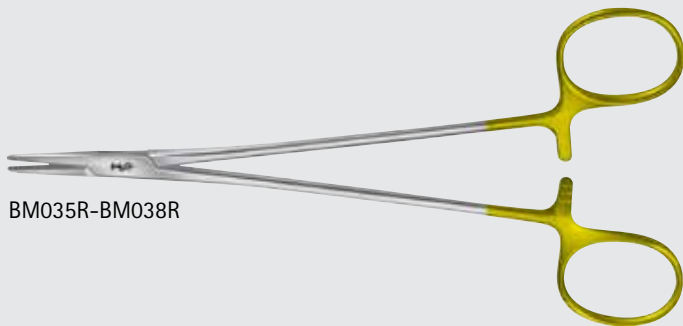

BM035R-BM038R

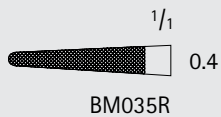

BM035R

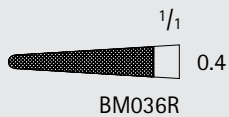

BM036R

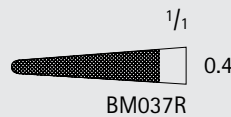

BM037R

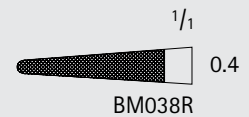

BM038R

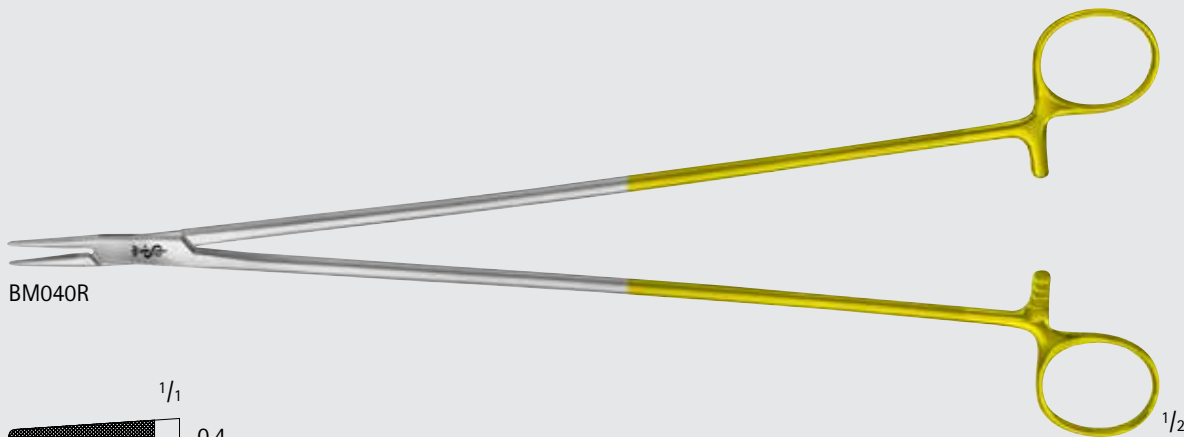

BM040R

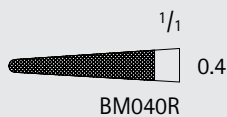

BM040R

DUROGRIP TC DEBAKEY Needle Holder

Catalog Number	Tip	Jaw	Length (in.)
BM032R	DEL	SERR	6
BM033R	DEL	SERR	6 1/2
BM035R	DEL	SERR	7
BM034R	DEL	SERR	8 1/4
BM036R	DEL	SERR	9
BM037R	DEL	SERR	10 1/4
BM038R	DEL	SERR	12
BM063R	X-DEL	SERR	6 1/2
BM064R	X-DEL	SERR	8 1/4
BM040R	X-DEL	SERR	12

Cardiovascular

DUROGRIP™ TC Needle Holders

DUROGRIP TC RYDER Needle Holder

Catalog Number	Tip	Jaw	Length (in.)
BM054R	X-DEL	SERR	5 1/4
BM055R	X-DEL	SERR	6 1/8
BM056R	X-DEL	SERR	6 7/8
BM057R	X-DEL	SERR	8 1/4
BM058R	X-DEL	SERR	9
BM044R	DEL	SERR	5 1/4
BM045R	DEL	SERR	6 7/8
BM046R	DEL	SERR	7 3/4
BM047R	DEL	SERR	10 1/2
BM074R	DEL	SMOOTH	6
BM075R	DEL	SMOOTH	7
BM076R	DEL	SMOOTH	8 7/8

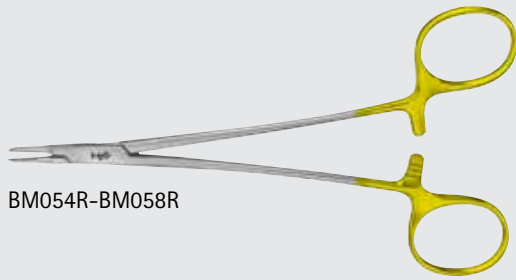

BM054R-BM058R

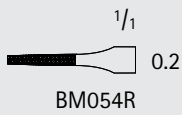

BM054R



BM055R

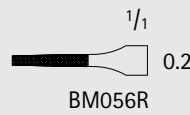

BM056R

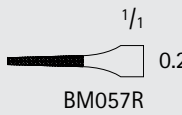

BM057R

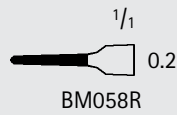

BM058R

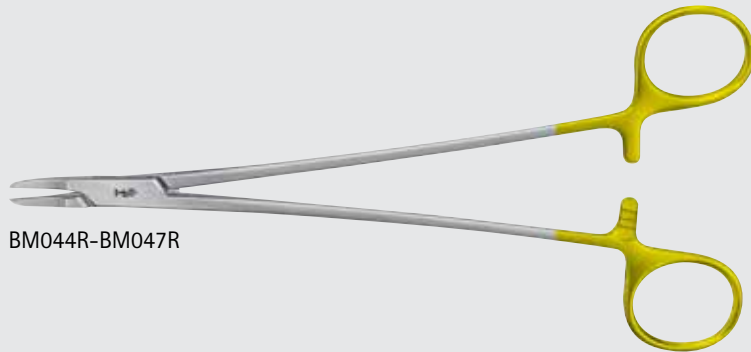

BM044R-BM047R

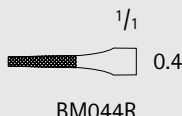

BM044R



BM045R

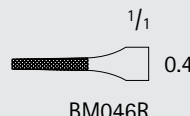

BM046R

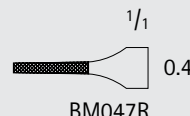

BM047R

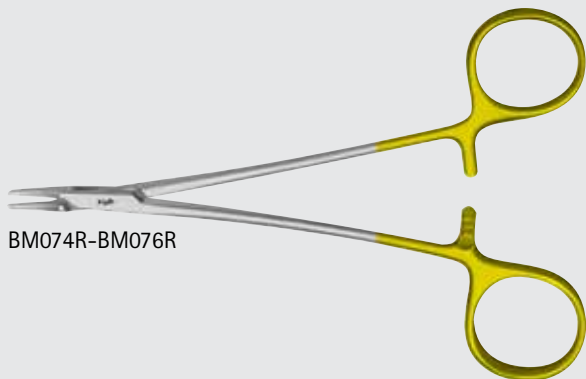

BM074R-BM076R

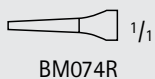

BM074R

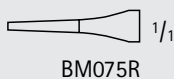

BM075R

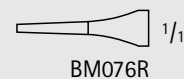

BM076R

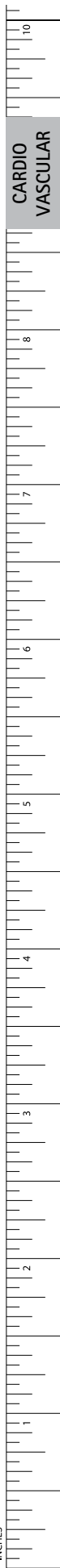

Cardiovascular

DUROGRIP™ TC Needle Holders

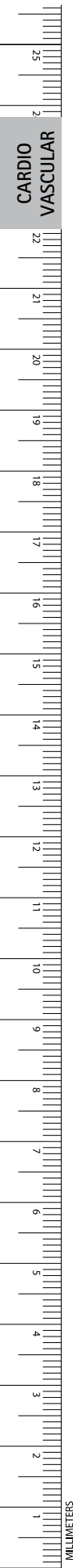

CARDIO
VASCULAR

BM095R-BM096R

1/1
0.5
BM095R

1/1
0.5
BM096R

Catalog Number	Tip	Jaw	Length (in.)
BM095R	CVD	SERR	8 1/4
BM096R	CVD	SERR	9

MB210R

1/1
MB210R

Catalog Number	Jaw	Length (in.)
MB210R	SERR	9

DEBAKEY Tissue Forceps

Catalog Number	Tip Size (mm)	Length (in.)
MB062R	2	14
MB915R	2	16
MB916R	3	16



MB062R-MB916R

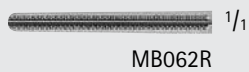

WHEELER Vessel Forceps

Catalog Number	Tip	Length (in.)
MG440R	SERR	6



GERALD Dressing Forceps, Delicate

Catalog Number	Tip	Jaw	Length (in.)
BD228R	STR	SERR	6 7/8
BD230R	STR	SERR	9
BD229R	CVD	SERR	6 7/8

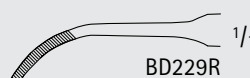
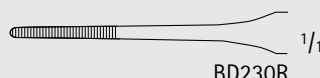
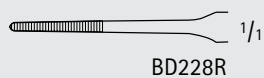

GERALD Tissue Forceps, Delicate

Catalog Number	Tip	Teeth	Length (in.)
BD662R	STR	1 x 2	6 7/8
BD664R	STR	1 x 2	9
BD663R	CVD	1 x 2	6 7/8

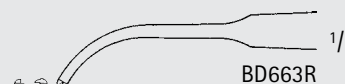
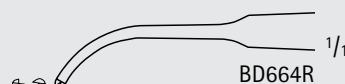
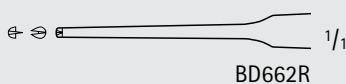

SELMAN Tissue Forceps

Catalog Number	Length (in.)
BD750R	6 1/8
MB795R	7 7/8
MG078R	9 3/4

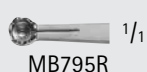
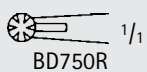

Cardiovascular

Forceps

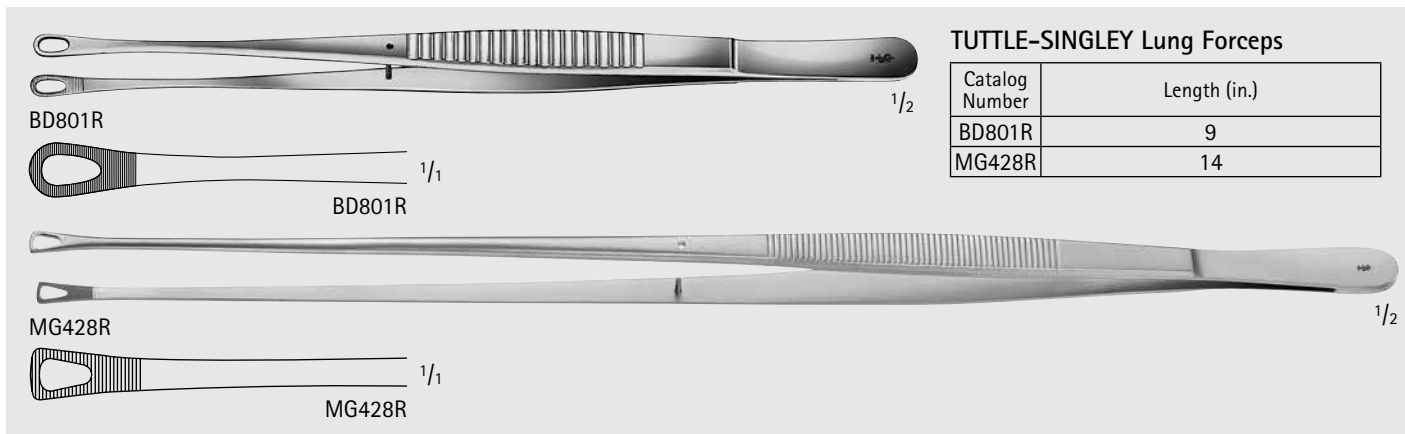
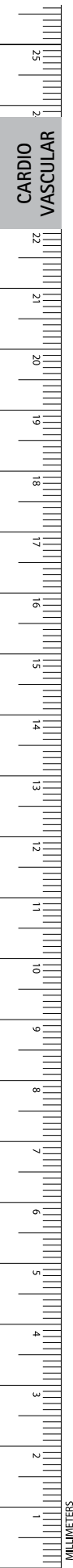

TUTTLE-SINGLEY Lung Forceps

Catalog Number	Length (in.)
BD801R	9
MG428R	14

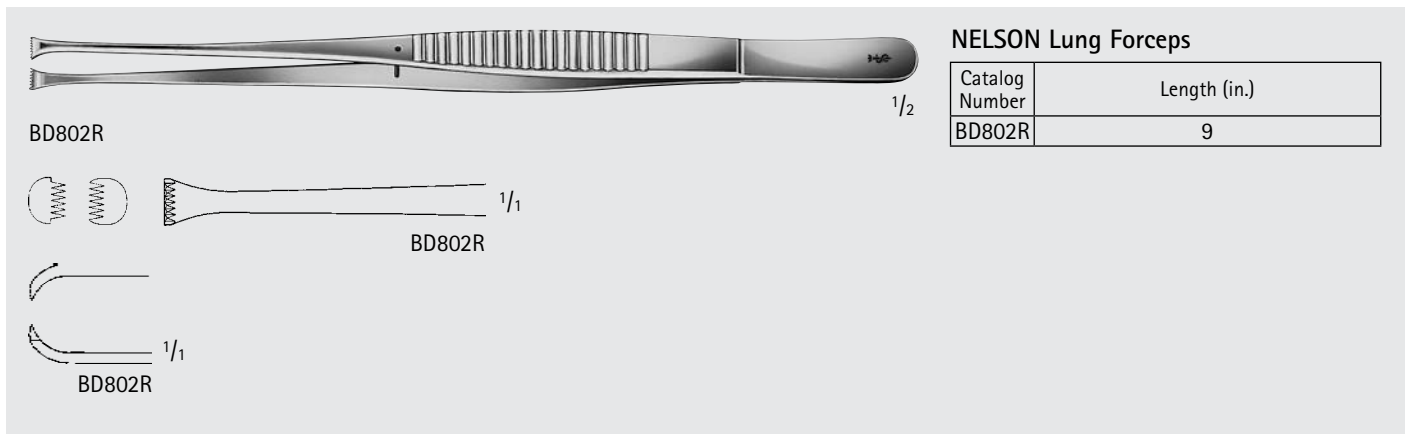

NELSON Lung Forceps

Catalog Number	Length (in.)
BD802R	9

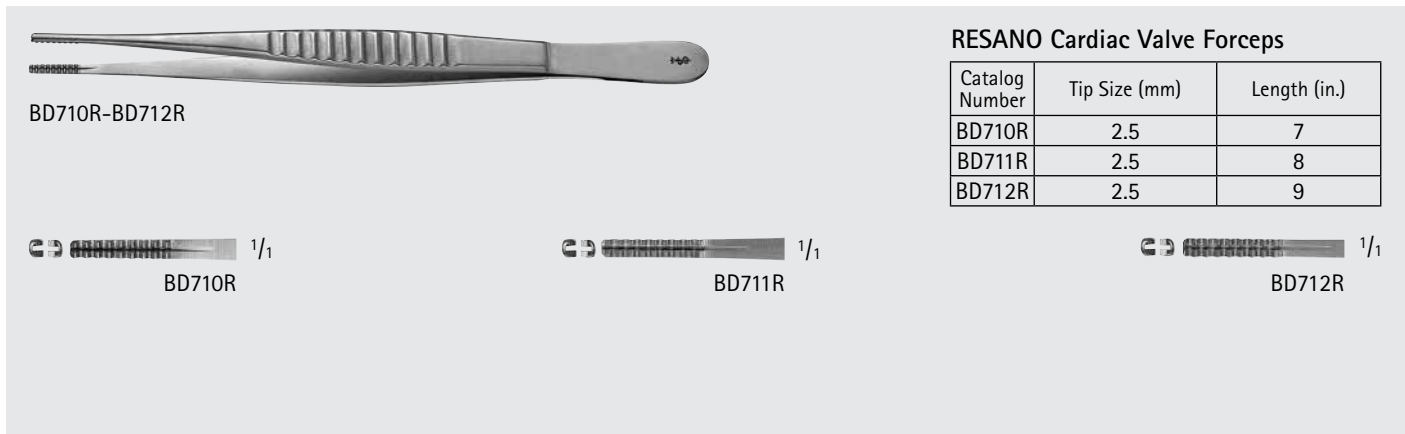

RESANO Cardiac Valve Forceps

Catalog Number	Tip Size (mm)	Length (in.)
BD710R	2.5	7
BD711R	2.5	8
BD712R	2.5	9

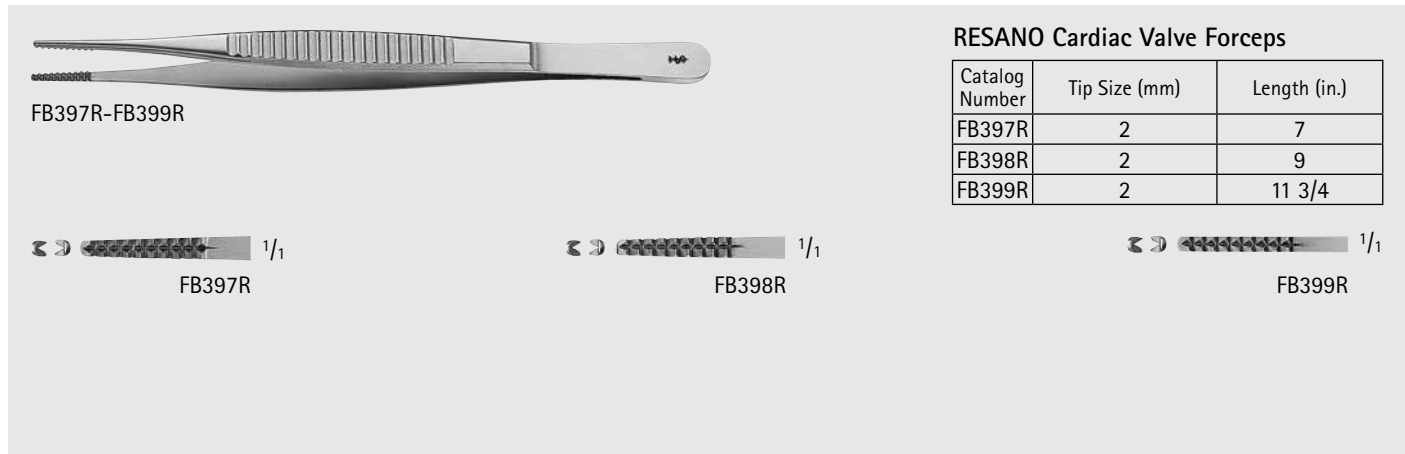

RESANO Cardiac Valve Forceps

Catalog Number	Tip Size (mm)	Length (in.)
FB397R	2	7
FB398R	2	9
FB399R	2	11 3/4

GERALD Micro Forceps, Flat Handle

Catalog Number	Tip	Length (in.)
BD190R	SERR	7
BD197R	SERR	9 3/4



BD190R-BD197R

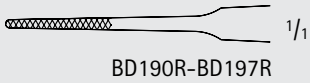

GERALD Micro Forceps, Flat Handle

Catalog Number	Tip	Length (in.)
BD191R	DEBAKEY	7
BD195R	DEBAKEY	7 7/8



BD191R-BD195R

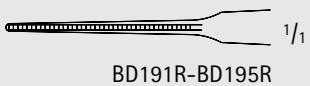

Micro Suture Forceps, W/ Platform

Catalog Number	Tip Size (mm)	Length (in.)
BD338R	0.3	4 3/4
BD264R	0.5	7 1/4



BD338R

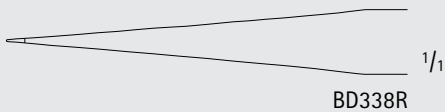

BD264R



MUELLER Micro Forceps, Plastic Handle

Catalog Number	Teeth	Length (in.)
FM033R	-	6 1/4
FM034R	1 x 2	6 1/4



FM033R

FM033R



FM034R

FM034R



INCHES

Cardiovascular

Forceps



FM035R



FM035R

MUELLER Micro Ring Forceps, Plastic Handle

Catalog Number	Diam. of Ring (mm)	Length (in.)
FM035R	1.2	6 1/4



FM036R



FM036R

MUELLER Micro Forceps, Plastic Handle, W/ Platform

Catalog Number	Length (in.)
FM036R	6 1/4



FM063R

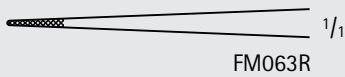

FM063R

Micro Forceps, Round Handle

Catalog Number	Tip	Counter-balance	Length (in.)
FM063R	CROSS-SERR	NO	7 7/8



FM590R-FM591R



FM590R

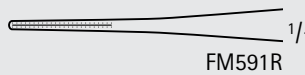

FM591R

Micro Forceps, Round Handle

Catalog Number	Tip	Counter-balance	Length (in.)
FM590R	DEBAKEY	NO	7 1/4
FM591R	DEBAKEY	NO	8 1/4
FM592R	DEBAKEY	YES	7 1/4
FM600R	DEBAKEY	YES	8 1/4



FM592R-FM600R

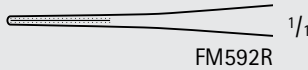

FM592R



FM600R



BD154R

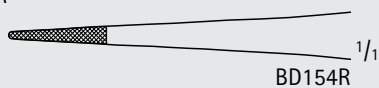

BD154R

DUROGRIP TC (POTTS-SMITH) Thumb Forceps

Catalog Number	Tip	Length (in.)
BD154R	X-SERR	5 3/4

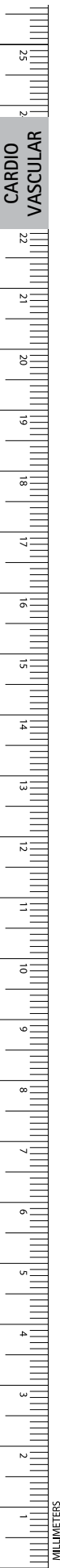



■ The Dia Dust diamond dust coating ensures an even harder and more wear resistant surface on the inside of the jaws. The structure of the Dia Dust coating enables a reliable grip for fine needles, sutures, and tissue.



BD192R-BD193R

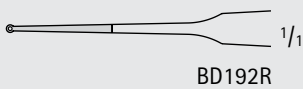

BD192R

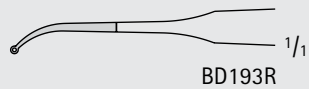

BD193R

Dia Dust GERALD Micro Ring Forceps, Flat Handle

Catalog Number	Diam. of Ring (mm)	Tip	Length (in.)
BD192R	1.0	STR	7
BD193R	1.0	CVD	7



BD194R-BD196R

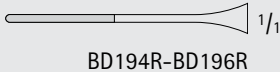

BD194R-BD196R

Dia Dust GERALD Micro Forceps, Flat Handle

Catalog Number	Tip	Tip Size (mm)	Length (in.)
BD194R	STR	1.0	7
BD196R	STR	1.0	7 7/8



BD200R-BD201R



BD200R-BD201R

Dia Dust THUMB Forceps, Flat Handle

Catalog Number	Tip	Tip Size (mm)	Length (in.)
BD200R	STR	1.0	7
BD201R	STR	1.0	8 1/4



FD253R



FD253R

Dia Dust Micro Forceps W/ Platform

Catalog Number	Tip	Counter-balance	Length (in.)
FD253R	STR	NO	7



INCHES

Cardiovascular

Dia Dust™ Forceps

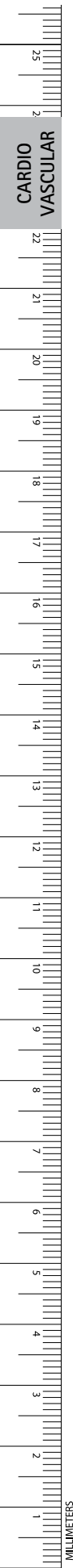

CARDIO
VASCULAR



FM053R-FM054R



FM053R-FM054R

Dia Dust Micro Ring Forceps, Round Handle

Catalog Number	Diam. of Ring (mm)	Tip	Counter-balance	Length (in.)
FM053R	2.5	STR	NO	7
FM054R	2.5	STR	NO	7 7/8



FM597R-FM598R

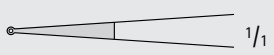

FM597R-FM598R



FM587R

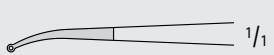

FM587R

Dia Dust Micro Ring Forceps, Round Handle

Catalog Number	Diam. of Ring (mm)	Tip	Counter-balance	Length (in.)
FM597R	1.0	STR	NO	7 1/4
FM598R	1.0	STR	NO	8 1/4
FM587R	1.0	CVD	NO	7 1/4



FM582R-FM584R



FM582R-FM584R

Dia Dust Micro Ring Forceps, W/ Platform, Round Handle

Catalog Number	Diam. of Ring (mm)	Tip	Counter-balance	Length (in.)
FM582R	1.0	STR	NO	7 1/4
FM584R	1.0	STR	NO	8 1/4



FM586R-FM588R



FM586R-FM588R

Dia Dust Micro Forceps, W/ Platform, Round Handle

Catalog Number	Tip	Counter-balance	Length (in.)
FM586R	STR	NO	7 1/4
FM588R	STR	NO	8 1/4

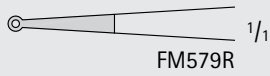
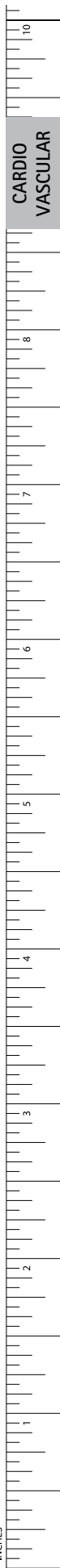

FM571R-FM595R

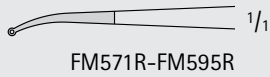

Dia Dust Micro Ring Forceps, Round Handle

Catalog Number	Diam. of Ring (mm)	Tip	Counter-balance	Length (in.)
FM570R	1.0	STR	YES	6
FM572R	1.0	STR	YES	7 1/4
FM574R	1.0	STR	YES	8 1/4
FM576R	1.0	STR	YES	9
FM596R	1.0	STR	YES	9 3/4
FM579R	2.0	STR	YES	7 1/4
FM571R	1.0	CVD	YES	6
FM573R	1.0	CVD	YES	7 1/4
FM575R	1.0	CVD	YES	8 1/4
FM577R	1.0	CVD	YES	9
FM595R	1.0	CVD	YES	9 3/4



FM578R-FM599R

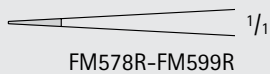

FM581R-FM593R

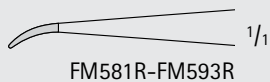

Dia Dust Micro Forceps, W/ Platform, Round Handle

Catalog Number	Tip	Counter-balance	Length (in.)
FM578R	STR	YES	6
FM580R	STR	YES	7 1/4
FM599R	STR	YES	8 1/4
FM594R	STR	YES	9 3/4
FM581R	CVD	YES	6
FM583R	CVD	YES	7 1/4
FM585R	CVD	YES	8 1/4
FM593R	CVD	YES	9 3/4

Cardiovascular

Titanium Forceps

Aesculap Titanium Micro Instruments

- The extremely light Titanium material is an advantage for lengthy cardiac and vascular operations. This helps to carry on operating over longer time periods with minimum fatigue.
- Non-reflecting surface finish - for optimal glare reduction.
- The Aesculap golf ball handle design - gives incomparable operating sensitivity.
- The Aesculap color code - provides unmistakable instrument identification.



All titanium forceps jaws are coated with Aesculap Dia Dust™ diamond dust coating. This coating ensures that the inner surfaces provide the best possible performance in hardness and wear resistance. The texture of the jaws greatly increases its surface area, allowing you to grasp sutures and soft tissue safely and securely.

For more information about Titanium Micro Instruments see our brochure number **DOC890**.



FM317T-FM319T

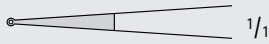

FM317T-FM319T

Titanium Micro Ring Forceps, Golf Ball Handle

Catalog Number	Diam. of Ring (mm)	Tip	Handle Color	Counter-balance	Length (in.)
FM317T	1.0	DIA DUST	BLUE	NO	7 1/4
FM318T	1.0	DIA DUST	BLUE	NO	8 1/4
FM319T	1.0	DIA DUST	BLUE	NO	9



FM327T-FM329T



FM327T-FM329T

Titanium Micro Forceps, W/ Platform, Golf Ball Handle

Catalog Number	Tip	Handle Color	Counter-balance	Length (in.)
FM327T	DIA DUST	GREEN	NO	7 1/4
FM328T	DIA DUST	GREEN	NO	8 1/4
FM329T	DIA DUST	GREEN	NO	9



FM337T-FM339T



FM337T-FM339T

Titanium Micro Forceps, Golf Ball Handle

Catalog Number	Tip	Handle Color	Counter-balance	Length (in.)
FM337T	DEBAKEY	PURPLE	NO	7 1/4
FM338T	DEBAKEY	PURPLE	NO	8 1/4
FM339T	DEBAKEY	PURPLE	NO	9

CARDIO
VASCULAR

MILLIMETERS



Titanium Standard Forceps

- Non-reflecting surface finish.
- Fatigue-free lightness.
- Blue handle for definite identification of an Aesculap Titanium Instrument.

For more information about Titanium forceps see our brochure number **DOC890**.

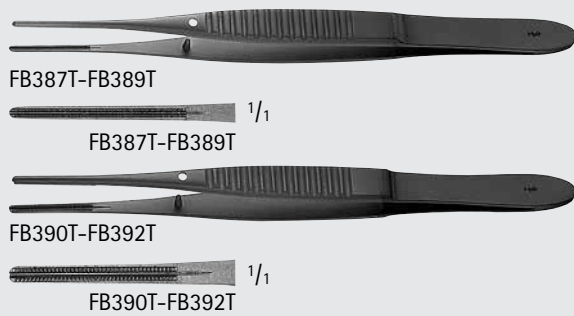

Titanium DEBAKEY Atraumatic Forceps

Catalog Number	Tip Size (mm)	Length (in.)
FB387T	1.5	5 3/4
FB388T	1.5	7 3/4
FB389T	1.5	9 1/2
FB390T	2.5	5 3/4
FB391T	2.5	7 3/4
FB392T	2.5	9 1/2



Titanium Micro ADSON Dissecting Forceps

Catalog Number	Tip	Length (in.)
BD221T	SERR	4 3/4



Titanium Micro ADSON Tissue Forceps, Delicate

Catalog Number	Tip	Teeth	Length (in.)
BD514T	SERR	1 x 2	4 3/4

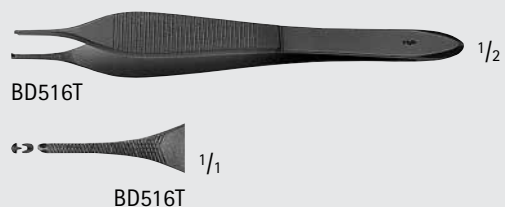

Titanium Micro ADSON Tissue Forceps

Catalog Number	Tip	Teeth	Length (in.)
BD516T	SERR	1 x 2	4 3/4

Cardiovascular

Titanium Forceps

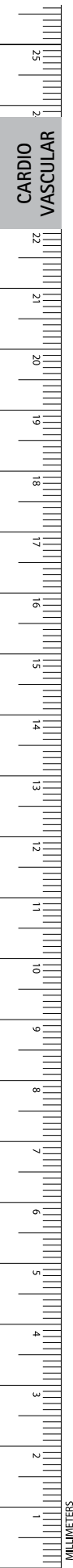

CARDIO
VASCULAR



BD227T

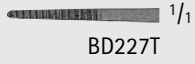

BD227T

Titanium GERALD Dissecting Forceps, Delicate

Catalog Number	Tip	Length (in.)
BD227T	SERR	6 3/4



BD657T

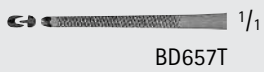

BD657T

Titanium GERALD Tissue Forceps

Catalog Number	Tip	Teeth	Length (in.)
BD657T	SERR	1 x 2	6 3/4



BD715T



BD715T

Titanium RESANO Grasping Forceps

Catalog Number	Tip	Length (in.)
BD715T	SERR	9



Titanium Ringhandled Instruments

- Non-reflecting surface finish.
- Fatigue-free lightness.
- Blue rings for definite identification of an Aesculap Titanium Instrument.

For more information about Titanium Ringhandled Instruments see our brochure number DOC890.

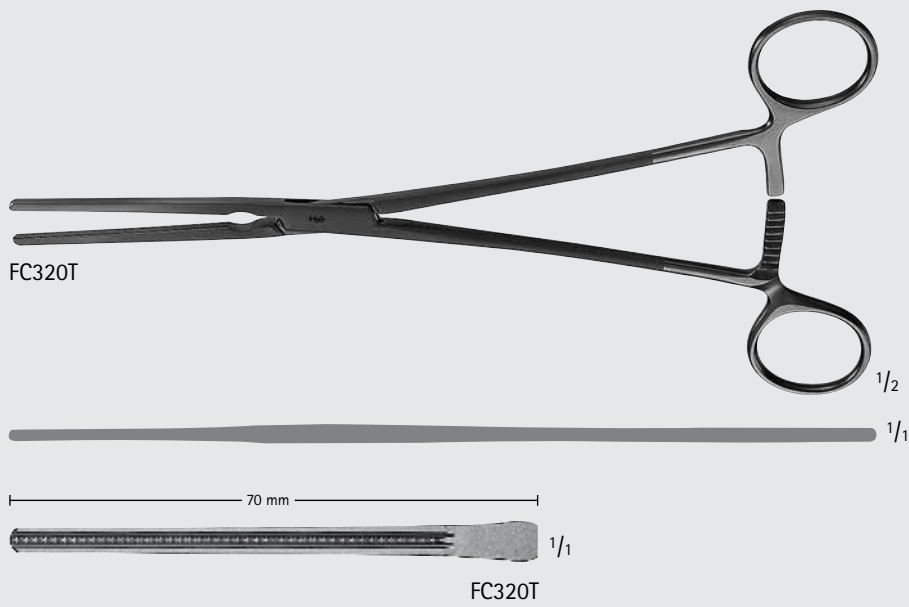

Titanium DEBAKEY Atraumatic Vascular Clamp

Catalog Number	Jaw	Jaw Length (mm)	Length (in.)
FC320T	STR	70	9

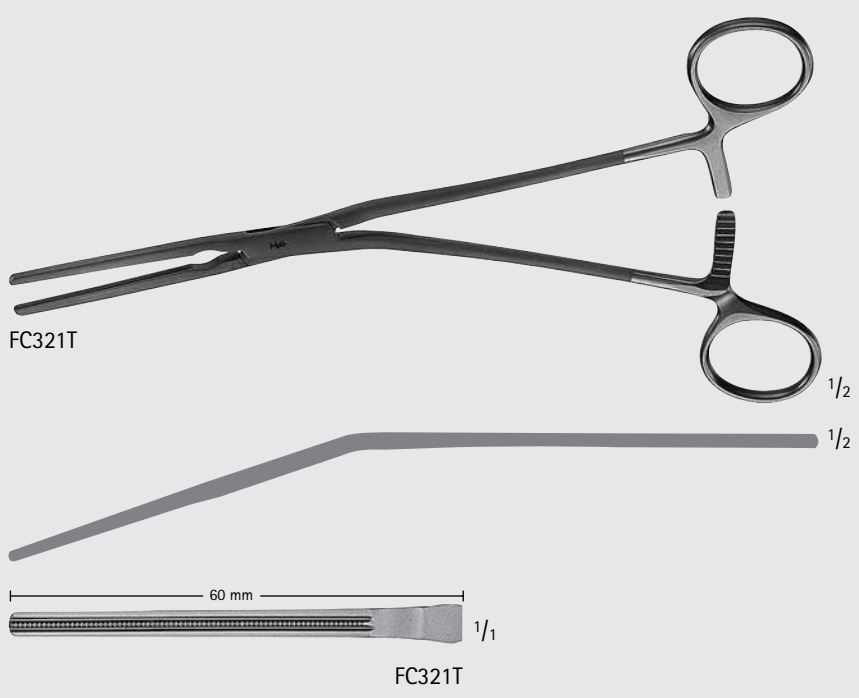

Titanium DEBAKEY Atraumatic Vascular Clamp

Catalog Number	Jaw	Jaw Length (mm)	Shaft	Length (in.)
FC321T	STR	60	ANG	8 1/2

Cardiovascular

Titanium Clamps



FC322T-FC323T

Titanium DEBAKEY Atraumatic Vascular Clamp

Catalog Number	Jaw	Jaw Length (mm)	Length (in.)
FC322T	CVD	70	8 7/8
FC323T	CVD	75	9 5/8

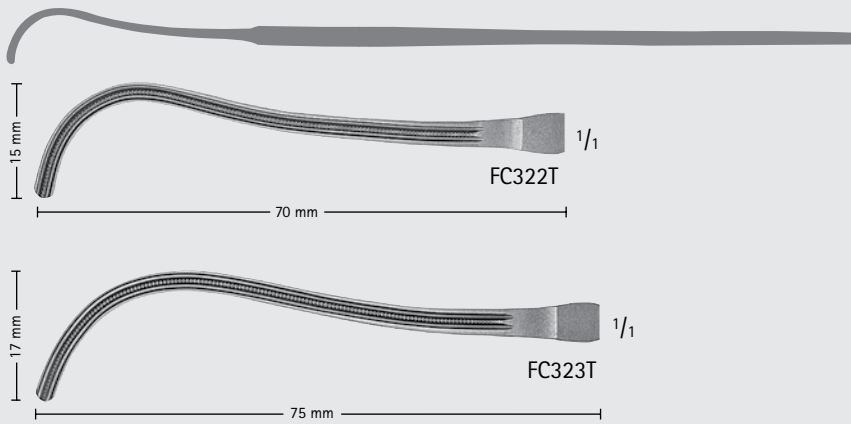

FC324T-FC325T

Titanium GLOVER Atraumatic Vascular Clamp

Catalog Number	Jaw	Jaw Length (mm)	Length (in.)
FC324T	CVD	60	8 3/4
FC325T	CVD	80	10 5/8

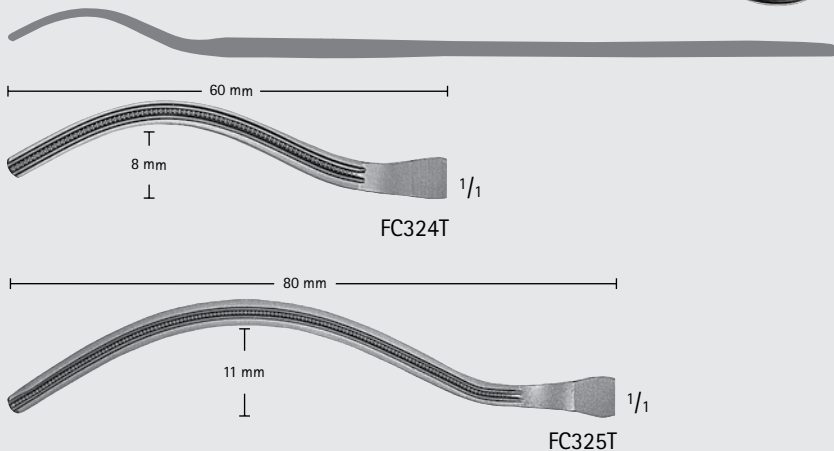

Cardiovascular Titanium Clamps

Titanium LAMBERT-KAY Atraumatic Vascular Clamp

Catalog Number	Jaw Angle	Jaw Length (mm)	Shaft	Length (in.)
FC326T	MULTI	45	ANG	7 3/4

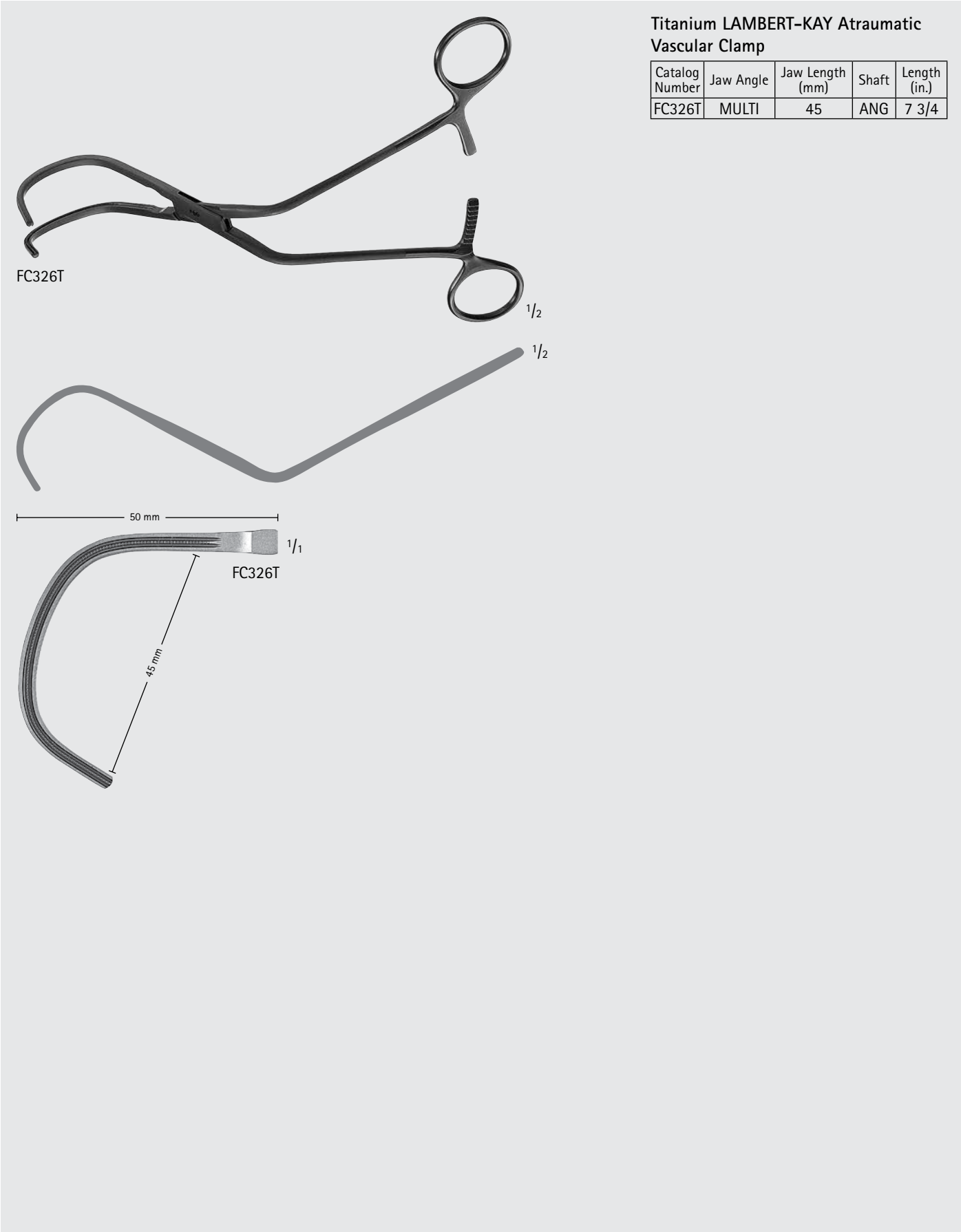

Cardiovascular

Titanium Clamps

Titanium DEBAKEY Atraumatic Vascular Clamp

Catalog Number	Jaw	Length (in.)
FC327T	SLIGHT-CVD	12 1/4
FC328T	SLIGHT-CVD	12 1/2

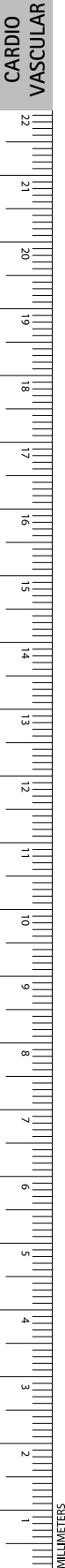
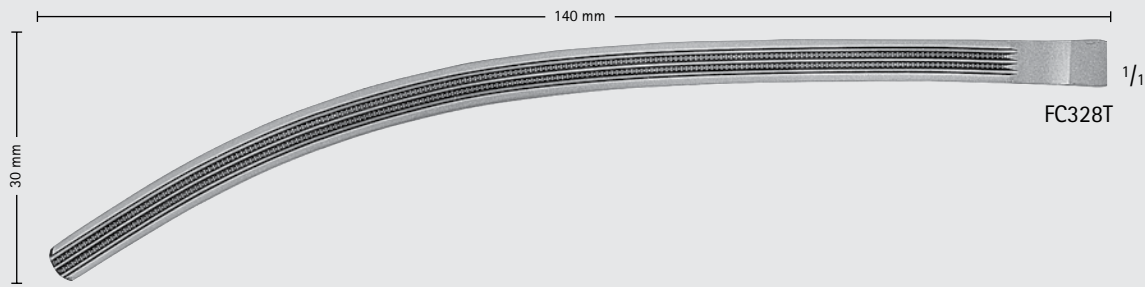
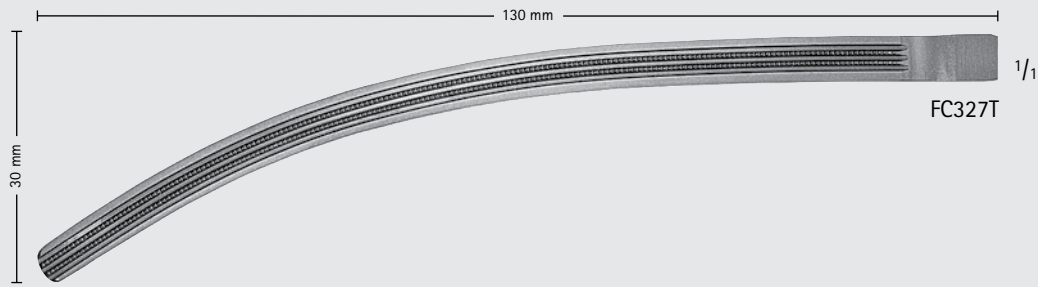
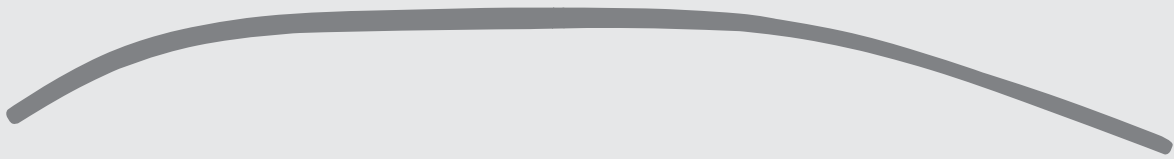
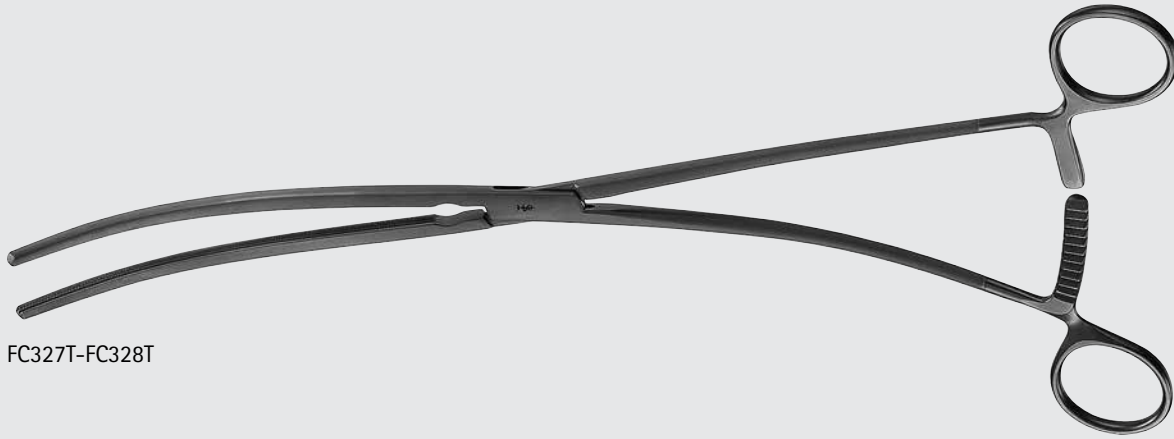

Cardiovascular Titanium Clamps

Titanium DEBAKEY Atraumatic Vascular Clamp

Catalog Number	Jaw	Shaft	Length (in.)
FC331T	CVD	ANG	7 3/4
FC330T	ANG	ANG	7



FC330T-FC331T



65 mm

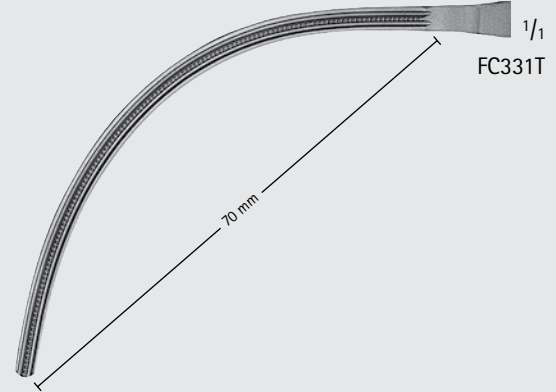

FC331T



55 mm

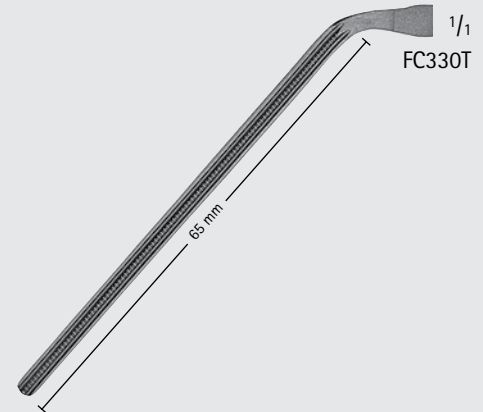

FC330T

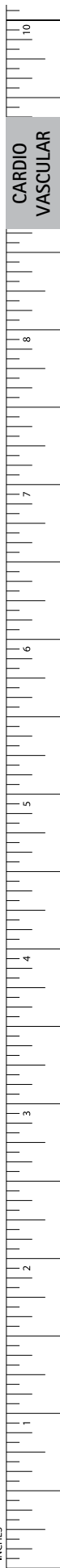

Cardiovascular

Titanium Clamps

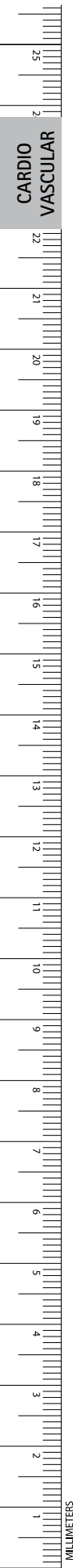

Titanium DEBAKEY Atraumatic Vascular Clamp

Catalog Number	Jaw	Length (in.)
FC329T	HEAVY-CVD	10 1/4

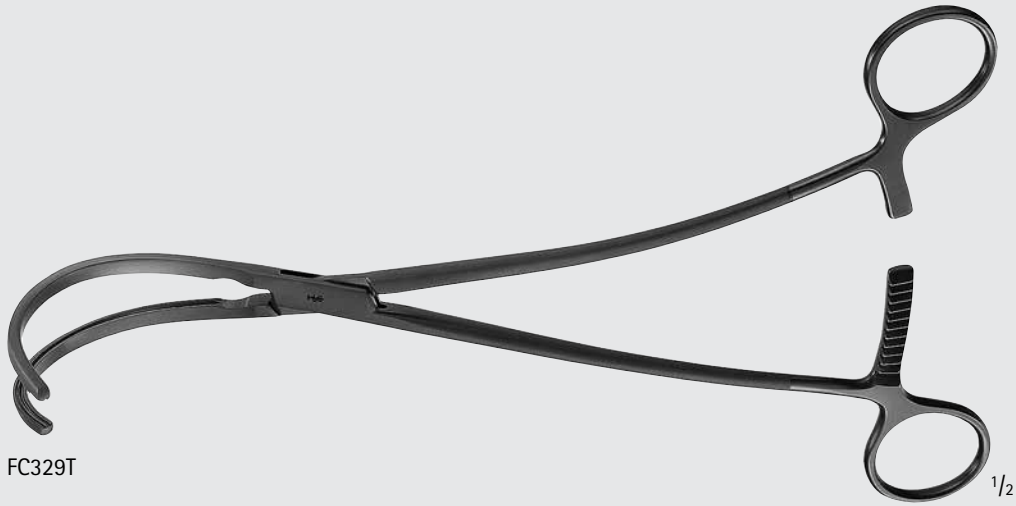

FC329T

1/2



1/2

60 mm

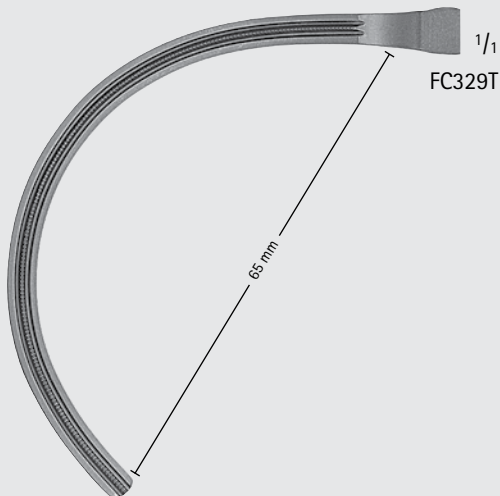

FC329T

1/1

65 mm

Cardiovascular Titanium Clamps

Titanium DEBAKEY Atraumatic Vascular Clamp

Catalog Number	Jaw	Shaft	Length (in.)
FC332T	ANG	ANG	9 1/2
FC333T	ANG	ANG	8 1/2



FC332T-FC333T

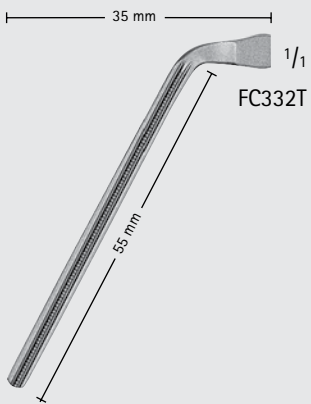

INCHES

Cardiovascular

Titanium Clamps

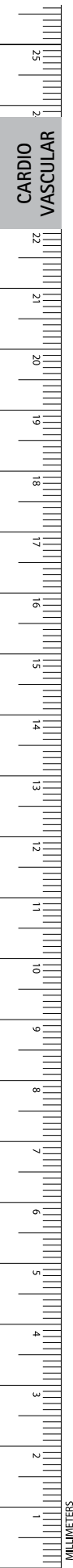

CARDIO
VASCULAR

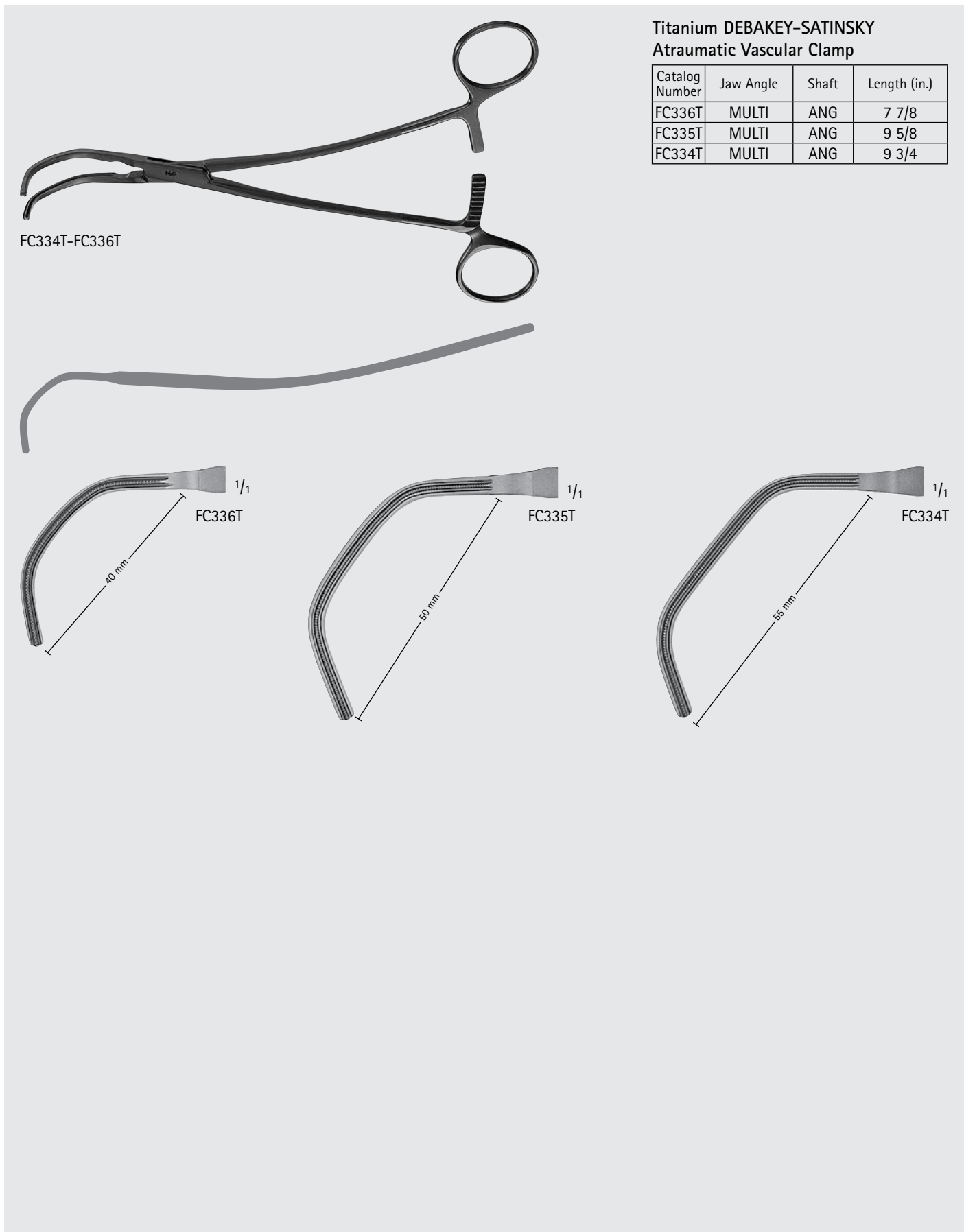

FC334T-FC336T

Titanium DEBAKEY-SATINSKY Atraumatic Vascular Clamp

Catalog Number	Jaw Angle	Shaft	Length (in.)
FC336T	MULTI	ANG	7 7/8
FC335T	MULTI	ANG	9 5/8
FC334T	MULTI	ANG	9 3/4

FC336T

40 mm

FC335T

50 mm

FC334T

55 mm

1/16

1/16

1/16

Titanium DEBAKEY Atraumatic
Pediatric Vascular Clamp

Catalog Number	Jaw Angle	Length (in.)
FC337T	STR	4 1/4
FC338T	30°	4 1/4
FC339T	45°	4 1/4
FC340T	60°	4 1/4
FC341T	MULTI	3 3/4
FC342T	MULTI	4
FC343T	MULTI	4

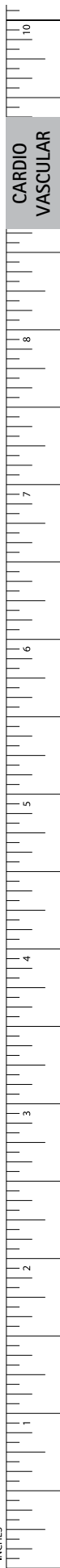
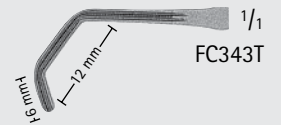
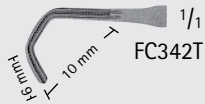
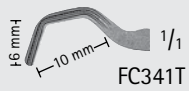
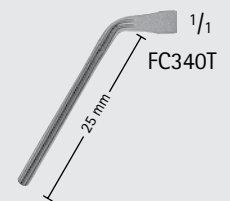
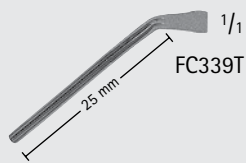
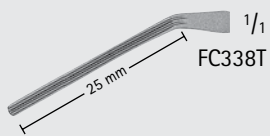
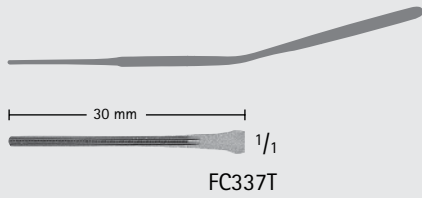
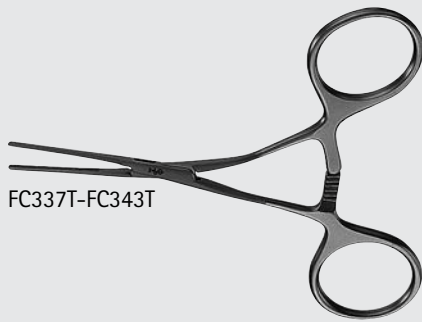

Cardiovascular

Forceps and Clamps

CARDIO
VASCULAR



Chest Tube Passer

Catalog Number	Description	Length (in.)
MG578R	W/O RATCHET	9 3/4
MG589R	W/O RATCHET	14
MG588R	W/ RATCHET	9 3/4



MG578R, MG589R



MG578R, MG589R



MG588R



MG588R

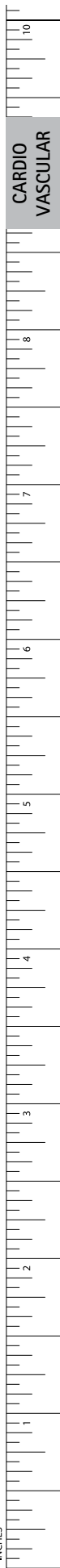

Tubing Clamp

Catalog Number	Jaw	Length (in.)
AN909R	SMOOTH	6 1/2
MD452R	SERR	6
MD453R	SERR	7
MD454R	SERR	7 7/8



AN909R

1/2



AN909R

1/1

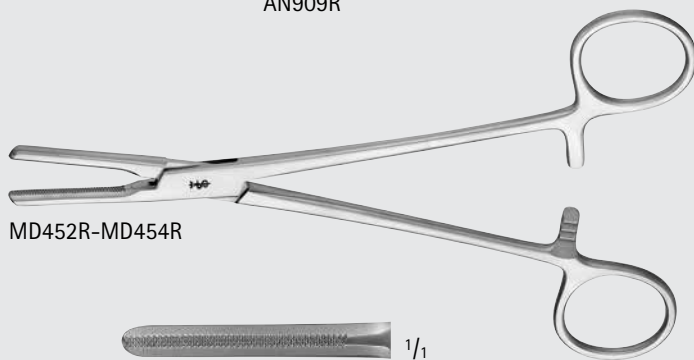

MD452R-MD454R



MD452R

1/1



MD453R

1/1



MD454R

1/1

Tubing Clamp, W/ Guard

Catalog Number	Jaw	Length (in.)
MD652	SERR	6
MD653	SERR	7
MD654	SERR	7 7/8

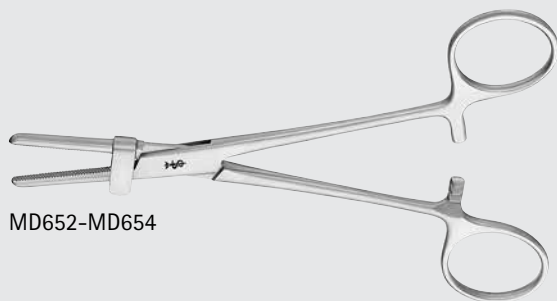

MD652-MD654



MD652

1/1



MD653

1/1



MD654

1/1

Cardiovascular

Forceps and Clamps



CARDIO
VASCULAR

SAROT Forceps, Delicate

Catalog Number	Teeth	Length (in.)
BH224R	-	9 1/2
BH234R	1 x 2	9 1/2

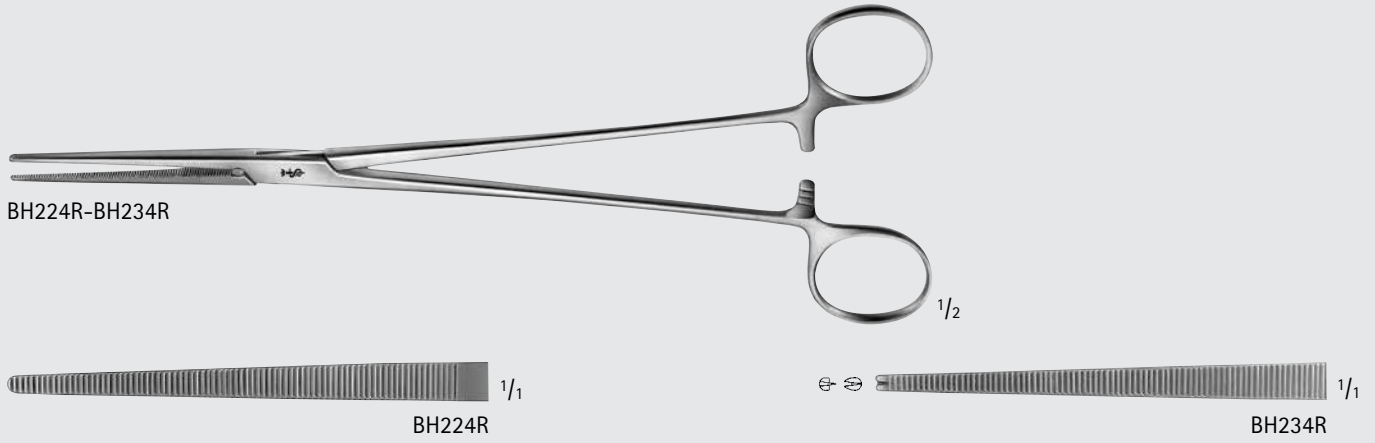

CRAFOORD Forceps, Delicate

Catalog Number	Jaw	Length (in.)
BH225R	CVD	9 5/8

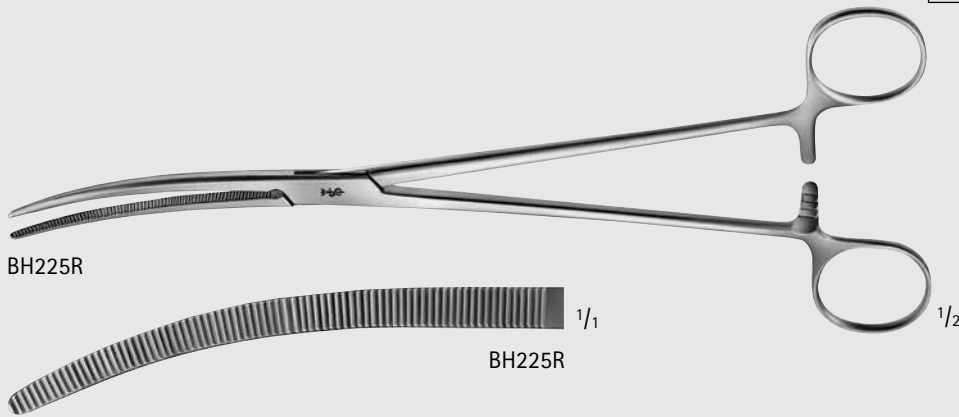

HOLLE Forceps, Delicate

Catalog Number	Jaw	Length (in.)
BJ037R	CVD	5 3/4
BJ038R	CVD	7 1/4
BJ039R	CVD	9 1/4

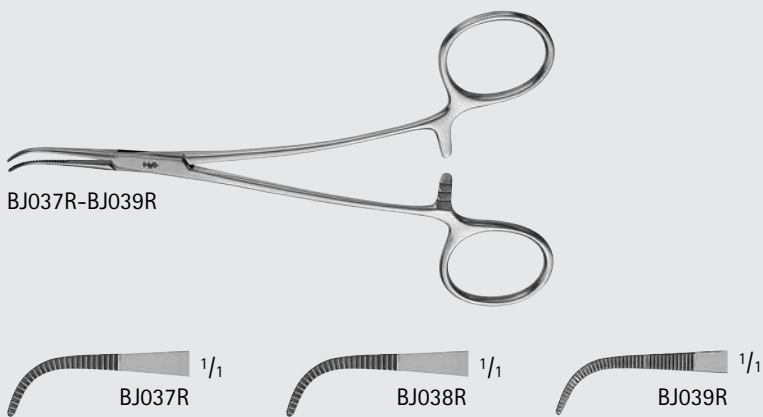

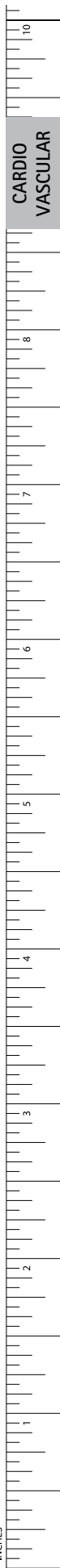

COLLER Artery Forceps

Catalog Number	Jaw Angle	Length (in.)
MG421R	90°	9 1/2

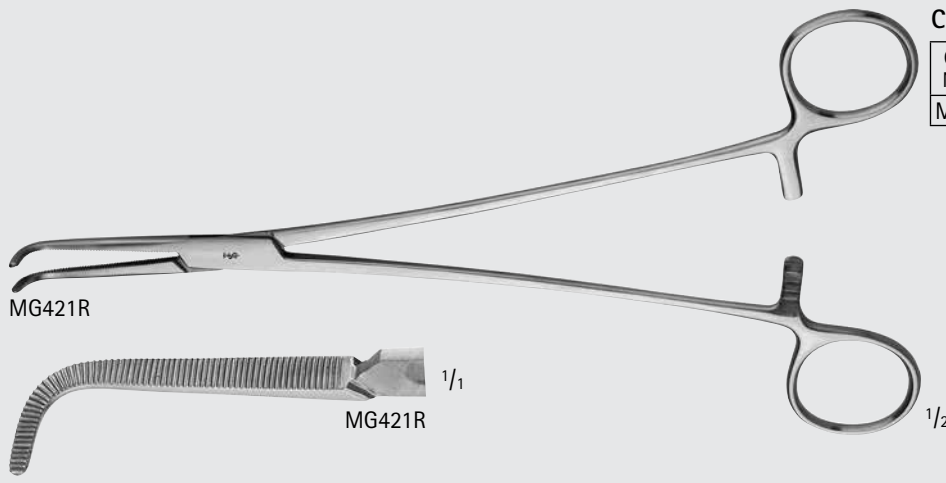

SAROT Intrathoracic Artery Forceps

Catalog Number	Jaw	Length (in.)
BH226R	SLIGHT-CVD	9 3/4

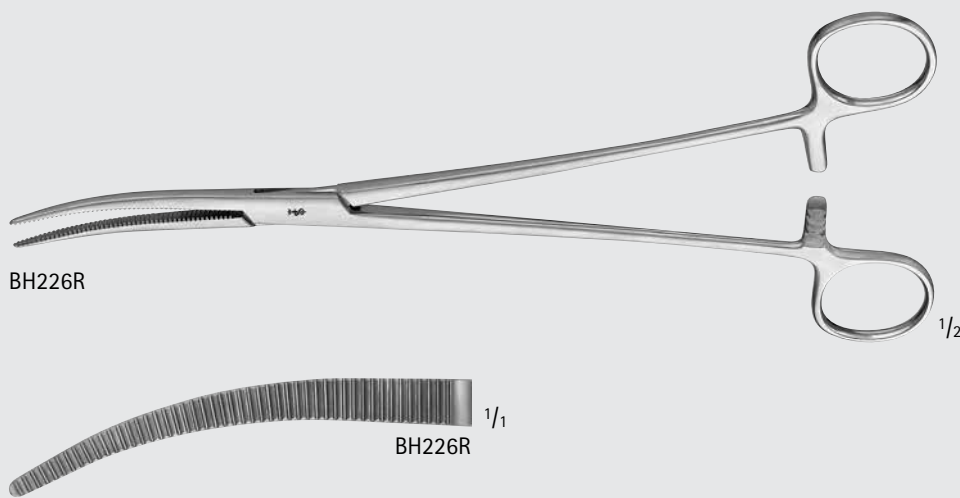

JULIAN Thoracic Artery Forceps

Catalog Number	Jaw	Length (in.)
BH233R	CVD	9 1/4

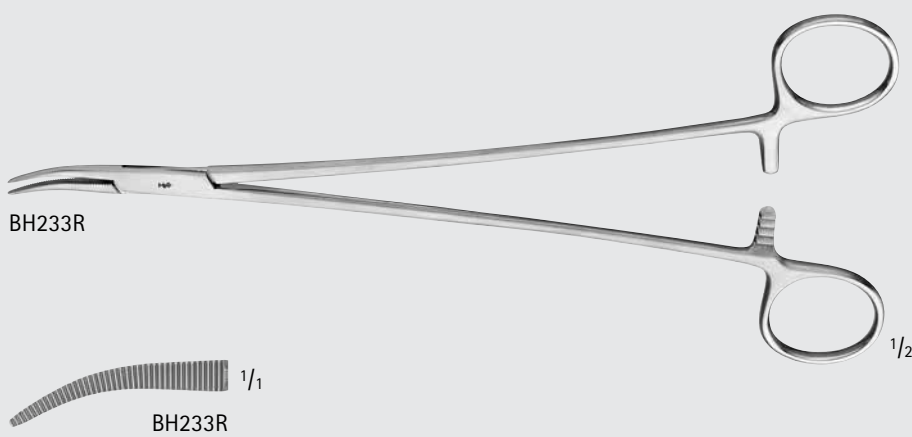

Cardiovascular

Forceps and Clamps

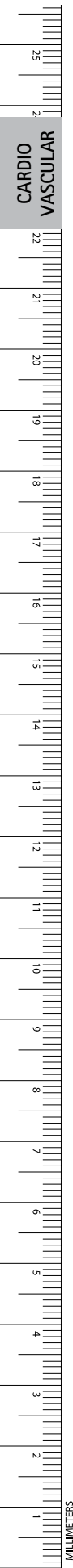

LOVELACE Lung Forceps

Catalog Number	Length (in.)
MB056R	8

MB056R

MB056R

DUVAL Lung Forceps

Catalog Number	Length (in.)
FB930R	9

FB930R

FB930R

BABCOCK Thoracic Tissue Forceps

Catalog Number	Length (in.)
MB057R	9 1/2

MB057R

MB057R

Thoracoscopy Forceps

Catalog Number	Jaw	Jaw Length (mm)	Length (in.)
MB458R	STR, LONG	158	12 1/2
MB296R	CVD, LONG	158	12 1/4

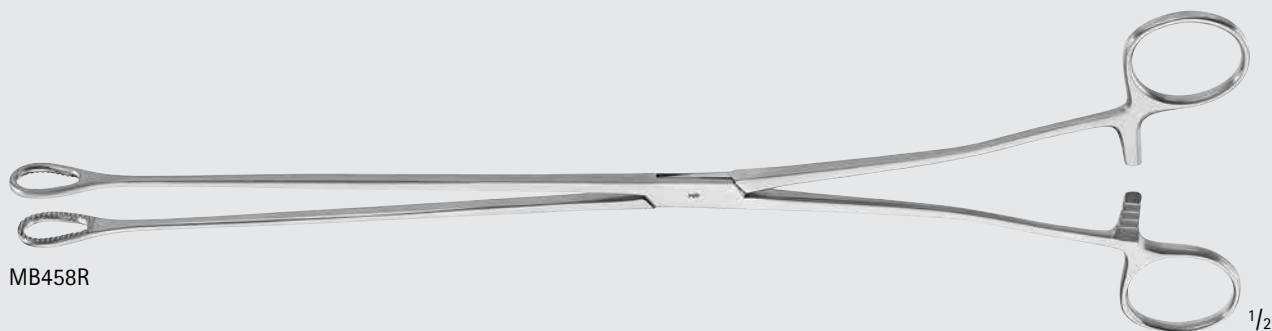

MB458R



MB458R

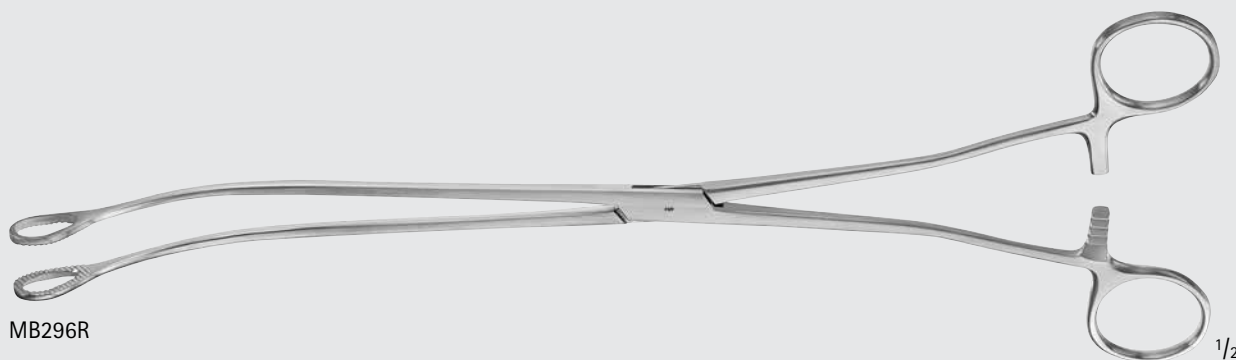

MB296R

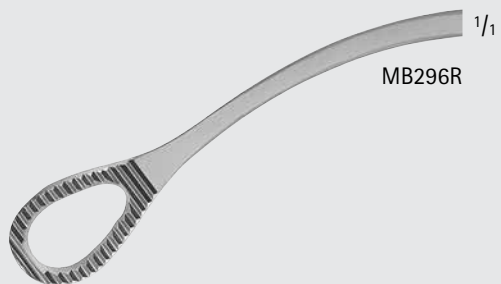

MB296R

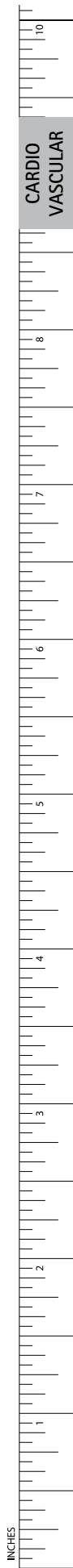

CARDIO
VASCULAR

Cardiovascular

Forceps and Clamps

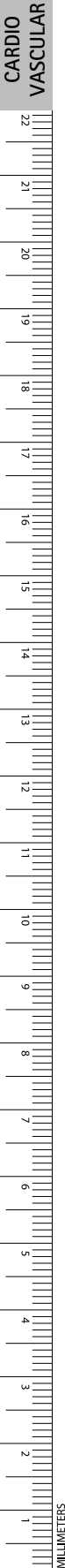

ROCHESTER-OCHSNER Artery Forceps

Catalog Number	Jaw	Teeth	Length (in.)
MB172R	STR	1 x 2	14

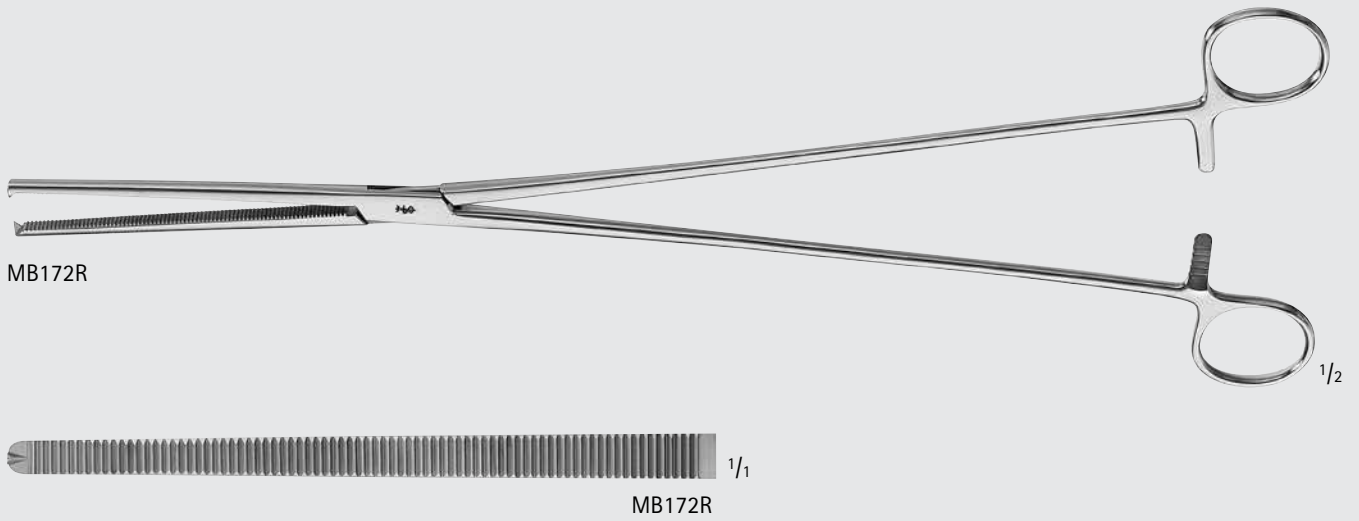

CARMALT Artery Forceps, Longitudinal Serrations

Catalog Number	Jaw	Length (in.)
MB182R	SLIGHT-CVD	12

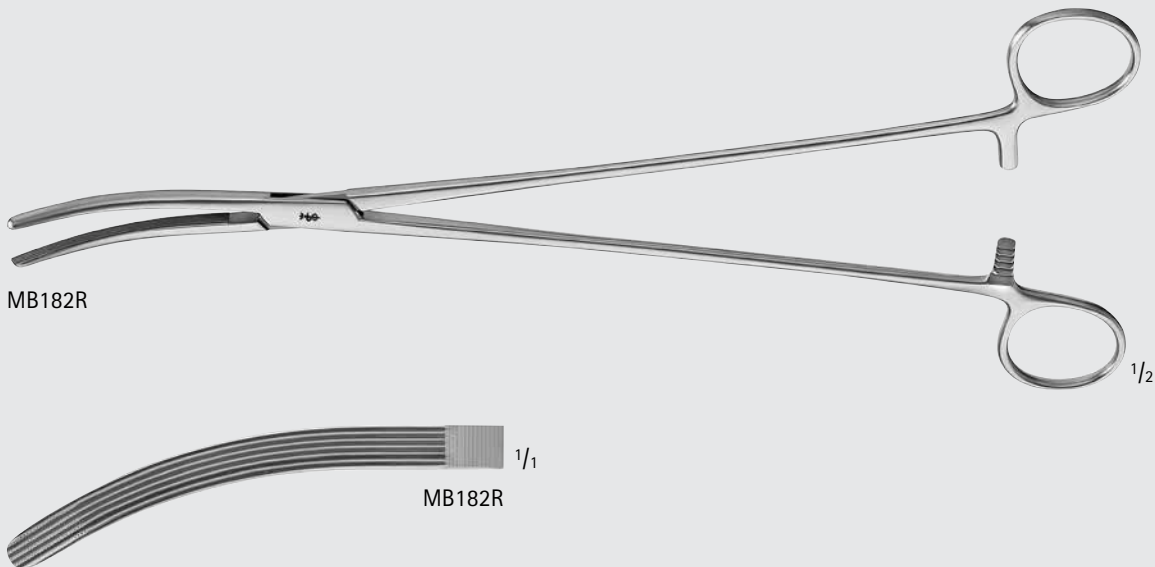

COOLEY Bronchus Clamp

Catalog Number	Jaw	Length (in.)
MG449R	ANG	8 1/4

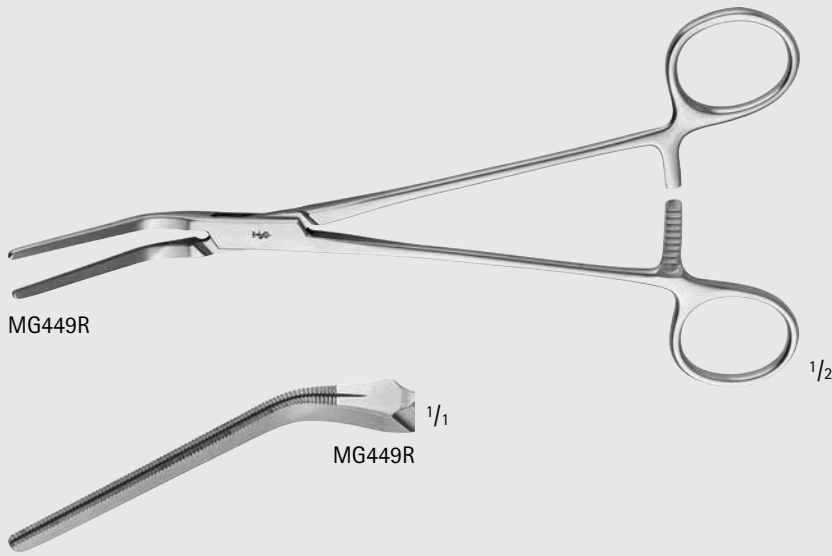

Bronchus Clamp, Longitudinal Serrations

Catalog Number	Jaw Angle	Jaw Length (mm)	Length (in.)
FB954R	90°	60	9
FB955R	90°	80	9

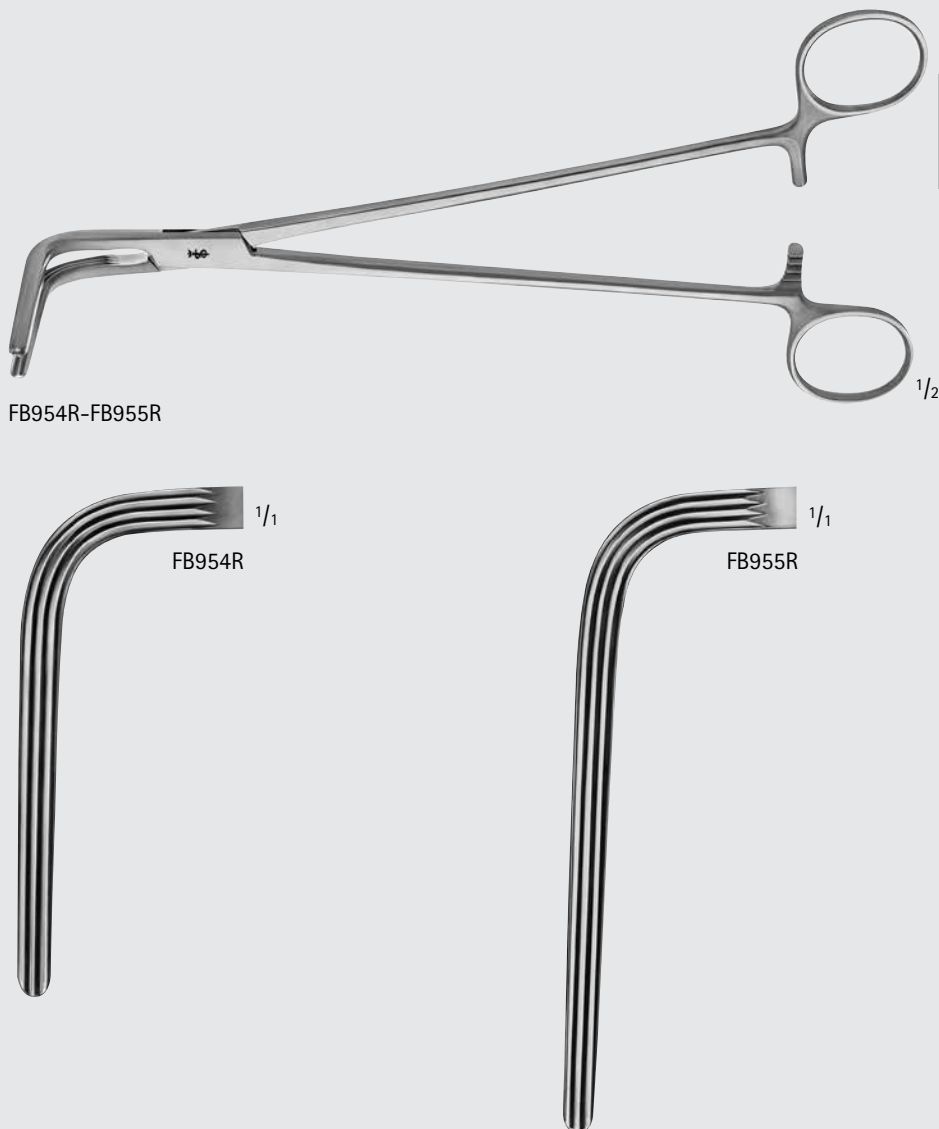

Cardiovascular

Forceps and Clamps

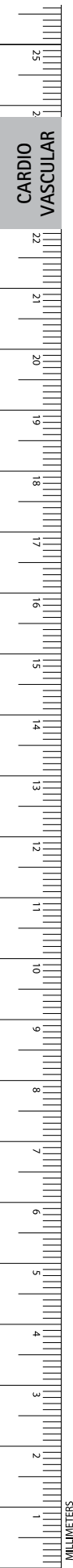

CARDIO
VASCULAR

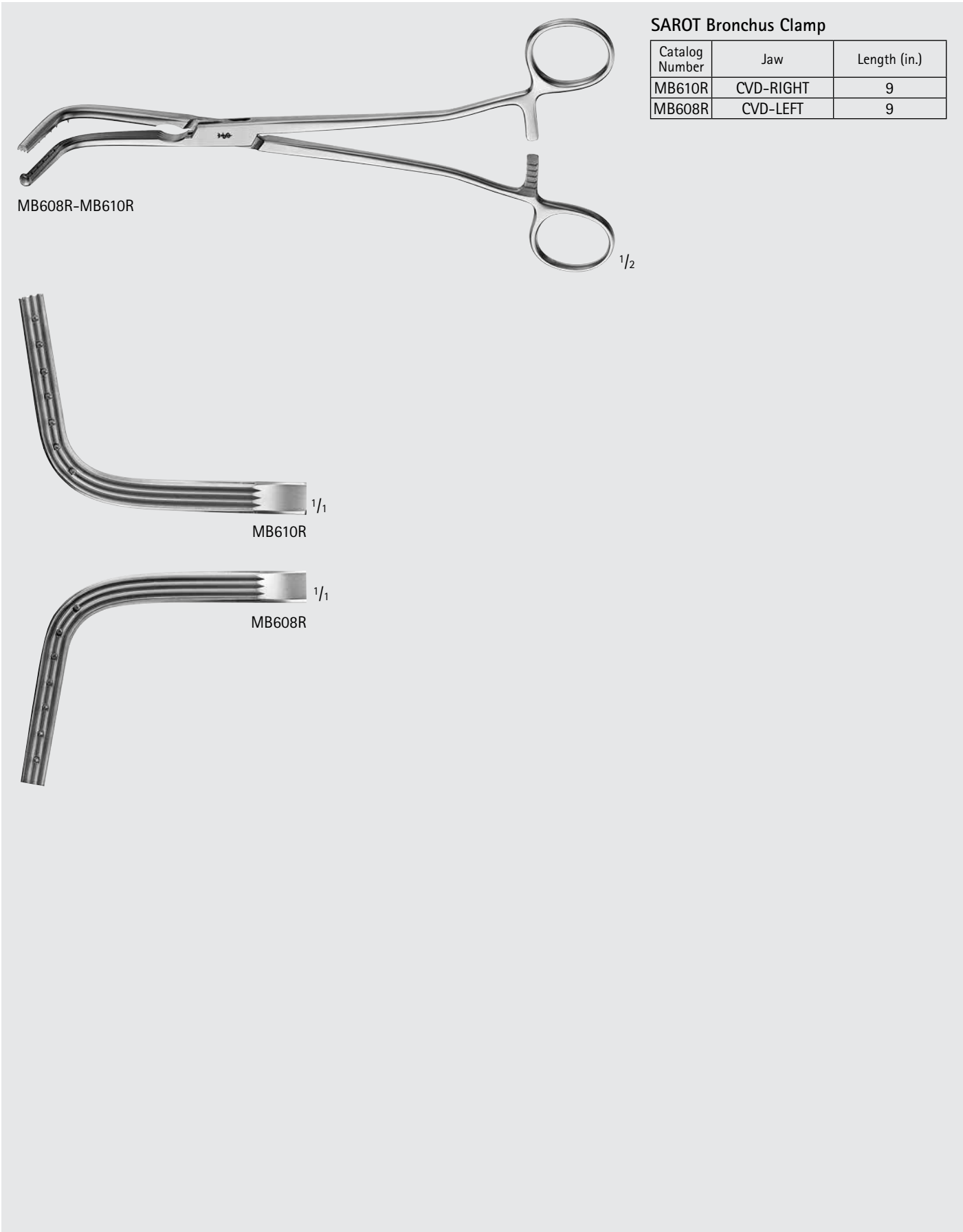

SAROT Bronchus Clamp

Catalog Number	Jaw	Length (in.)
MB610R	CVD-RIGHT	9
MB608R	CVD-LEFT	9

MB608R-MB610R

1/2

MB610R

1/1

MB608R

1/1



FOGARTY-Type Clamp

Catalog Number	Jaw	Jaw Length (mm)	Length (in.)
MB091R	STR	33	6 1/2
MB070R	STR	61	11 5/8
MB096R	STR	86	12 1/4
MB092R	ANG	33	4 5/8
MB094R	ANG	61	8 1/2
MB093R	ANG	61	8 3/4
MB095R	ANG	86	9 1/4

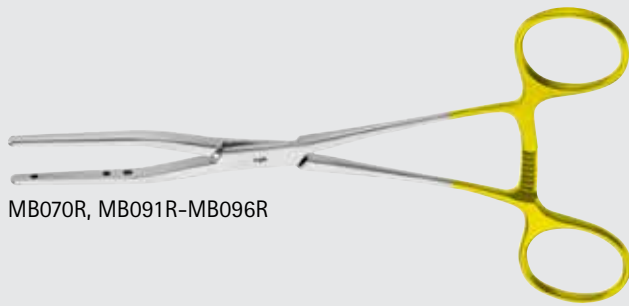

MB070R, MB091R-MB096R



MB092R



MB093R



MB094R

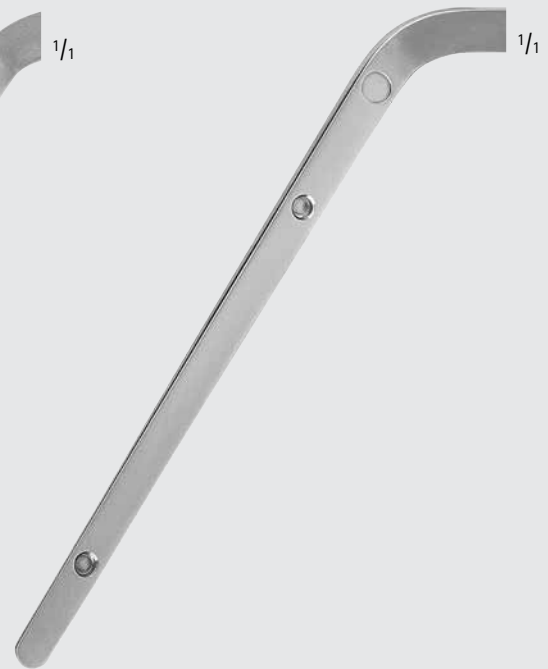

MB095R



MB091R



MB070R

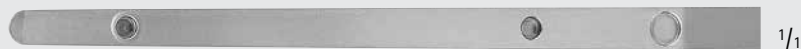

MB096R

FOGARTY-Type Spring Clip Applicator

Catalog Number	Teeth	Length (in.)
MB097R	1 x 2	7 1/4



MB097R



MB097R

Cardiovascular

Vascular Clamps

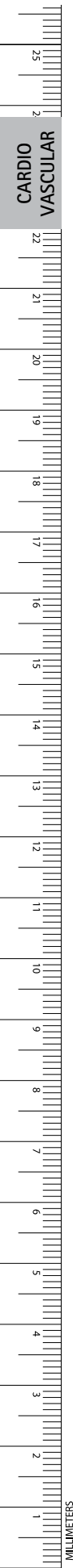

CARDIO
VASCULAR

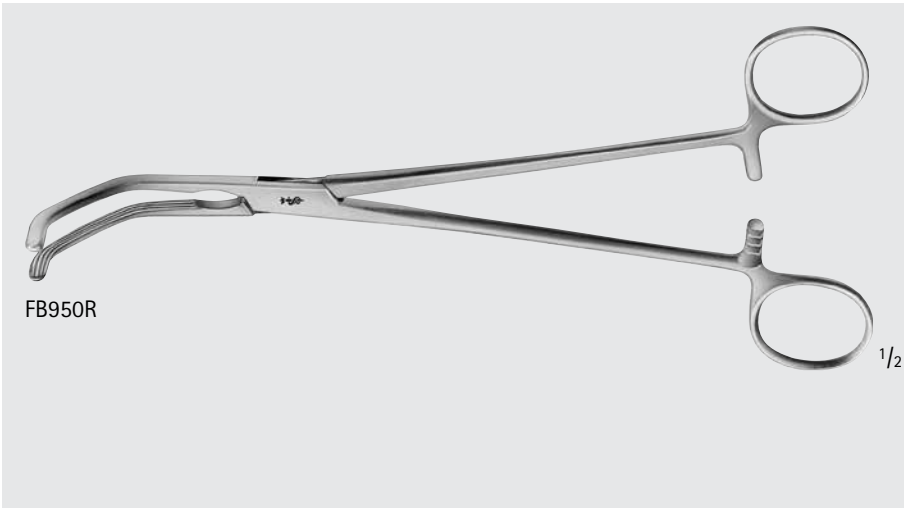

PRICE-THOMAS Bronchus Forceps

Catalog Number	Length (in.)
FB950R	8 7/8

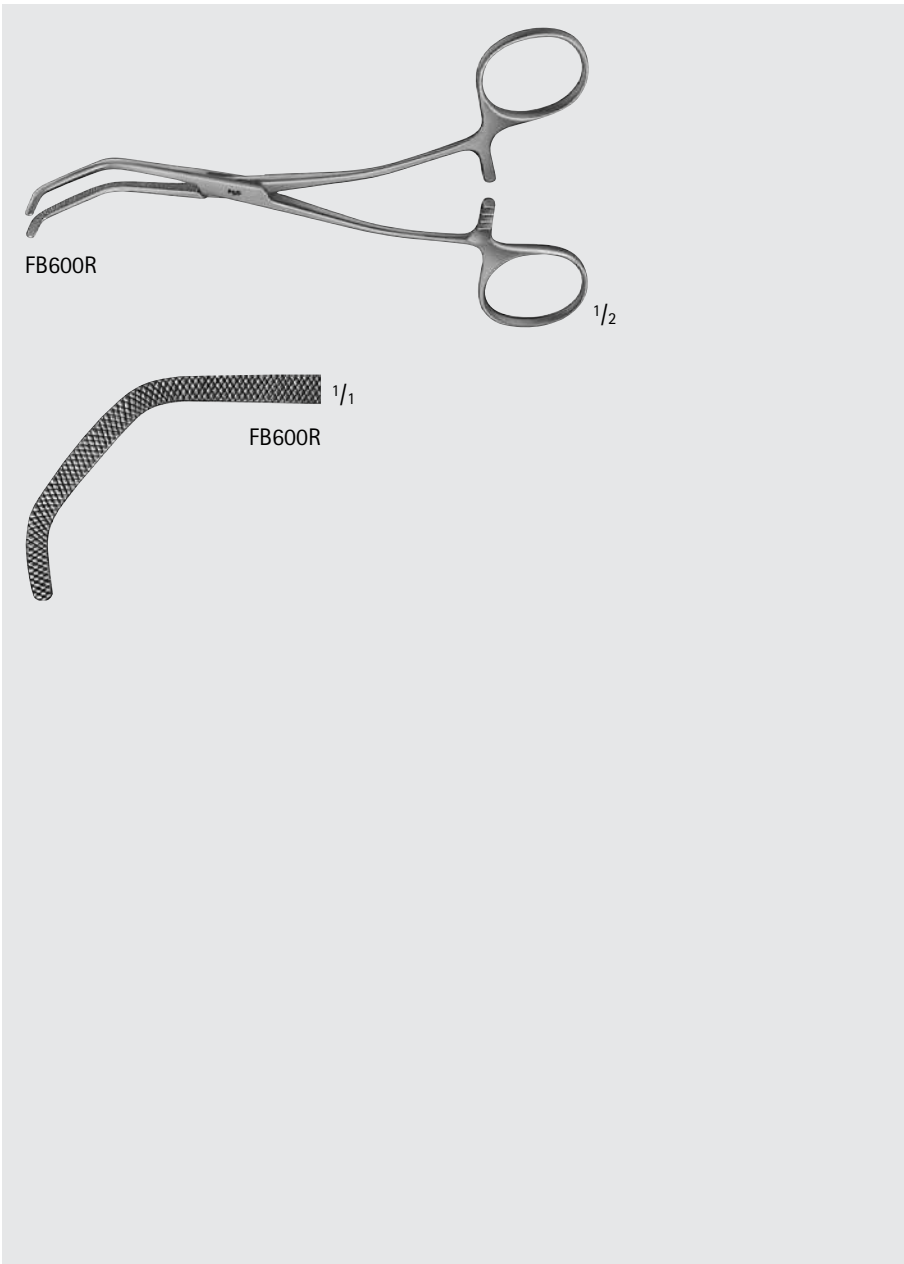
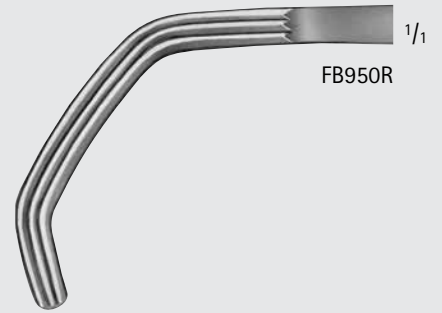

Baby SATINSKY Vena Cava Clamp

Catalog Number	Jaw	Length (in.)
FB600R	X-SERR	6

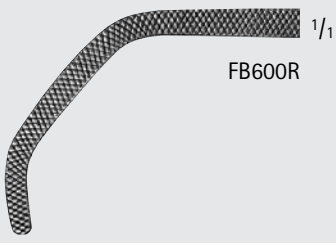

Cardiovascular

Vascular Clamps

SATINSKY Vena Cava Clamp

Catalog Number	Jaw	Jaw Size	Shaft	Length (in.)
FB602R	ANG, X-SERR	LARGE	STR	10 1/2
FB604R	ANG, X-SERR	SMALL	LIGHT-CVD	10 1/2
FB605R	ANG, X-SERR	LARGE	LIGHT-CVD	10 1/2

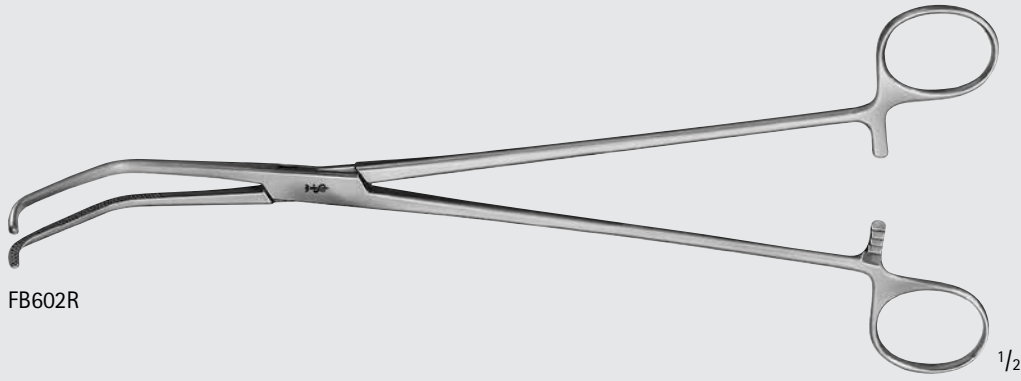

FB602R

1/2

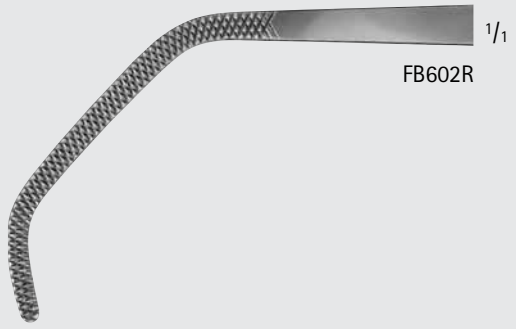

FB602R

1/1



FB604R-FB605R

1/2

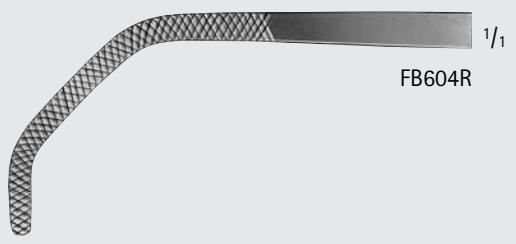

FB604R

1/1

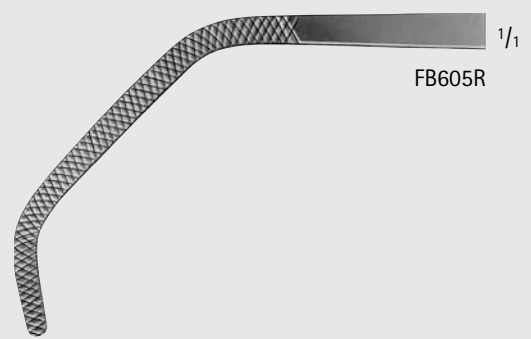

FB605R

1/1



Cardiovascular

Vascular Clamps

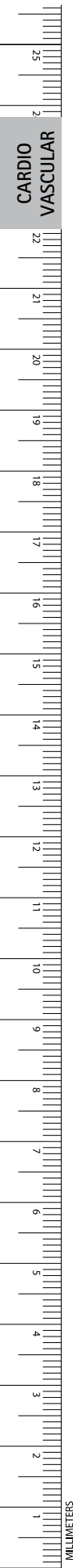

CARDIO
VASCULAR

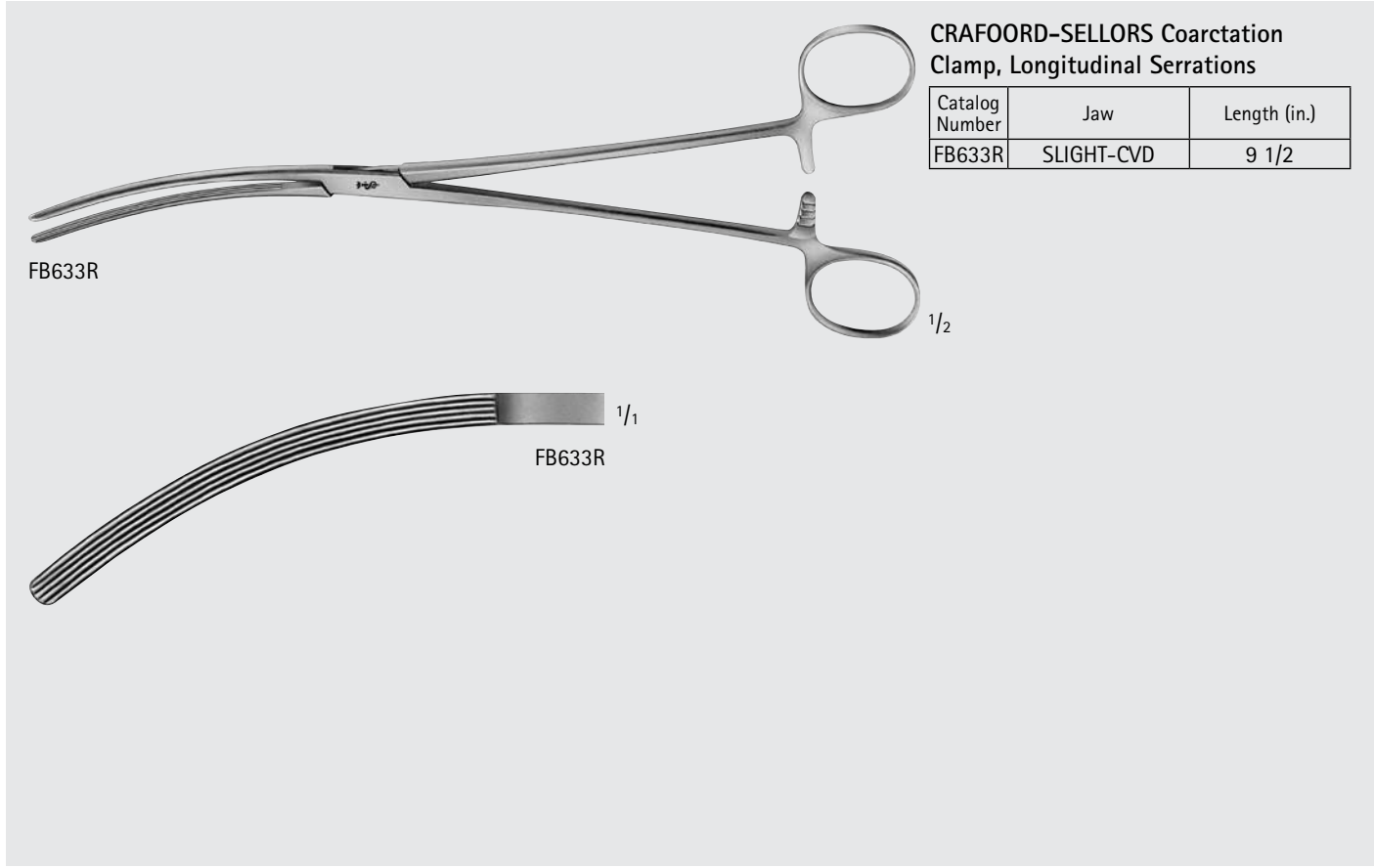

CRAFOORD-SELLORS Coarctation Clamp, Longitudinal Serrations

Catalog Number	Jaw	Length (in.)
FB633R	SLIGHT-CVD	9 1/2

FB633R

FB633R

1/1

1/2

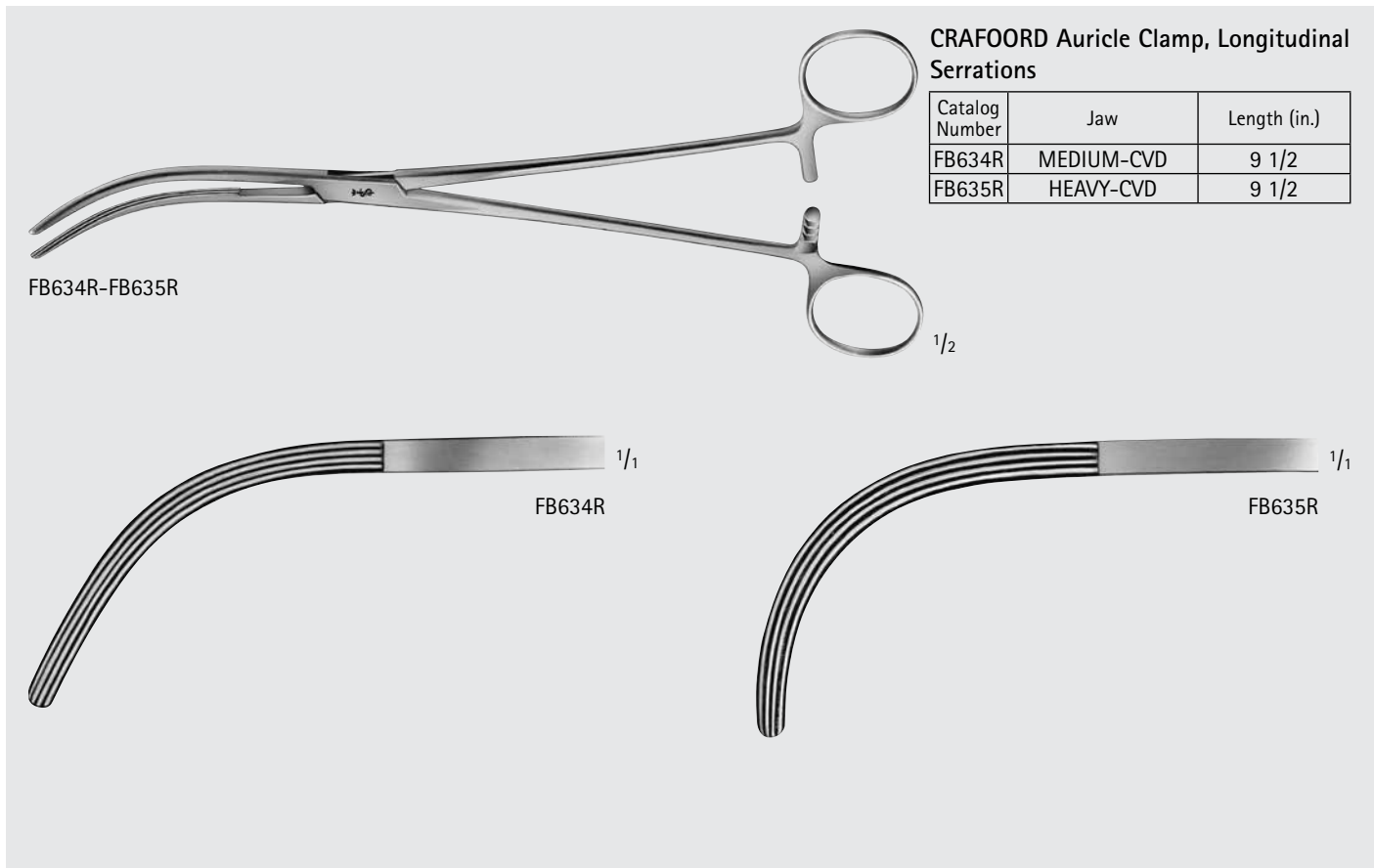

CRAFOORD Auricle Clamp, Longitudinal Serrations

Catalog Number	Jaw	Length (in.)
FB634R	MEDIUM-CVD	9 1/2
FB635R	HEAVY-CVD	9 1/2

FB634R-FB635R

FB634R

1/1

FB635R

1/1

1/2

Cardiovascular
Vascular Clamps

SEMB Suture Forceps

Catalog Number	Jaw	Length (in.)
FB961R	HEAVY-CVD	9 1/2

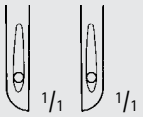
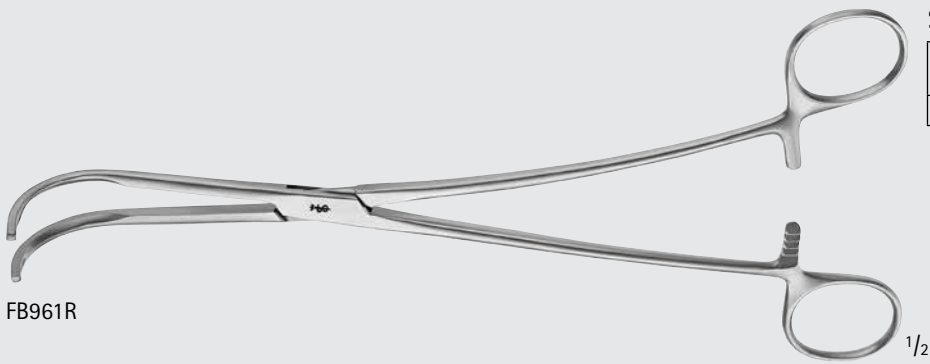

HALLMAN Tunnelling Forceps

Catalog Number	Jaw	Length (in.)
MG075R	SERR RING	13 1/2

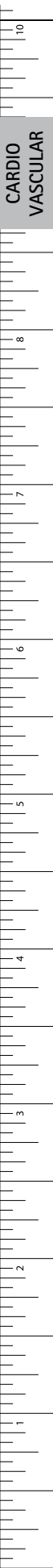
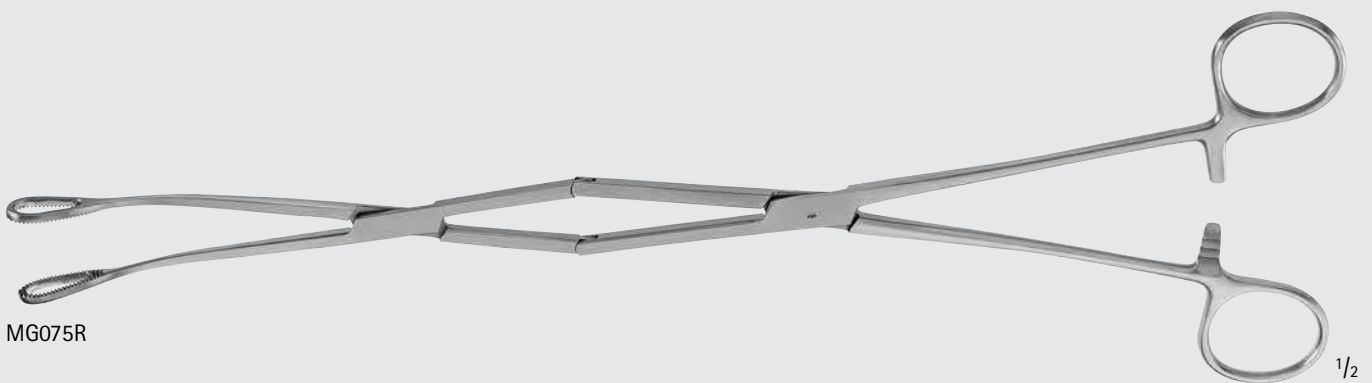

Cardiovascular

Vascular Clamps

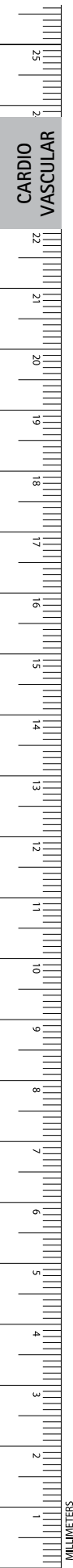

CARDIO
VASCULAR

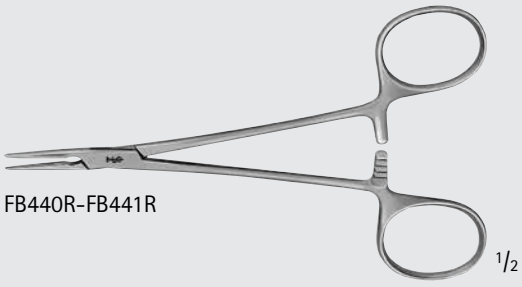

FB440R-FB441R



FB440R



FB441R

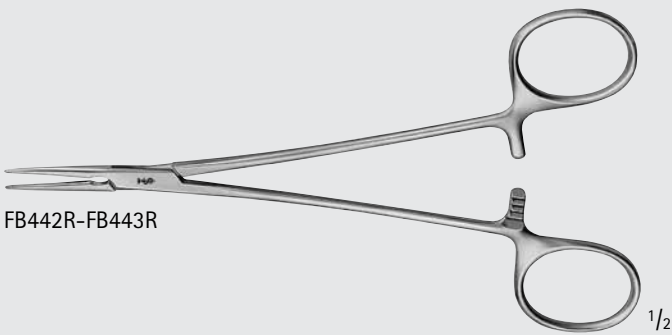

FB442R-FB443R



FB442R



FB443R

DEBAKEY Mosquito Atraumatic Forceps

Catalog Number	Jaw	Jaw Length (mm)	Length (in.)
FB440R	STR	20	5
FB442R	STR	27	6 1/2
FB441R	CVD	20	5
FB443R	CVD	27	6 1/2

Cardiovascular

Vascular Clamps

CARDIO
VASCULAR

DEBAKEY-BAINBRIDGE Atraumatic Forceps

Catalog Number	Jaw	Jaw Length (mm)	Length (in.)
FB446R	STR	40	6 1/8
FB448R	STR	65	7
FB447R	CVD	40	6 1/8
FB449R	CVD	65	7

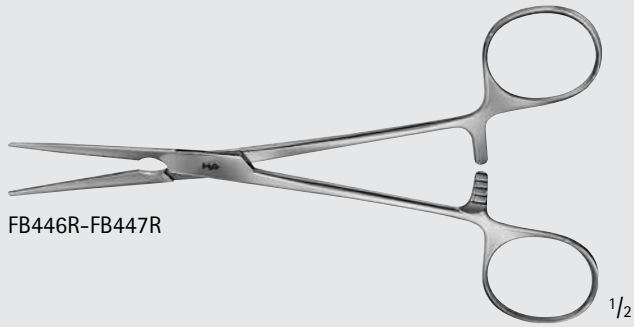

FB446R-FB447R

1/2



FB446R



FB447R

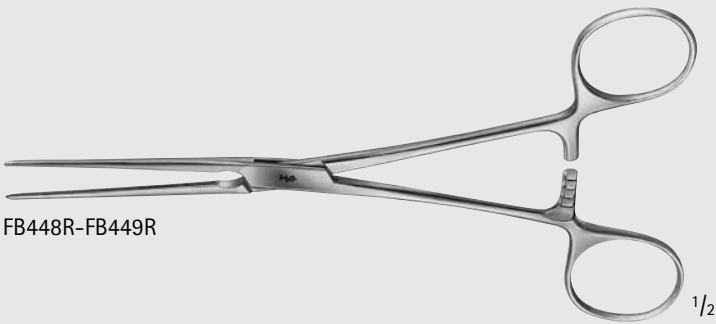

FB448R-FB449R

1/2



FB448R



FB449R

INCHES

Cardiovascular

Vascular Clamps

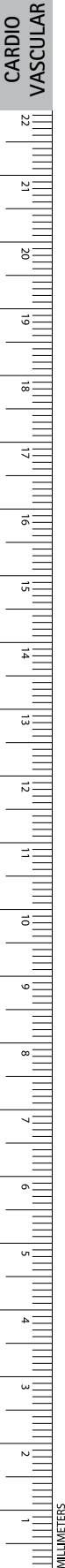

DEBAKEY-HARKEN Atraumatic Vascular Clamps

Catalog Number	Tip Size (#)	Jaw	Jaw Length (mm)	Length (in.)
FB521R	1	CVD	86	10
FB522R	2	CVD	86	9 5/8
FB523R	3	CVD	86	9 5/8
FB524R	4	CVD	86	9 3/4

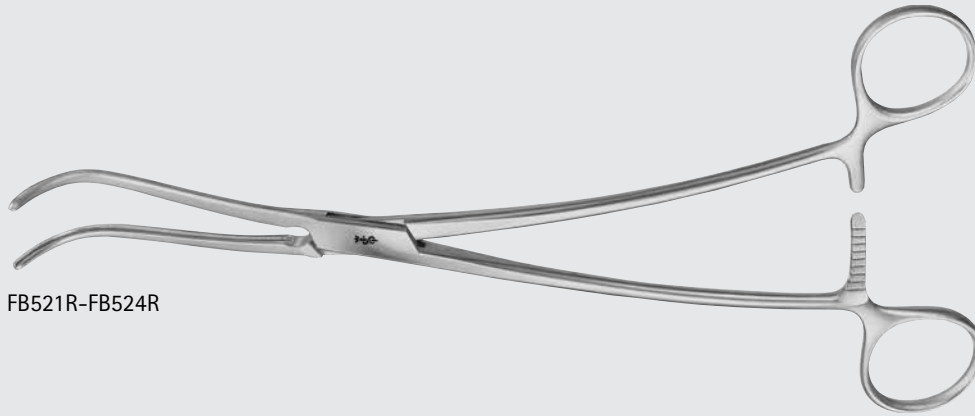

FB521R-FB524R

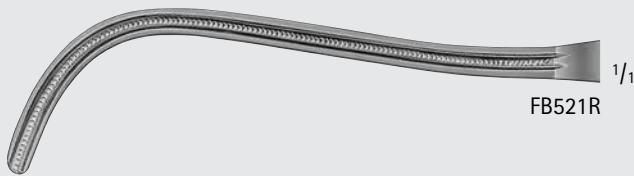

FB521R

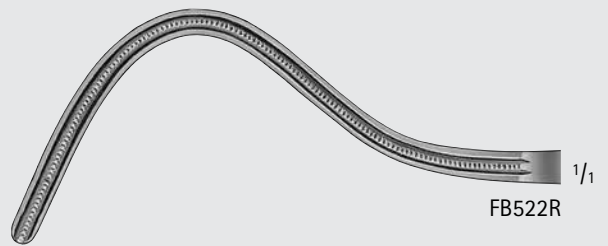

FB522R

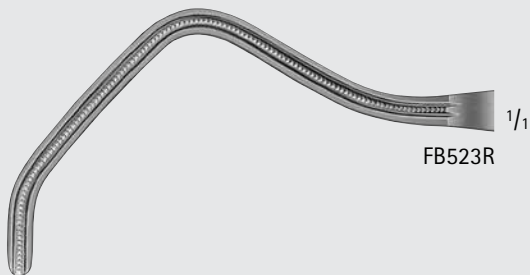

FB523R

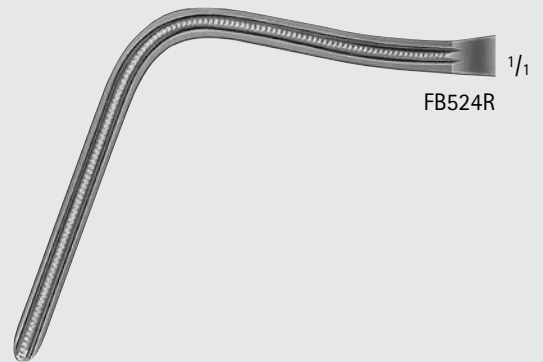

FB524R

DEBAKEY-PEAN Atraumatic Forceps

Catalog Number	Jaw	Jaw Length (mm)	Length (in.)
FB526R	STR	60	7 7/8
FB532R	STR	89	10 1/2
FB534R	STR	99	11
FB527R	CVD	60	7 7/8
FB533R	CVD	89	10 1/4
FB535R	CVD	99	10 3/4



FB526R-FB535R



FB526R



FB532R



FB534R



FB527R

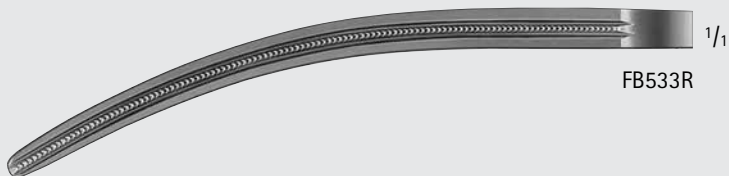

FB533R

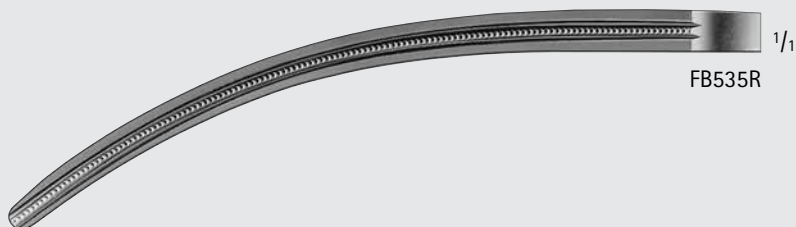

FB535R



Cardiovascular

Vascular Clamps

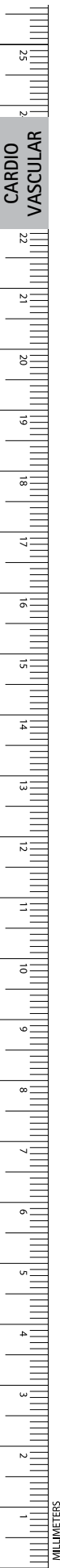

CARDIO
VASCULAR

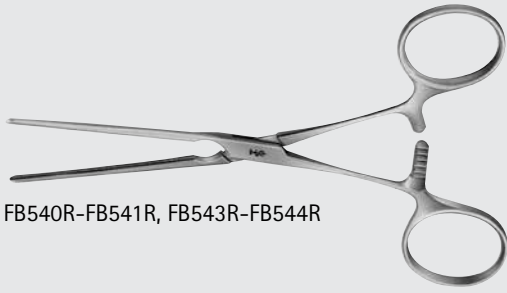

FB540R-FB541R, FB543R-FB544R

DEBAKEY Atraumatic Ring Handle Bulldog Clamp

Catalog Number	Jaw Angle	Jaw Length (mm)	Length (in.)
FB540R	STR	53	5 1/8
FB541R	CVD	53	5
FB542R	CVD*	53	5
FB543R	45°	53	5
FB544R	90°	53	4 1/8

*Instrument is S-Shaped

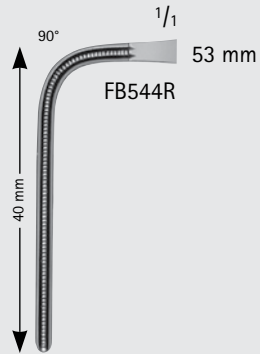
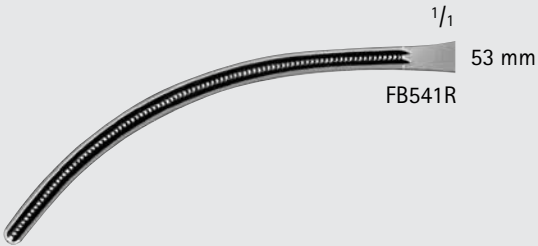
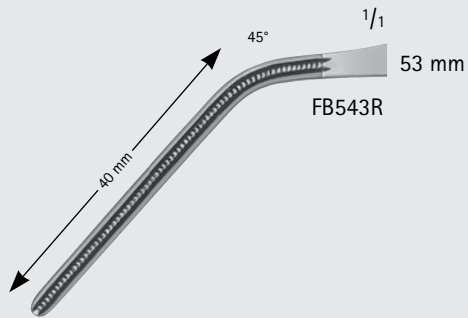

FB542R

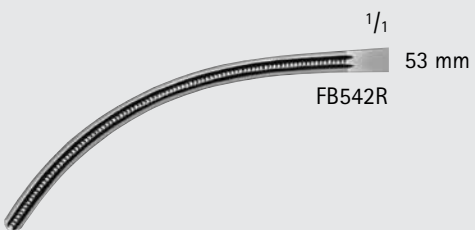

Cardiovascular

Vascular Clamps



DEBAKEY Atraumatic Multi-Purpose Clamp, Curved

Catalog Number	Jaw Length (mm)	Length (in.)
FB557R	31	6 1/2
FB558R	40	6 3/4

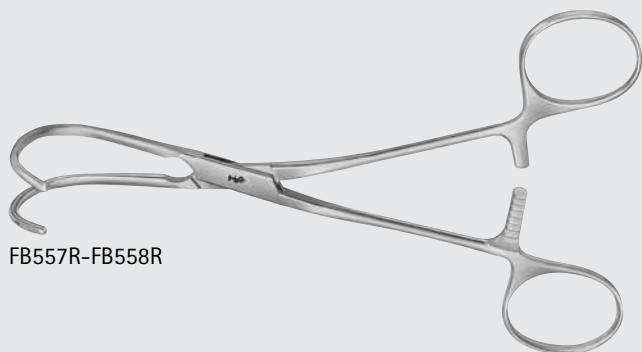

FB557R-FB558R

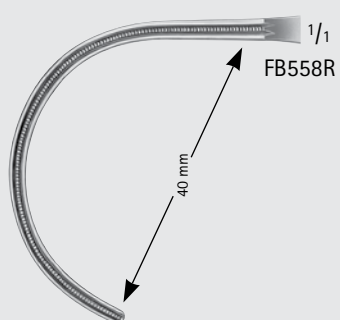
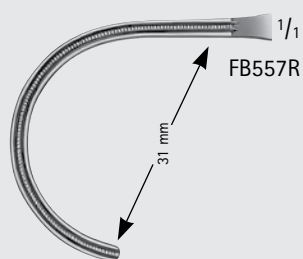

COOLEY Atraumatic Pediatric Vascular Clamp

Catalog Number	Jaw Angle	Jaw Length (mm)	Length (in.)
FB563R	MULTI	24	6 1/4

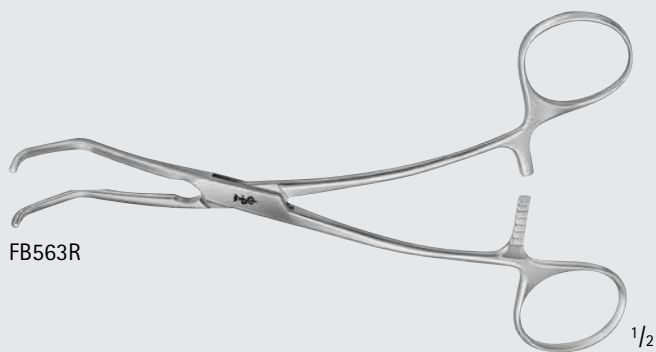

FB563R

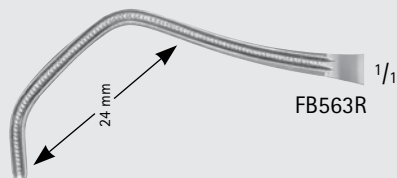

Cardiovascular

Vascular Clamps

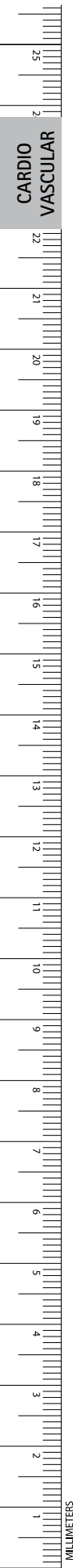

CARDIO
VASCULAR

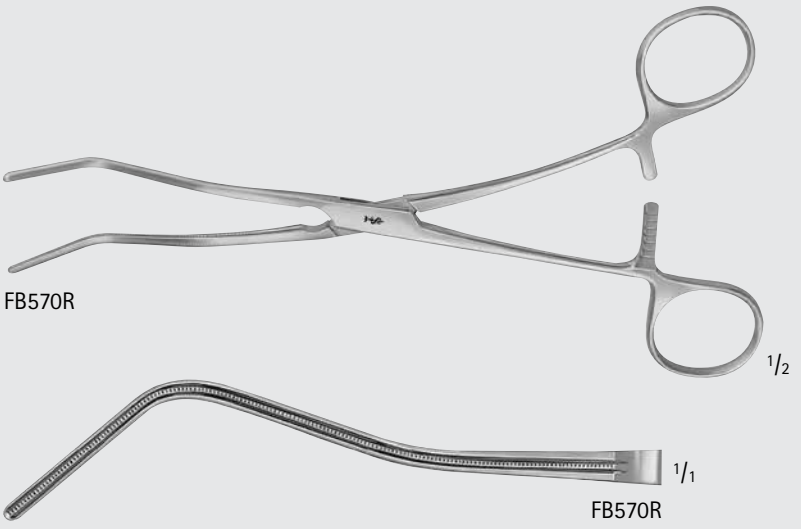
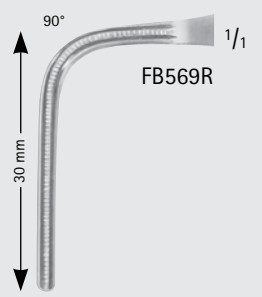
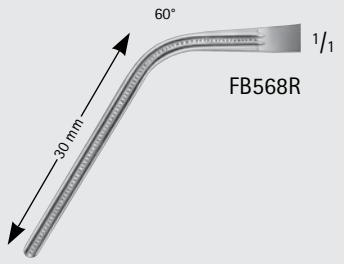
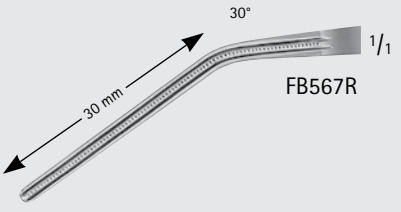
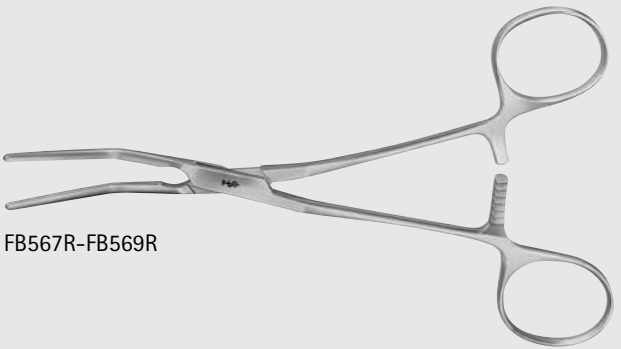
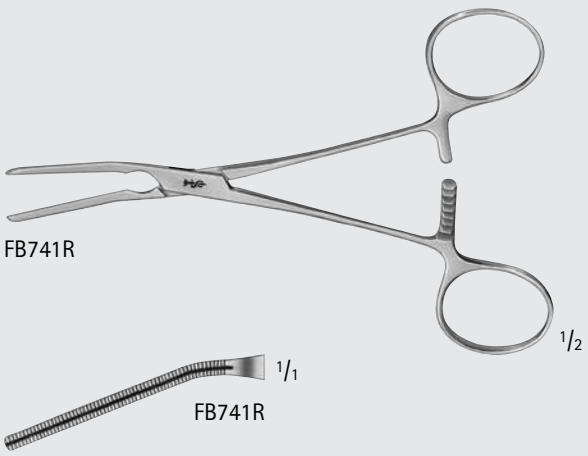

COOLEY Atraumatic Pediatric Vascular Clamp (continued)

Catalog Number	Jaw Angle	Jaw Length (mm)	Length (in.)
FB741R	25°	38	5 3/4
FB567R	30°	30	6 1/2
FB568R	60°	30	6 1/4
FB569R	90°	30	6
FB570R	MULTI	90	7 7/8

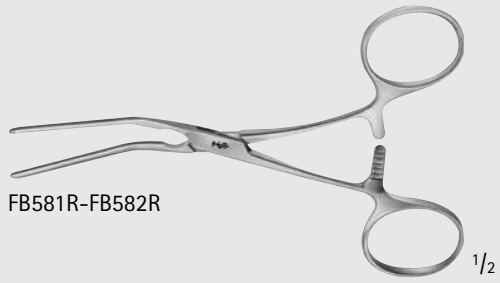

FB581R-FB582R

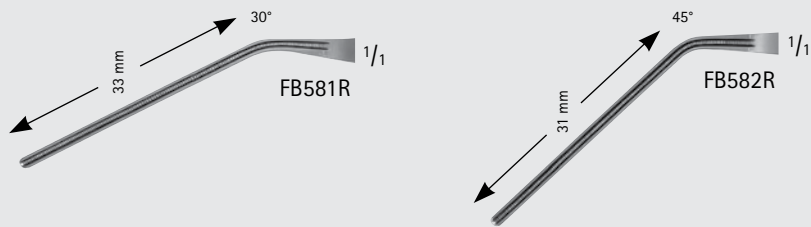

**CASTANEDA Atraumatic Neonatal
Clamp, Angled**

Catalog Number	Jaw Angle	Jaw Length (mm)	Length (in.)
FB581R	30°	33	4 3/4
FB582R	45°	31	4 3/4

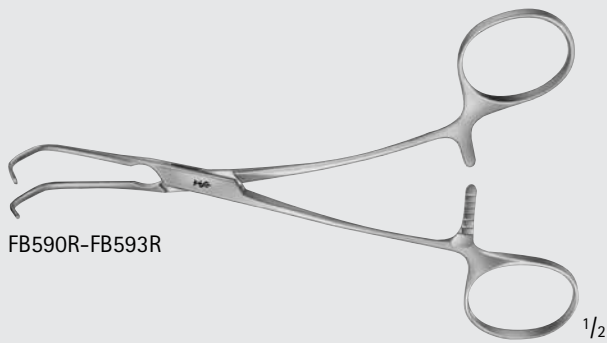

FB590R-FB593R

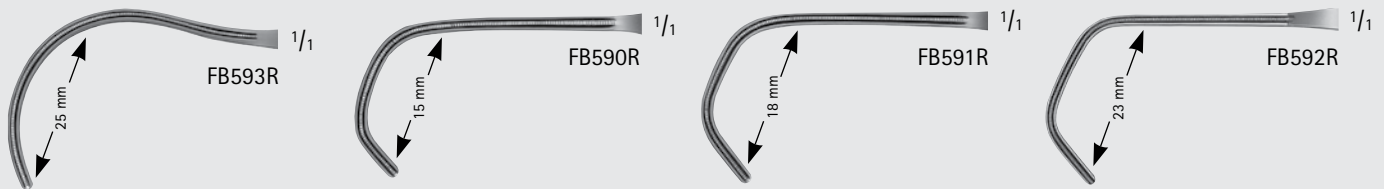

**CASTANEDA Atraumatic Neonatal
Clamp**

Catalog Number	Jaw Angle	Jaw Length (mm)	Length (in.)
FB593R	CVD	15	6 1/8
FB590R	MULTI	18	6 1/8
FB591R	MULTI	23	6 1/8
FB592R	MULTI	25	6 1/8

Cardiovascular

Vascular Clamps

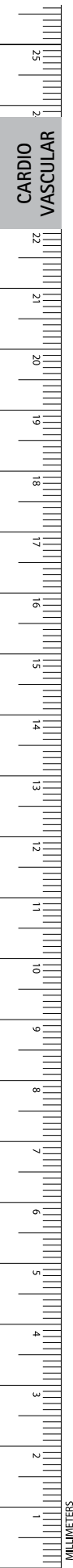

CARDIO
VASCULAR

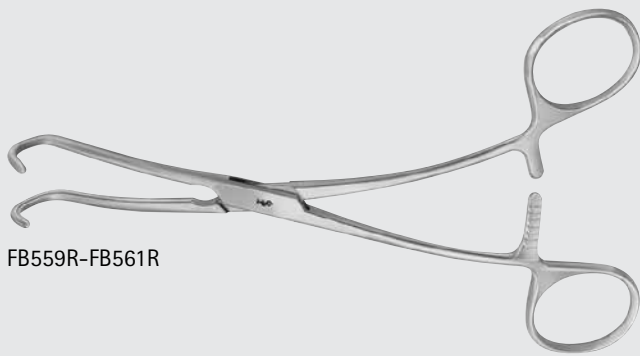

FB559R-FB561R

DERRA Atraumatic Pediatric Forceps

Catalog Number	Jaw Angle	Jaw Length (mm)	Length (in.)
FB559R	MULTI	16	6 3/4
FB560R	MULTI	20	6 3/4
FB561R	MULTI	26	6 7/8



FB559R



FB560R

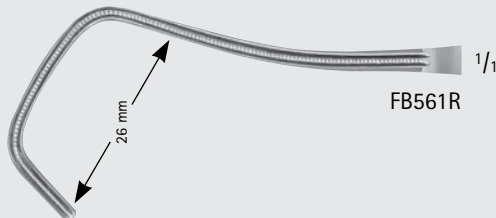

FB561R

Cardiovascular

Vascular Clamps

LELAND-JONES Atraumatic Peripheral Clamp

Catalog Number	Jaw Angle	Jaw Length (mm)	Length (in.)
FB469R	STR	77	7 3/4
FB468R	15°	65	7 1/2
FB467R	30°	65	7 1/2

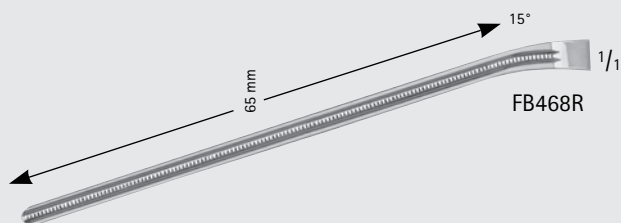
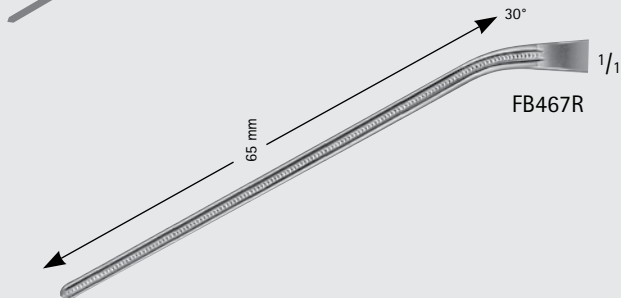
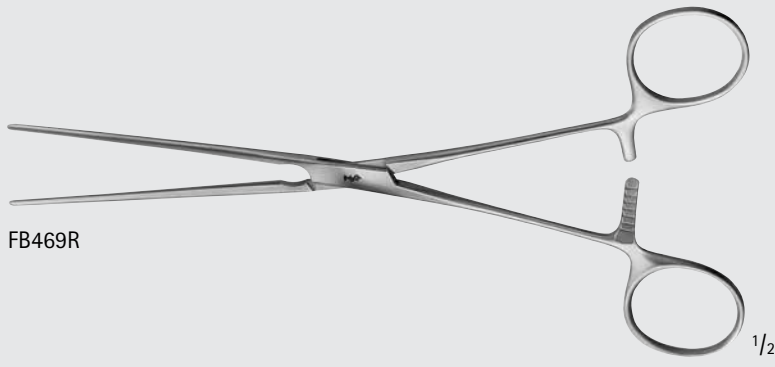

Cardiovascular

Vascular Clamps

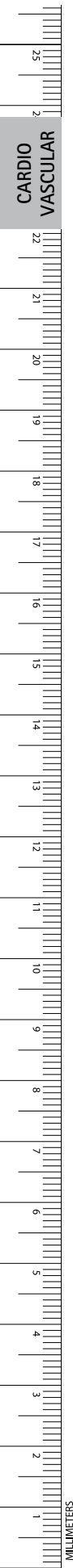

CARDIO
VASCULAR

DEBAKEY Atraumatic Suture Forceps

Catalog Number	Jaw	Jaw Length (mm)	Shaft	Length (in.)
FB483R	CVD	94	CVD	9 1/2

FB483R

94 mm

18 mm

1/1

1/2

1/2

DIETHRICH Atraumatic Aortic Clamp

Catalog Number	Jaw Angle	Jaw Length (mm)	Length (in.)
FB525R	MULTI	45	8 1/4

FB525R

75 mm

45 mm

1/1

1/2

1/2

DEBAKEY Atraumatic Forceps

Catalog Number	Jaw	Jaw Length (mm)	Length (in.)
FB484R	C-CURVE	77	7 1/2
FB498R	C-CURVE	51	8 1/4
FB485R	D-CURVE	80	9
FB499R	D-CURVE	75	9

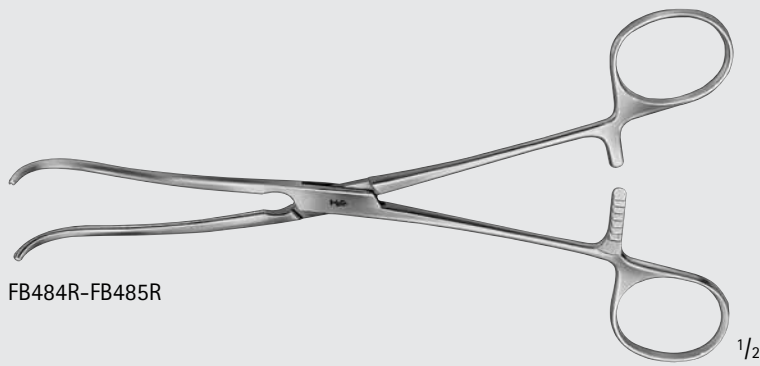

FB484R-FB485R

1/2



FB484R

1/1

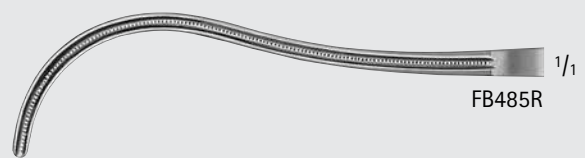

FB485R

1/1



FB498R

1/1



FB499R

1/1

HENLY Atraumatic Clamp

Catalog Number	Jaw Length (mm)	Length (in.)
FB617R	75	7 7/8

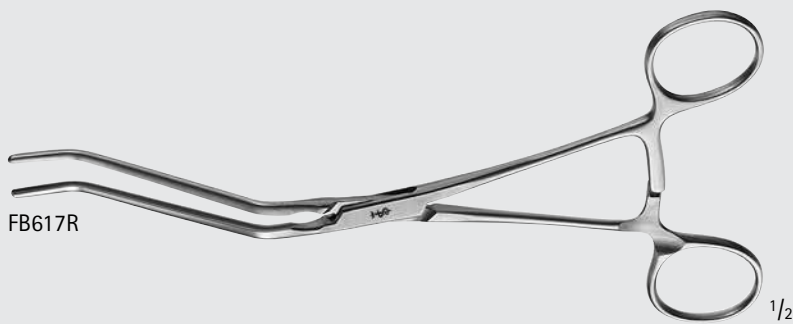

FB617R

1/2



1/2

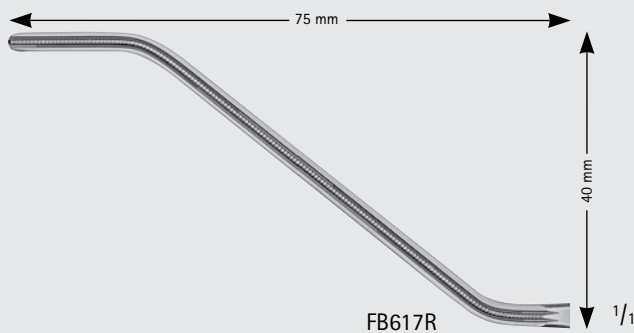

FB617R

1/1

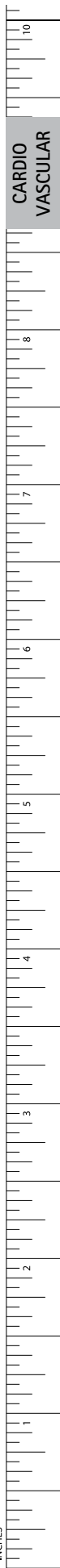

Cardiovascular

Vascular Clamps

CARDIO
VASCULAR

25
24
23
22
21
20
19
18
17
16
15
14
13
12
11
10
9
8
7
6
5
4
3
2
1
MILLIMETERS

DEBAKEY-RUMEL Atraumatic Forceps

Catalog Number	Jaw	Jaw Length (mm)	Length (in.)
FB486R	SIGHT-CVD	81	9 3/4
FB487R	CVD	81	9 5/8

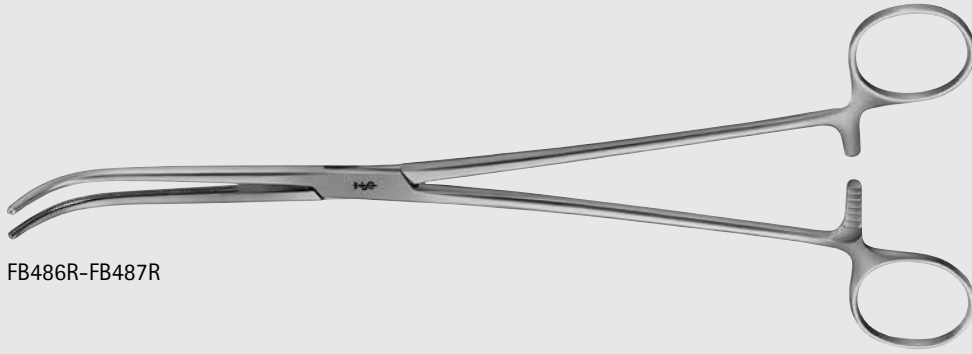

FB486R-FB487R



FB486R



FB487R

LEES Atraumatic Bronchus Clamp

Catalog Number	Jaw Angle	Jaw Length (mm)	Length (in.)
FB573R	90°	42	8 3/4

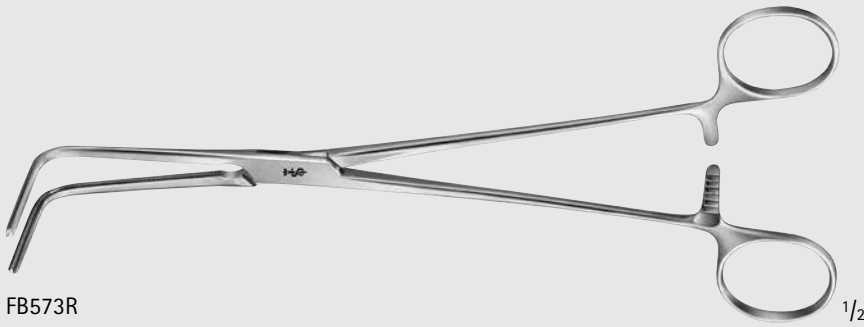

FB573R

1/2



90°

42 mm

1/1

FB573R

LEES Atraumatic Bronchus Clamp

Catalog Number	Jaw Angle	Jaw Length (mm)	Shaft	Length (in.)
FB574R	ANG	40	CVD	9 5/8

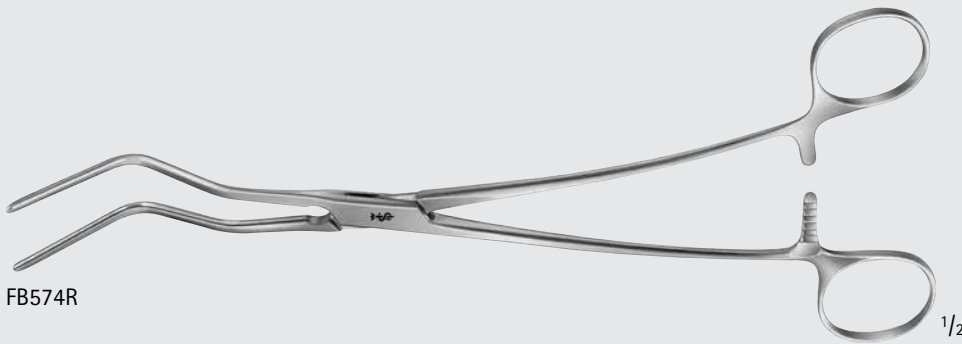

FB574R

1/2

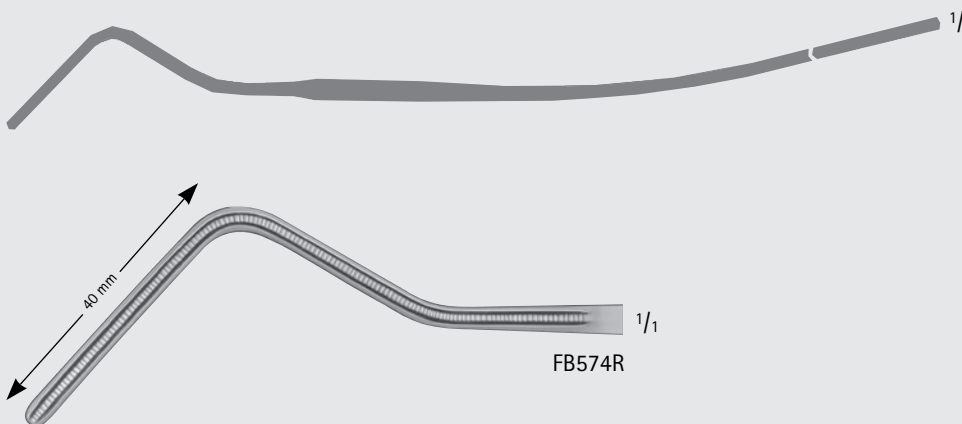

40 mm

1/1

FB574R



INCHES

Cardiovascular

Vascular Clamps

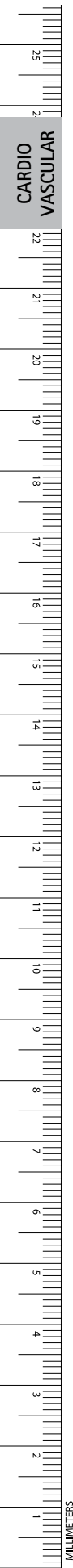

CARDIO
VASCULAR

DEBAKEY Atraumatic Multi-Purpose Clamp

Catalog Number	Jaw Angle	Jaw Length (mm)	Length (in.)
FB510R	60°	40	9 1/2
FB511R	60°	55	8 3/4
FB512R	60° <td 65	11	
FB513R	60°	100	12

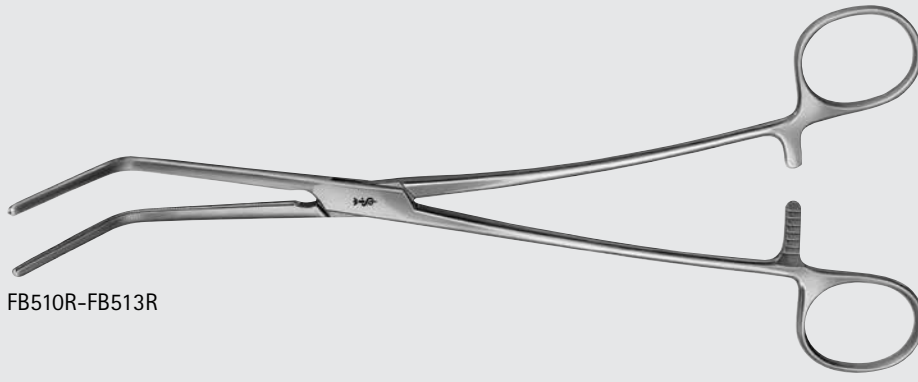

FB510R-FB513R

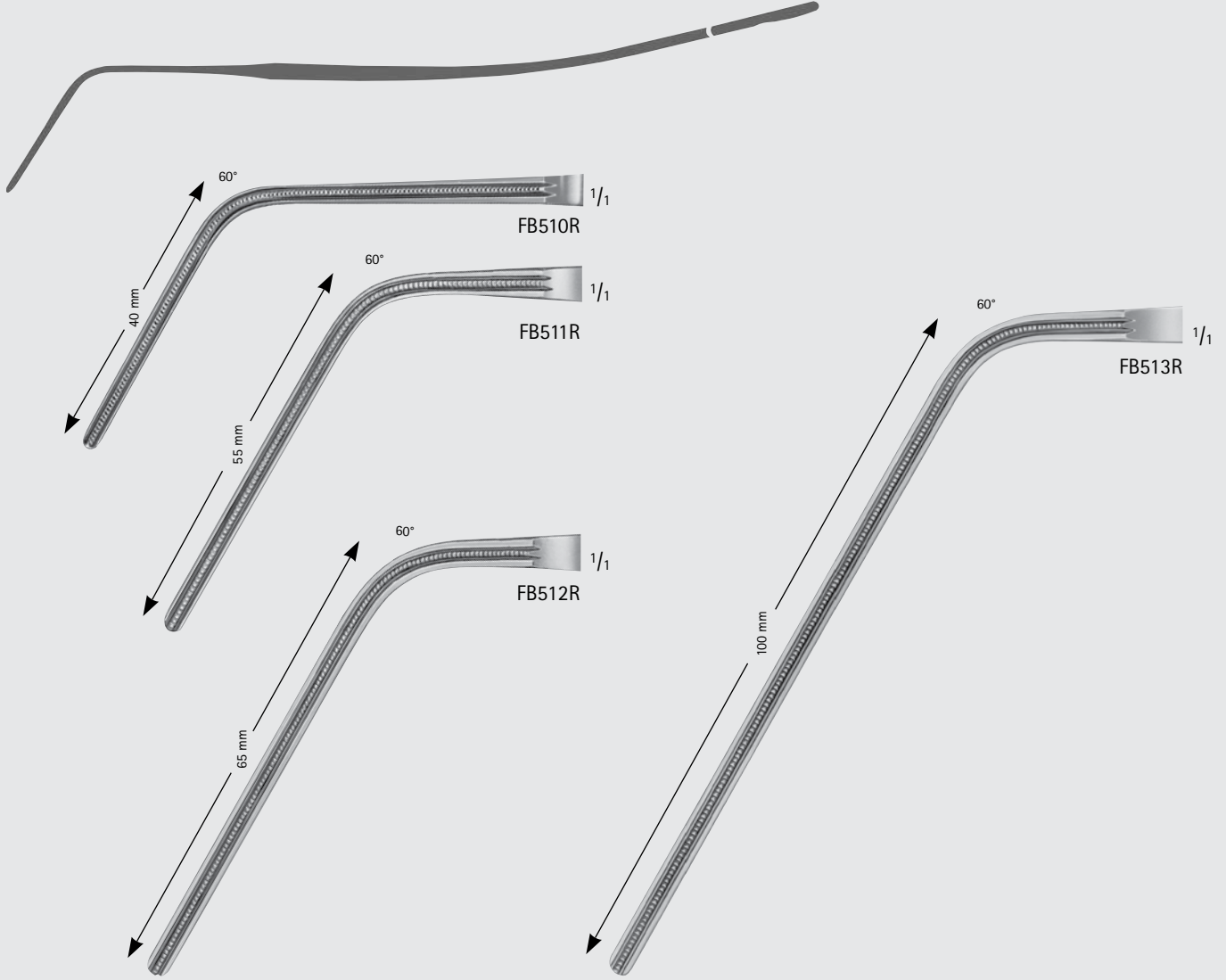

DEBAKEY Atraumatic Multi-Purpose
Clamp

Catalog Number	Jaw Angle	Jaw Length (mm)	Length (in.)
FB515R	90°	45	8 7/8
FB516R	90°	55	8 1/4
FB517R	90°	72	10
FB518R	90°	108	10 3/4

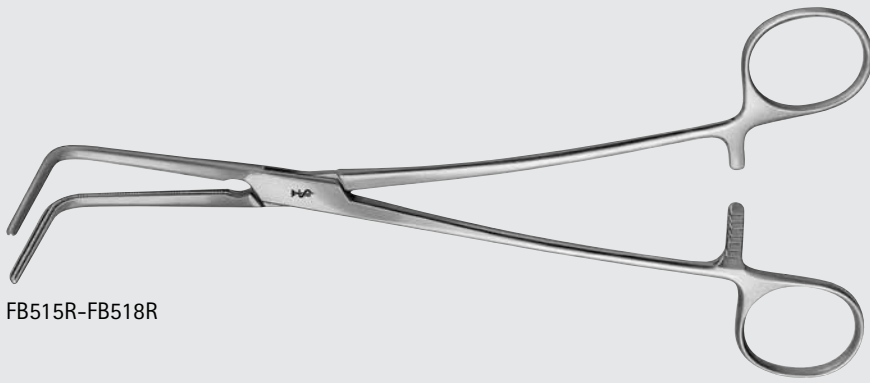

FB515R-FB518R

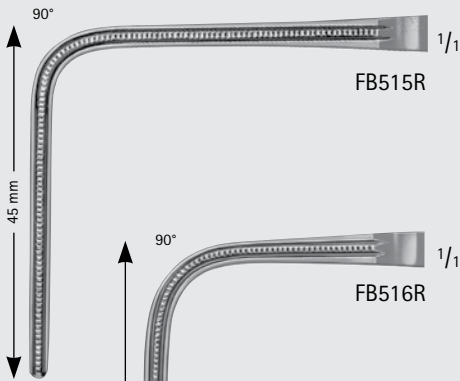

FB515R

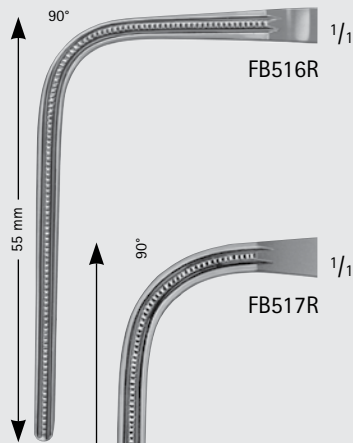

FB516R

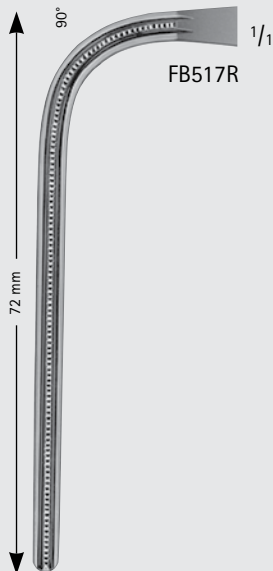

FB517R

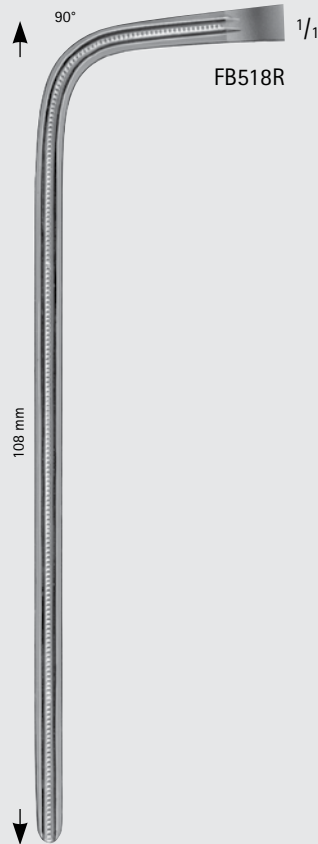

FB518R



Cardiovascular

Vascular Clamps

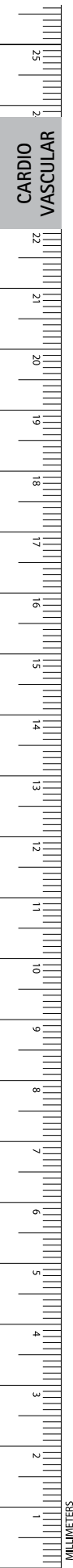

CARDIO
VASCULAR

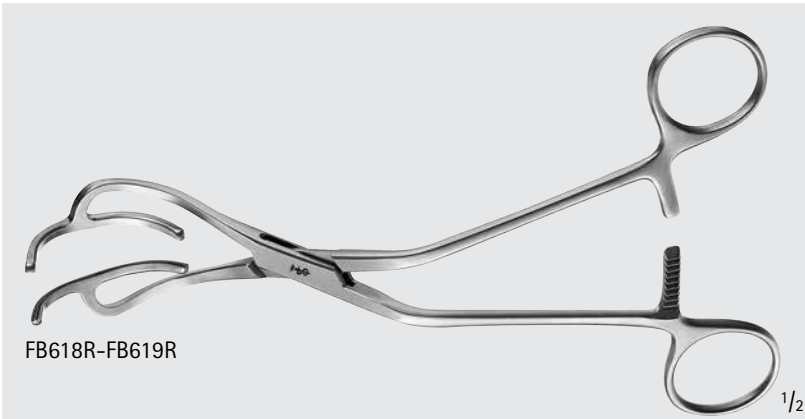

LEMOLE-STRONG Atraumatic Clamp, Angled Shaft

Catalog Number	Jaw Size (mm)	Length (in.)
FB618R	40 x 15	7 7/8
FB619R	45 x 20	7 7/8

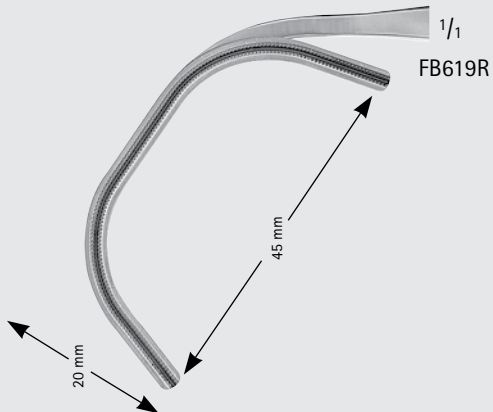
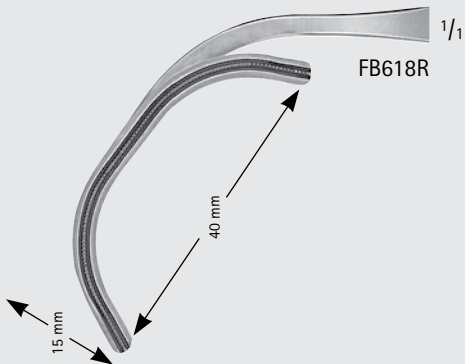

Cardiovascular Vascular Clamps

STRONG Aorta Clamp, Straight Shaft

Catalog Number	Jaw	Length (in.)
MG074R	CVD	7 7/8

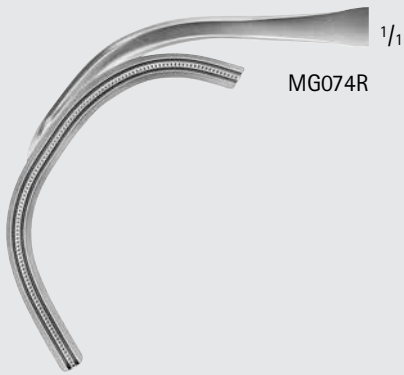
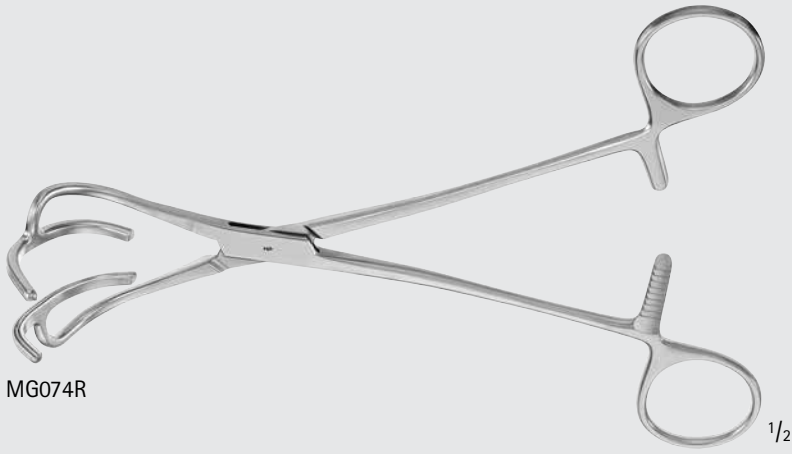

Cardiovascular

Vascular Clamps

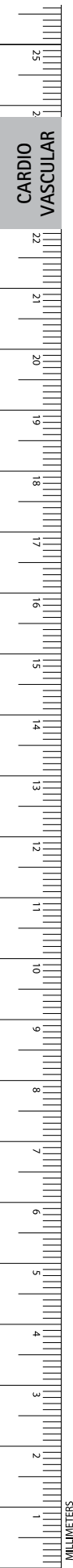

CARDIO
VASCULAR

WYLIE Hypogastric Clamp

Catalog Number	Jaw	Jaw Length (mm)	Shaft	Length (in.)
MB241	CVD	70	ANG	8 1/2
MB240	CVD	75	ANG	9 3/4



MB240-MB241

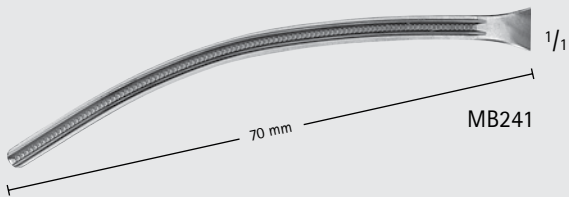

MB241

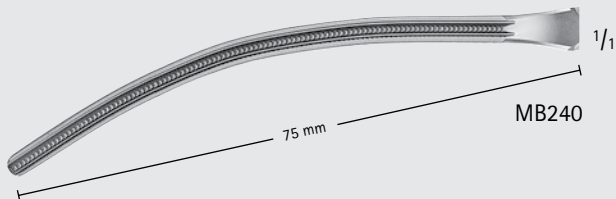

MB240

Cardiovascular Vascular Clamps

WYLIE Atraumatic Clamp

Catalog Number	Jaw	Length (in.)
FB669R	HEAVY-CVD	8 3/4
FB670R	CVD-BACK	9

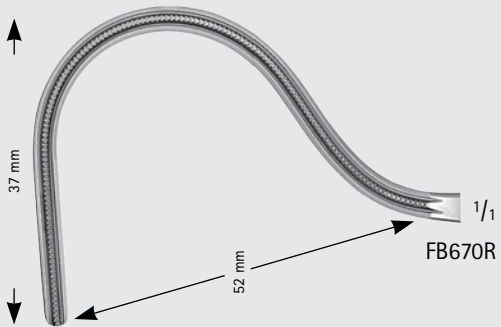
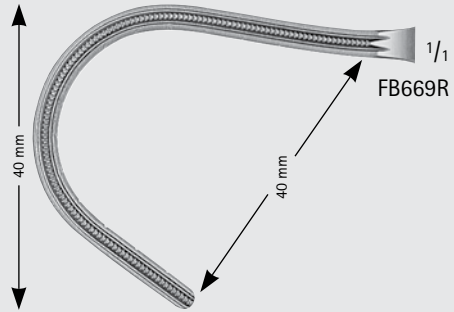

Cardiovascular

Vascular Clamps

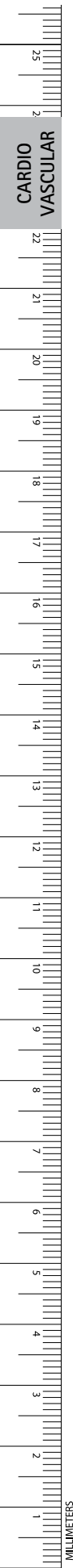

CARDIO
VASCULAR

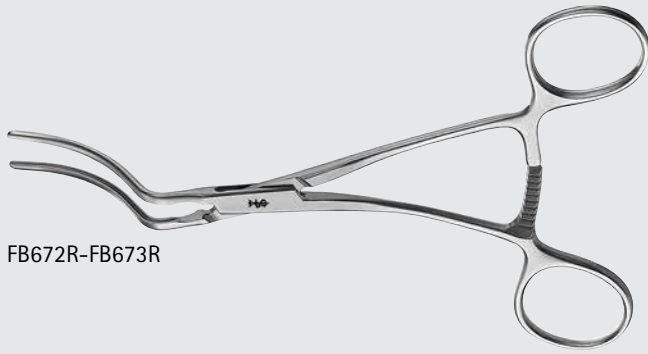

FB672R-FB673R

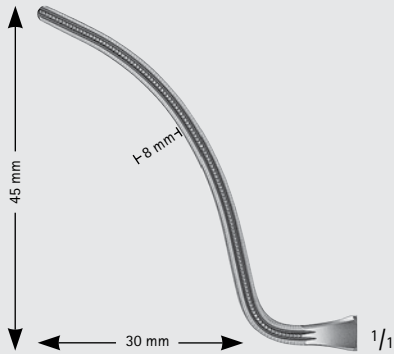

FB672R

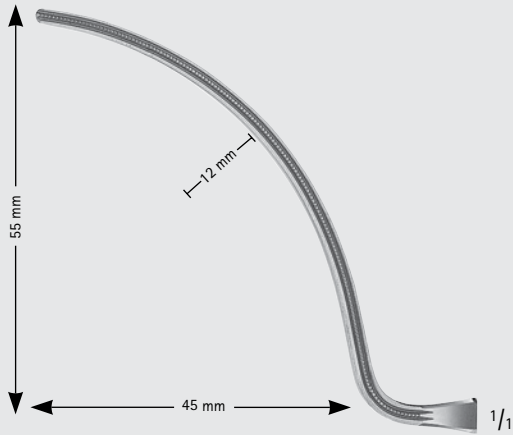

FB673R

WYLIE Atraumatic Clamp

Catalog Number	Jaw	Length (in.)
FB672R	CVD-UP	6 1/4
FB673R	CVD-UP	7

WYLIE Atraumatic Clamp

Catalog Number	Jaw	Length (in.)
FB674R	CVD-DOWN	6
FB675R	CVD-DOWN	6 1/2

FB674R-FB675R

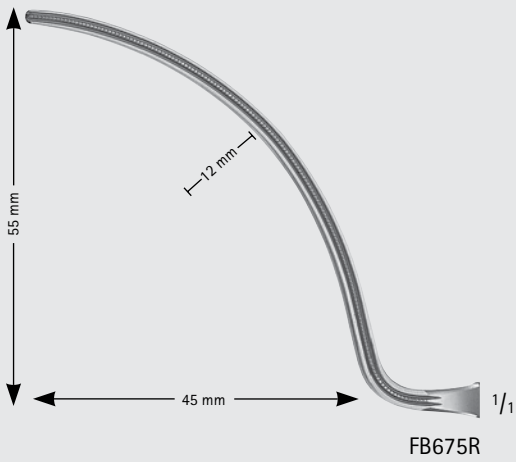
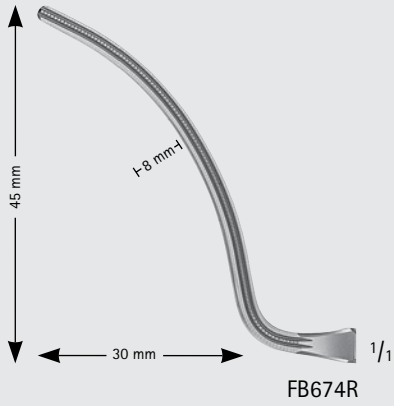
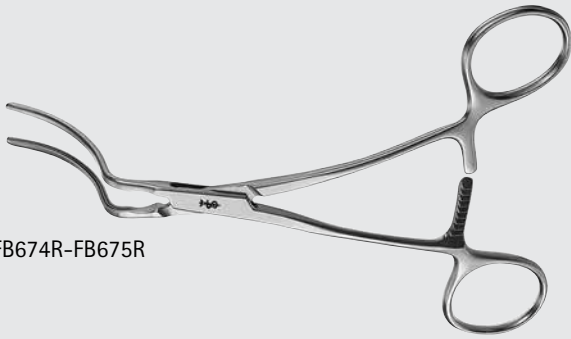

INCHES

Cardiovascular

Vascular Clamps

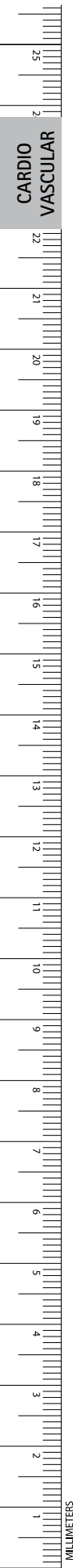

CARDIO
VASCULAR

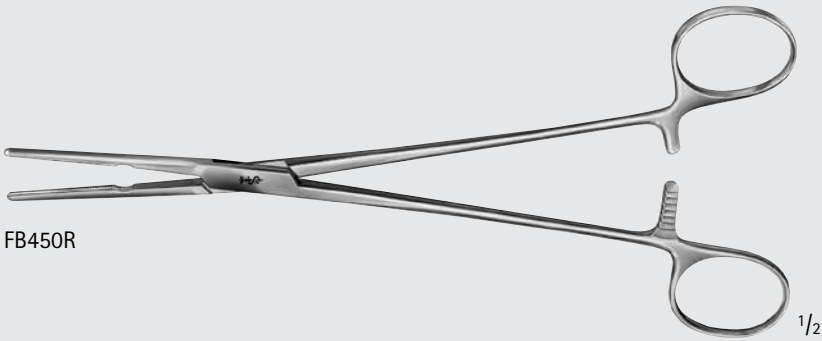

FB450R

1/2



1/1

51 mm

FB450R

DEBAKEY Atraumatic Patent Ductus Clamp

Catalog Number	Jaw Length (mm)	Shaft	Length (in.)
FB450R	51	STR	8 1/4
FB451R	51	ANG	8 1/4

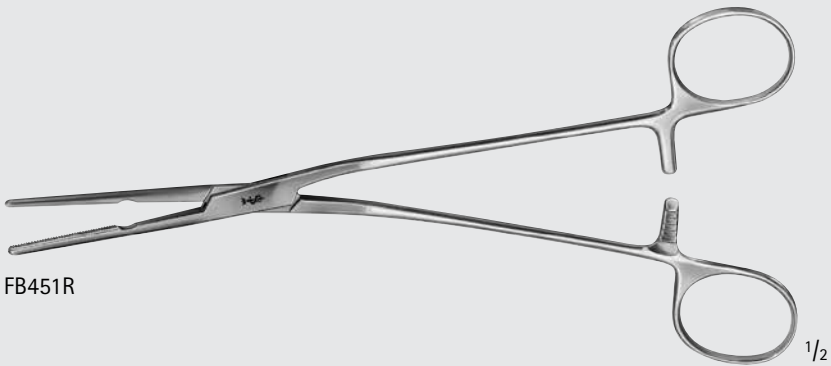

FB451R

1/2

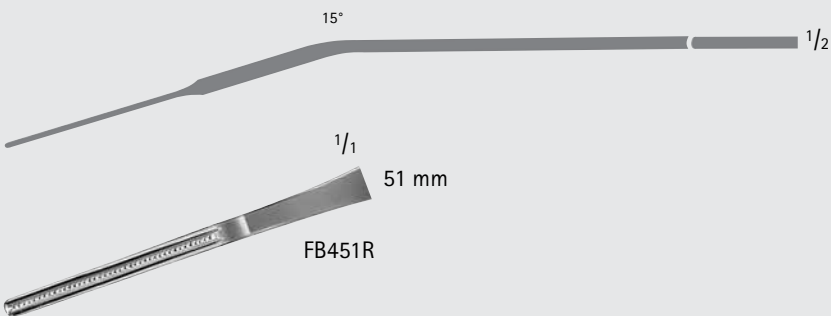

15°

1/2

1/1

51 mm

FB451R

Cardiovascular

Vascular Clamps

DEBAKEY Atraumatic Coarctation Clamp

Catalog Number	Jaw Length (mm)	Shaft	Length (in.)
FB453R	41	ANG	7 7/8
FB553R	50	ANG	6 1/2
FB455R	65	ANG	8 7/8
FB457R	80	ANG	9 1/2

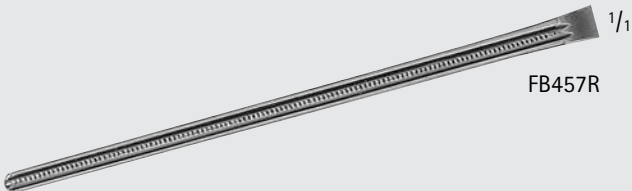
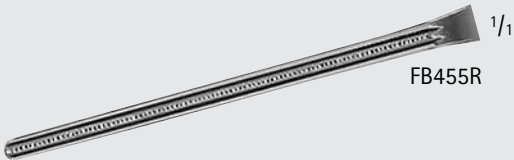
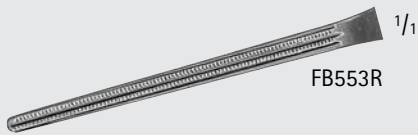
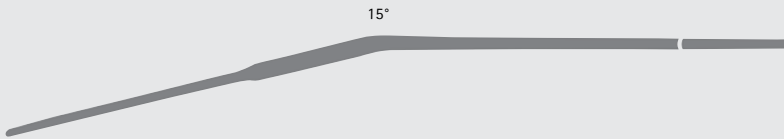

Cardiovascular

Vascular Clamps



CARDIO
VASCULAR

FB452R-FB552R

FB452R $\frac{1}{1}$

FB552R $\frac{1}{1}$

FB454R $\frac{1}{1}$

FB456R $\frac{1}{1}$

Catalog Number	Jaw	Jaw Length (mm)	Length (in.)
FB452R	STR	41	8
FB552R	STR	50	6 3/4
FB454R	STR	65	8 7/8
FB456R	STR	80	9 1/2

MG423R $\frac{1}{2}$

MG423R $\frac{1}{1}$

Catalog Number	Jaw Angle	Length (in.)
MG423R	50°	4 3/4

Cardiovascular

Vascular Clamps

GLOVER Atraumatic Clamp

Catalog Number	Jaw	Jaw Length (mm)	Length (in.)
FB458R	CVD	65	8 1/2
FB460R	SPOON SHAPED	60	8 3/4
FB550R	SPOON SHAPED	70	9 5/8
FB459R	CVD	86	9 5/8
FB461R	FULL-CVD	47	7 3/4
FB462R	FULL-CVD	63	8 1/4



FB458R-FB550R

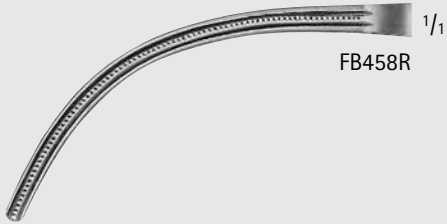

FB458R

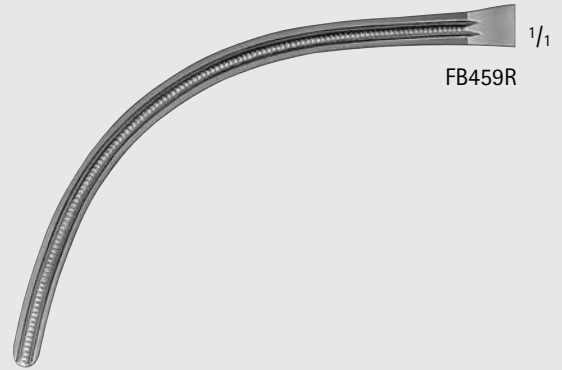

FB459R



FB460R

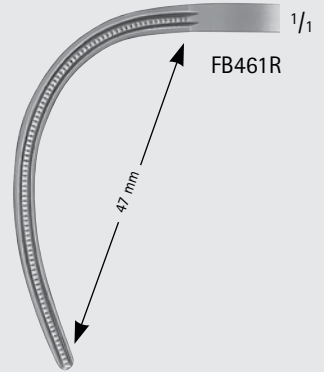

FB461R



FB550R

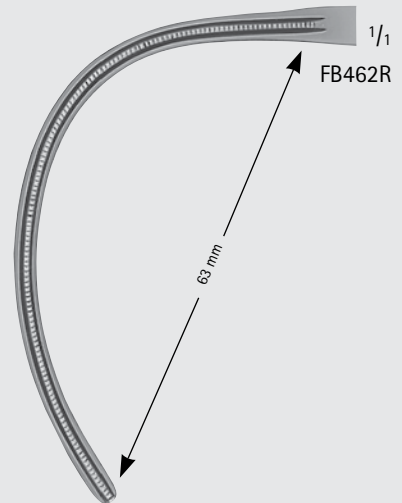

FB462R

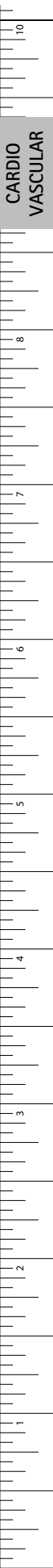

Cardiovascular

Vascular Clamps

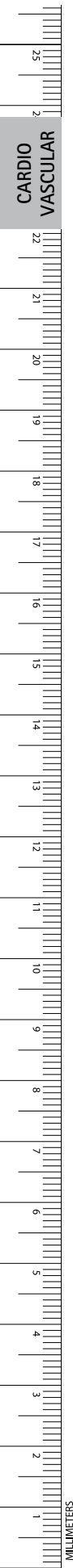

CARDIO
VASCULAR

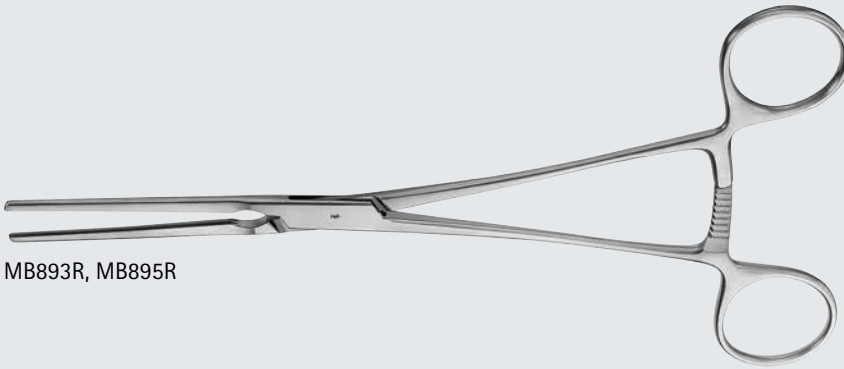

MB893R, MB895R



MB893R



MB895R

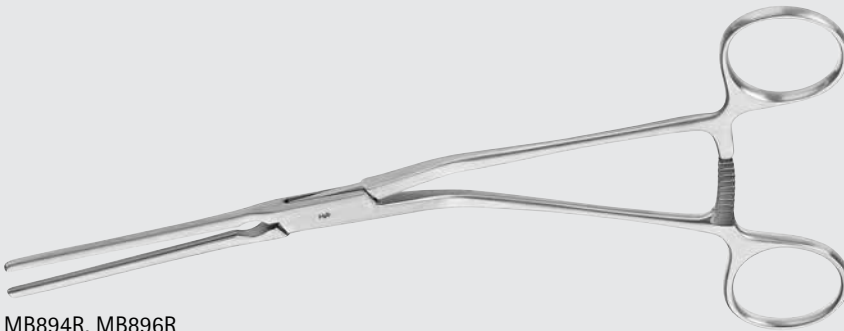

MB894R, MB896R



MB894R



MB896R

GLOVER Coarctation Clamp

Catalog Number	Jaw	Jaw Length (mm)	Length (in.)
MB893R	STR	60	9
MB895R	STR	70	10 1/4
MB894R	ANG	60	8 3/4
MB896R	ANG	70	10

Cardiovascular

Vascular Clamps

GREGORY Atraumata Profunda Clamp

Catalog Number	Jaw	Jaw Length (mm)	Length (in.)
MG014R	X-SMALL	29	5
MB750R	SMALL	57	5 3/4
MB751R	MEDIUM	62	7
MB752R	LARGE	75	7 3/4

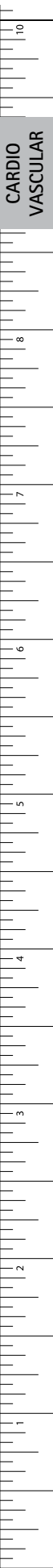
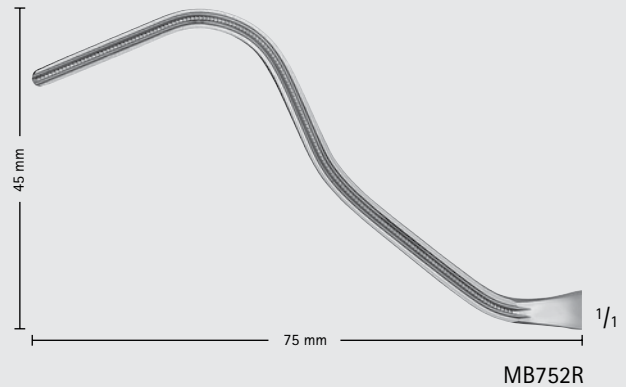
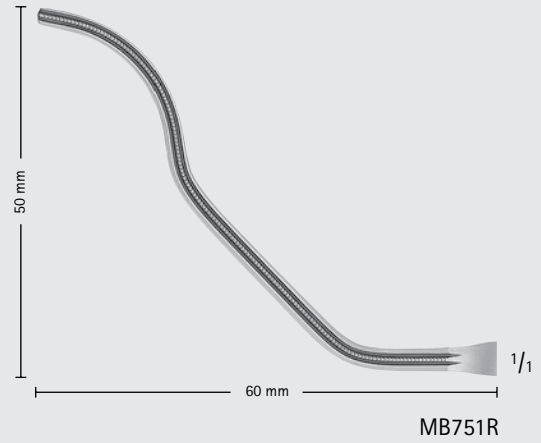
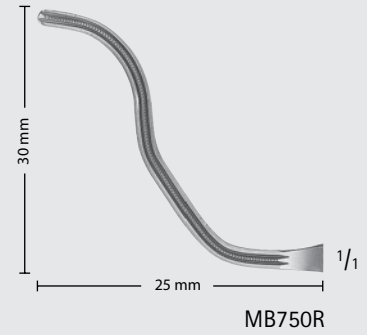
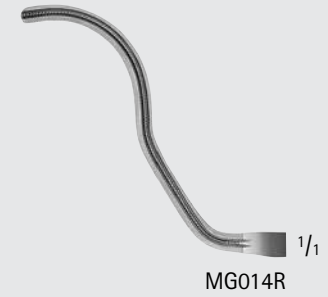
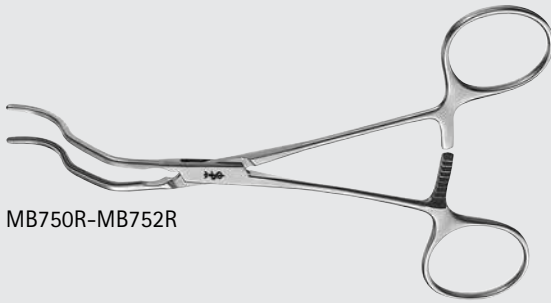
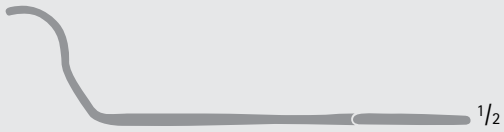
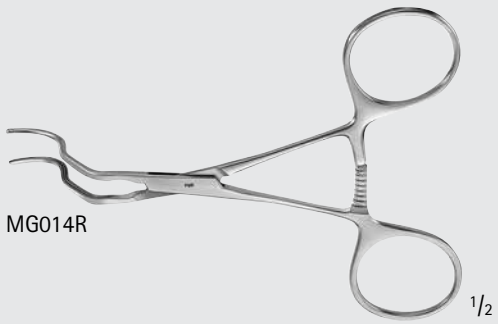

Cardiovascular

Vascular Clamps

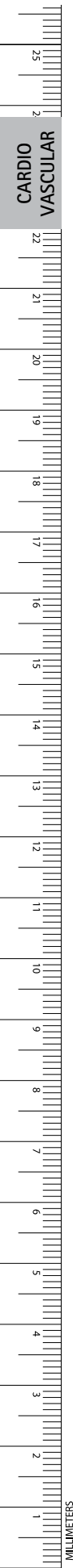

CARDIO
VASCULAR

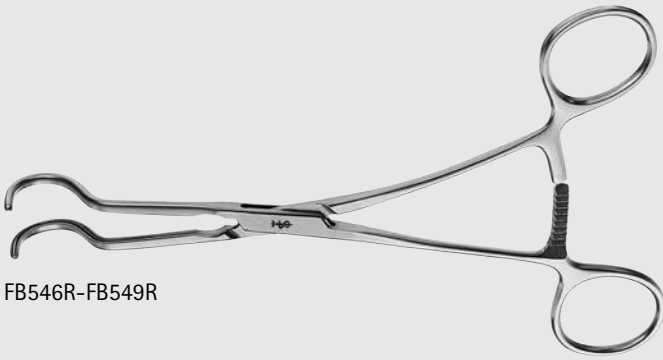

FB546R-FB549R

DALE Femoral Popliteal Clamp

Catalog Number	Jaw	Length (in.)
FB546R	SMALL	6 7/8
FB547R	MEDIUM	7
FB548R	LARGE	7
FB549R	-	7

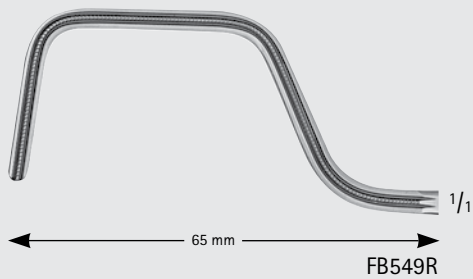
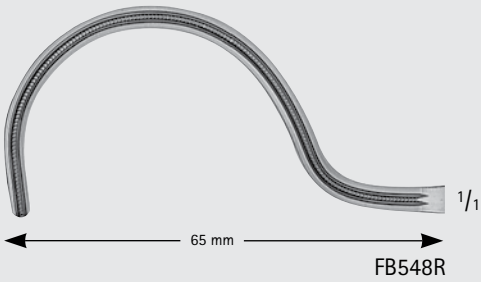
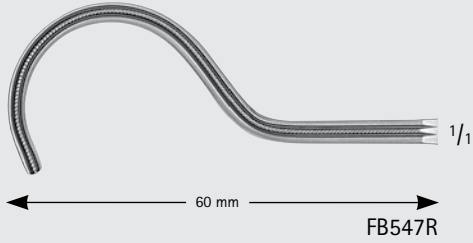
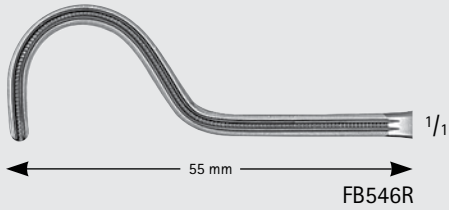

SELMAN Vessel Forceps

Catalog Number	Jaw	Jaw Length (mm)	Length (in.)
MG361R	STR, COOLEY SERR	25	5 1/4
MG362R	ANG, COOLEY SERR	25	5 1/4

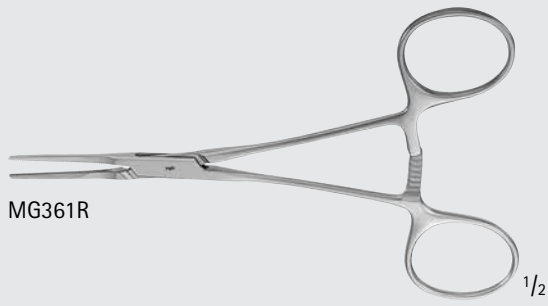

MG361R



MG361R

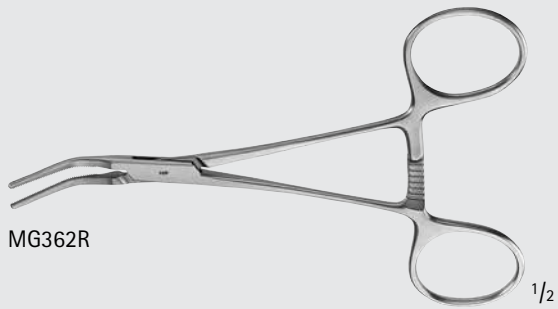

MG362R



MG362R



INCHES

Cardiovascular

Vascular Clamps



CARDIO
VASCULAR

CHERRY Clamp

Catalog Number	Jaw	Teeth	Shaft	Length (in.)
MG368R	CVD	2 x 3	60° ANG	12 3/8

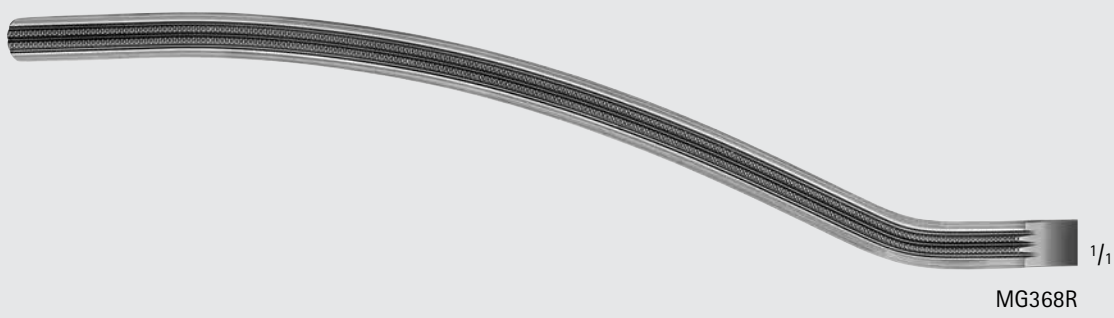
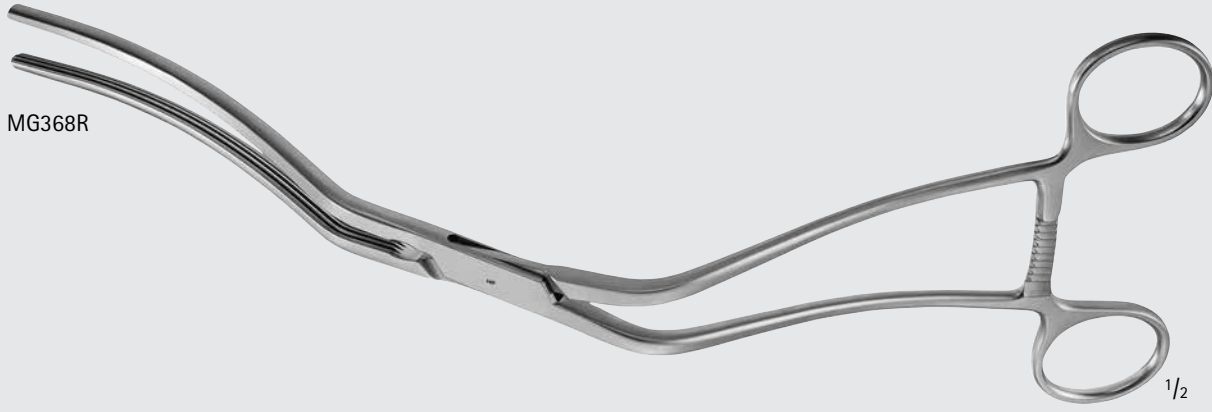

Cardiovascular

Vascular Clamps



DEBAKEY Atraumatic Peripheral Clamp #1

Catalog Number	Jaw Length (mm)	Length (in.)
FB463R	56	6 1/4

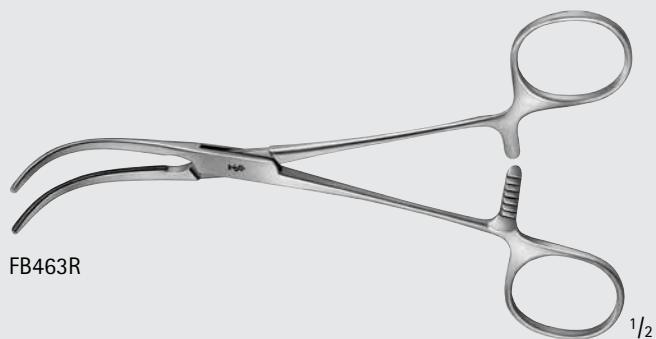

FB463R

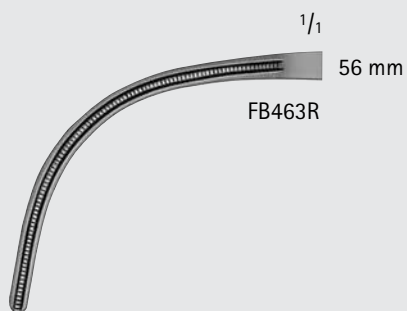

DEBAKEY Atraumatic Peripheral Clamp #2

Catalog Number	Jaw Length (mm)	Length (in.)
FB464R	90	7 1/2

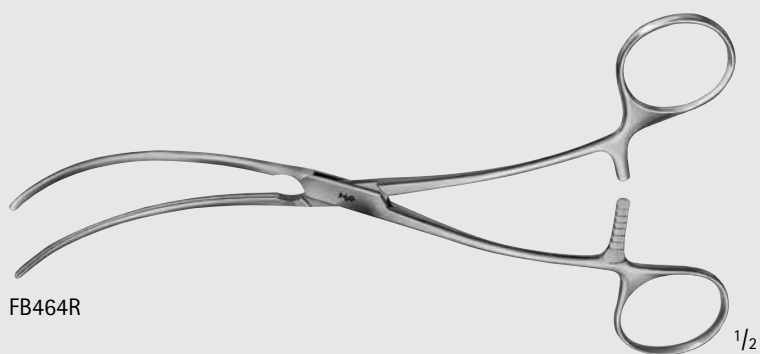

FB464R

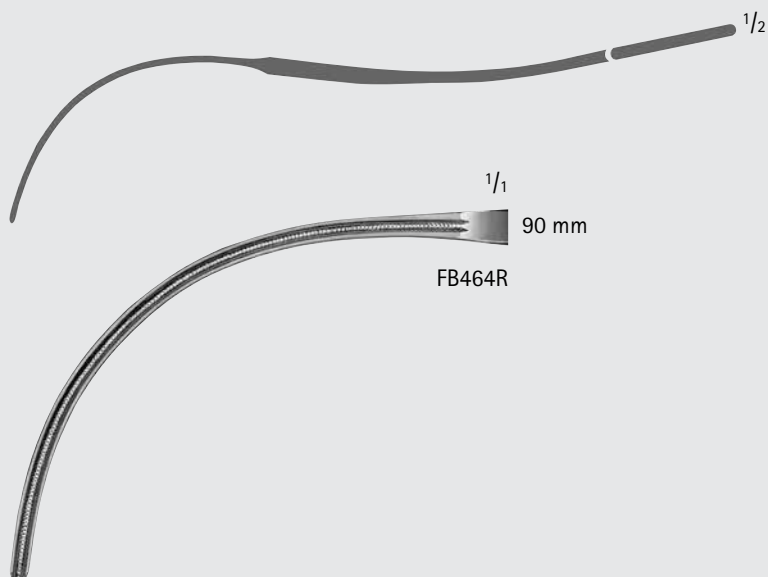

Cardiovascular

Vascular Clamps

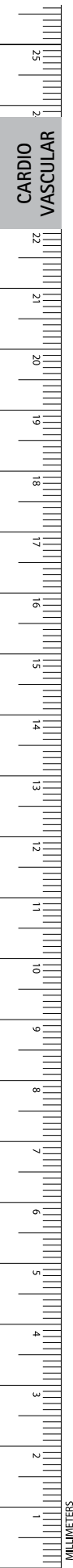

CARDIO
VASCULAR

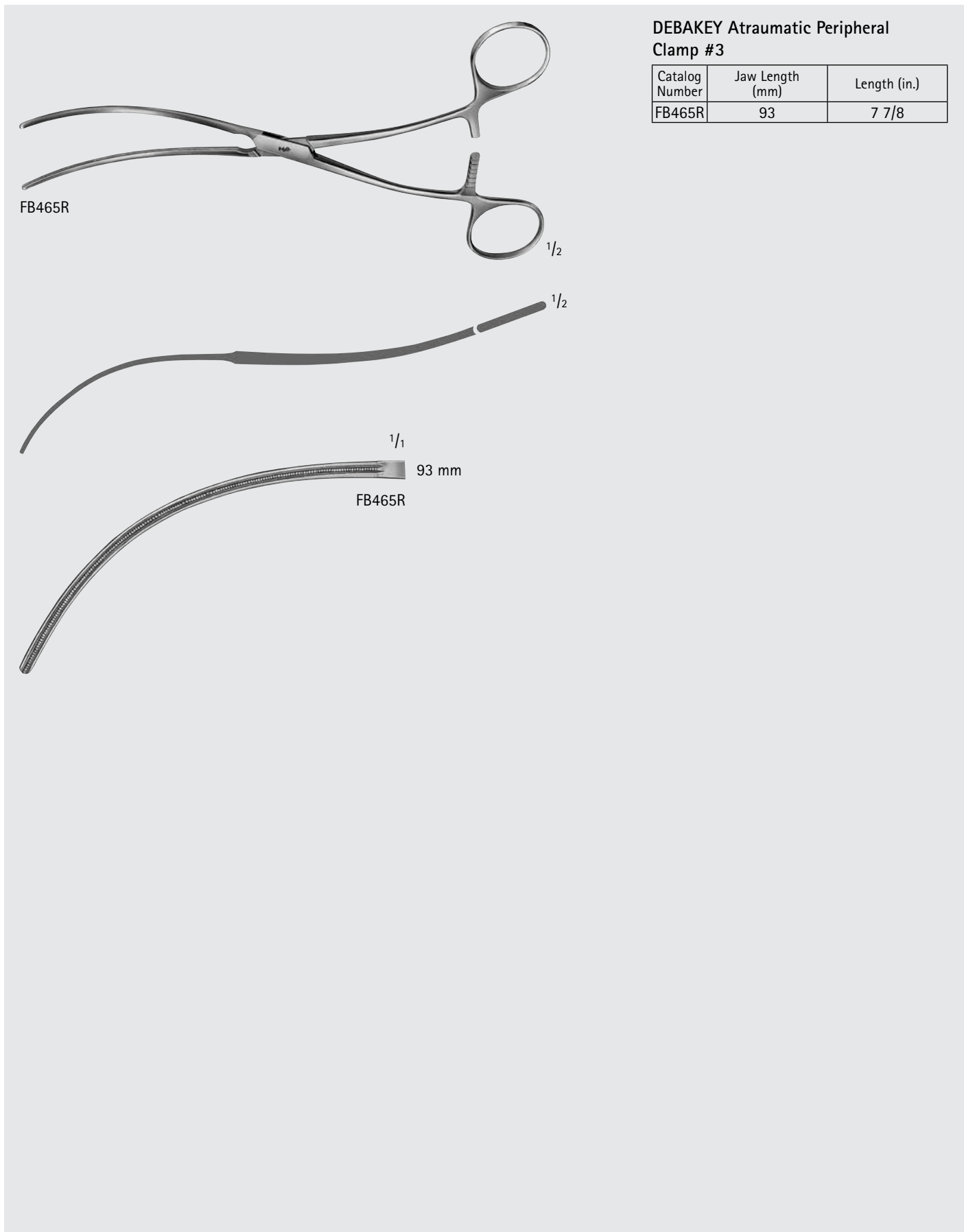

**DEBAKEY Atraumatic Peripheral
Clamp #3**

Catalog Number	Jaw Length (mm)	Length (in.)
FB465R	93	7 7/8

FB465R

1/2

1/2

1/1

93 mm

FB465R

Cardiovascular Vascular Clamps

DEBAKEY Atraumatic Peripheral Clamp #4

Catalog Number	Jaw Angle	Jaw Length (mm)	Length (in.)
FB466R	60°	77	7

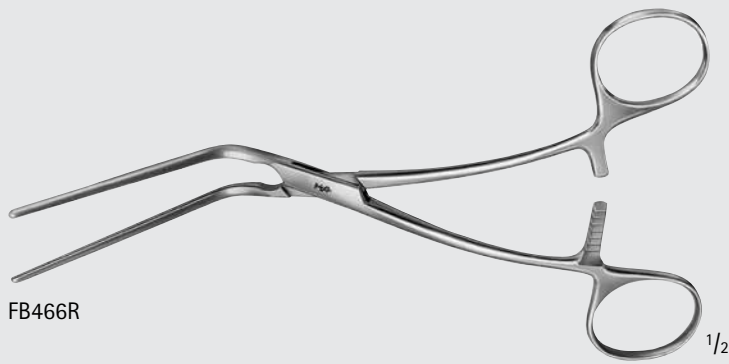

FB466R

1/2

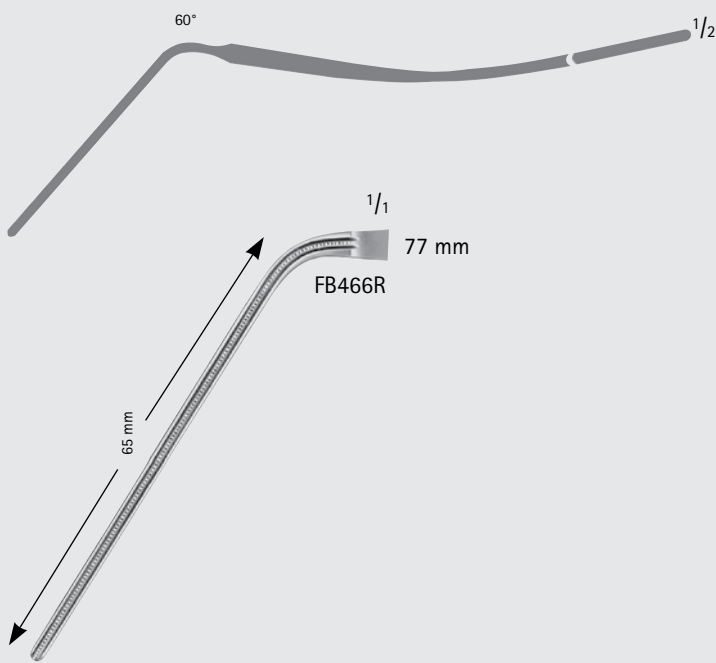

60°

1/2

1/16

77 mm

FB466R

65 mm

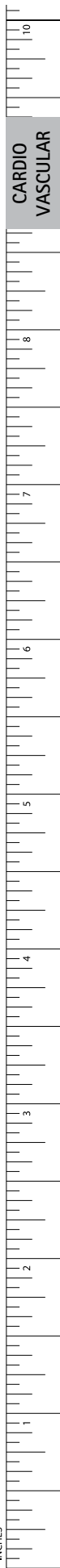

INCHES

Cardiovascular

Vascular Clamps



CARDIO
VASCULAR

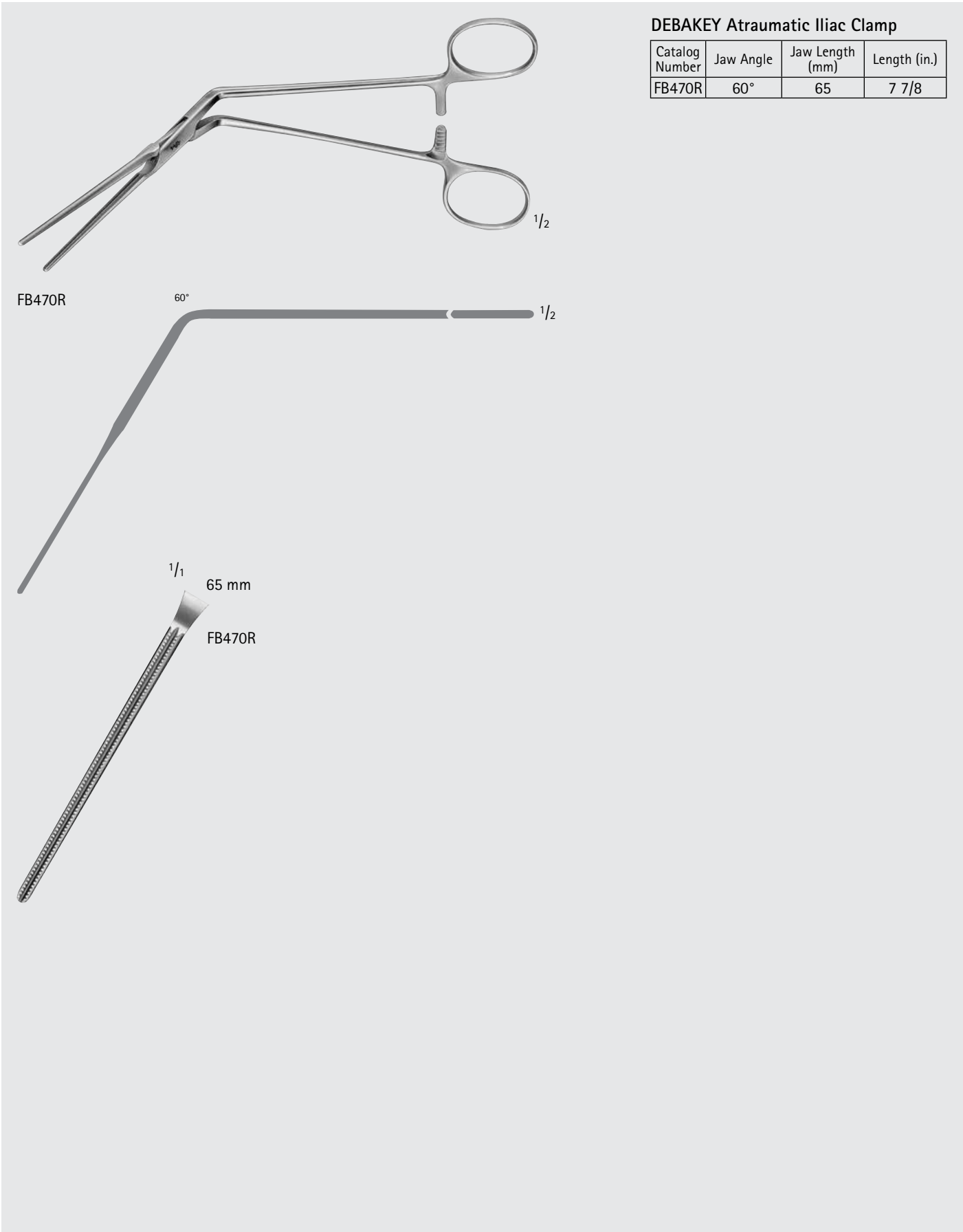

DEBAKEY Atraumatic Iliac Clamp

Catalog Number	Jaw Angle	Jaw Length (mm)	Length (in.)
FB470R	60°	65	7 7/8

Cardiovascular

Vascular Clamps

COOLEY Aortic Aneurysm Clamp

Catalog Number	Jaw	Jaw Length (mm)	Length (in.)
MG448R	CVD	75	10

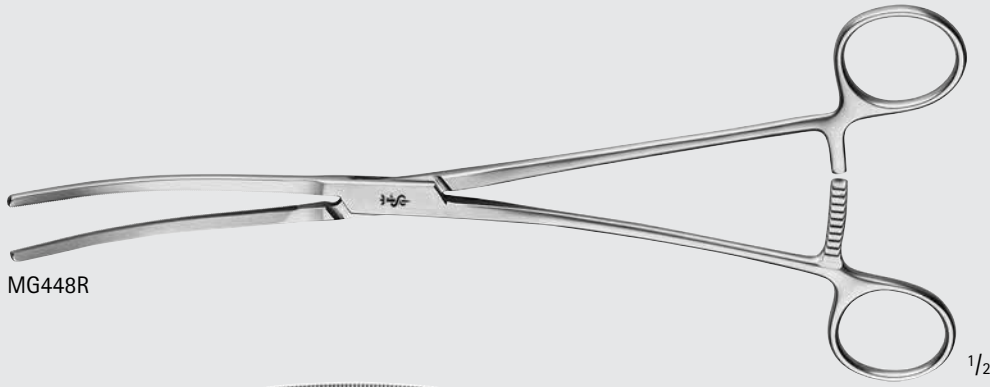

MG448R



MG448R



Cardiovascular

Vascular Clamps

DEBAKEY Atraumatic Aortic Aneurysm Clamp, Light Curved

Catalog Number	Jaw	Jaw Length (mm)	Length (in.)
FB471R	2 x 3 SERR	95	9 3/4
FB472R	2 x 3 SERR	110	11 3/4
FB473R	2 x 3 SERR	130	12 3/8
FB480R	2 x 3 SERR	140	12 3/4

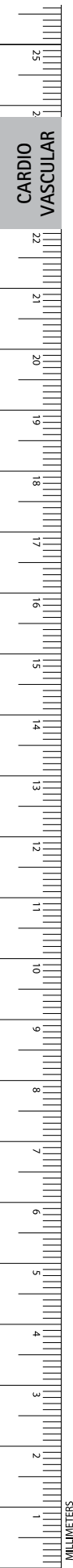
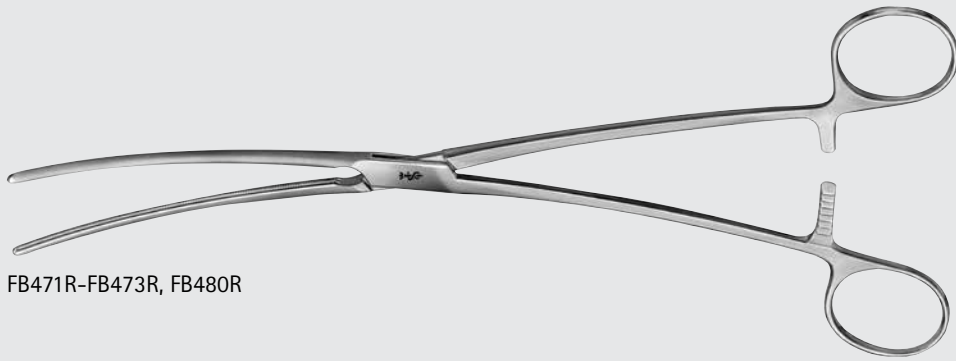

Cardiovascular

Vascular Clamps

DEBAKEY Atraumatic Aortic Aneurysm Clamp

Catalog Number	Jaw	Jaw Length (mm)	Length (in.)
FB478R	SLIGHT-CVD	70	10
FB477R	CVD	75	10 1/2
FB476R	HEAVY-CVD	85	11

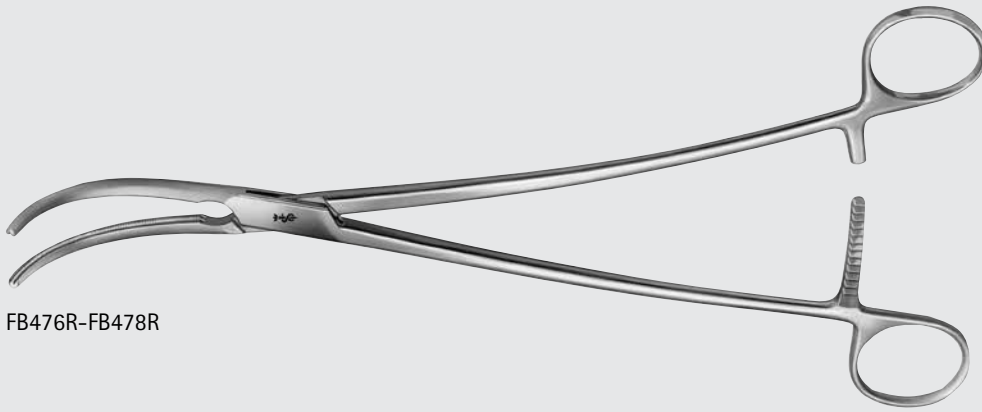

FB476R-FB478R

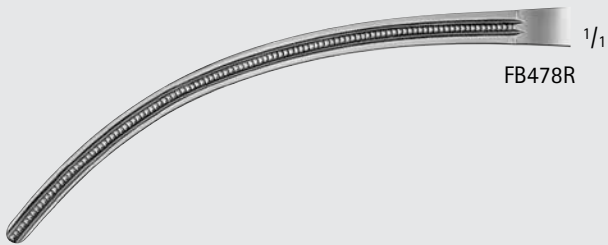

FB478R

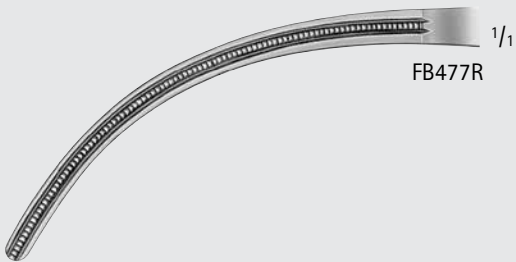

FB477R

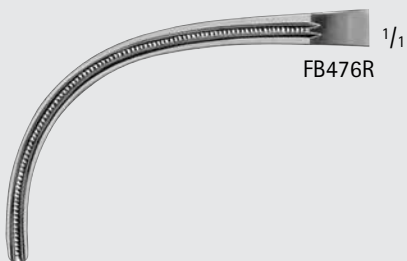

FB476R



Cardiovascular

Vascular Clamps

DEBAKEY Atraumatic Aortic Aneurysm Clamp, S-Curved

Catalog Number	Jaw Length (mm)	Length (in.)
FB475R	115	11 3/4

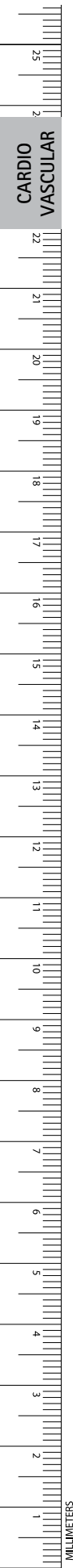
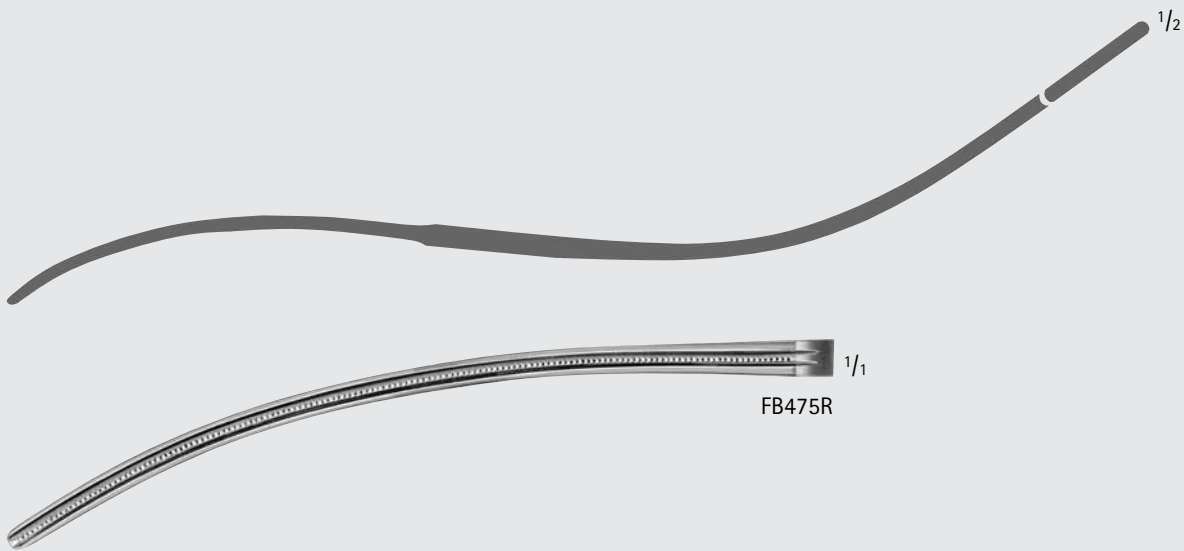
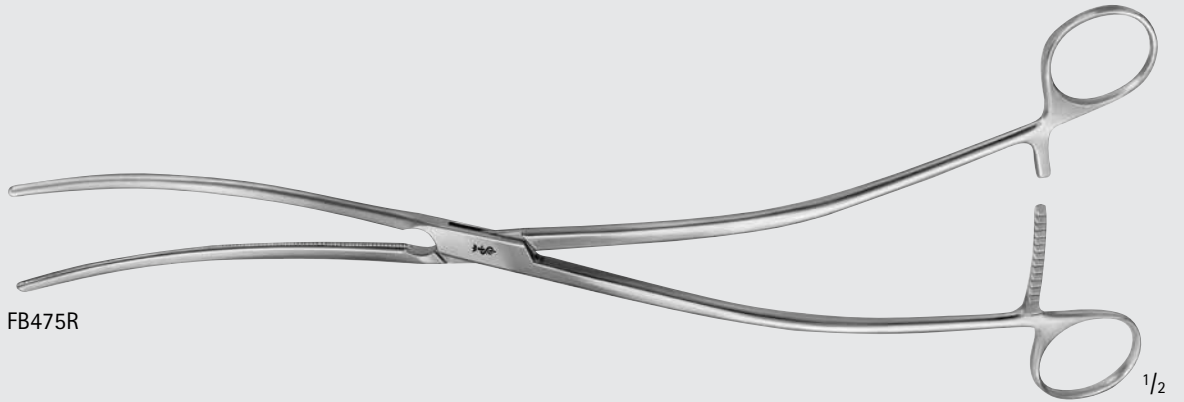

Cardiovascular

Vascular Clamps

DEBAKEY-SEMB Atraumatic Aortic Aneurysm Clamp, Curved

Catalog Number	Jaw Length (mm)	Length (in.)
FB482R	100	10 1/2

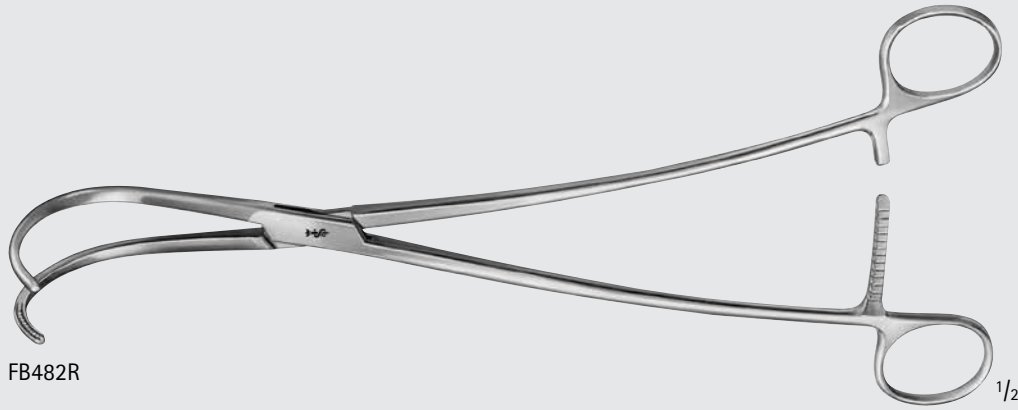

Cardiovascular

Vascular Clamps

DEBAKEY Atraumatic Aortic Aneurysm Clamp, Full Curved

Catalog Number	Jaw Length (mm)	Length (in.)
FB481R	111	10 5/8



FB481R

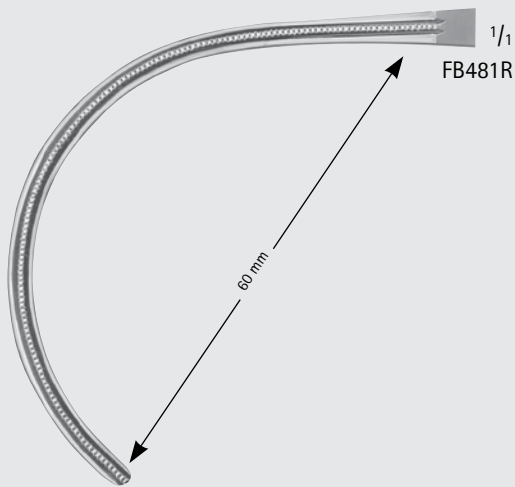

60 mm

FB481R

1/1

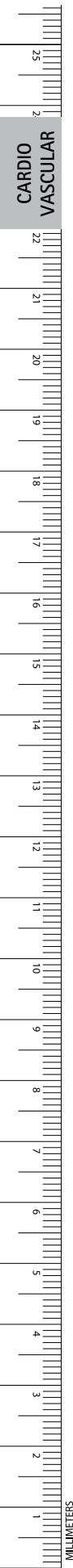

Cardiovascular

Vascular Clamps

WEBER Atraumatic Aortic Clamp, Left

Catalog Number	Jaw Length (mm)	Length (in.)
FB488R	113	10 1/4

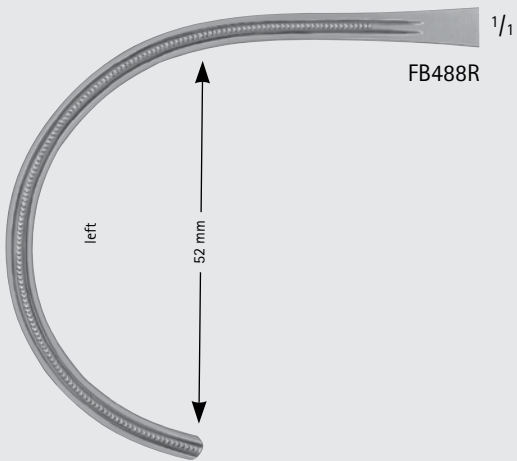
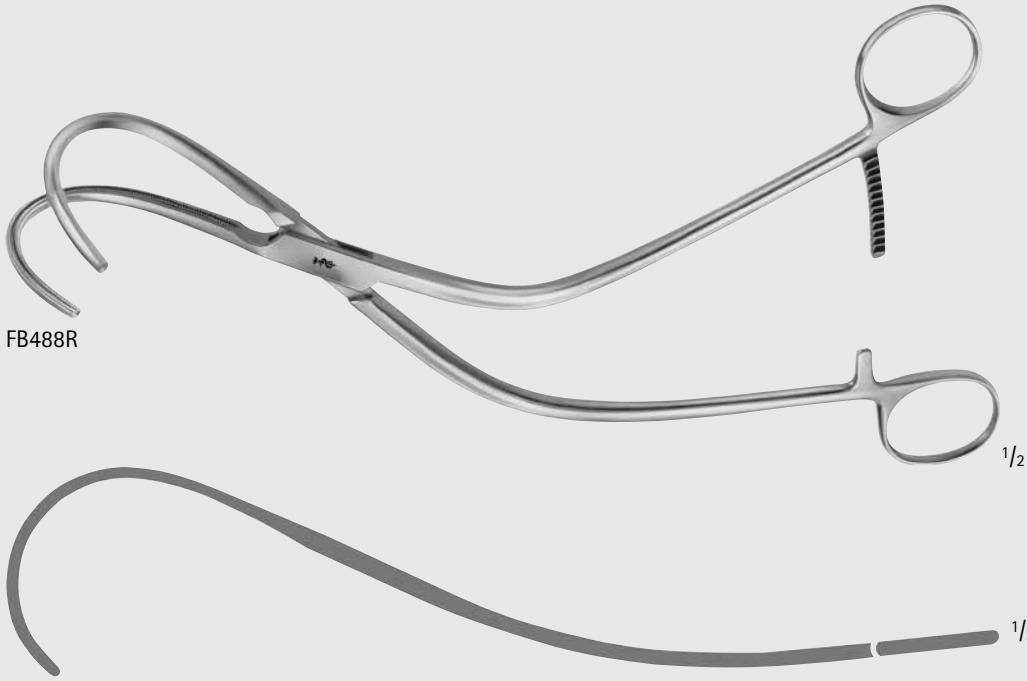

Cardiovascular

Vascular Clamps

WEBER Atraumatic Aortic Clamp, Right

Catalog Number	Jaw Length (mm)	Length (in.)
FB489R	113	10 1/4

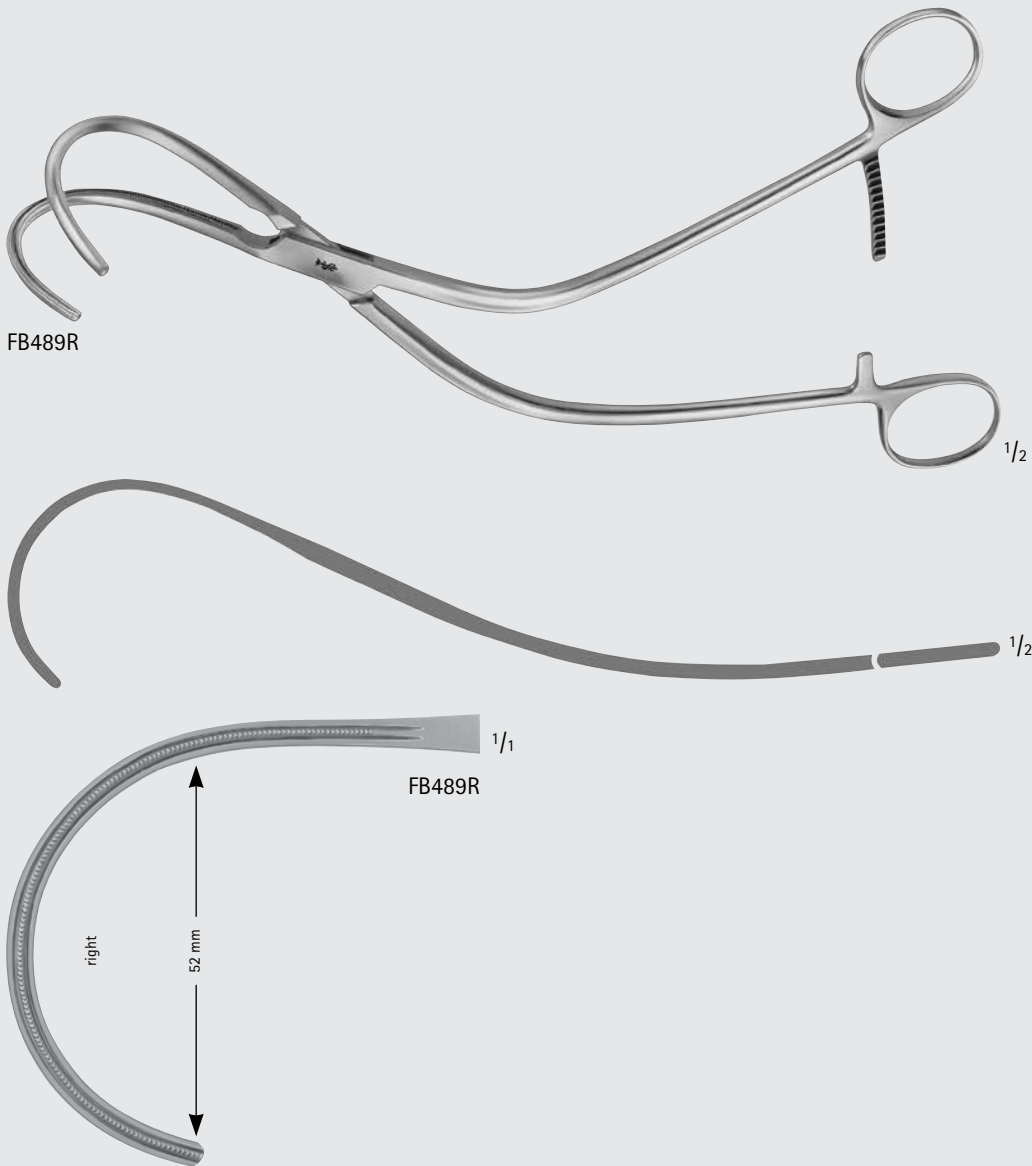

Cardiovascular

Vascular Clamps

LAMBERT-KAY Atraumatic Aortic Clamp

Catalog Number	Weight	Jaw Length (mm)	Length (in.)
FB490R	LIGHT	93	8 1/2
FB492R	HEAVY	100	8 1/4

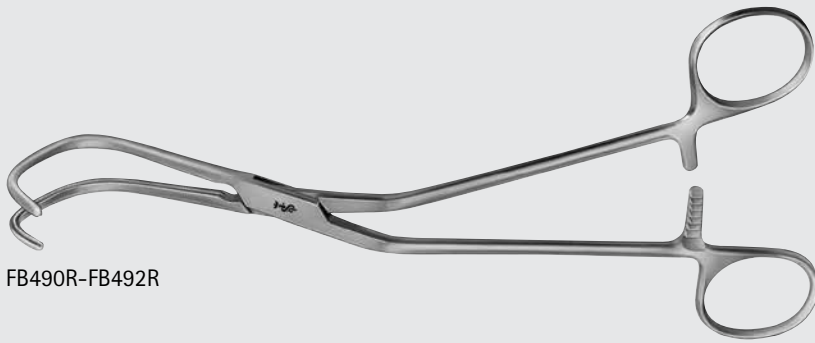

FB490R-FB492R

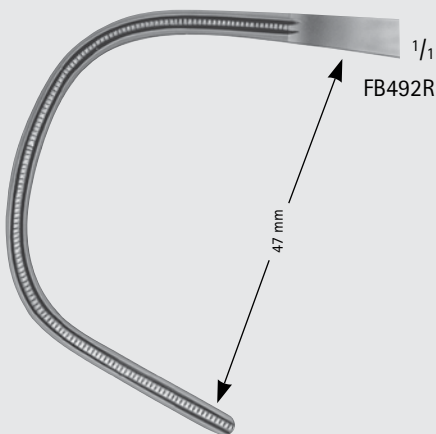
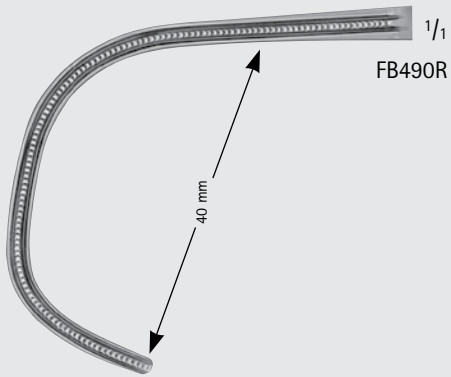

INCHES

Cardiovascular

Vascular Clamps

DEBAKEY-LAMBERT Atraumatic Aortic Clamp

Catalog Number	Jaw Angle	Jaw Length (mm)	Length (in.)
FB491R	MULTI	40	10

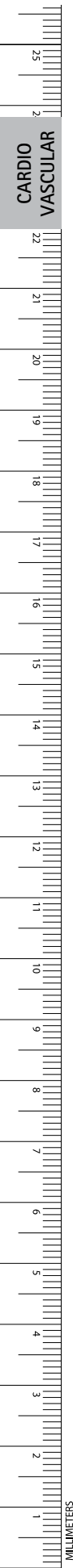
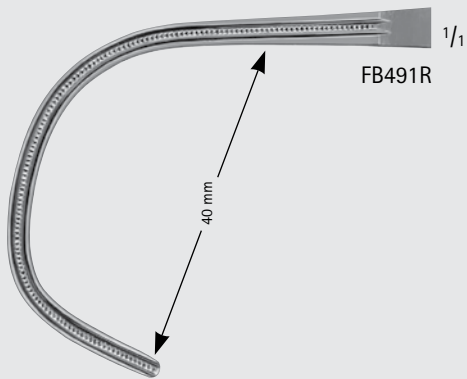

Cardiovascular

Vascular Clamps

MORRIS Atraumatic Aortic Cross Clamp

Catalog Number	Jaw Angle	Jaw Length (mm)	Length (in.)
FB493R	70°	67	6 7/8

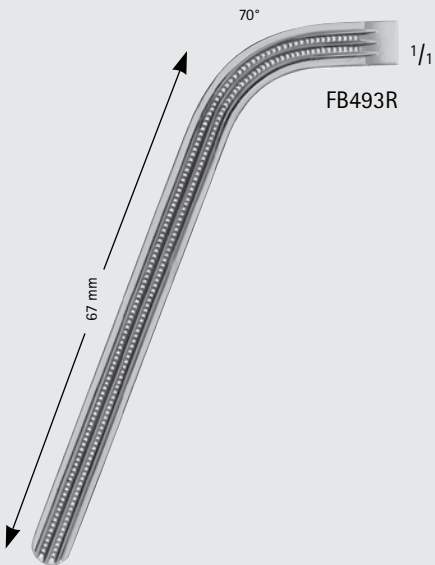
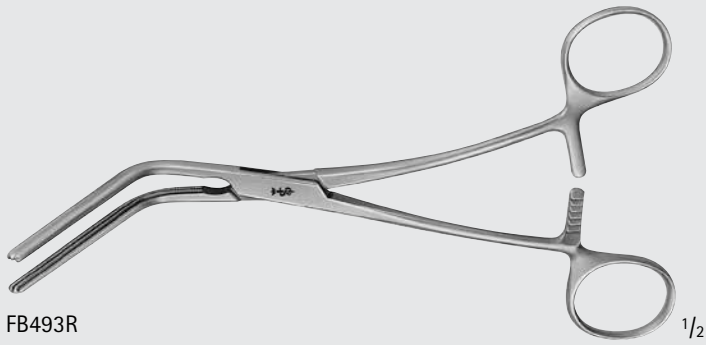

INCHES

Cardiovascular

Vascular Clamps



CARDIO
VASCULAR

DEBAKEY-MORRIS Atraumatic Cross-Clamp

Catalog Number	Jaw Angle	Jaw Length (mm)	Length (in.)
FB494R	70°	70	9 1/2

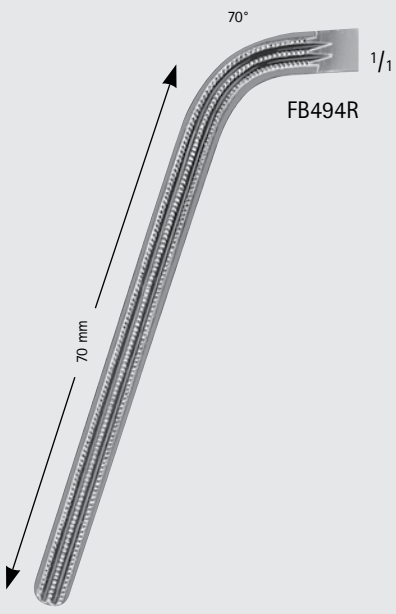
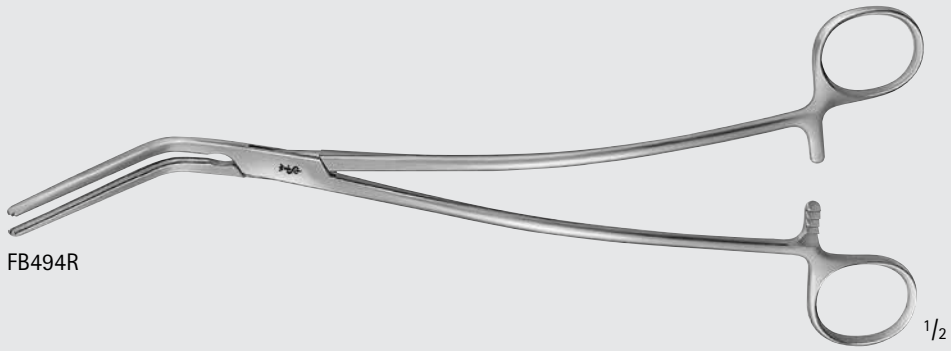

Cardiovascular

Vascular Clamps

OCHSNER Atraumatic Aortic Clamp

Catalog Number	Jaw Angle	Jaw Length (mm)	Length (in.)
FB495R	70°	50	10 1/4

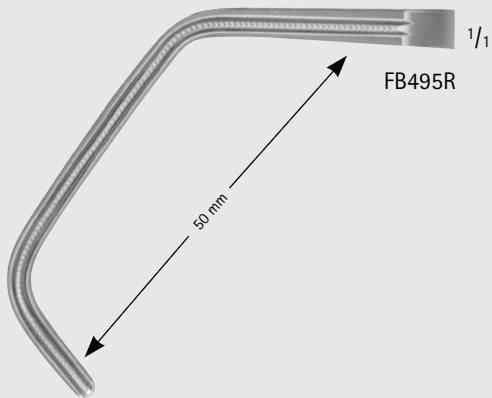
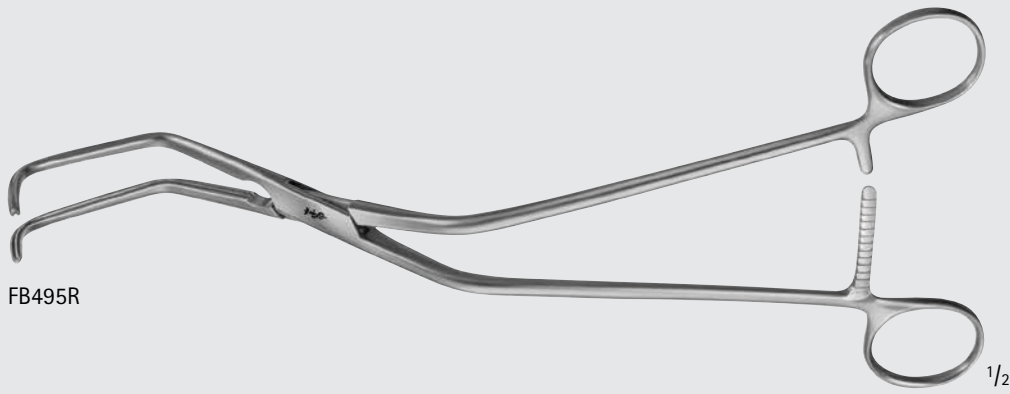

Cardiovascular

Vascular Clamps

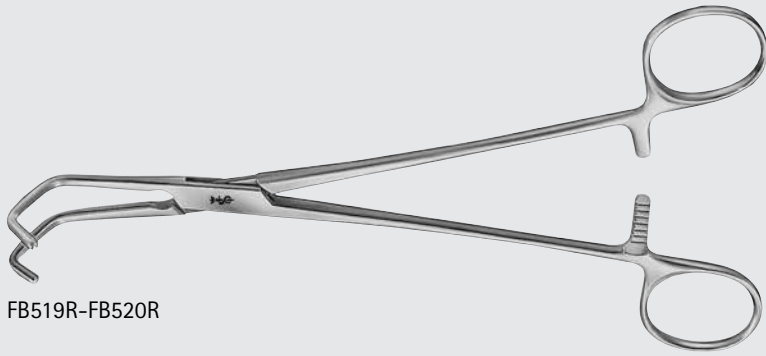
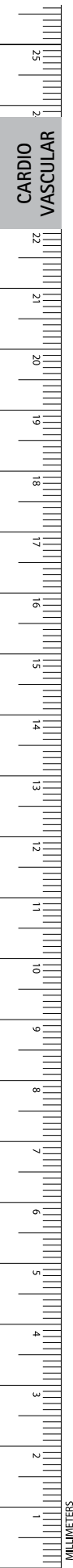

FB519R-FB520R

DEBAKEY-BECK Atraumatic Vena Cava Clamp

Catalog Number	Jaw Length (mm)	Length (in.)
FB519R	30	8
FB520R	45	8 1/4

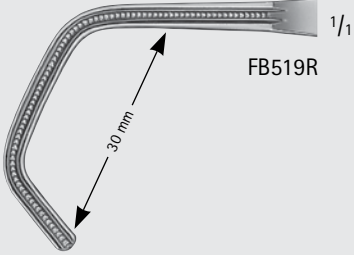

FB519R

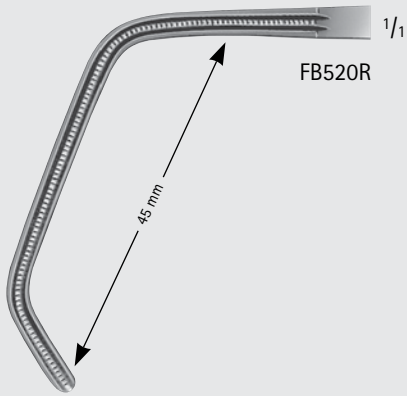

FB520R

Cardiovascular Vascular Clamps

DEBAKEY Atraumatic Tangential Clamp

Catalog Number	Jaw Size (#)	Jaw Length (mm)	Length (in.)
FB500R	1	38	8 3/4
FB501R	2	48	10 1/2
FB502R	3	54	10 5/8
FB503R	4	58	10 5/8
FB504R	5	75	11

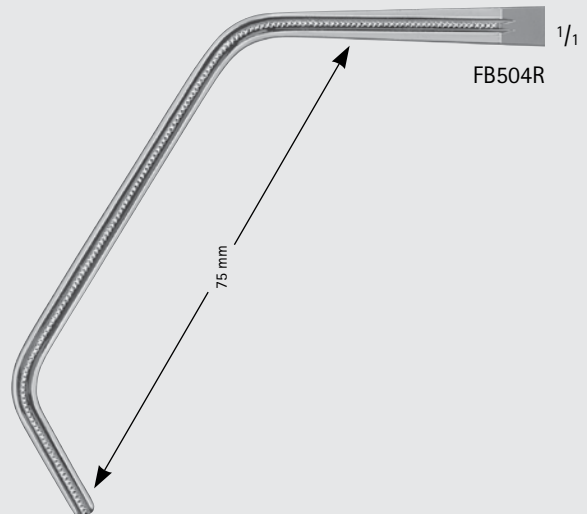
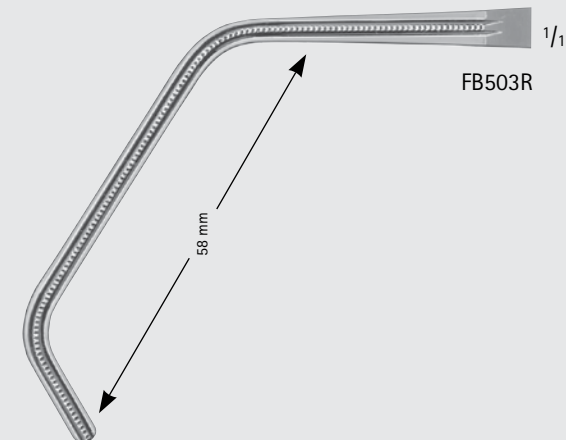
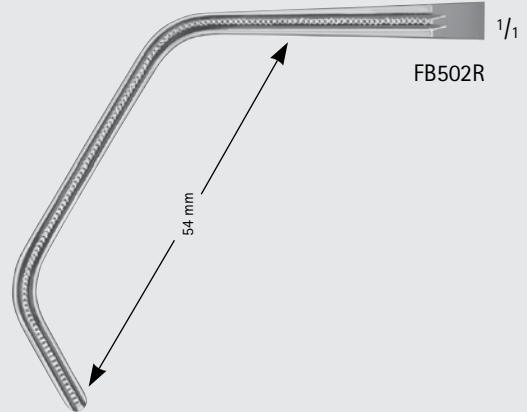
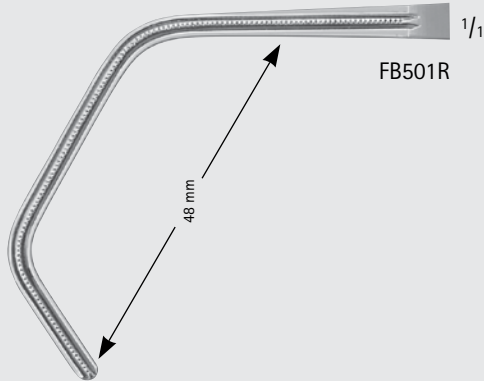
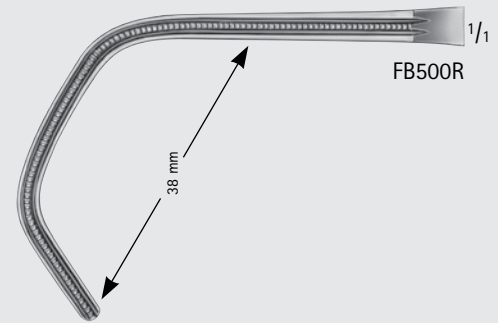
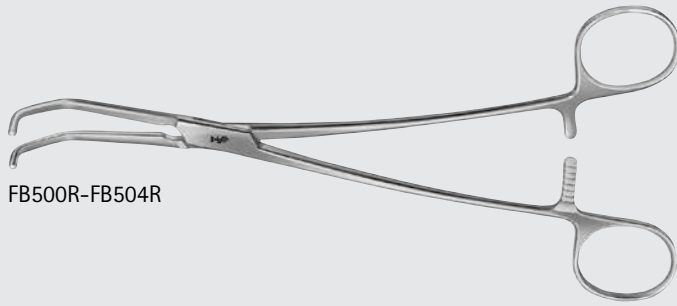

INCHES

Cardiovascular

Vascular Clamps



CARDIO
VASCULAR

DEBAKEY-SATINSKY Atraumatic Tangential Clamp

Catalog Number	Jaw Length (mm)	Length (in.)
FB506R	32	9 1/4
FB507R	40	9 1/2
FB508R	47	9 5/8

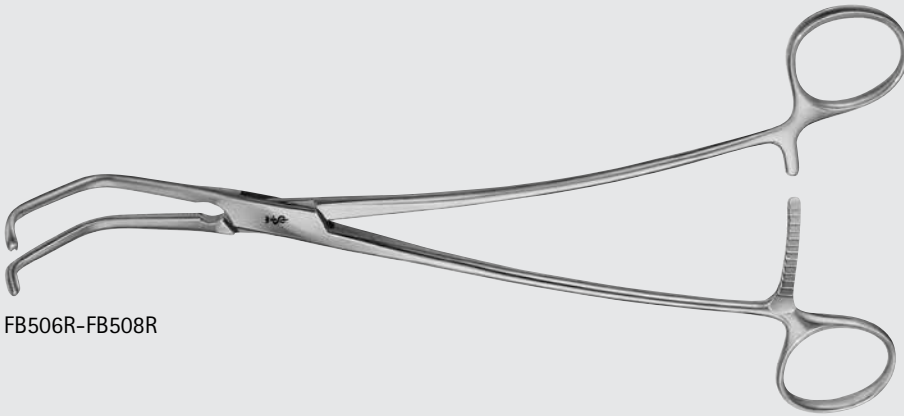

FB506R-FB508R

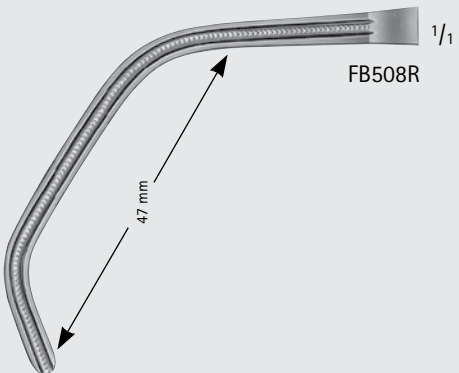
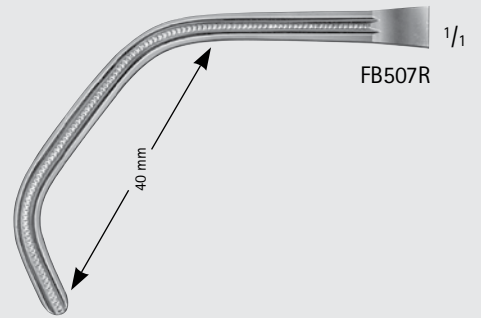
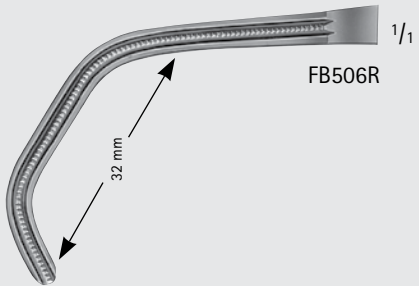

Cardiovascular
Vascular Clamps

DEBAKEY Atraumatic Sidewinder
Aortic Clamp

Catalog Number	Jaw Angle	Jaw Length (mm)	Length (in.)
FB576R	70°	60	10 1/2



FB576R

1/2

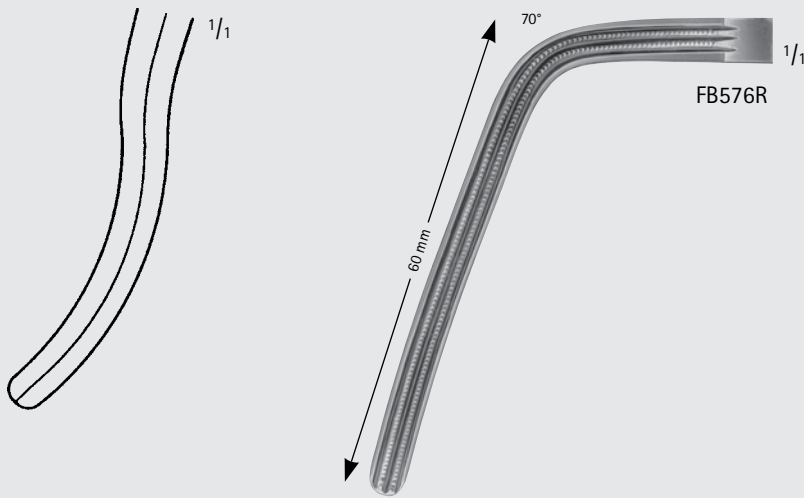

FB576R

1/1

1/1

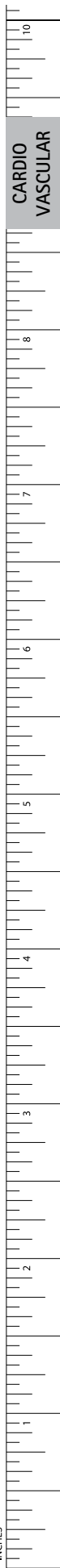

Cardiovascular

Vascular Clamps

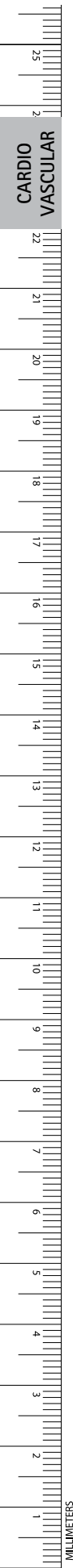

CARDIO
VASCULAR

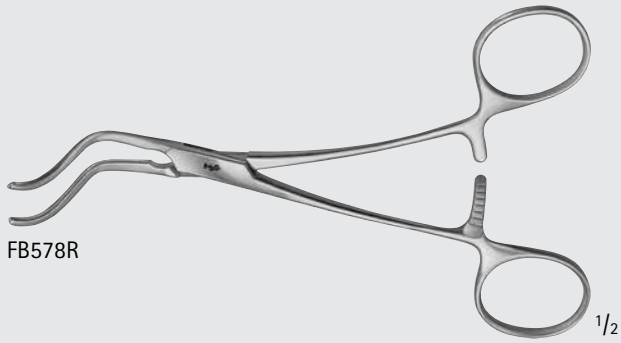

FB578R

1/2



1/2

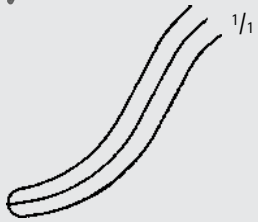

1/1

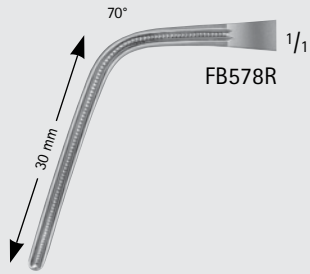

70°

30 mm

FB578R

1/1

DEBAKEY-SUBRAMANIAN Atraumatic Aortic Clamp

Catalog Number	Jaw Angle	Jaw Length (mm)	Length (in.)
FB578R	70°	30	6 1/8

Cardiovascular

Vascular Clamps

DEBAKEY Vascular Clamp

Catalog Number	Jaw Angle	Jaw Length (mm)	Length (in.)
US123	60°	40	4 1/4
US124	90°	40	3 3/4

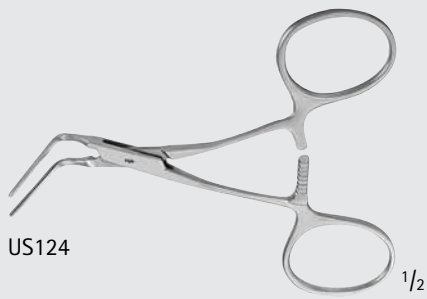
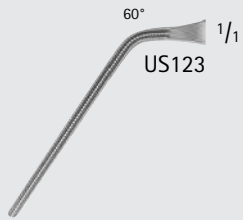
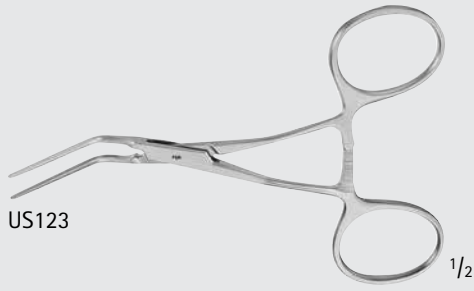

DEBAKEY Partial Occlusion Clamp

Catalog Number	Jaw Angle	Jaw Length (mm)	Length (in.)
US125	MULTI	24	4 1/2

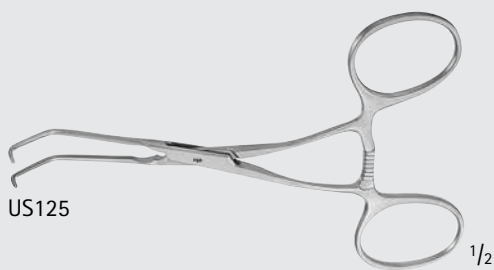

Cardiovascular

Vascular Clamps

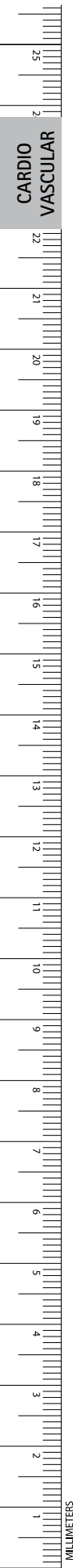

COOLEY Atraumatic Ring Handle Bulldog Clamp

Catalog Number	Shaft Angle	Jaw Angle	Jaw Length (mm)	Length (in.)
FB700R	STR	STR	50	5
FB702R	STR	CVD	50	4 1/2
FB701R	15° ANG	STR	50	5
FB703R	SLIGHT-CVD	CVD	50	5
FB704R	SLIGHT-CVD	40°	37	4 3/4
FB706R	SLIGHT-CVD	MULTI	52	5
FB705R	CVD	MULTI	50	4 3/4
FB708R	CVD	MULTI	12	4 1/4
FB707R	ANG	90°	41	4



COOLEY-BECK Atraumatic Pediatric
Clamp, Curved

Catalog Number	Jaw Length (mm)	Length (in.)
FB731R	25	6
FB732R	30	6 1/8

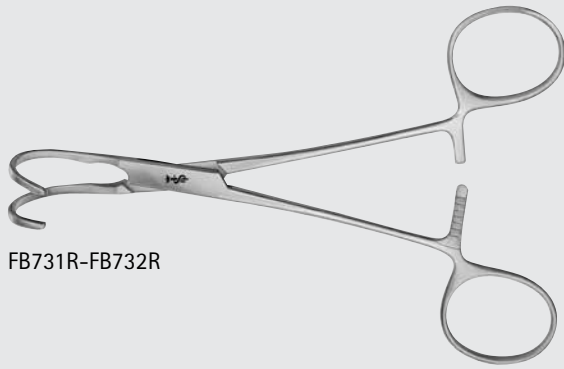

FB731R-FB732R

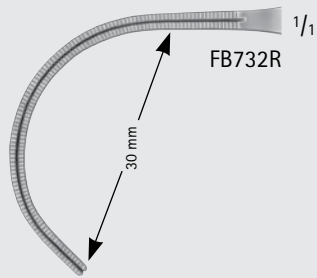
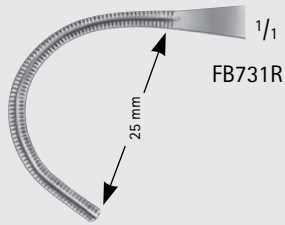

COOLEY Atraumatic Peripheral Vascular
Clamp, Angled

Catalog Number	Jaw Length (mm)	Length (in.)
MB233	65	7

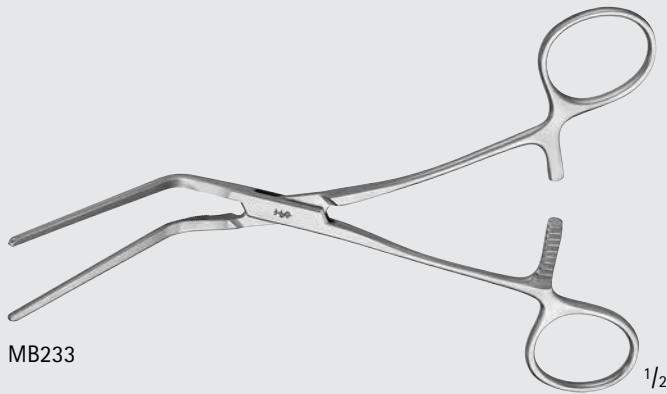

MB233



Cardiovascular

Vascular Clamps

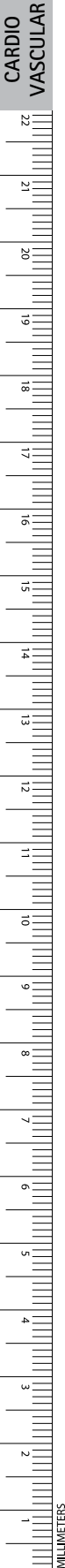

CARDIO
VASCULAR

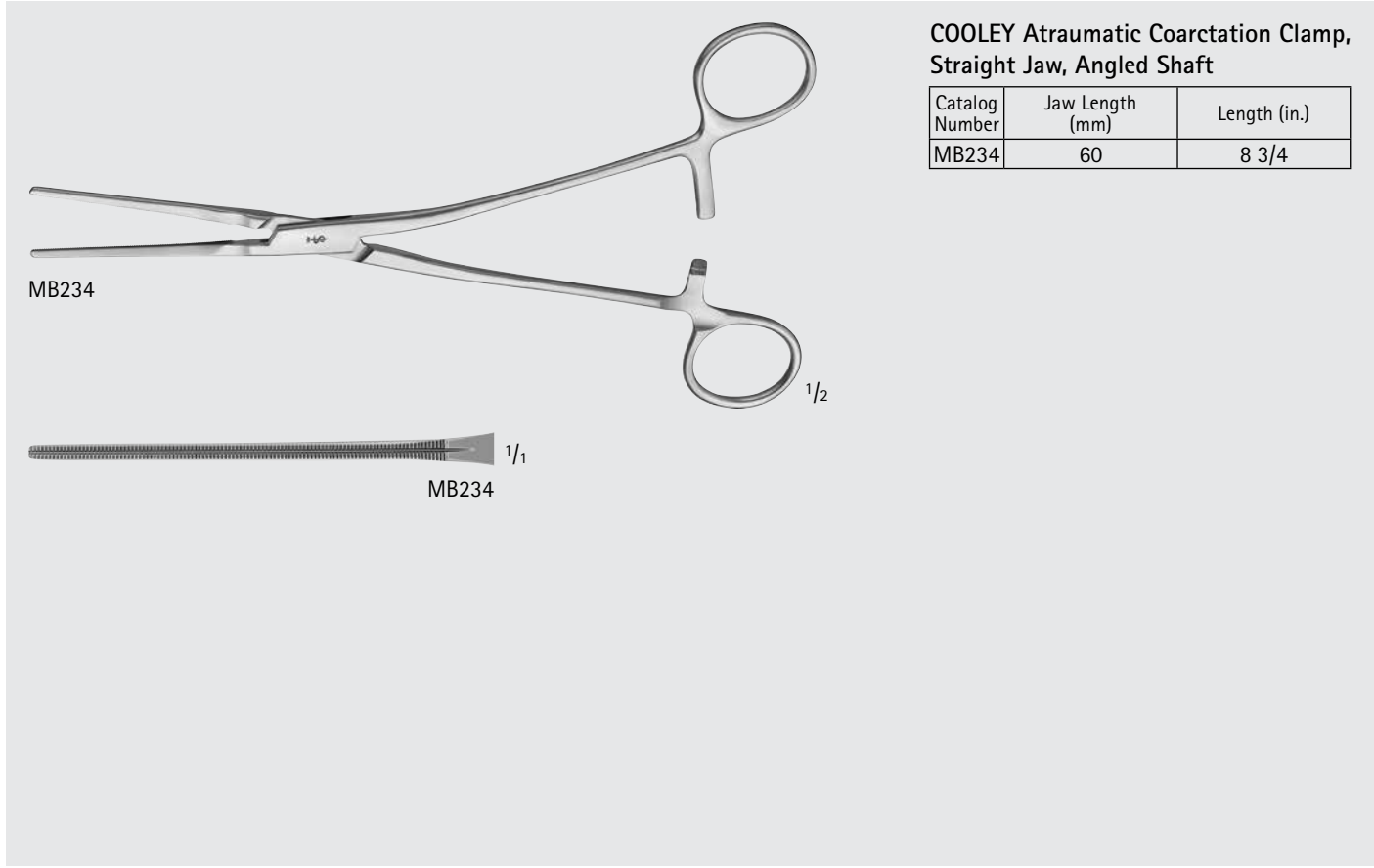

**COOLEY Atraumatic Coarctation Clamp,
Straight Jaw, Angled Shaft**

Catalog Number	Jaw Length (mm)	Length (in.)
MB234	60	8 3/4

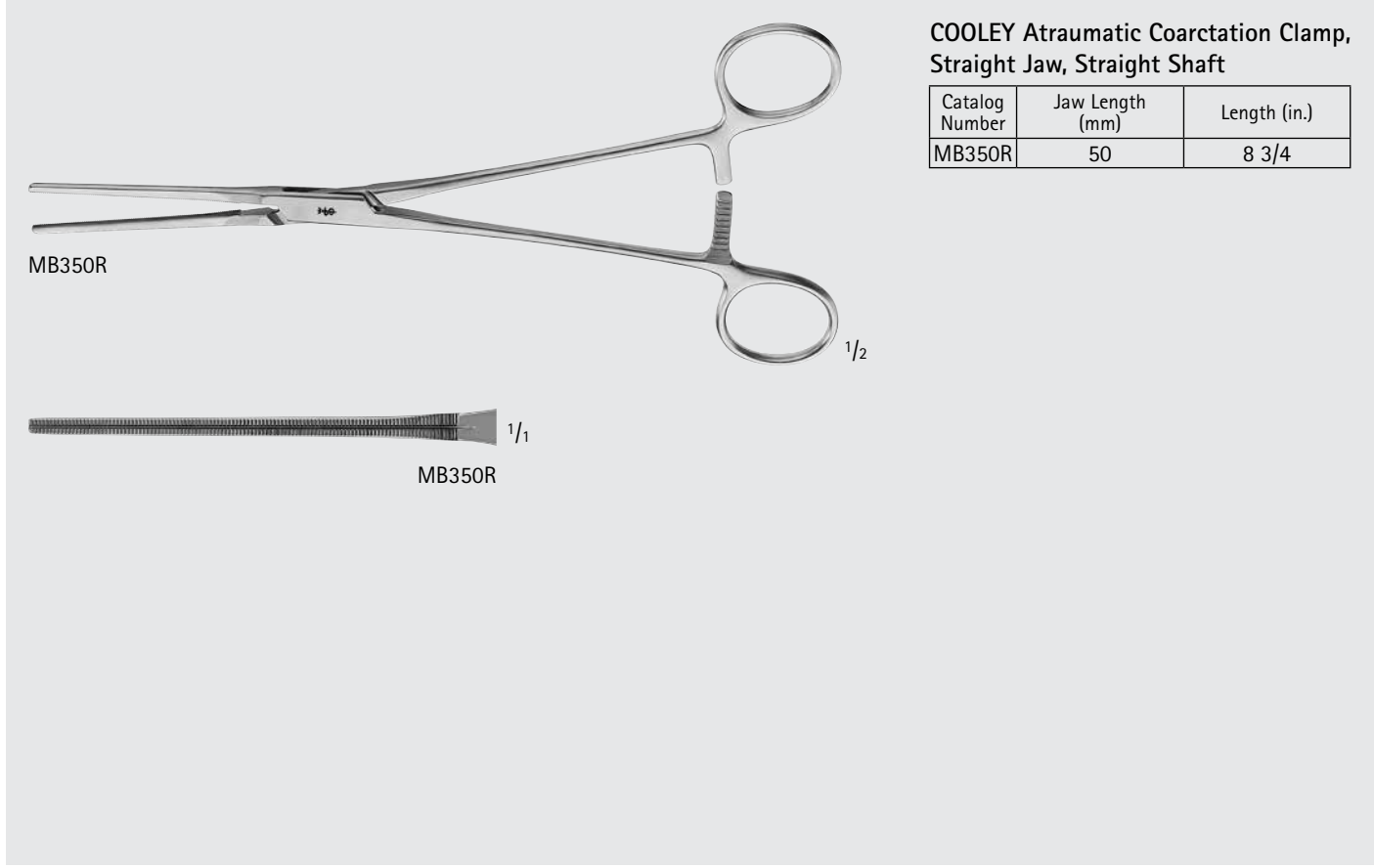

**COOLEY Atraumatic Coarctation Clamp,
Straight Jaw, Straight Shaft**

Catalog Number	Jaw Length (mm)	Length (in.)
MB350R	50	8 3/4



DERRA-COOLEY Atraumatic Clamp

Catalog Number	Jaw Length (mm)	Length (in.)
FB725R	16	6 3/4
FB726R	21	6 7/8
FB727R	27	6 7/8

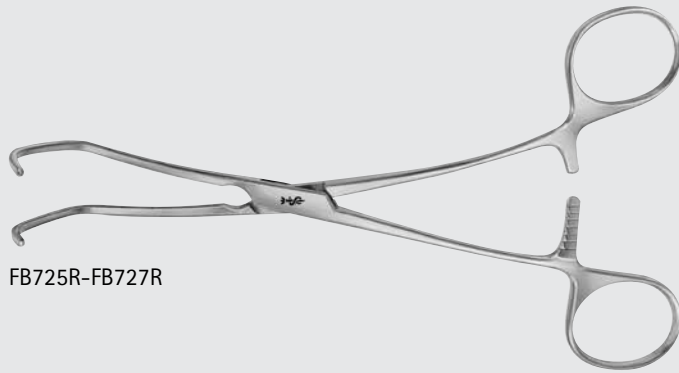

FB725R-FB727R

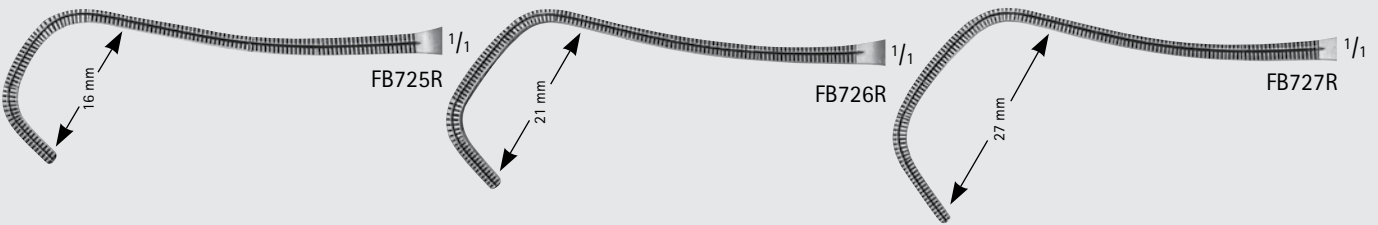

COOLEY Atraumatic Clamp, Spoon Shaped

Catalog Number	Jaw Length (mm)	Length (in.)
FB743R	42	5 3/4

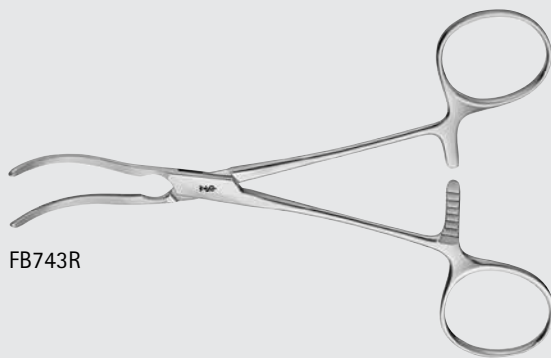

FB743R



FB743R

COOLEY-SATINSKY Atraumatic Pediatric Clamp

Catalog Number	Jaw Length (mm)	Length (in.)
MB613R	21	5 1/2

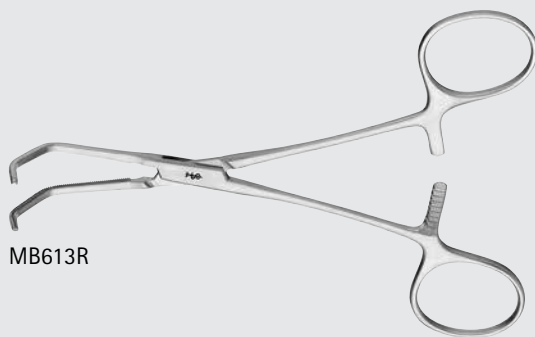

MB613R

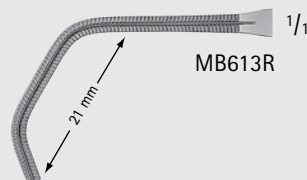

MB613R

Cardiovascular

Vascular Clamps

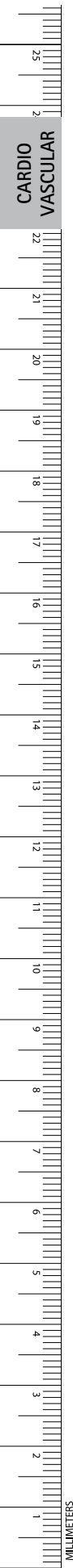

CARDIO
VASCULAR

COOLEY Atraumatic Cardiovascular Clamp, Curved

Catalog Number	Jaw Length (mm)	Length (in.)
MB348R	55	8 1/4

MB348R 1/2

MB348R 1/1

HENDREN Atraumatic Cardiovascular Clamp

Catalog Number	Jaw Length (mm)	Length (in.)
MB743R	13	8 1/4
MB744R	30	8 1/2
MB745R	35	8 1/2
MB746R	40	8 3/4
MB747R	45	8 3/4

MB743R-MB747R

MB743R 1/1 (13 mm jaw, 50 mm length)

MB744R 1/1 (30 mm jaw, 50 mm length)

MB745R 1/1 (35 mm jaw, 55 mm length)

MB746R 1/1 (40 mm jaw, 55 mm length)

MB747R 1/1 (45 mm jaw, 60 mm length)

COOLEY Atraumatic Pediatric
Anastomosis Clamp, Curved

Catalog Number	Jaw Length (mm)	Length (in.)
FB734R	36	6 3/4
FB735R	44	6 3/4

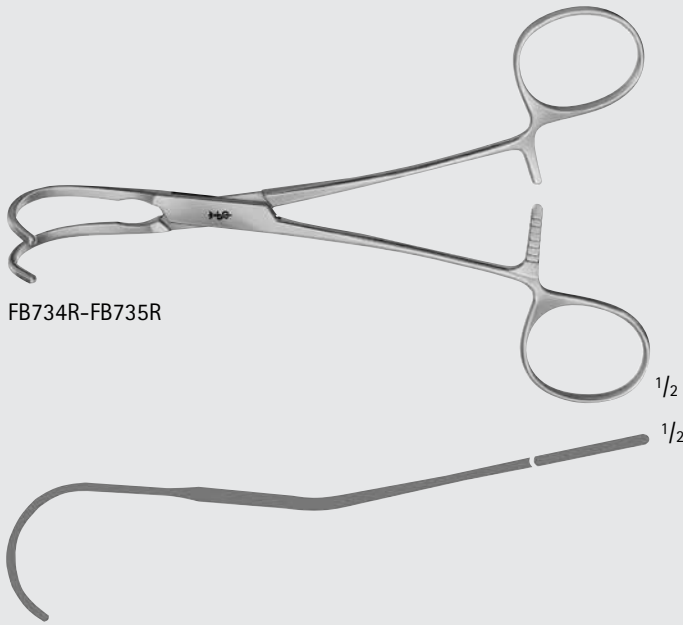

FB734R-FB735R

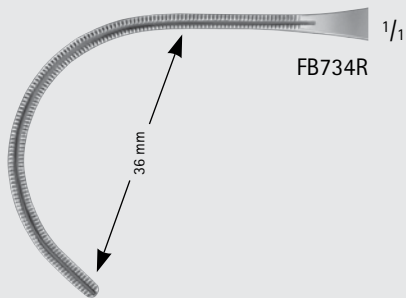

FB734R

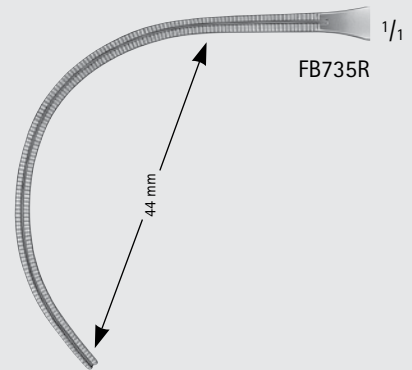

FB735R

POTTS Anastomosis Clamp

Catalog Number	Jaw Angle	Jaw Length (mm)	Length (in.)
MB547R	90°	40	7 1/4

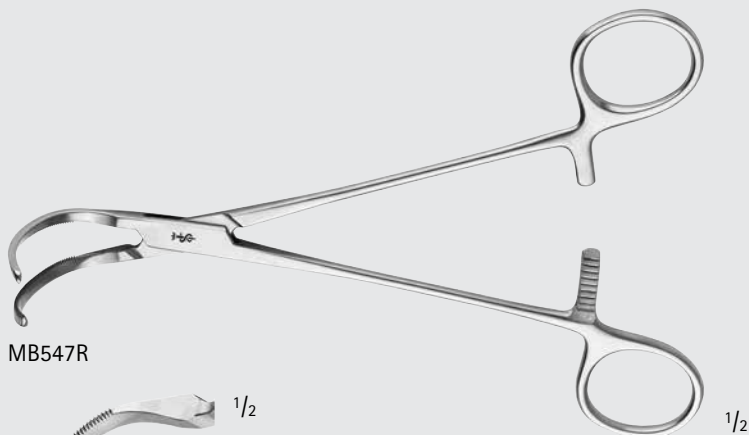

MB547R

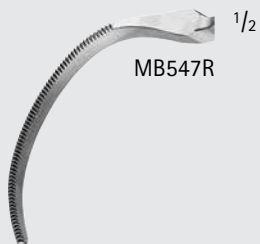

MB547R

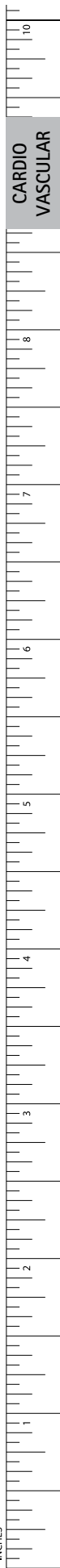

INCHES

Cardiovascular

Vascular Clamps

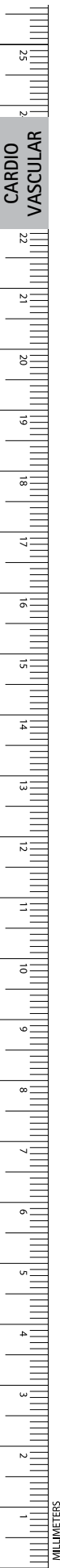

CARDIO
VASCULAR

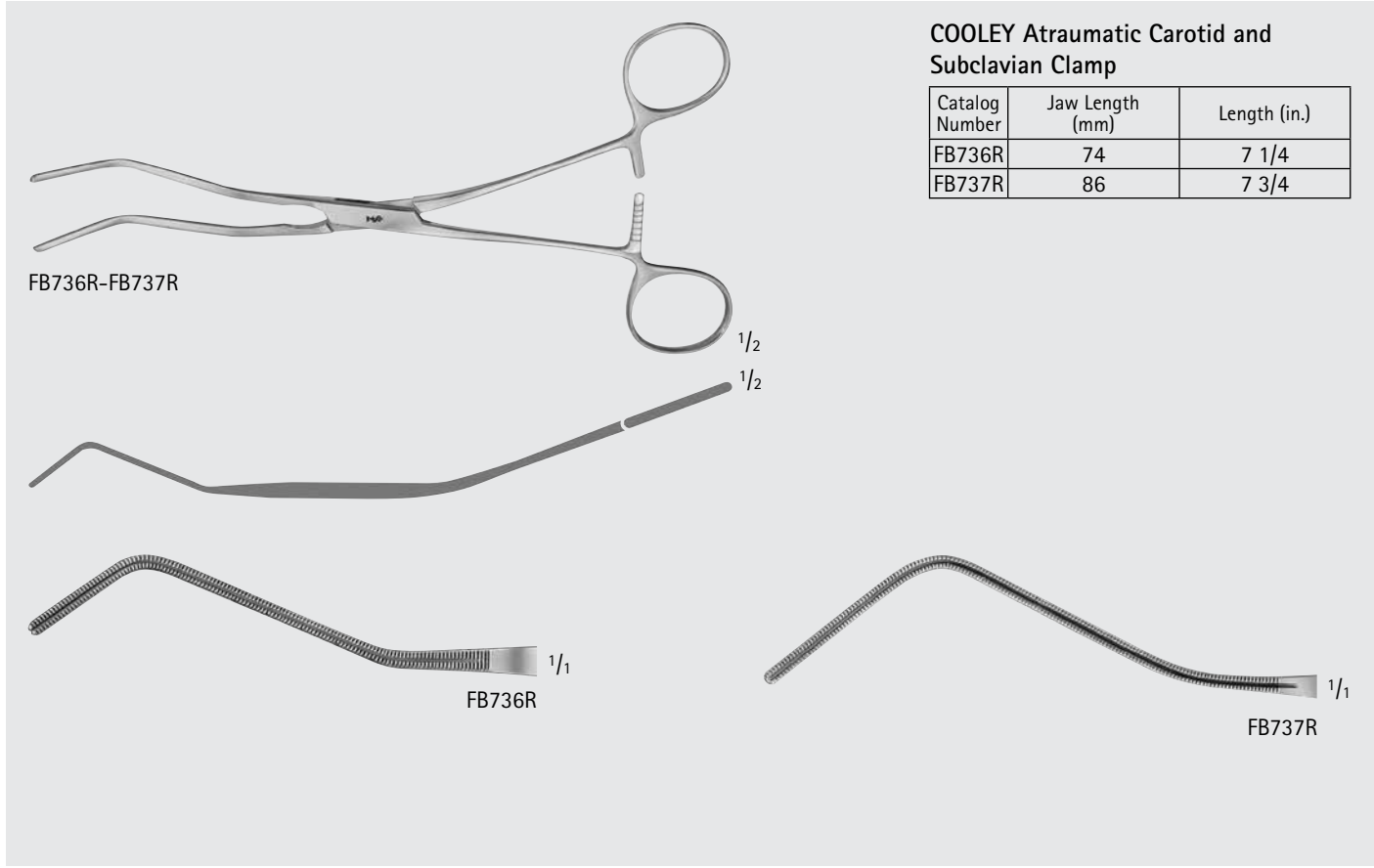

COOLEY Atraumatic Carotid and Subclavian Clamp

Catalog Number	Jaw Length (mm)	Length (in.)
FB736R	74	7 1/4
FB737R	86	7 3/4

FB736R-FB737R

1/2

1/2

FB736R

1/1

FB737R

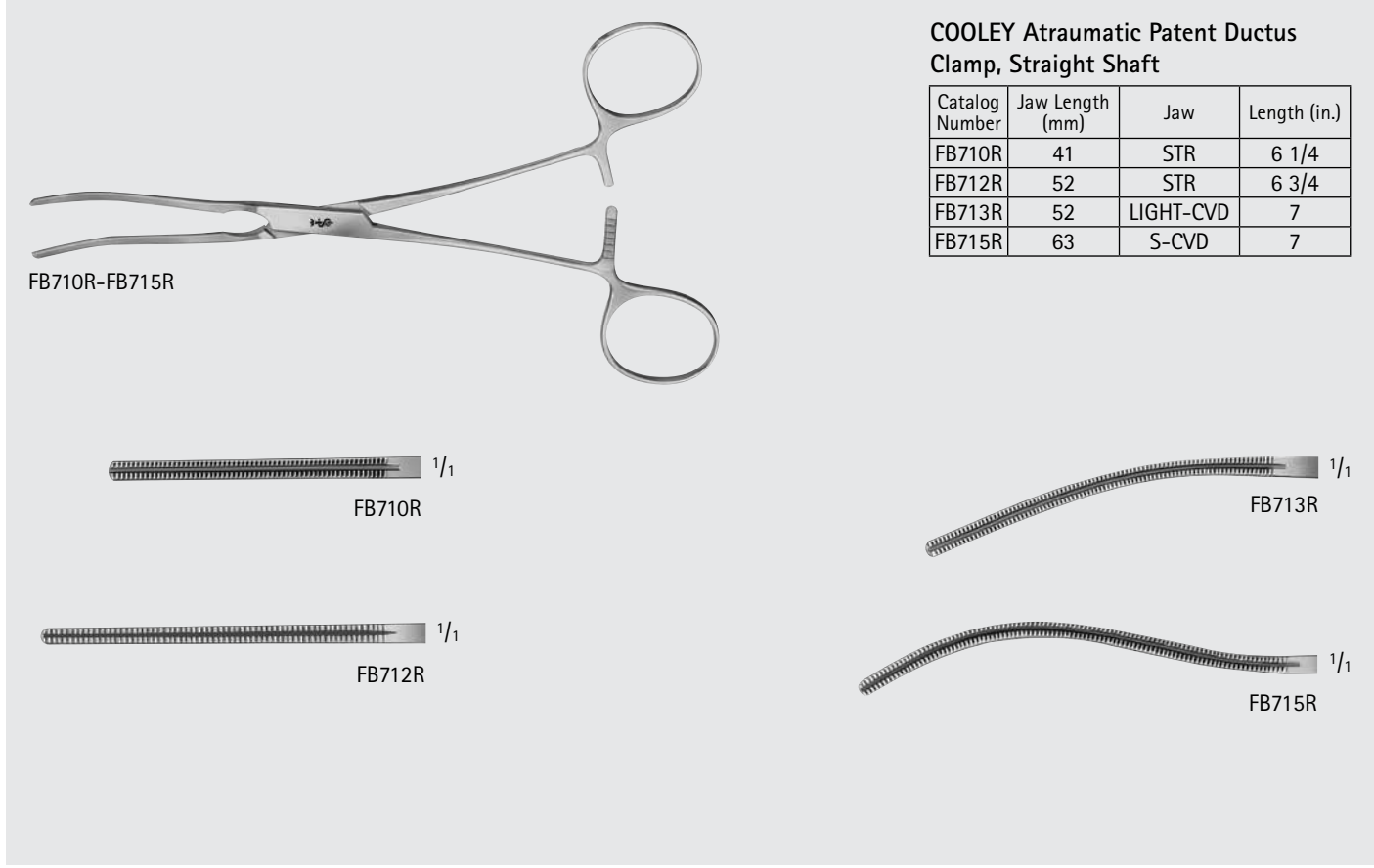

COOLEY Atraumatic Patent Ductus Clamp, Straight Shaft

Catalog Number	Jaw Length (mm)	Jaw	Length (in.)
FB710R	41	STR	6 1/4
FB712R	52	STR	6 3/4
FB713R	52	LIGHT-CVD	7
FB715R	63	S-CVD	7

FB710R-FB715R

1/1

FB710R

1/1

FB712R

1/1

FB713R

1/1

FB715R

Cardiovascular

Vascular Clamps

CARDIO
VASCULAR



COOLEY Atraumatic Patent Ductus Clamp, Angled Shaft

Catalog Number	Jaw Angle	Jaw Length (mm)	Length (in.)
FB711R	STR	41	6 1/4
FB714R	STR	52	6 3/4
FB754R	60°	57	6 1/2
FB755R	60°	67	6 3/4
FB756R	60°	82	7 1/4

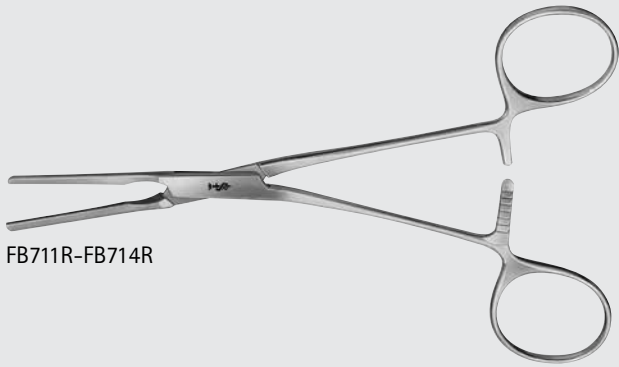

FB711R-FB714R



FB754R-FB756R

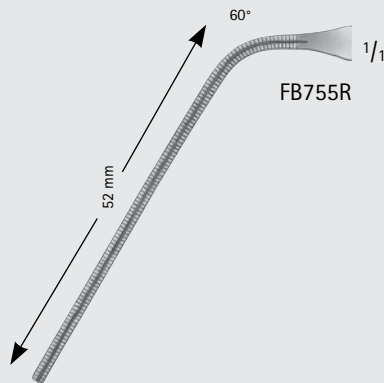
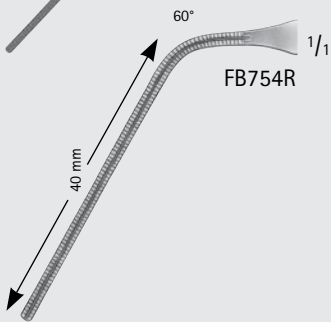
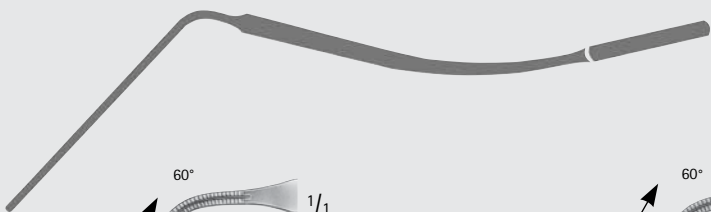

INCHES

Cardiovascular

Vascular Clamps



CARDIO
VASCULAR

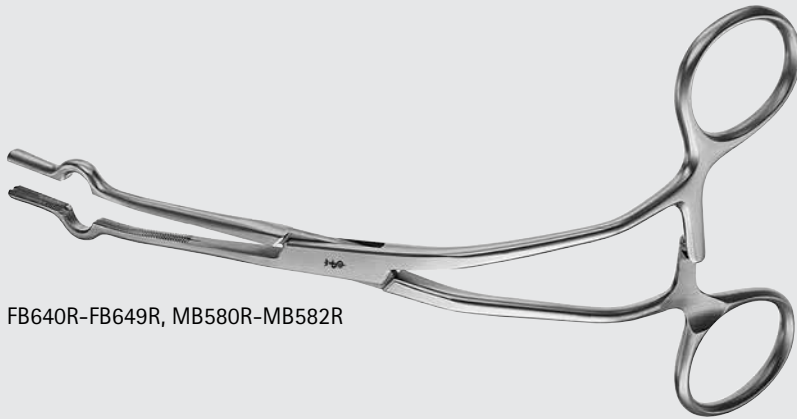

FB640R-FB649R, MB580R-MB582R

COOLEY Cava Occlusion Clamp

Catalog Number	Jaw Size (FR)	Length (in.)
FB640R	20	6 1/4
FB641R	24	6 1/4
FB642R	26	7 1/2
MB580R	28	7 1/2
FB644R	30	7 1/2
MB581R	32	7 1/2
MB582R	34	7 1/2
FB647R	36	7 1/2
FB649R	40	7 1/2



FB640R



FB642R



FB644R



MB582R



FB649R



FB641R



MB580R



MB581R



FB647R

COOLEY Atraumatic Pediatric
Anastomosis Clamp, Angled Shaft

Catalog Number	Jaw Length (mm)	Length (in.)
FB729R	17	6 3/4
FB721R	25	6 1/2
FB722R	28	6 1/2
FB723R	33	6 7/8
FB724R	36	7

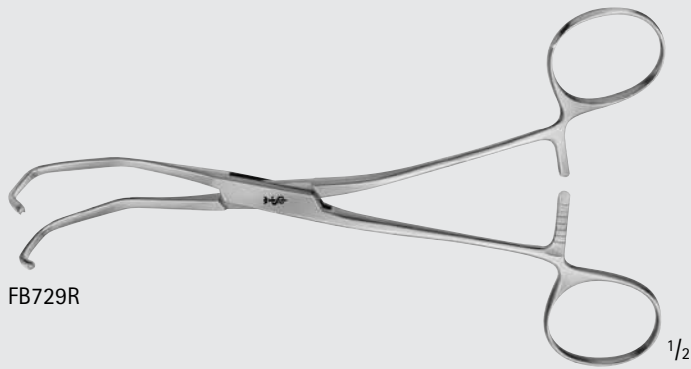

FB729R

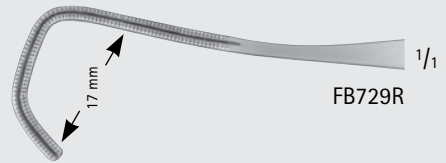

FB729R

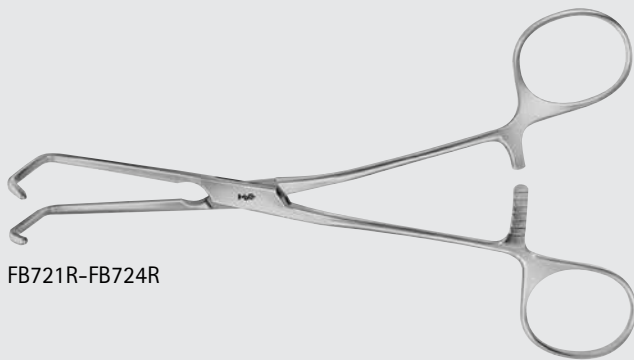

FB721R-FB724R

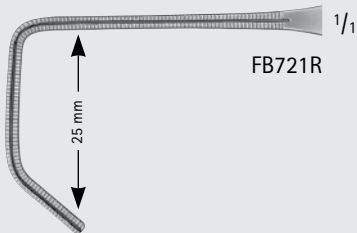

FB721R

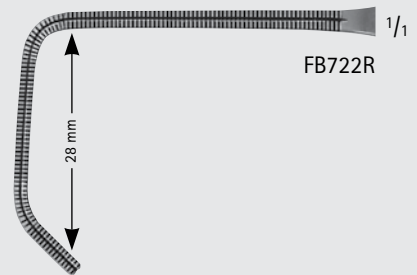

FB722R

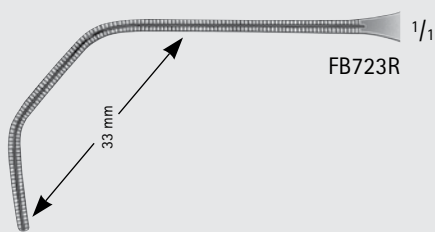

FB723R

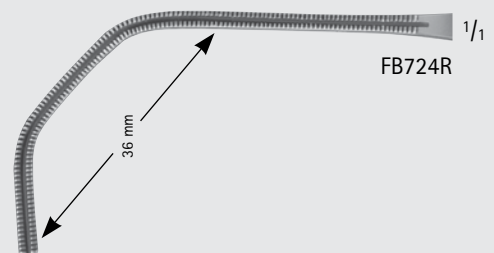

FB724R



Cardiovascular

Vascular Clamps



CARDIO
VASCULAR

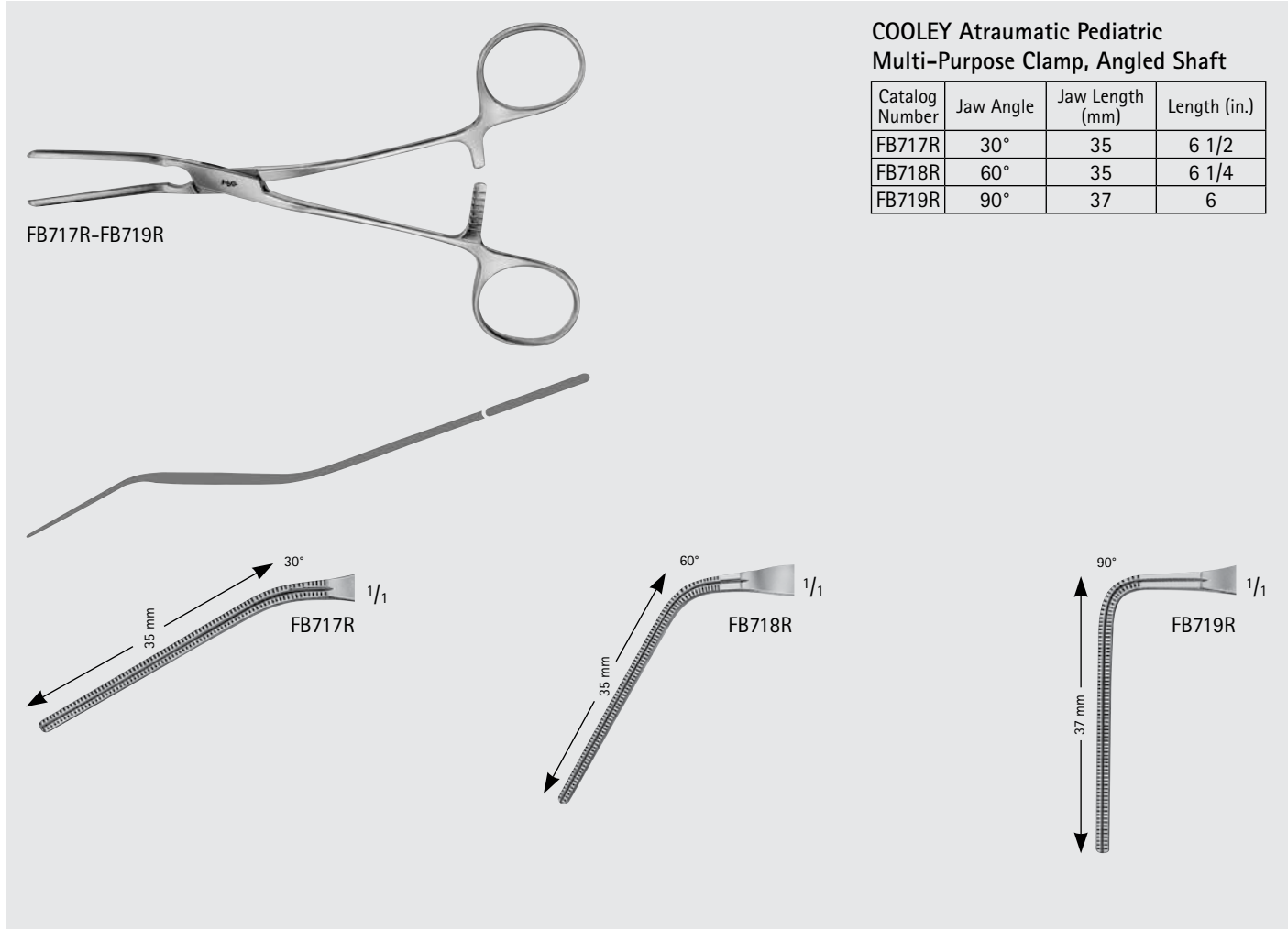

COOLEY Atraumatic Pediatric Multi-Purpose Clamp, Angled Shaft

Catalog Number	Jaw Angle	Jaw Length (mm)	Length (in.)
FB717R	30°	35	6 1/2
FB718R	60°	35	6 1/4
FB719R	90°	37	6

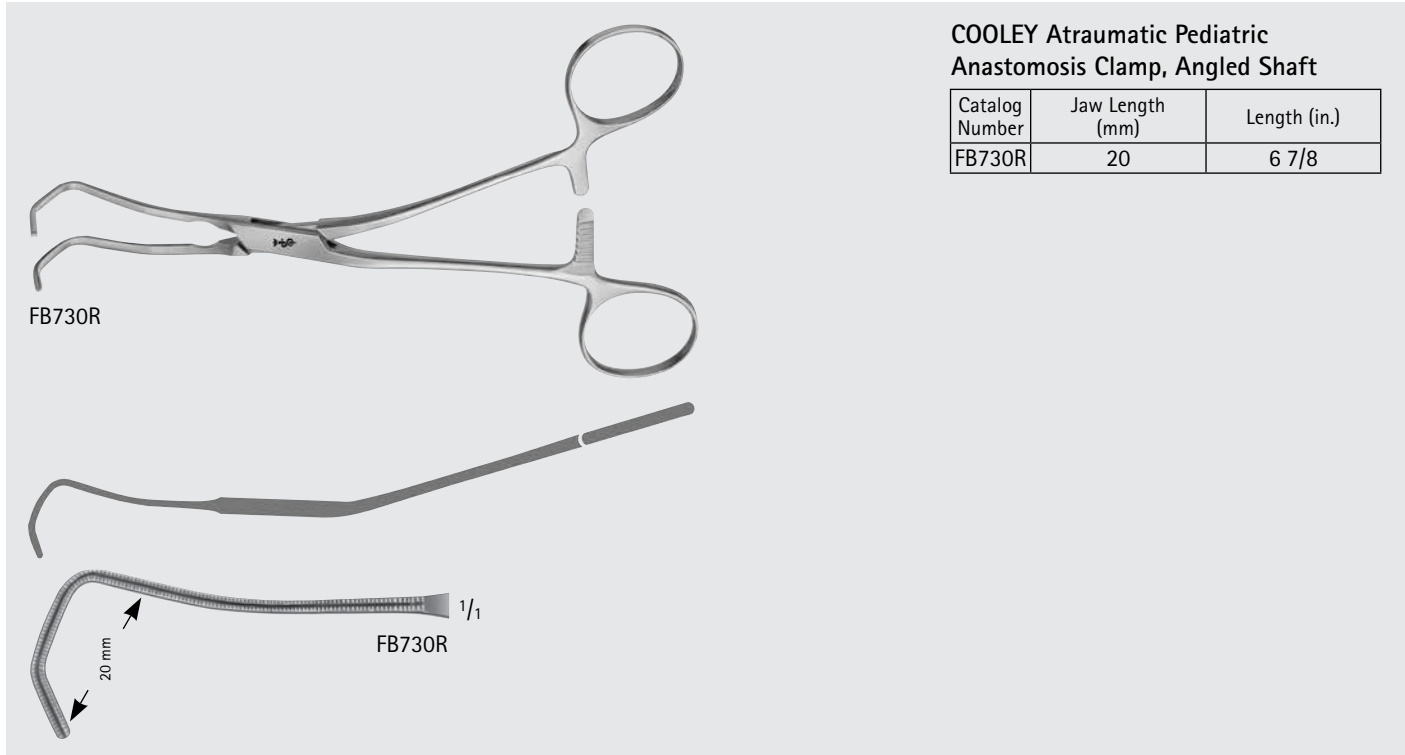

COOLEY Atraumatic Pediatric Anastomosis Clamp, Angled Shaft

Catalog Number	Jaw Length (mm)	Length (in.)
FB730R	20	6 7/8

Cardiovascular

Vascular Clamps

COOLEY Atraumatic Renal Artery Clamp, Angled Shaft

Catalog Number	Jaw Length (mm)	Length (in.)
FB738R	108	10 1/4

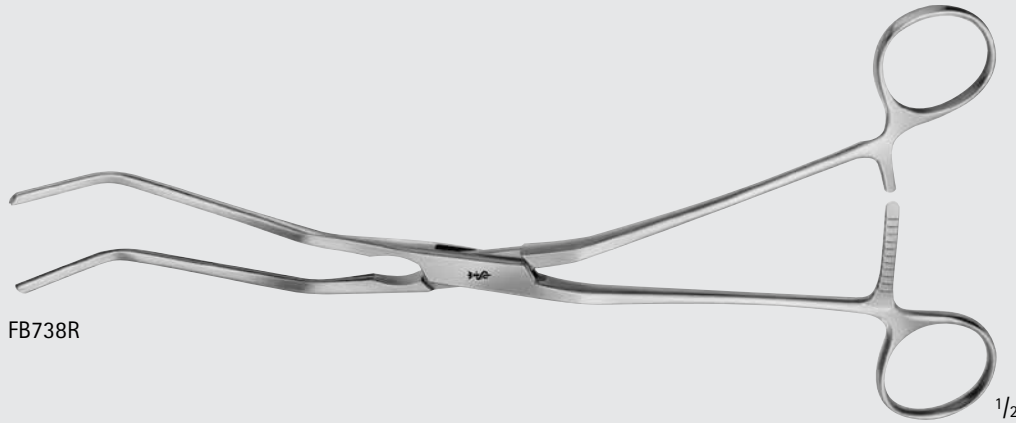

FB738R

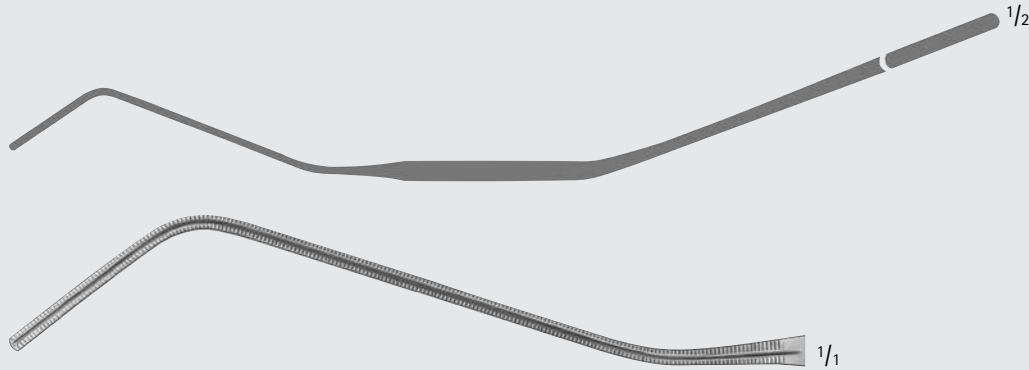

FB738R



Cardiovascular

Vascular Clamps



CARDIO
VASCULAR

**COOLEY Atraumatic Aorta Clamp,
Angled Shaft**

Catalog Number	Jaw Length (mm)	Length (in.)
MB349R	73	10

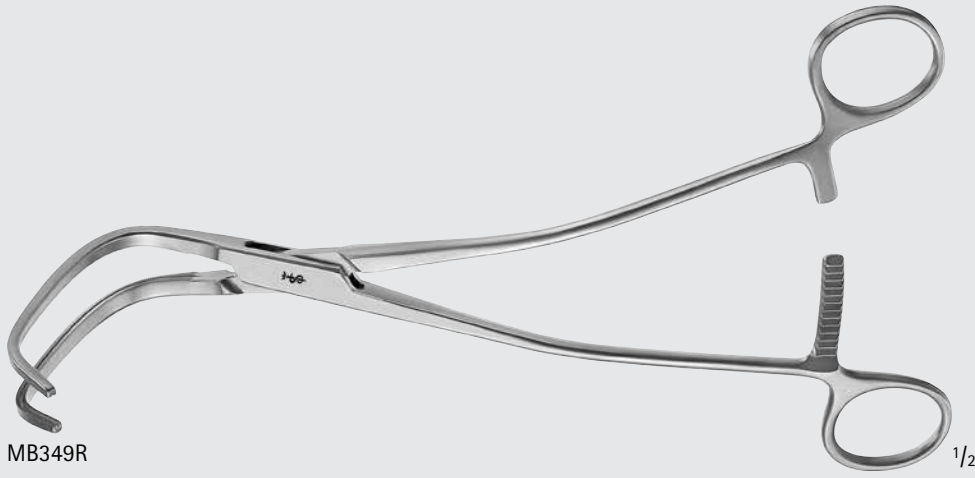

MB349R

1/2

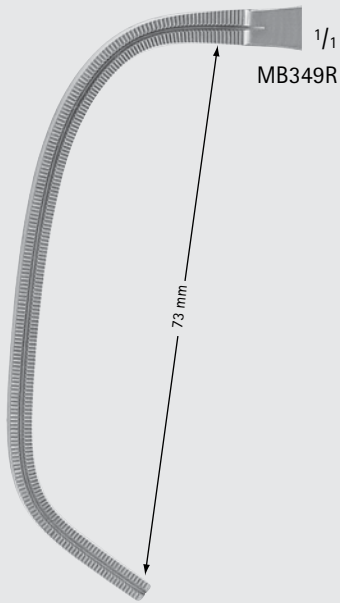

MB349R

73 mm

1/1

Cardiovascular

Vascular Clamps

COOLEY Tangential Clamp, Calibrated

Catalog Number	Jaw (mm)	Length (in.)
MG456R	20 x 7	7 3/4
MG457R	25 x 8	7 7/8
MG458R	38 x 10	7 7/8

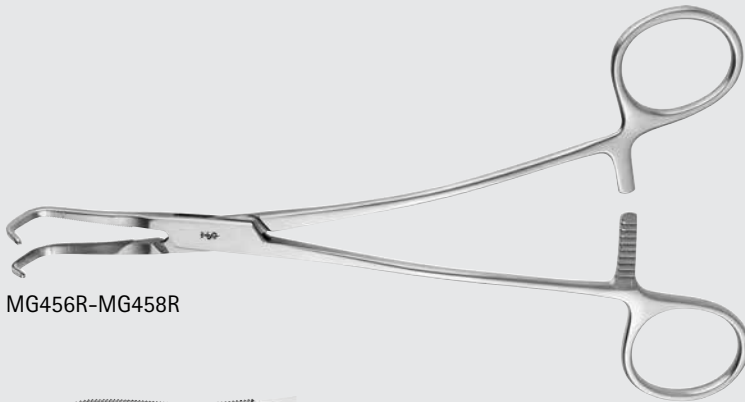

MG456R-MG458R



MG456R



MG457R



MG458R

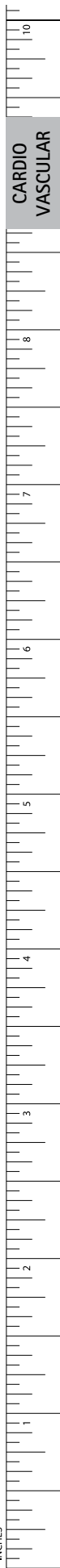

Cardiovascular

Vascular Clamps

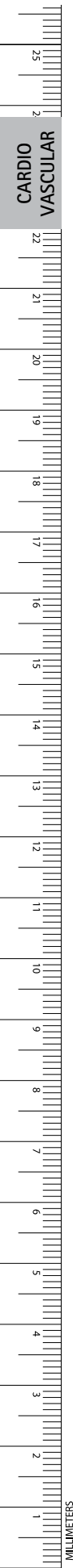

COOLEY Atraumatic Forceps, S-Shaped

Catalog Number	Jaw Length (mm)	Length (in.)
FB764R	115	12 1/2

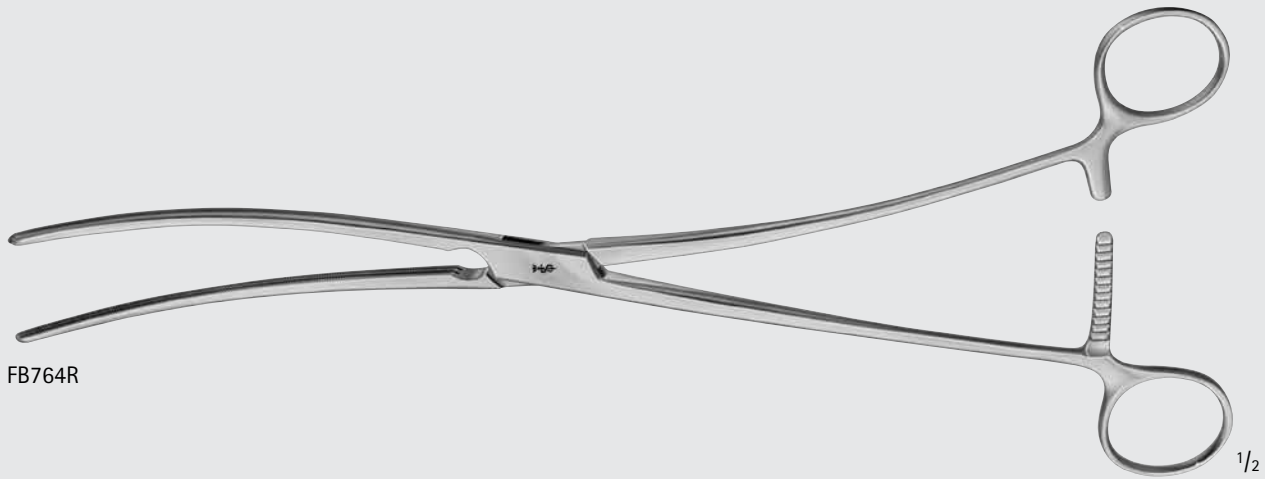

FB764R

1/2



1/2

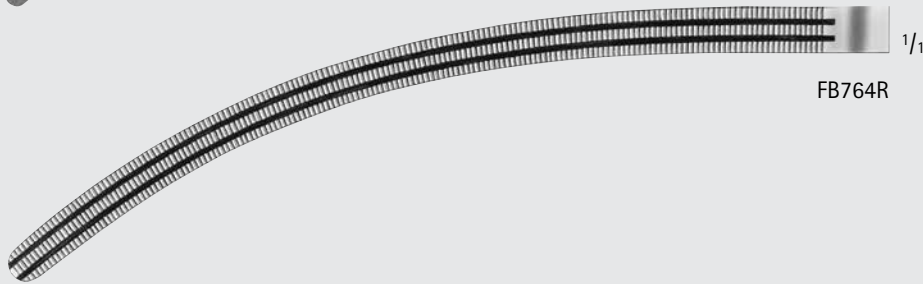

1/1

FB764R

Cardiovascular
Vascular Clamps



COOLEY Atraumatic Multi-Purpose Clamp, Curved, Angled Shaft, Calibrated

Catalog Number	Jaw Length (mm)	Length (in.)
MB528R	32	8

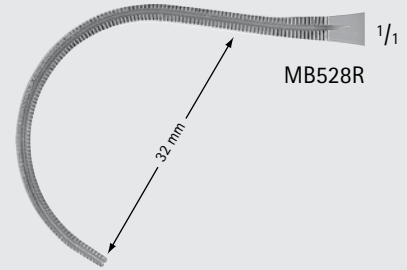
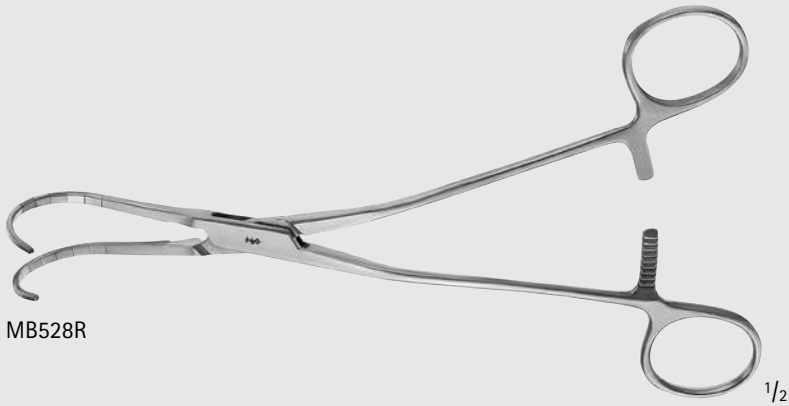

COOLEY Atraumatic Forceps, Curved, Angled Shaft

Catalog Number	Jaw Length (mm)	Length (in.)
FB765R	82	11 1/4

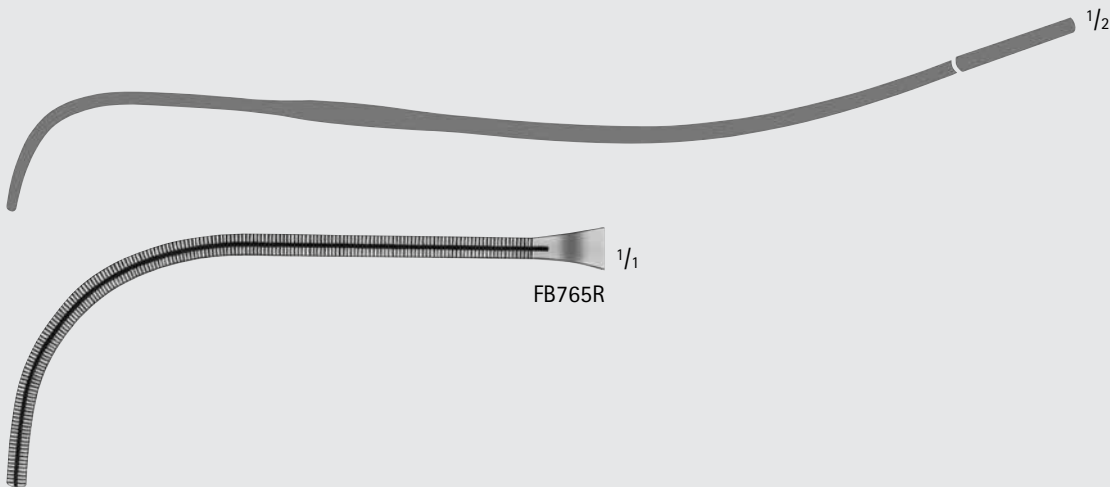
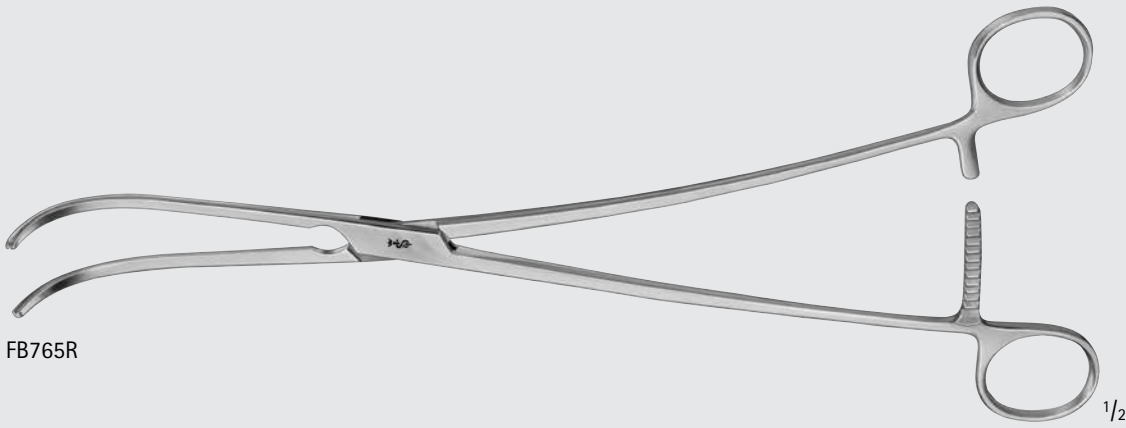

Cardiovascular

Vascular Clamps



PARRY-COOLEY Atraumatic Forceps

Catalog Number	Jaw Length (mm)	Length (in.)
FB775R	70	11 5/8

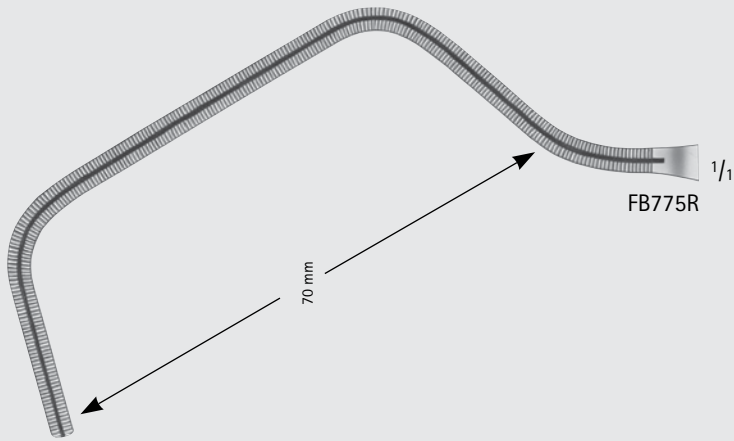
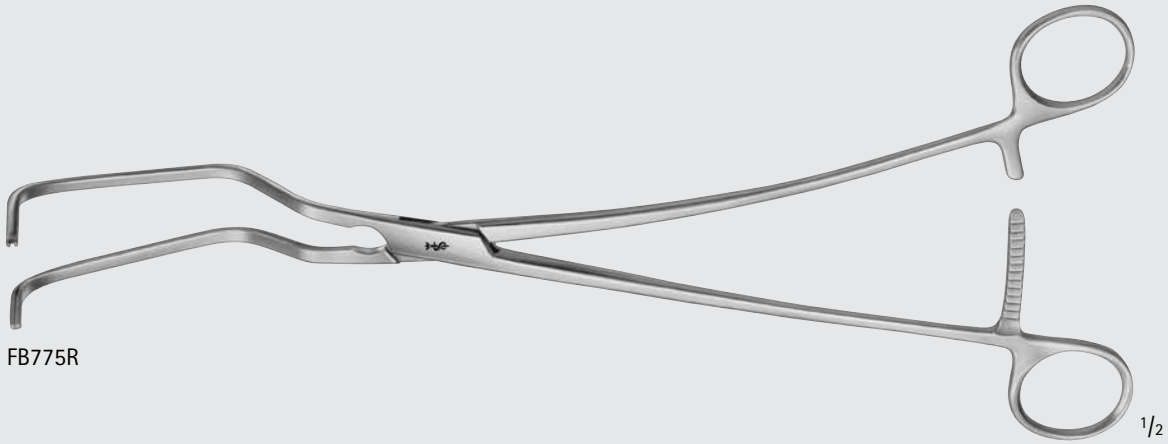

Cardiovascular

Vascular Clamps

COOLEY Auricular Appendage Clamp

Catalog Number	Jaw	Length (in.)
MG451R	40 x 10	10

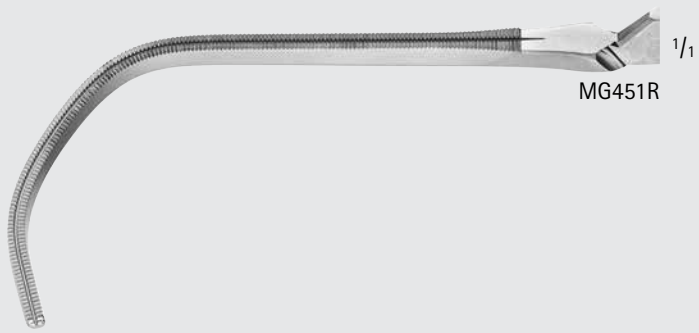
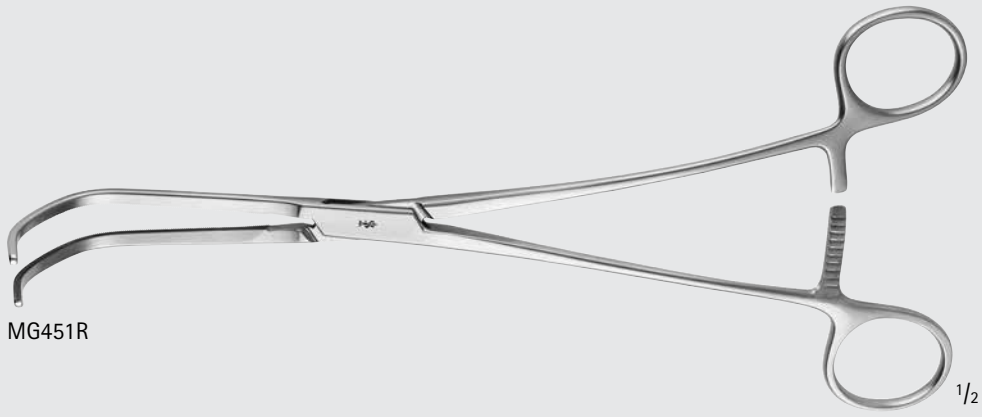

Cardiovascular

Vascular Clamps

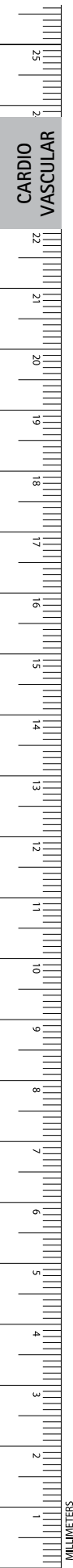

CARDIO
VASCULAR

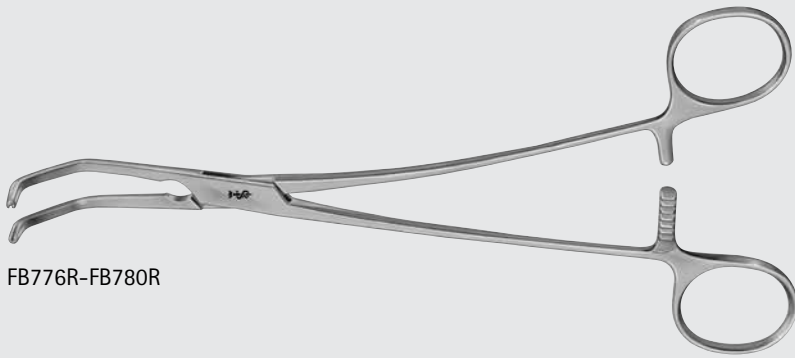

FB776R-FB780R

COOLEY Partial Occlusion Clamp

Catalog Number	Jaw Length (mm)	Length (in.)
FB776R	31	8
FB777R	44	10 1/4
FB778R	50	10 1/2
FB779R	63	10 1/2
FB780R	78	10 3/4

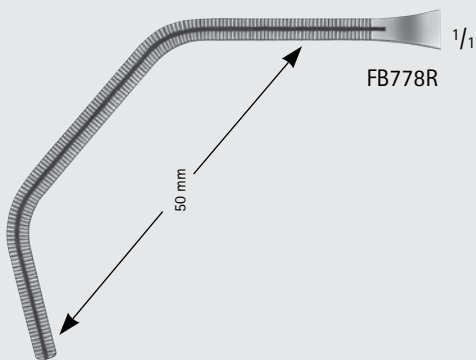
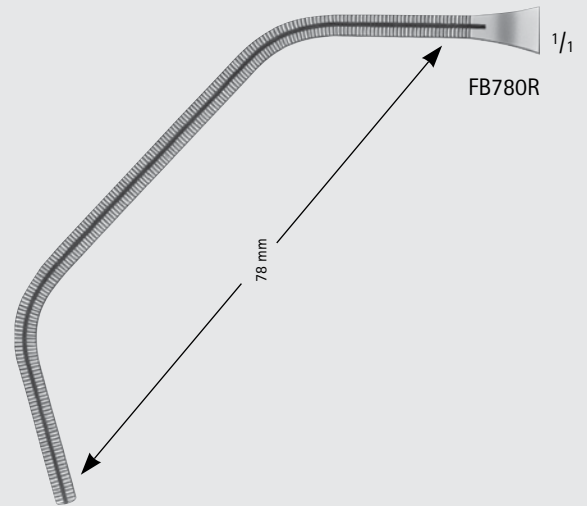
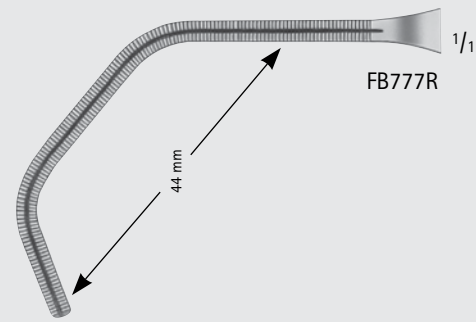
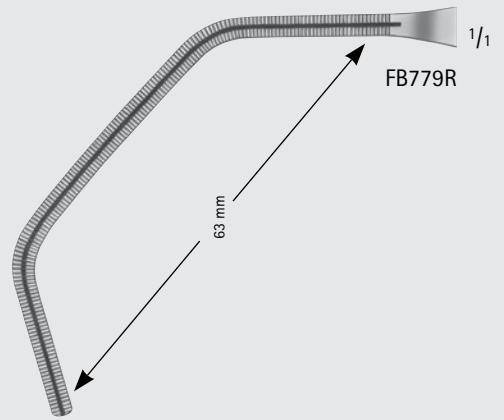
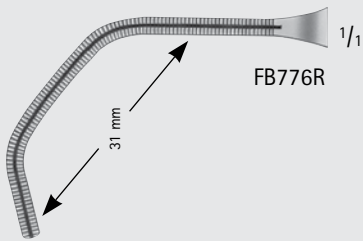

Atraumatic Multi-Purpose Clamp

Catalog Number	Jaw Length (mm)	Jaw	Length (in.)
FC310R	50	STR	6 3/4
FC311R	50	ANG 15°	6 3/4
FC312R	50	ANG 30°	6 3/4
FC313R	50	ANG 45°	6 1/4

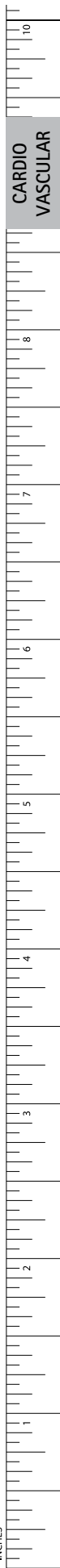
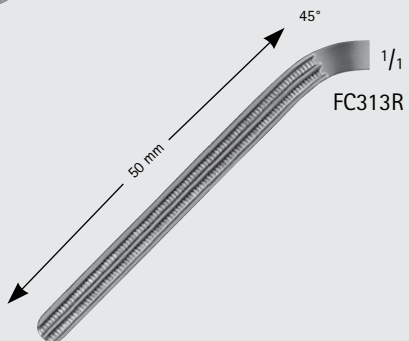
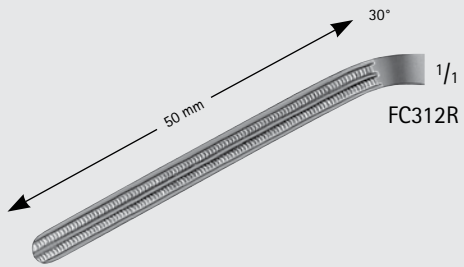
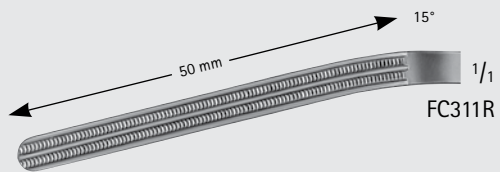
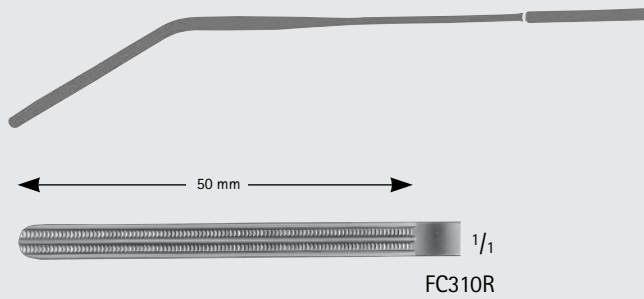
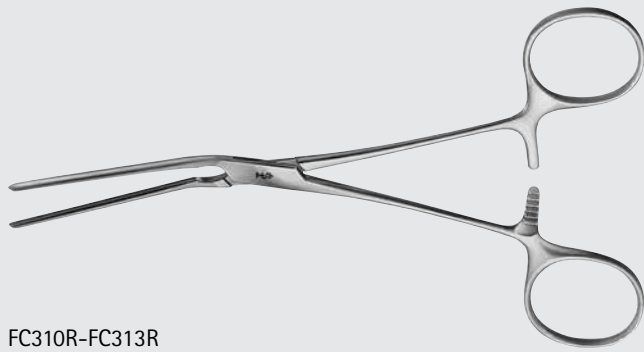

Cardiovascular

Vascular Clamps



CARDIO
VASCULAR

KLINTMALM Liver Transplant Clamp

Catalog Number	Jaw Length (mm)	Length (in.)
MG073R	95	9 3/4

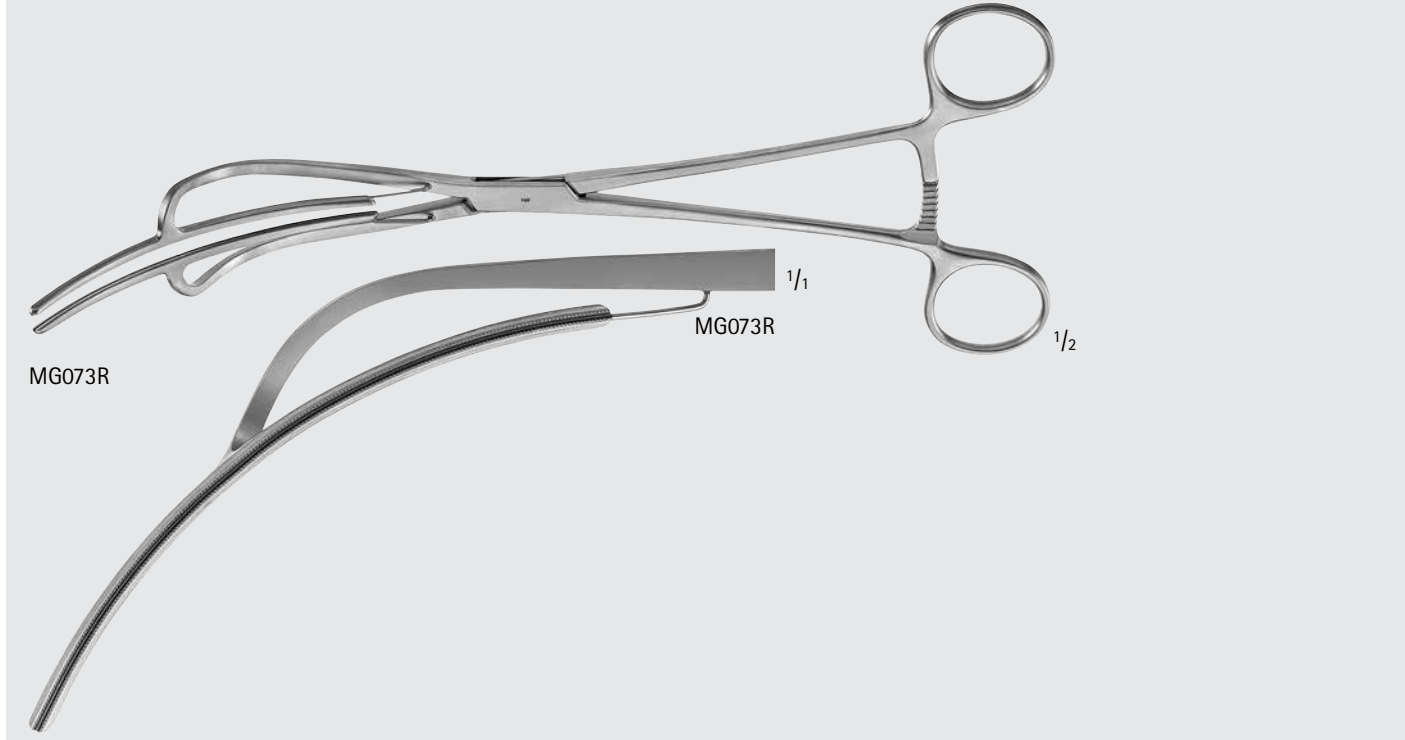

KITZMILLER Clamp

Catalog Number	Jaw	Jaw Length (mm)	Length (in.)
MG012R	ANG LEFT	10	5 1/4
MG013R	ANG RIGHT	10	5 1/4

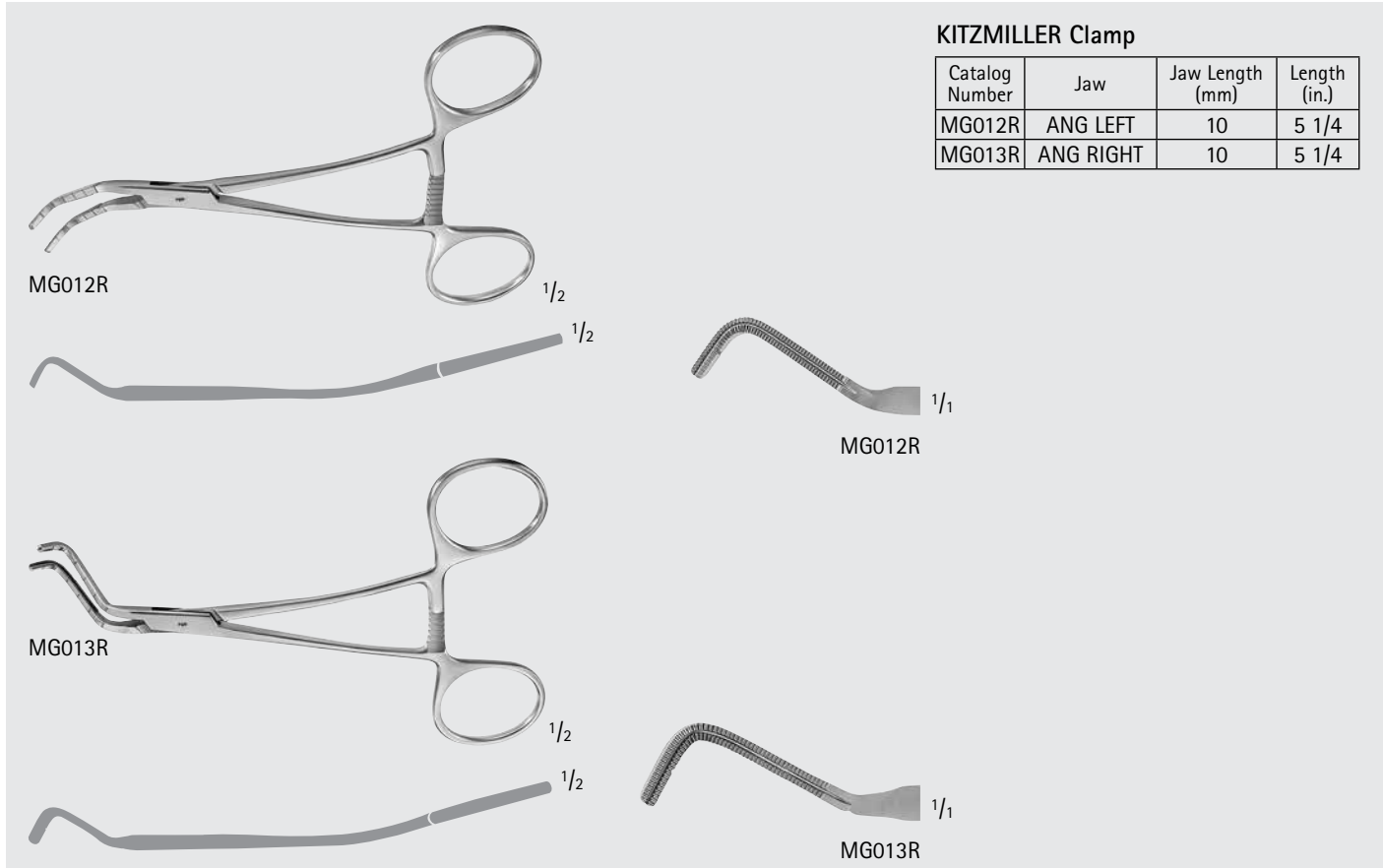

Cardiovascular

Vascular Clamps

POTTS Liver Clamp W/ Teeth

Catalog Number	Size	Length (in.)
MB481R	SMALL	10
MB482R	MEDIUM	10 1/4
MB483R	LARGE	10 5/8

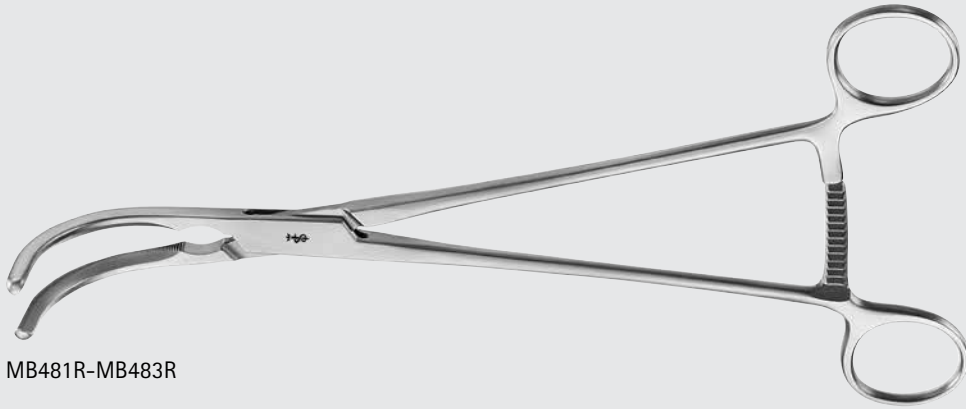

MB481R-MB483R

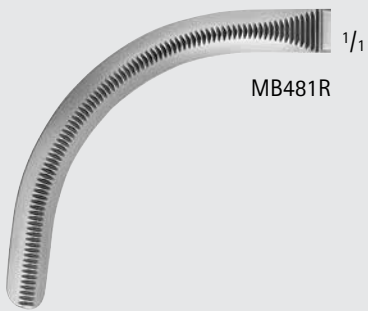

MB481R

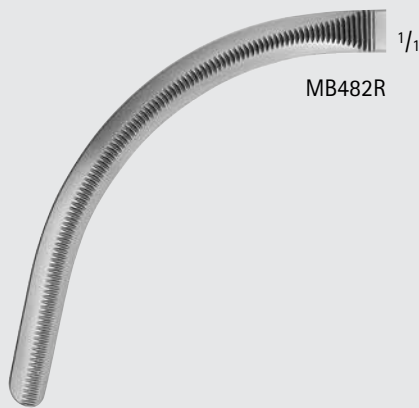

MB482R

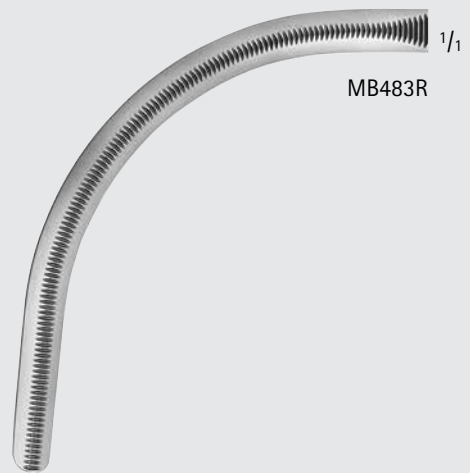

MB483R



Cardiovascular

Vascular Clamps

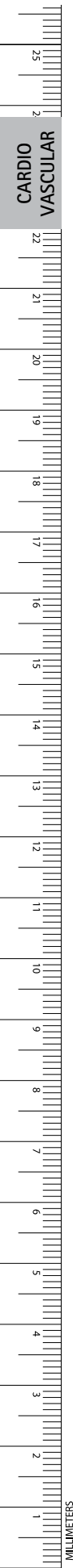

PARSONNET Aorta Clamp

Catalog Number	Jaw Length (mm)	Length (in.)
MB671R	28	9 3/8
MB672R	32	9 5/8
MB673R	38	9 5/8
MB674R	45	10

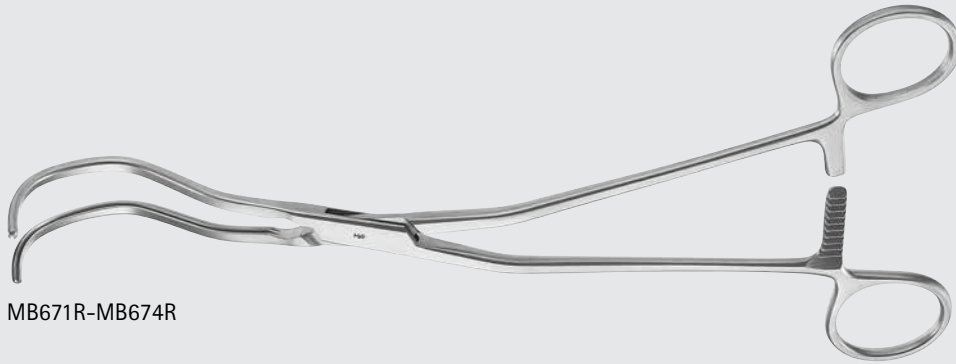

MB671R-MB674R



MB671R



MB672R

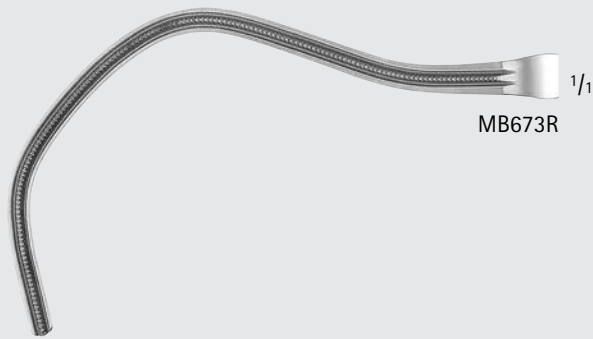

MB673R

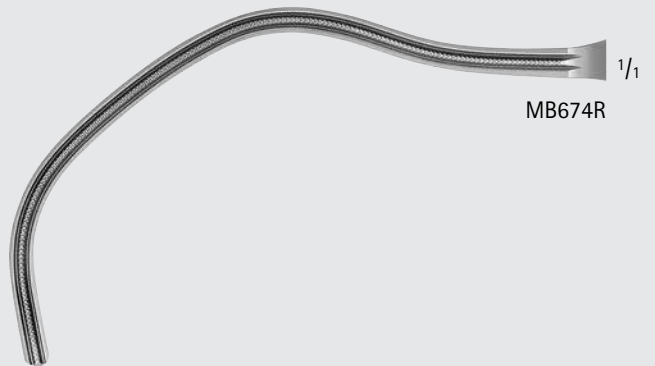

MB674R

Cardiovascular

Vascular Clamps

JAVID Carotid Artery Bypass Shunt Clamp

Catalog Number	Jaw	Length (in.)
MB238R	4 MM RING	6 5/8
MB239R	6 MM RING	7

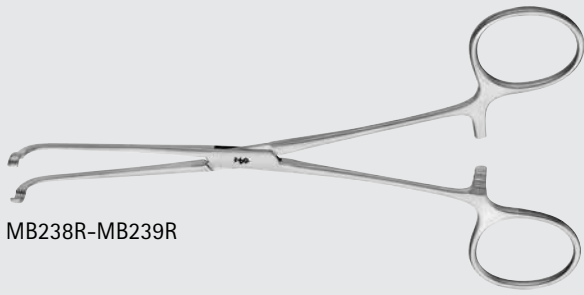

MB238R-MB239R



MB238R

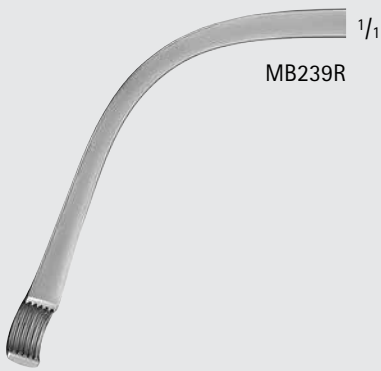

MB239R



Cardiovascular

Bulldog and Micro Vessel Clamps



CARDIO
VASCULAR

JOHNS-HOPKINS Apply/Remove Forceps

Catalog Number	Length (in.)
BH018R	9 1/2

Forceps for applying and removing bulldog clamps BH011R - BH031R and FB420R - FB427R

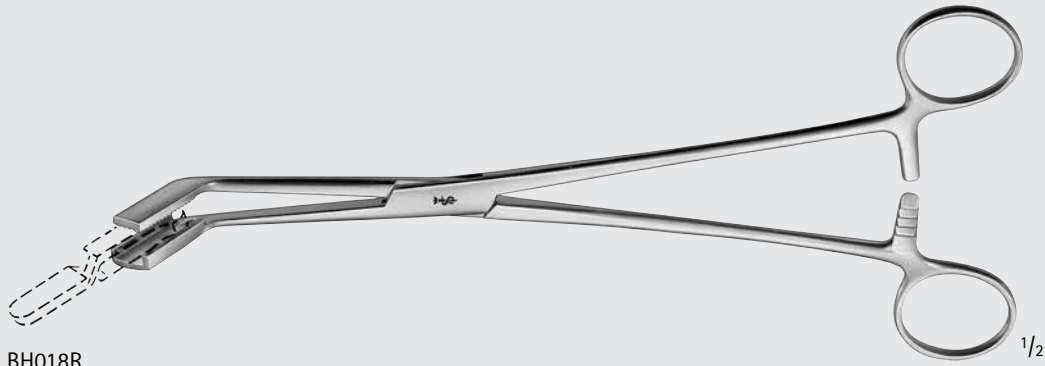

BH018R

JOHNS-HOPKINS Bulldog Clamp

Catalog Number	Jaw	Jaw Length (mm)	Length (in.)
BH011R	CVD	12	1 1/2
BH012R	CVD	17	1 7/8
BH013R	CVD	25	2 1/8
BH014R	CVD	30	2 1/2
BH015R	CVD	33	2 3/4
BH016R	CVD	42	3 1/8
BH017R	CVD	52	3 1/2



BH011R-BH017R

DIEFFENBACH Bulldog Clamp

Catalog Number	Jaw	Jaw Length (mm)	Length (in.)
BH020R	STR	12	1 1/2
BH022R	STR	16	1 7/8
BH026R	STR	16	2 1/8
BH021R	CVD	12	1 1/2
BH023R	CVD	16	1 7/8
BH027R	CVD	16	2 1/8



BH020R



BH026R



BH021R



BH027R



MG082R



MG083R



MG084R

Bulldog Clamp, Lightweight

Catalog Number	Jaw	Jaw Length (mm)	Length (in.)
MG082R	STR	18	1 1/2
MG083R	ANG	18	1 3/8
MG084R	ANG	21	1 1/2



BH030R



BH031R

DEBAKEY-HESS Bulldog Clamp

Catalog Number	Jaw	Jaw Length (mm)	Length (in.)
BH030R	ANG	20	1 3/8
BH031R	ANG	30	1 1/2



MB523R

GREGORY-DEBAKEY Bulldog Clamp

Catalog Number	Jaw	Jaw Length (mm)	Length (in.)
MB523R	ANG	70	4 3/4



FB382R

GREGORY Mini-Bulldog Clamp

Catalog Number	Jaw Length (mm)	Jaw	Length (in.)
FB382R	50	ANG	4 1/8
FB383R	65	ANG	4 3/4



FB383R

Cardiovascular

Bulldog and Micro Vessel Clamps

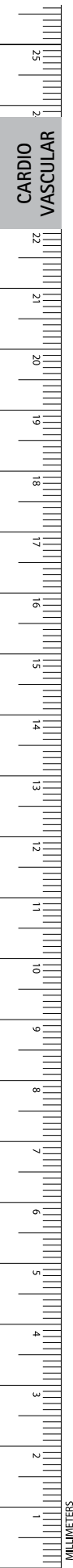

GREGORY Mini-Bulldog Clamp

Catalog Number	Jaw	Jaw Length (mm)	Length (in.)
FB384R	CVD-LEFT	70	4 3/4
FB385R	CVD-RIGHT	70	4 3/4

FB384R-FB385R

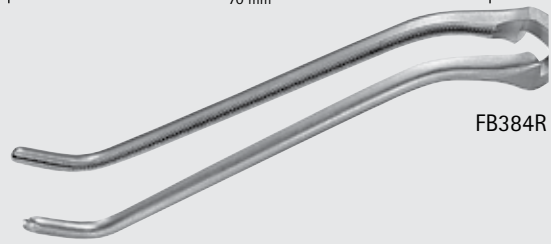

FB384R

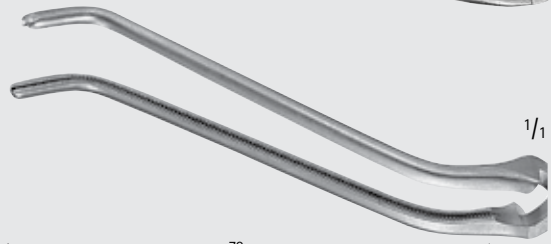

FB385R



FB420R, FB422R, FB424R, FB426R



FB421R, FB423R, FB425R, FB427R

DEBAKEY Atraumatic Mini-Bulldog Clamp

Catalog Number	Jaw	Jaw Length (mm)	Length (in.)
FB420R	STR	20	3 1/8
FB422R	STR	30	3 1/2
FB424R	STR	45	4 1/8
FB426R	STR	65	5
FB421R	CVD	20	3 1/8
FB423R	CVD	30	3 1/4
FB425R	CVD	45	3 3/4
FB427R	CVD	65	4 1/2



FB328R

1/1

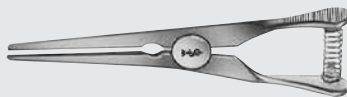

FB330R

1/1



FB329R

1/1



FB331R

1/1

Atraumatic Mini-Bulldog Clamp

Catalog Number	Jaw	Jaw Length (mm)	Length (in.)
FB328R	STR	14	1 3/8
FB330R	STR	19	1 3/4
FB329R	CVD	14	1 3/8
FB331R	CVD	19	1 3/4



MB741R

1/1



MB285R

1/1



BH032R

1/1

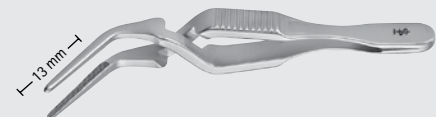

BH034R

1/1

DIETRICH Micro Bulldog Clamp

Catalog Number	Jaw	Jaw Length (mm)	Length (in.)
MB741R	STR	16	2
MB285R	STR	20	2 1/4
BH032R	ANG	10	1 7/8
BH034R	ANG	13	1 7/8



Cardiovascular

Bulldog and Micro Vessel Clamps

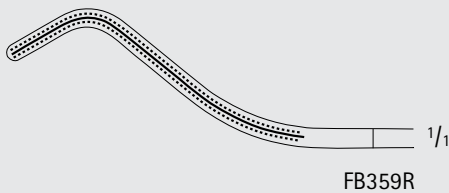
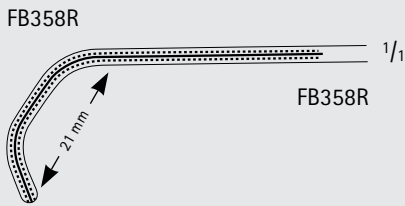
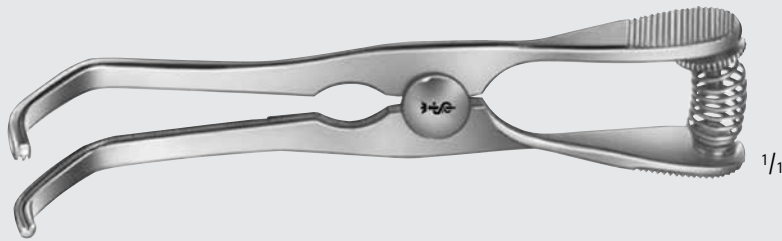
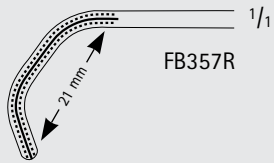

DEBAKEY Atraumatic Mini-Bulldog Clamp

Catalog Number	Jaw Angle	Jaw Length (mm)	Length (in.)
FB352R	STR	20	2
FB353R	CVD	20	1 7/8
FB357R	MULTI	21	3
FB358R	MULTI	42	4
FB359R	S-SHAPED	38	3 3/4

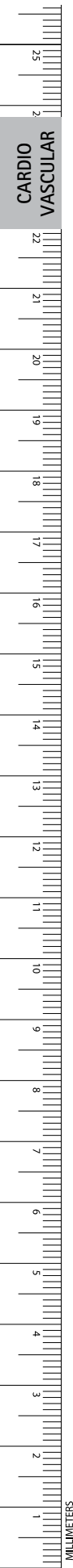



FB431R



FB432R, FB434R, FB436R



FB433R, FB435R, FB437R

GLOVER Atraumatic Mini-Bulldog Clamp

Catalog Number	Jaw Angle	Jaw Length (mm)	Length (in.)
FB431R	75°	20	2
FB432R	STR	25	2 3/4
FB434R	STR	40	3 3/4
FB436R	STR	60	4 1/2
FB433R	CVD	25	2 1/2
FB435R	CVD	40	3 1/2
FB437R	CVD	60	4 1/4

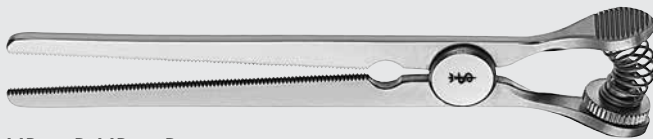

MB737R-MB740R



MB586R-MB589R

COOLEY Atraumatic Bulldog Clamp

Catalog Number	Jaw	Jaw Length (mm)	Length (in.)
MB737R	STR	20	2
MB738R	STR	30	2 1/2
MB739R	STR	45	3 1/4
MB740R	STR	60	5
MB586R	CVD	44	1 3/4
MB587R	CVD	64	2 1/2
MB588R	CVD	75	3 1/8
MB589R	CVD	60	4 3/4

Cardiovascular

Bulldog and Micro Vessel Clamps



FB370R

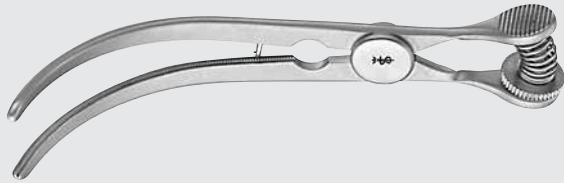

FB374R-FB376R

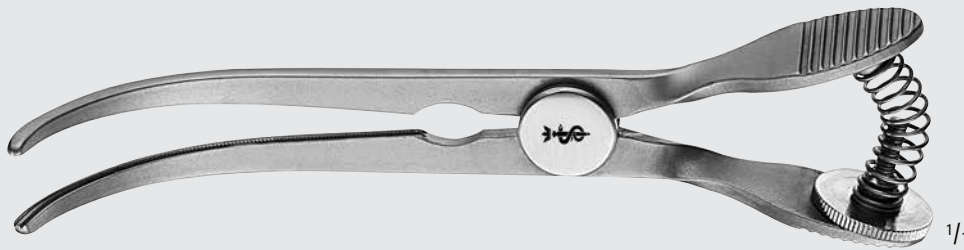

FB377R

GLOVER Atraumatic Bulldog Clamp

Catalog Number	Jaw	Jaw Length (mm)	Length (in.)
FB370R	STR	25	2
FB374R	CVD	20	1 1/2
FB375R	CVD	30	2 3/8
FB376R	CVD	45	3
FB377R	CVD	55	4 3/4

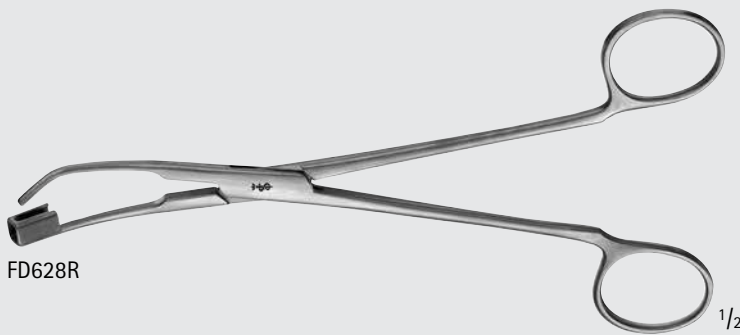

FD628R

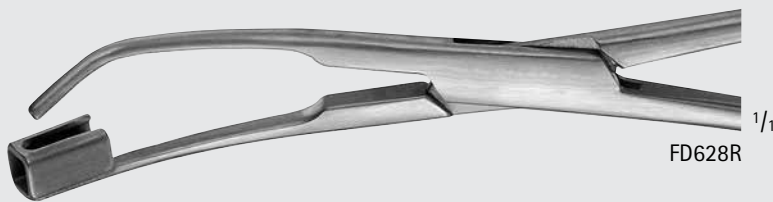

FD628R

SCHWARTZ Apply/Remove Forceps

Catalog Number	Length (in.)
FD628R	7 1/2



FD622R

FD623R

FD624R

SCHWARTZ Micro-Vessel Clamp, Cross-Serrated

Catalog Number	Jaw	Jaw Length (mm)	Closing Force	Length (in.)
FD622R	STR	8	400G	1
FD623R	25°	8	400G	1
FD624R	45°	8	400G	1





FE010K, FE020K

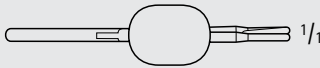

FE010K, FE020K



FE011K, FE021K



FE011K, FE021K



FE012K, FE022K

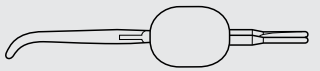

FE012K, FE022K



FE013K, FE023K

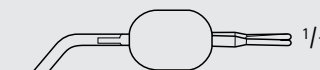

FE013K, FE023K



FE014K, FE024K

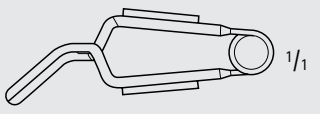

FE014K, FE024K

MUELLER Atraumatic Micro-Vessel Clamp

Catalog Number	Jaw	Closing Force
FE010K	STR	50G
FE020K	STR	80G
FE011K	FULL-CVD	50G
FE021K	FULL-CVD	80G
FE012K	CVD-TIP	50G
FE022K	CVD-TIP	80G
FE013K	ANG	50G
FE023K	ANG	80G
FE014K	LAT-ANG	50G
FE024K	LAT-ANG	80G



FE005K



FE005K

MUELLER Ligature Forceps

Catalog Number	Jaw
FE005K	STR

Cardiovascular

Bulldog and Micro Vessel Clamps

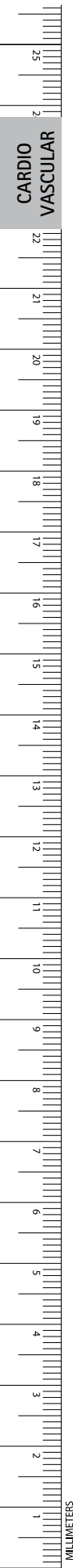

CARDIO
VASCULAR



FE031S, FE041S



FE032S, FE042S



FE030S, FE040S



FE034S, FE044S

MUELLER Alpha Vessel Clamp

Catalog Number	Jaw	Closing Force
FE031S	SLIGHT-CVD	250G
FE041S	SLIGHT-CVD	350G
FE032S	CVD	250G
FE042S	CVD	350G
FE030S	ANG	250G
FE040S	ANG	350G
FE034S	KNEE-BENT	250G
FE044S	KNEE-BENT	350G

NABATOFF Vein Stripper Set

Catalog Number	Description
FB031R	METAL CASE
FB040R	HANDLE
FB033	PLASTIC PROBE TIP
FB034R	METAL PROBE TIP, 3 MM
FB035R	METAL OLIVE, 6 MM
FB036R	METAL OLIVE, 9 MM
FB037R	METAL OLIVE, 12 MM
FB038R	METAL OLIVE, 15 MM

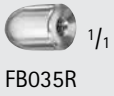

NABATOFF Mini Vein Stripper Set

Catalog Number	Description
FB031R	METAL CASE
FB053R	METAL OLIVE, 3 MM
FB054R	METAL OLIVE, 4 MM
FB055R	METAL OLIVE, 5 MM

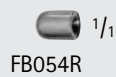

INCHES

Cardiovascular

Vessel Instruments

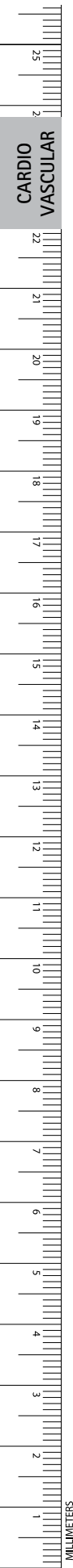

VARADY Varix Dissector, Double Ended

Catalog Number	Tip Size (mm)	Length (in.)
FB120R	0.30 / 0.30	7

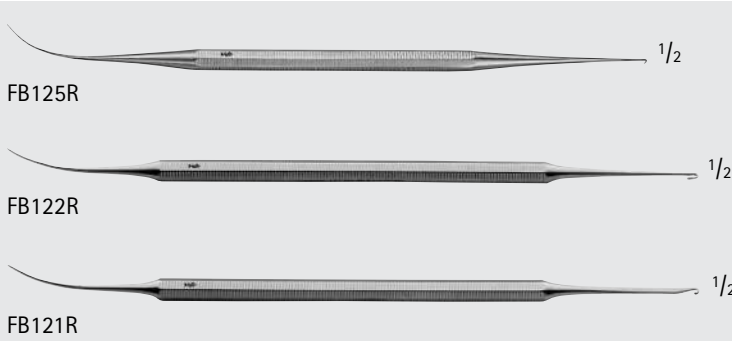

VARADY Varix Extractor, Double Ended W/ Hook

Catalog Number	Tip Size (mm)	Length (in.)
FB125R	0.25 / 0.40	6 3/4
FB122R	0.75 / 0.60	7
FB121R	0.75 / 1.2	7



VARADY Mini-Varix Extractor, Double Ended W/ Hook

Catalog Number	Tip Size (mm)	Length (in.)
FB126R	0.35 / 0.50	6 3/4



VARADY Micro Spatula, Double Ended

Catalog Number	Tip Size (mm)	Length (in.)
FB124R	0.35 / 0.25	6 7/8



Endarterectomy Stripper

Catalog Number	Tip Size (mm)	Length (in.)
FB108R	2	21 3/4
FB109R	3	21 3/4
FB110R	4	21 3/4
FB112R	6	21 3/4
FB113R	7	21 3/4
FB114R	8.5	21 3/4
FB115R	10	21 3/4
FB116R	12	21 3/4
FB117R	14	21 3/4
FB119R	-	4 1/4

FB119R is the handle for FB108R-FB117R

FB108R-FB117R

○ 1/1

FB108R

○ 1/1

FB109R

○ 1/1

FB110R

○ 1/1

FB112R

○ 1/1

FB113R

○ 1/1

FB114R

○ 1/1

FB115R

○ 1/1

FB116R

○ 1/1

FB117R



FB119R



CARDIO
VASCULAR

INCHES

Cardiovascular

Specialty CV/Thoracic Instruments



FB150R-FB151R



1/1

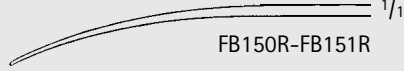

1/1

FB150R-FB151R

Vascular Spatula, Blunt, 3 mm

Catalog Number	Length (in.)
FB150R	7 1/4
FB151R	8 1/2



MB063R

1/2



1/1

MB063R

JACOBSON Endarterectomy Spatula

Catalog Number	Length (in.)
MB063R	7



1/2

FB160R-FB172R, MG008R-MG010R

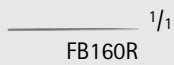

1/1

FB160R

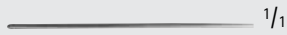

1/1

FB161R



1/1

FB162R

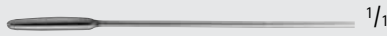

1/1

FB163R



1/1

FB164R

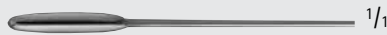

1/1

FB165R



1/1

FB166R



1/1

FB167R

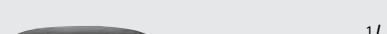

1/1

FB168R

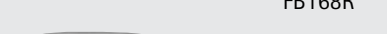

1/1

FB169R

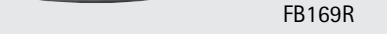

1/1

MG008R

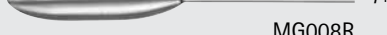

1/1

FB170R



1/1

MG009R



1/1

FB172R

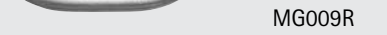

1/1

MG010R

DEBAKEY Vascular Dilator, Malleable

Catalog Number	Tip Size (mm)	Length (in.)
MG011R	SET OF 12	-
MG055R	SET OF 5	-
FB160R	0.5	7 1/2
FB161R	1.0	7 1/2
FB162R	1.5	7 1/2
FB163R	2.0	7 1/2
FB164R	2.5	7 1/2
FB165R	3.0	7 1/2
FB166R	3.5	7 1/2
FB167R	4.0	7 1/2
FB168R	4.5	7 1/2
FB169R	5.0	7 1/2
MG008R	6.0	7 1/2
FB170R	7.0	7 1/2
MG009R	8.0	7 1/2
FB172R	9.0	7 1/2
MG010R	10.0	7 1/2

MG011R Includes:

1 Dilator of each FB161R-165R, FB167R, FB169R, MG008R, FB170R, MG009R, FB172R, MG010R

MG055R Includes:

1 Dilator of each FB161R-165R



Cardiovascular
Specialty CV/Thoracic Instruments

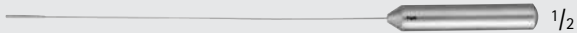
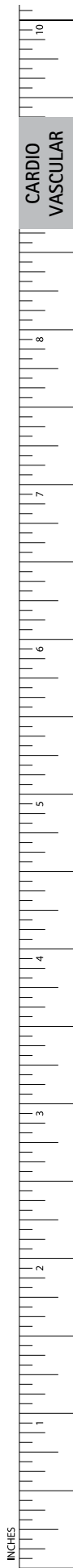

MB246-MB254

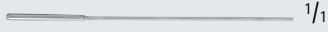

MB246

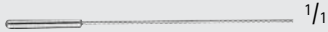

MB247



MB248

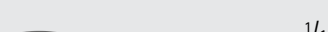

MB249

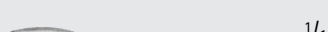

MB250

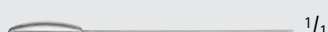

MB251

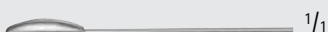

MB252

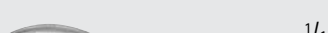

MB253

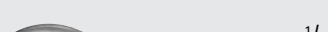

MB254



MB255

GARRETT Vascular Dilator

Catalog Number	Tip Size (mm)	Length (in.)
MB245	COMPLETE SET	5 1/2
MB246	1.0	5 1/2
MB247	1.5	5 1/2
MB248	2.0	5 1/2
MB249	2.5	5 1/2
MB250	3.0	5 1/2
MB251	3.5	5 1/2
MB252	4.0	5 1/2
MB253	4.5	5 1/2
MB254	5.0	5 1/2
MB255	TUBE	5 1/2

MB245 Includes:
1 Dilator of each MB246-MB254

MB255:
Tube for GARRETT Vascular Dilators
MB245-MB254

Cardiovascular

Specialty CV/Thoracic Instruments

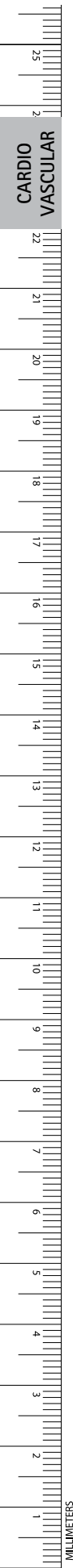

CARDIO
VASCULAR

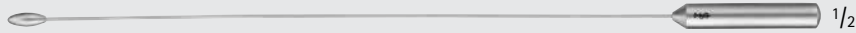

MB257-MB265



MB257

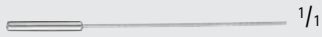

MB258

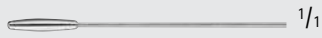

MB259



MB260

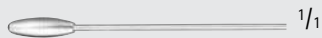

MB261

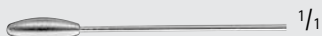

MB262



MB263

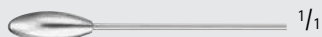

MB264



MB265



MB266

GARRETT Vascular Dilator

Catalog Number	Tip Size (mm)	Length (in.)
MB256	COMPLETE SET	8 1/2
MB257	1.0	8 1/2
MB258	1.5	8 1/2
MB259	2.0	8 1/2
MB260	2.5	8 1/2
MB261	3.0	8 1/2
MB262	3.5	8 1/2
MB263	4.0	8 1/2
MB264	4.5	8 1/2
MB265	5.0	8 1/2
MB266	TUBE	8 1/2

MB256 Includes:

1 Dilator of each MB257-MB265

MB266:

Tube for GARRETT Vascular Dilator



MG051R-MG054R



MG053R



MG052R



MG051R



MG054R

Aortic Arch Dilator

Catalog Number	Tip Size (mm)	Length (in.)
MG053R	5	8
MG051R	6	8
MG052R	8	8
MG054R	9.5	8



FB153R-FB156R



FB153R



FB154R



FB155R



FB156R

**SCHMID Vessel Irrigation Cannula,
Silver Plated**

Catalog Number	Tip Size (mm)	Length (in.)
FB153R	3	6
FB154R	4	6
FB155R	5	6
FB156R	6	6



MD610-MD611

Heparin Needle

Catalog Number	Gauge	Length (in.)
MD610	13	3 1/2
MD611	18	3 3/4

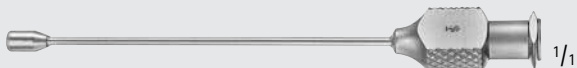

MB601R

ZANGER Heparin Cannula, Malleable

Catalog Number	Tip Size (mm)	Length (in.)
MB601R	3.5	2 3/4



MB602R

IMA Heparin Cannula, Malleable

Catalog Number	Tip Size (mm)	Length (in.)
MB602R	1.5	2 1/8



MB634R

Luer Lock Adapter

Catalog Number	Length (in.)
MB634R	1 1/2

Cardiovascular

Specialty CV/Thoracic Instruments

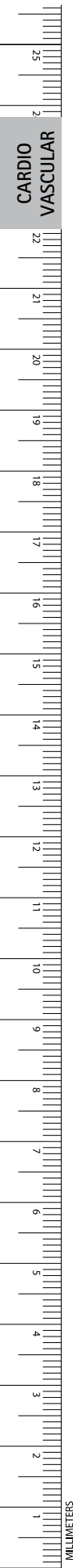

CARDIO
VASCULAR



FK340R

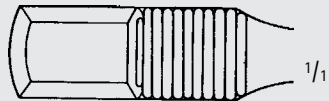
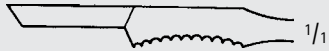

FK340R



FK341R

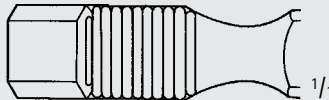

FK341R

FARABEUF Elevator

Catalog Number	Tip Size (mm)	Blade Shape	Length (in.)
FK340R	12.5	STR	5 3/4
FK341R	12.5	CVD	5 1/4



FK344R

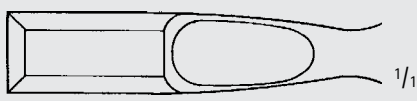
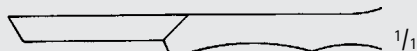

FK344R



FK345R

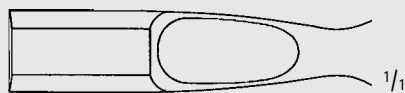

FK345R

FARABEUF-COLLIN Elevator

Catalog Number	Tip Size (mm)	Blade Shape	Length (in.)
FK344R	11	STR	6 1/4
FK345R	11	CVD	6 1/4



MB812R

MATSON Rib Stripper/Elevator

Catalog Number	Length (in.)
MB812R	8 3/4



FK355R-FK359R

LAMBOTTE Rib Elevator

Catalog Number	Tip Size (mm)	Length (in.)
FK355R	5	8 1/2
FK356R	10	8 1/2
FK357R	15	8 1/2
FK358R	20	8 1/2
FK359R	25	8 1/2

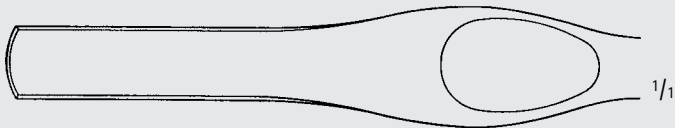
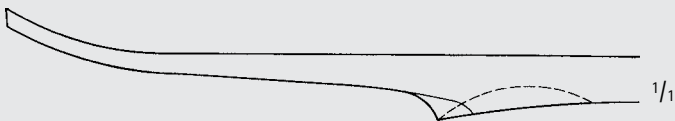

FK355R-FK359R

Cardiovascular

Specialty CV/Thoracic Instruments

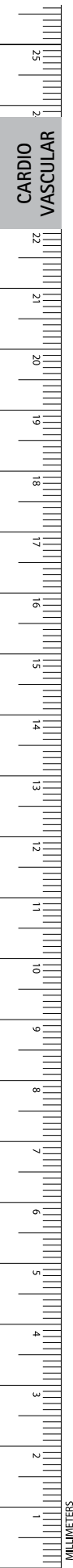

CARDIO
VASCULAR



FK381R-FK387R

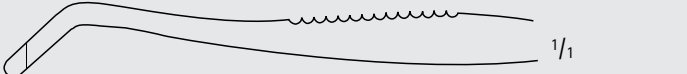

FK381R



FK382R

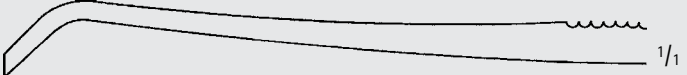

FK383R

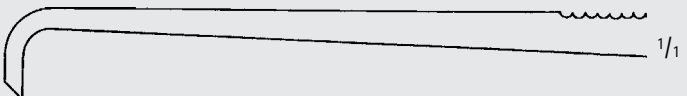

FK384R

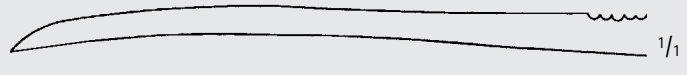

FK387R

SEMB Elevator

Catalog Number	Tip Size (mm)	Length (in.)
FK381R	12	7 1/2
FK382R	12	9
FK383R	13	9
FK384R	13	9
FK387R	15	9

DOYEN Elevator

Catalog Number	Blade End	Blade Shape	Length (in.)
FK400R	PEDIATRIC	LEFT-CVD	6 7/8
FK402R	ADULT	LEFT-CVD	6 7/8
FK401R	PEDIATRIC	RIGHT-CVD	6 7/8
FK403R	ADULT	RIGHT-CVD	6 7/8
FK408R	-	LEFT-CVD	9 1/2
FK409R	-	RIGHT-CVD	9 1/2



FK400R-FK402R

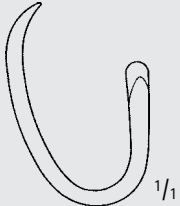

FK400R

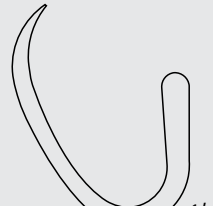

FK402R



FK401R-FK403R

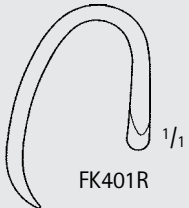

FK401R

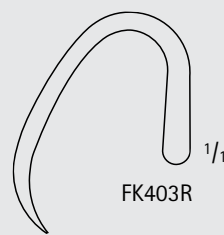

FK403R



FK408R

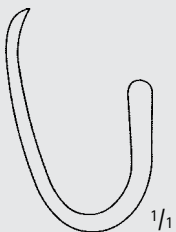

FK408R



FK409R

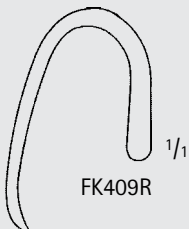

FK409R

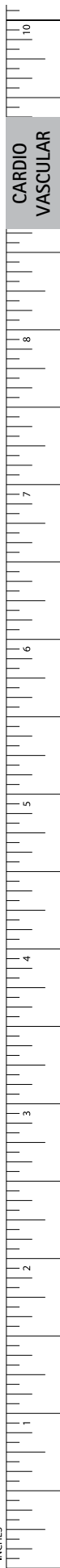

Cardiovascular

Specialty CV/Thoracic Instruments

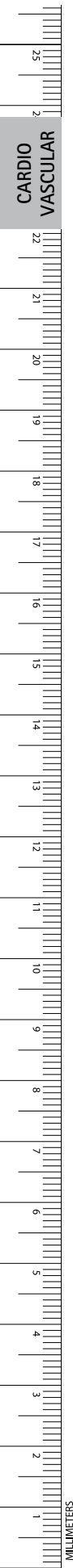

FK420R

ALEXANDER Elevator

Catalog Number	Tip Size (mm)	Length (in.)
FK420R	12	8 1/4

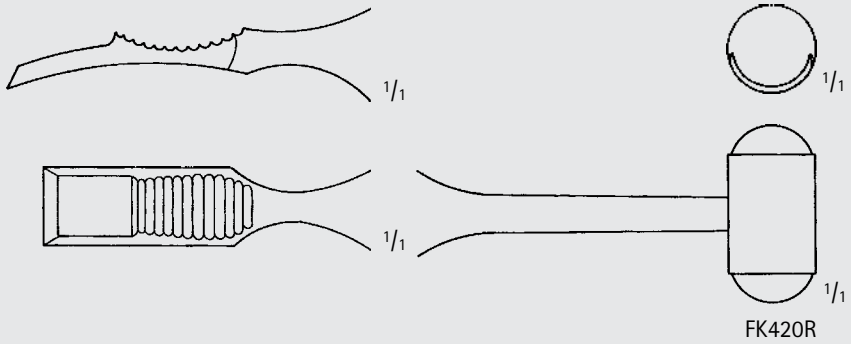

FB870R

Rib Shears

Catalog Number	Blade	Length (in.)
FB870R	S/B	9



FB873R

GLUCK Rib Shears

Catalog Number	Length (in.)
FB873R	7 1/2

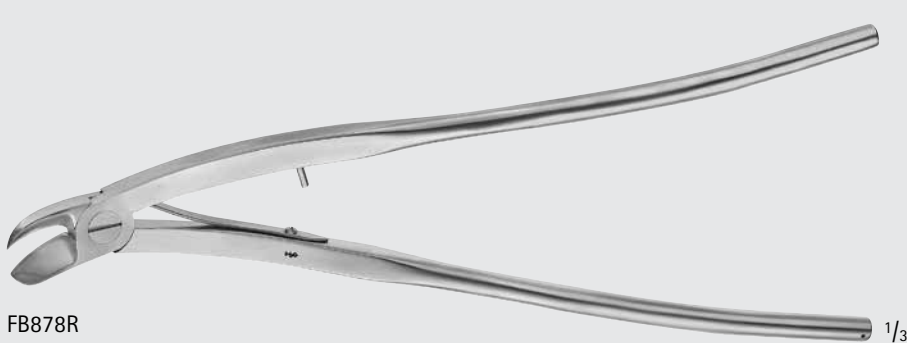

FB878R

BETHUNE Rib Shears

Catalog Number	Length (in.)
FB878R	13 3/8

Cardiovascular
Specialty CV/Thoracic Instruments



FB881R-FB882R

SAUERBRUCH Rib Shears

Catalog Number	Size	Length (in.)
FB881R	PEDIATRIC	9 1/2
FB882R	ADULT	10 5/8

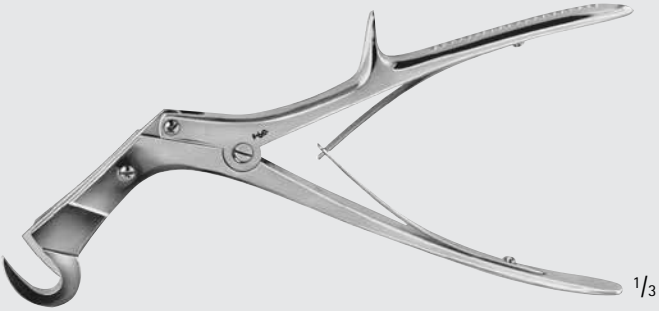

FB890R

GIERTZ-STILLE Rib Shears

Catalog Number	Length (in.)
FB890R	9 3/4



MG094R

SWEET Sternum Punch

Catalog Number	Length (in.)
MG094R	10

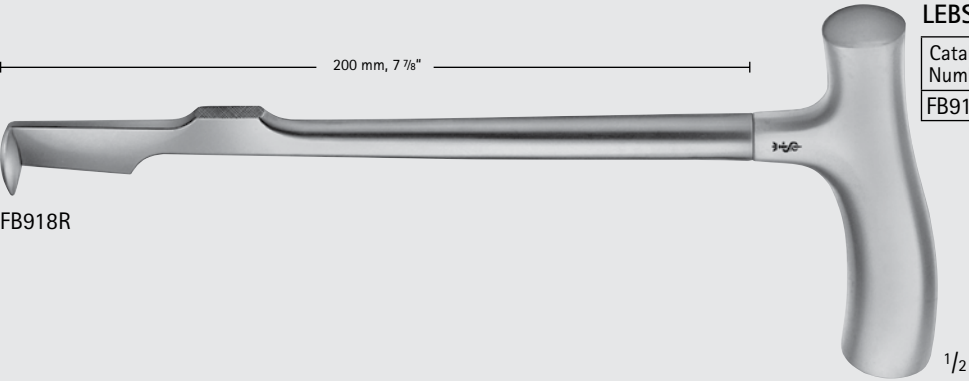

FB918R

LEBSCHKE Sternum Chisel

Catalog Number	Length (in.)
FB918R	9 3/4

200 mm, 7 7/8"

Cardiovascular

Specialty CV/Thoracic Instruments

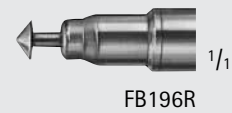
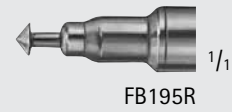
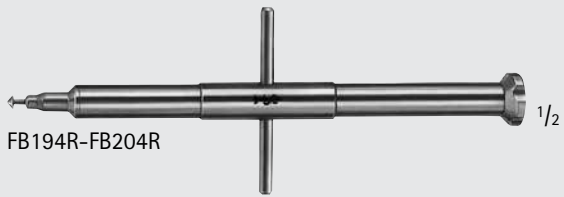
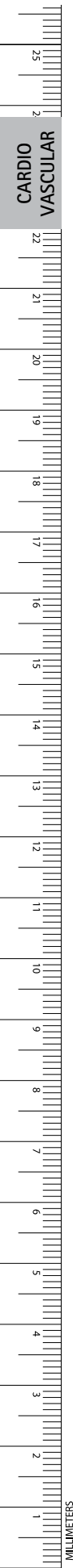

Aorta Punch

Catalog Number	Tip Size (mm)	Length (in.)
FB201R	3.0	5 1/2
FB202R	3.5	5 1/2
FB194R	4.0	5 1/2
FB203R	4.5	5 1/2
FB195R	5.0	5 1/2
FB204R	5.5	5 1/2
FB196R	6.0	5 1/2

Valvulotome

Catalog Number	Tip	Length (in.)
MB360R	ANTEGRADE	6 3/8
MB358R	RETROGRADE	9 1/2
MB359R	RETROGRADE	12 1/4

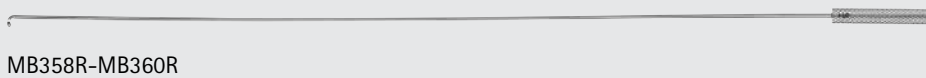

Cardiovascular Specialty CV/Thoracic Instruments

JENKNER Tunnelling Instruments

Catalog Number	Diameter (mm)	Description	Length (in.)
FC004R	12	TUNNELLING TUBE W/ CONICAL TIP	16
FC005R	12	TUNNELLING TUBE W/ CONICAL TIP	20
FC014R	14	TUNNELLING TUBE W/ CONICAL TIP	16
FC015R	14	TUNNELLING TUBE W/ CONICAL TIP	20
FC034R	5	TUNNELLING FORCEPS F/ FC004R/ FC014R	16
FC035R	5	TUNNELLING FORCEPS F/ FC005R/ FC015R	20
FC030	-	HANDLE F/ TUNNELLING TUBES	-

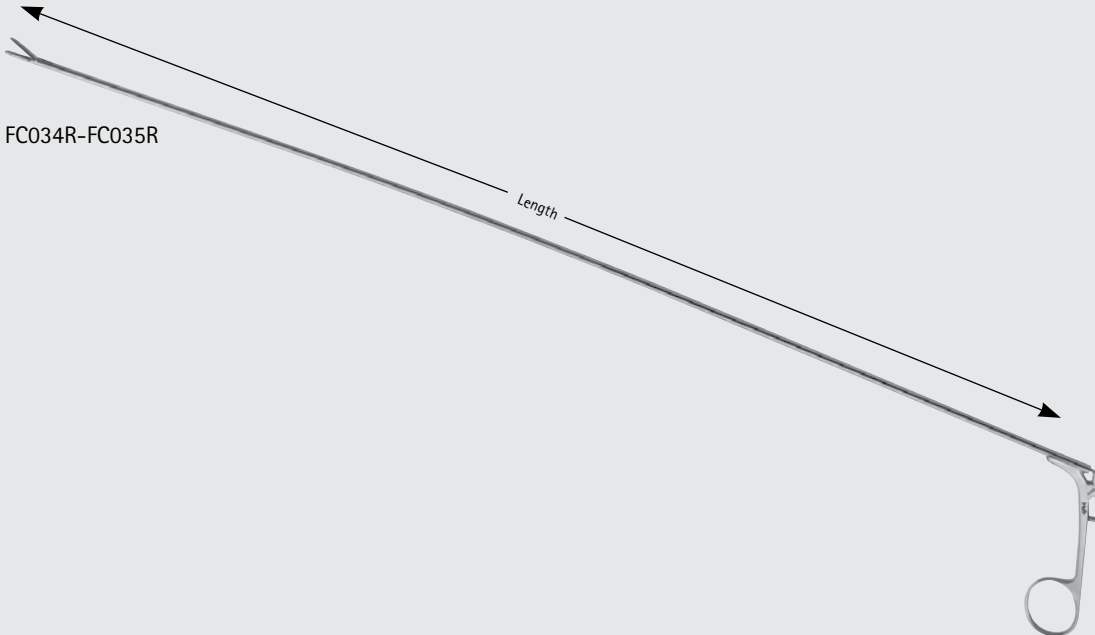
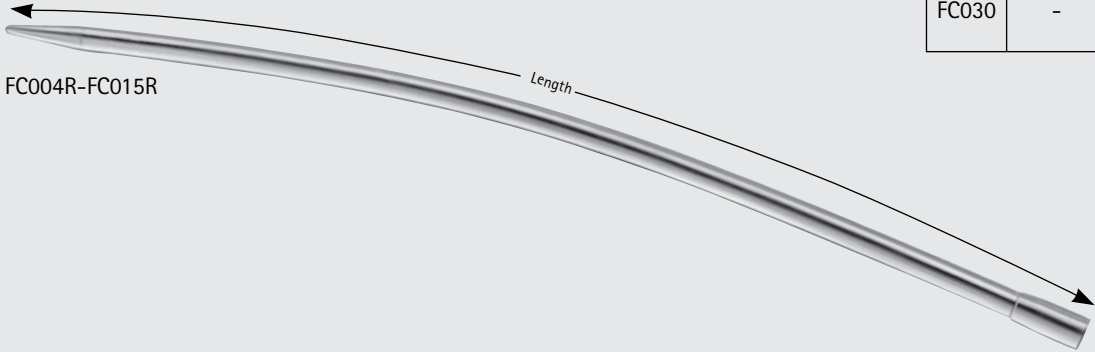

Cardiovascular

Specialty CV/Thoracic Instruments

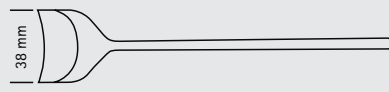
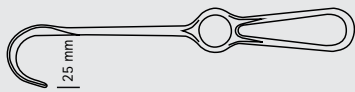

Dimensions for blade size of retractors
 1st number = depth Example: 25 x 38 mm
 2nd number = width



BT082R-BT083R



BT082R

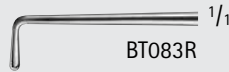

BT083R



BT084R



BT084R

CUSHING Vessel Hook

Catalog Number	Tip Size (mm)	Tip	Length (in.)
BT082R	1 x 4	BLUNT	7 1/2
BT083R	1 x 7	BLUNT	7 1/2
BT084R	1 x 6	BLUNT	11



BT080R

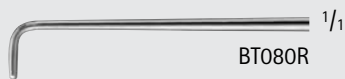

BT080R

CRILE Vessel Hook

Catalog Number	Tip Size (mm)	Tip	Length (in.)
BT080R	1.5 x 9	BLUNT	7 7/8

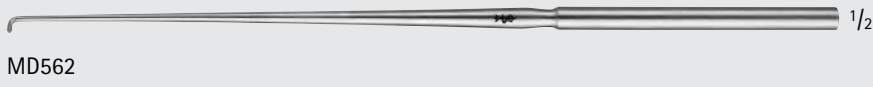

MD562



MD562

DANDY Nerve Hook

Catalog Number	Tip Size (mm)	Tip	Length (in.)
MD562	1 x 8	BLUNT	8 3/4

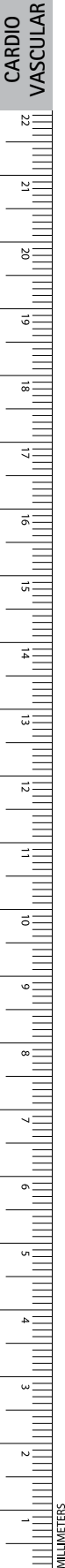

Cardiovascular

Specialty CV/Thoracic Instruments and Retractors



Blunt Hook

Catalog Number	Tip Size (mm)	Tip	Length (in.)
MG369R	2	RND	7

JACOBSON Probe

Catalog Number	Tip	Length (in.)
FD311R	ANG, SINGLE PROBE	7 1/4
FD312R	STR, DOUBLE PROBE	7 1/4

BREWSTER Retractor

Catalog Number	Blade Size (mm)	Blade	Length (in.)
MB933R	25 x 45	CVD CONVEX	9

Cardiovascular

Retractors



BV014R



PARSONNET Epicardial Retractors

Catalog Number	Blade End	Tip	Length (in.)
BV014R	3 x 3 PRONGS	SHARP	2



BV021R-BV024R

IMA Epicardial Retractor

Catalog Number	Blade End	Tip	Length (in.)
BV021R	3 x 3 PRONGS	SHARP	1
BV022R	3 x 3 PRONGS	SHARP	1 1/4
BV023R	3 x 3 PRONGS	SHARP	1 1/2
BV024R	3 x 3 PRONGS	SHARP	2



MB047R-MB048R, MB700R-MB703R

ROSS Aortic Valve Retractor

Catalog Number	Blade Size (mm)	Length (in.)
MB047R	15 x 15	10
MB048R	13 x 22	10
MB700R	17 x 24	10
MB701R	13 x 27	10
MB702R	30 x 28	10
MB703R	40 x 25	10



MB047R



MB048R



MB700R



MB701R



MB702R



MB703R





FB923R-FB927R

1/2

COOLEY Atrium Retractor, Left

Catalog Number	Blade Size (mm)	Length (in.)
FB923R	25 x 20	9 5/8
FB924R	25 x 25	9 5/8
FB925R	25 x 30	9 5/8
FB926R	25 x 35	9 5/8
FB927R	25 x 45	9 5/8



25 x 20 mm

FB923R

1/1



25 x 25 mm

FB924R

1/1

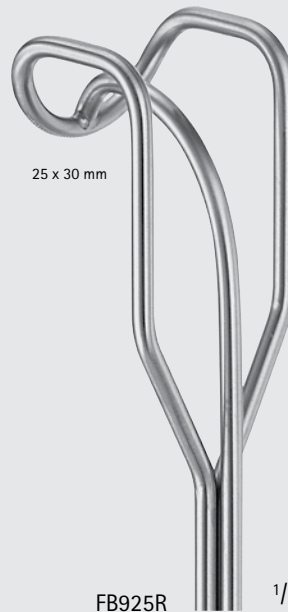

25 x 30 mm

FB925R

1/1

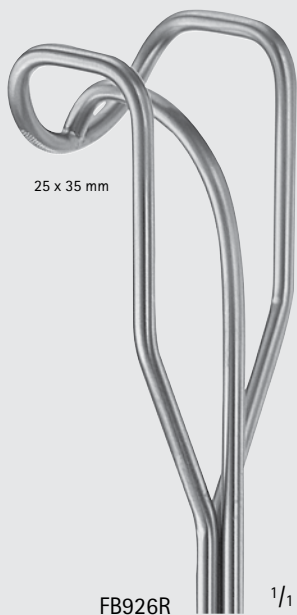

25 x 35 mm

FB926R

1/1

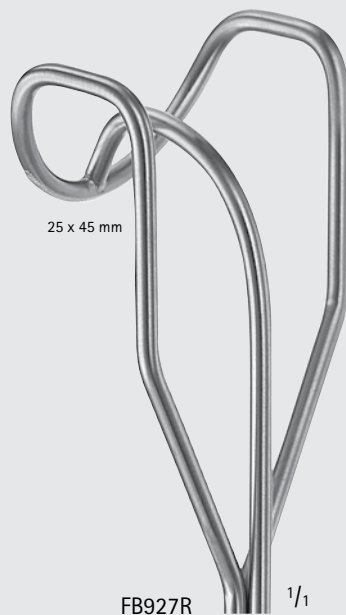

25 x 45 mm

FB927R

1/1



INCHES

Cardiovascular

Retractors

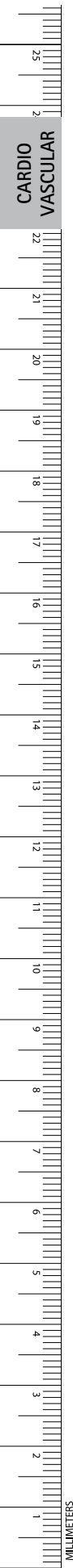

COOLEY Atrium Retractor, Right

Catalog Number	Blade Size (mm)	Length (in.)
FB963R	25 x 20	9 1/4
FB964R	40 x 25	9 1/4
FB965R	40 x 30	9 1/4
FB966R	40 x 35	9 1/4
FB967R	40 x 45	9 1/4
FB968R	50 x 35	9 1/4

FB963R-FB968R



25 x 20 mm

FB963R

1/1

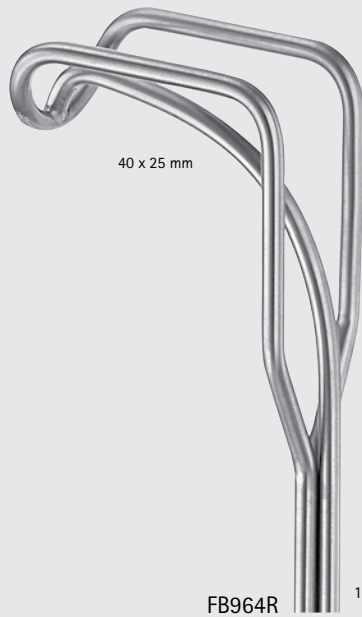

40 x 25 mm

FB964R

1/1

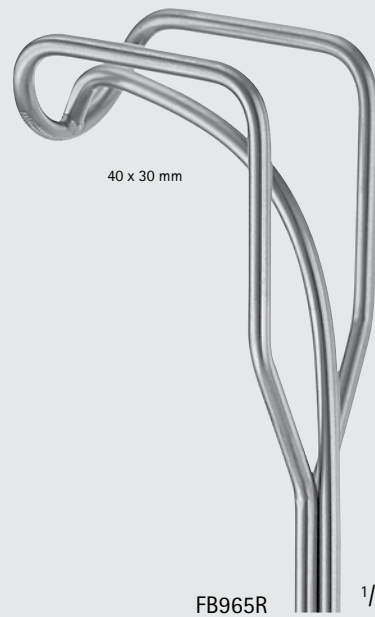

40 x 30 mm

FB965R

1/1

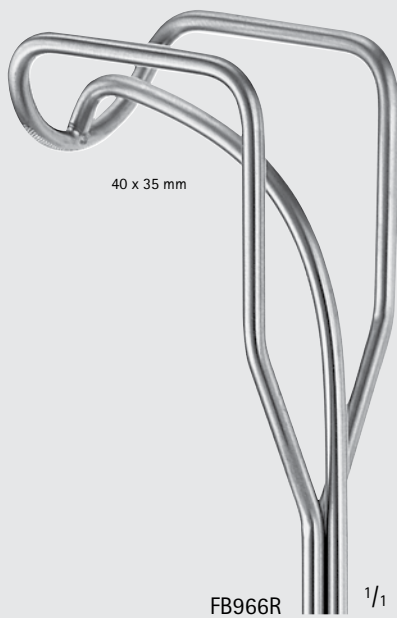

40 x 35 mm

FB966R

1/1

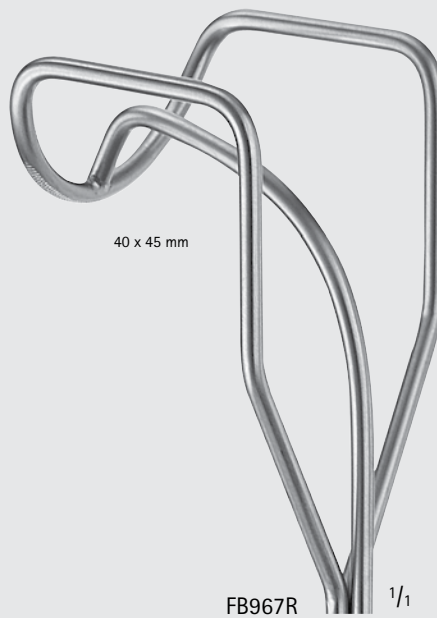

40 x 45 mm

FB967R

1/1

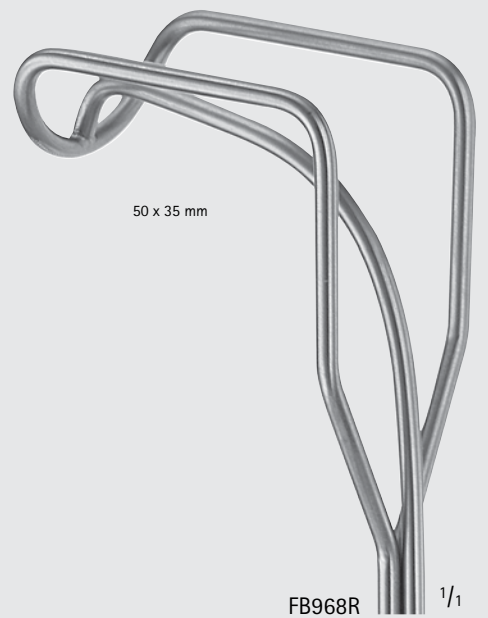

50 x 35 mm

FB968R

1/1

COOLEY Atrial Retractor, Right

Catalog Number	Blade Size (mm)	Length (in.)
MB383R	22 x 19	9 1/4
MB385R	29 x 19	9 1/4
MB386R	38 x 38	9 1/4
MB387R	48 x 44	9 1/4

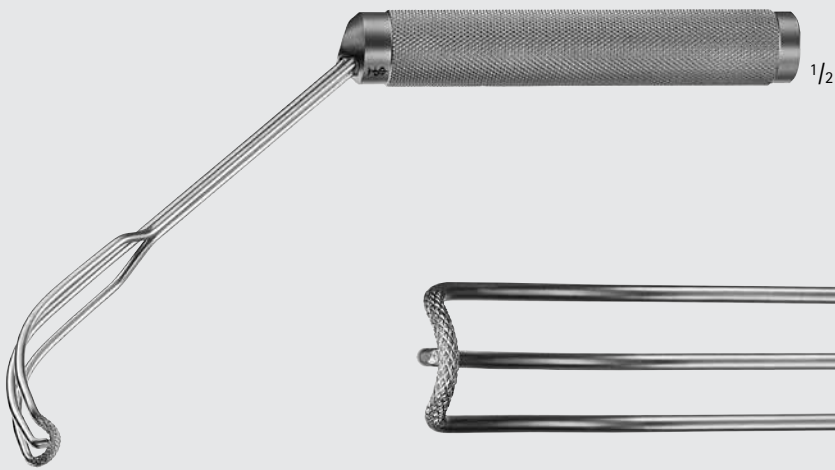

MB383R-MB387R

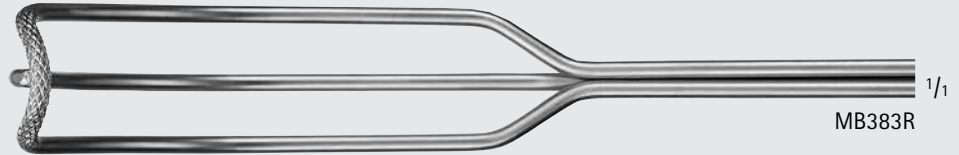

MB383R

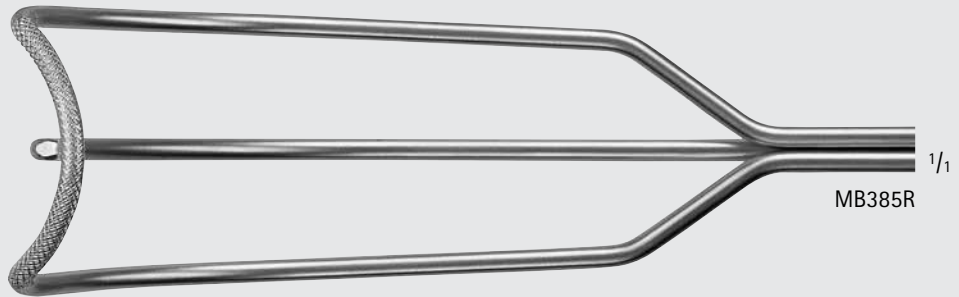

MB385R

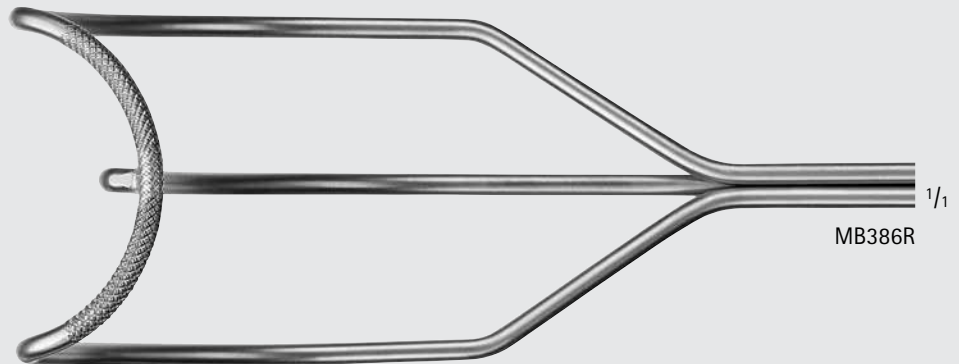

MB386R

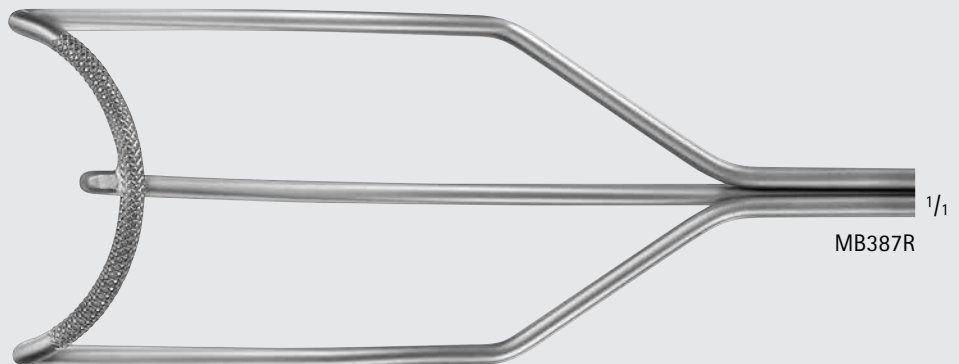

MB387R



Cardiovascular

Retractors

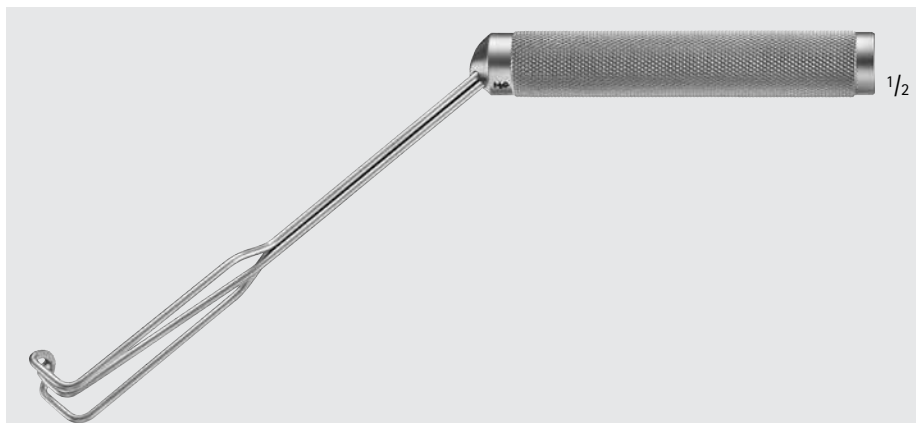
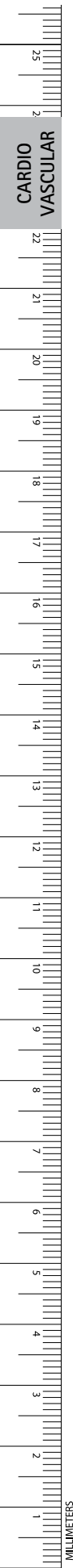

MB356R-MB357R

COOLEY Atrial Retractor, Left

Catalog Number	Blade Size (mm)	Length (in.)
MB356R	19 x 38	9 1/4
MB357R	19 x 44	9 1/4

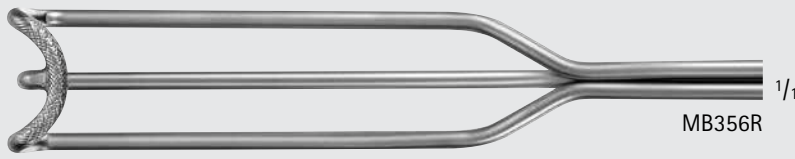

MB356R

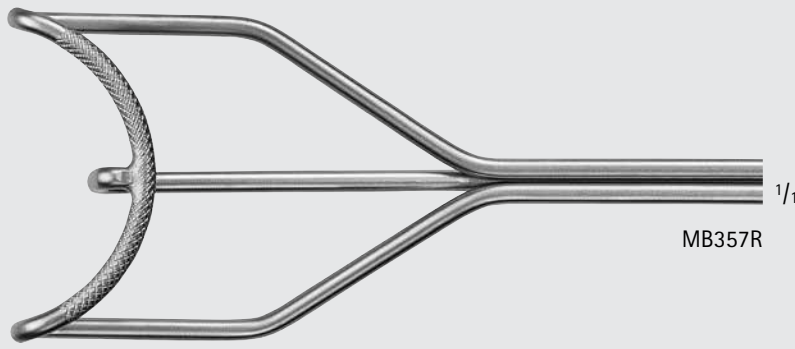

MB357R

Cardiovascular Retractors

KRASKY Retractor

Catalog Number	Blade End	Tip	Blade Size (mm)	Length (in.)
MG067R	6 PRONGS	SHARP	51 x 25	11

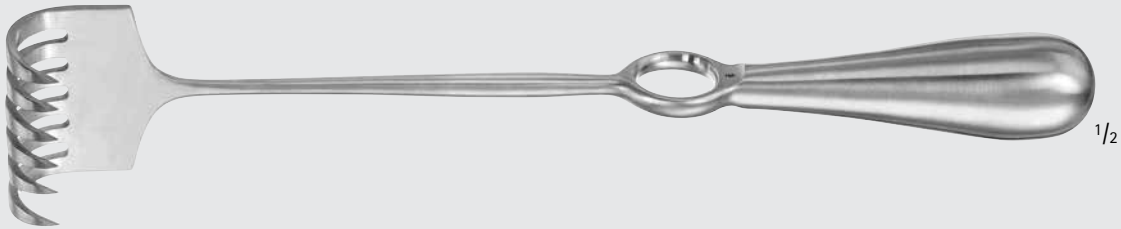

1/2

MG067R



1/1

MG067R



Cardiovascular

Retractors

CORYLLOS Retractor

Catalog Number	Blade Size (mm)	Length (in.)
BT521R	80 x 20	10
BT522R	115 x 38	10
BT523R	115 x 65	10

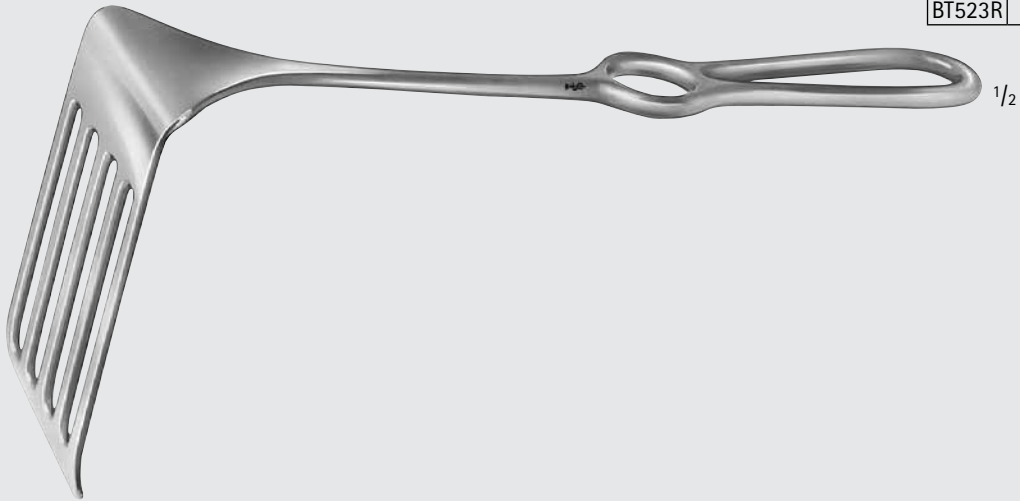

BT521R-BT523R

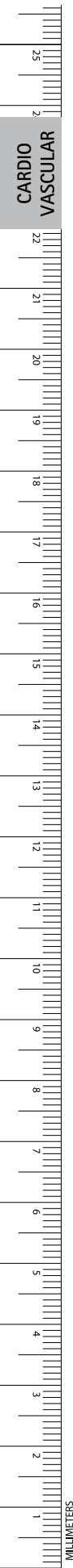
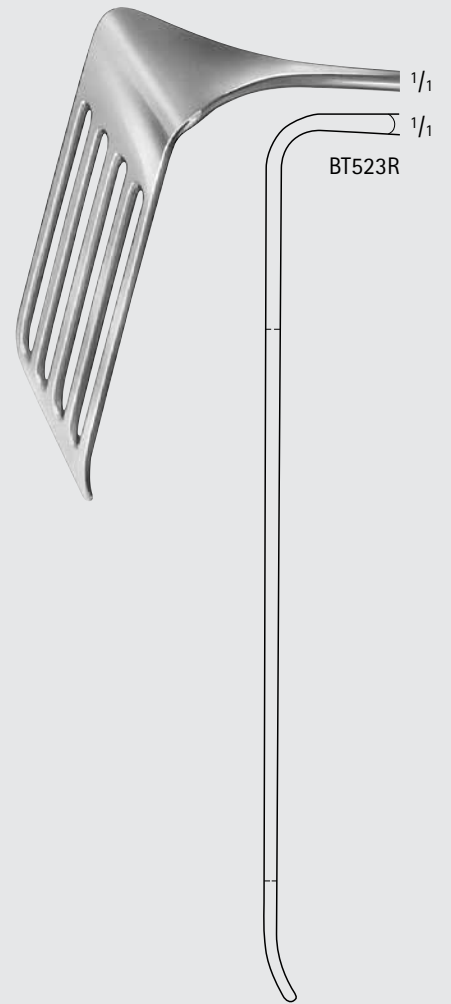
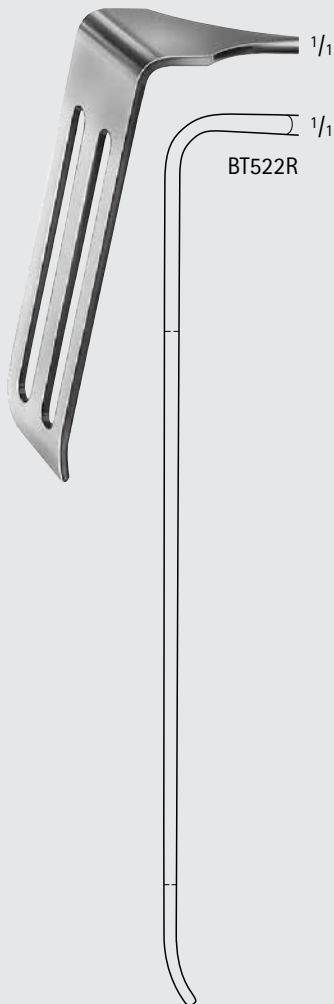

Cardiovascular Retractors

DAVIDSON Scapula Retractor

Catalog Number	Blade Size (mm)	Length (in.)
MB758R	80 x 50	7 3/4
BT531R	90 x 80	7 3/4

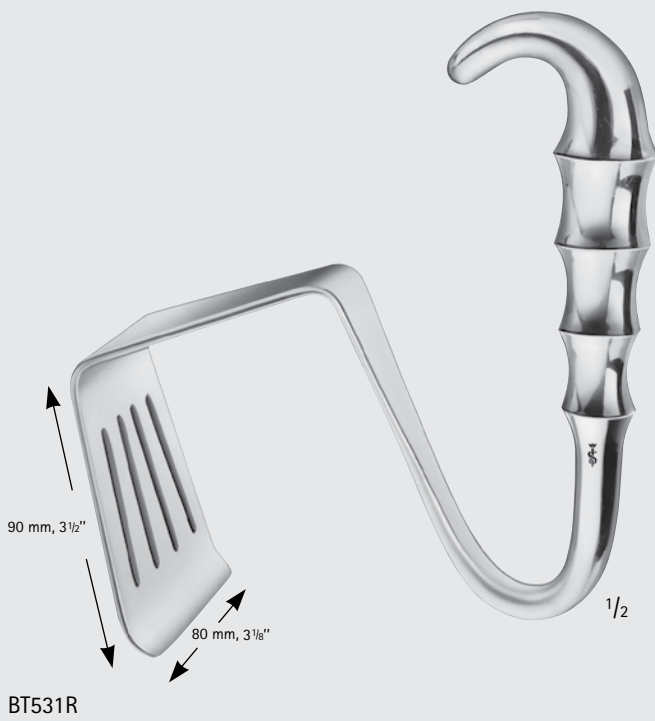
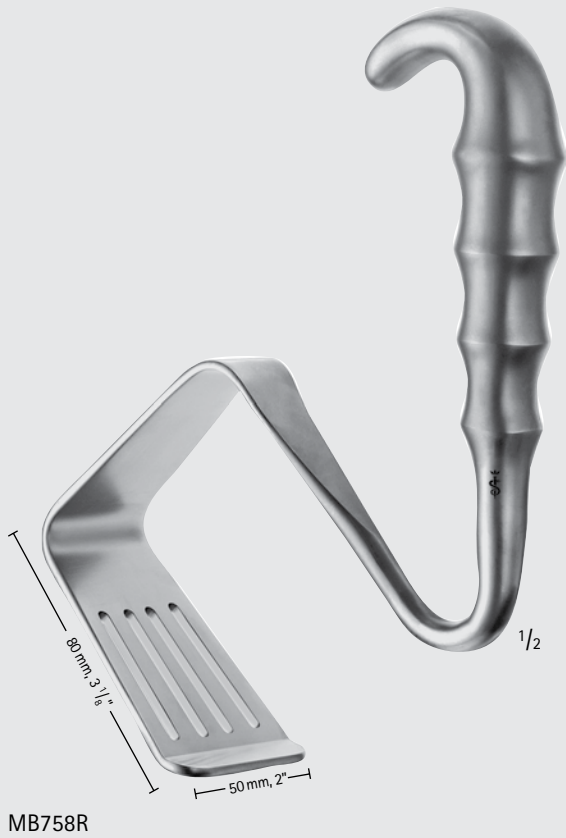

Cardiovascular

Retractors

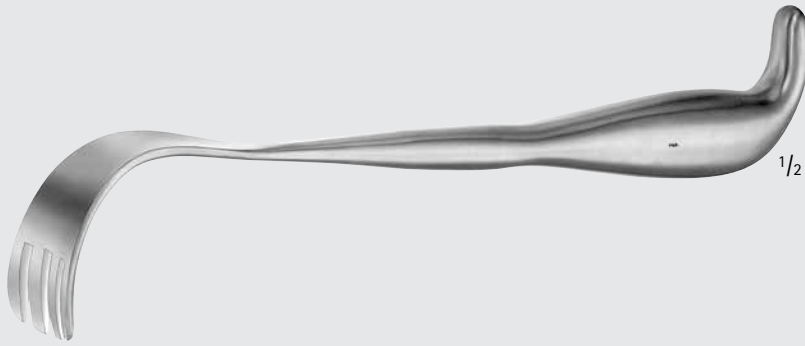

MB971R-MB972R

SEMB Lung Retractor

Catalog Number	Blade Size (mm)	Length (in.)
MB971R	29 x 19	9 1/4
MB972R	41 x 25	9 1/4

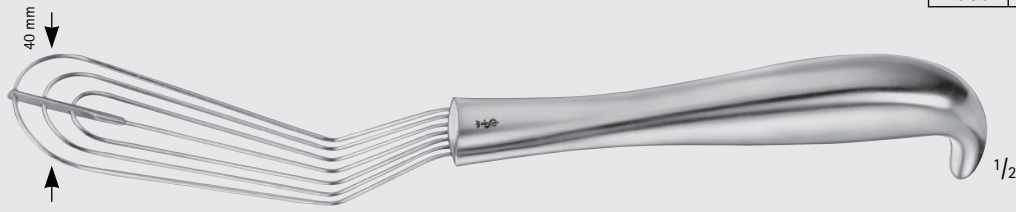

BT559R

ALLISON Lung Spatula

Catalog Number	Blade Size (mm)	Length (in.)
BT559R	40	10
BT560R	54	12 1/2

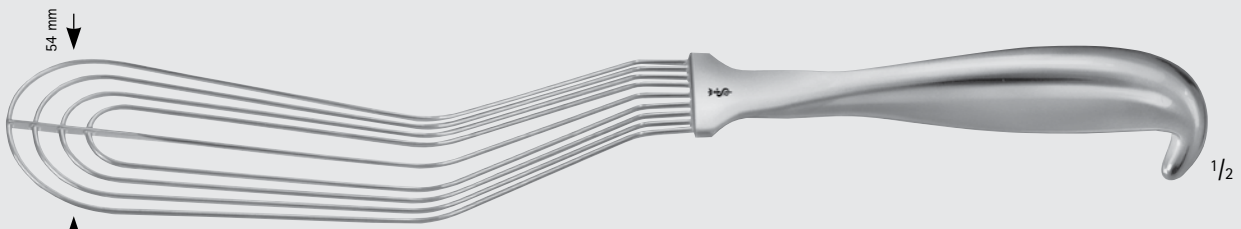

BT560R



Cardiovascular
Retractors

ALLISON "Sweetheart" Lung Spatula

Catalog Number	Blade Size (mm)	Length (in.)
BT561R	137	11 3/4

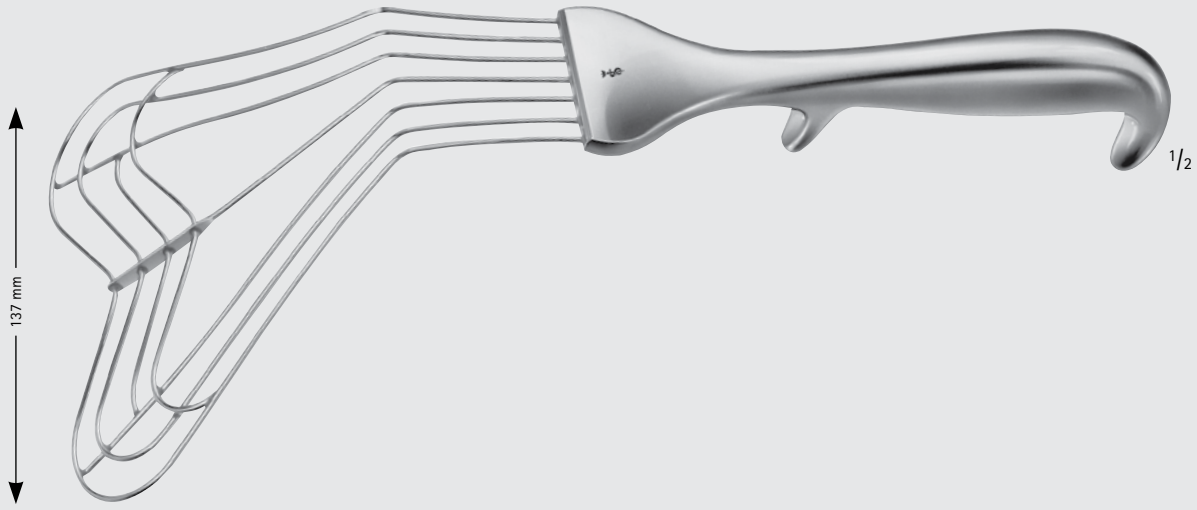

BT561R



Cardiovascular

Rib Spreaders

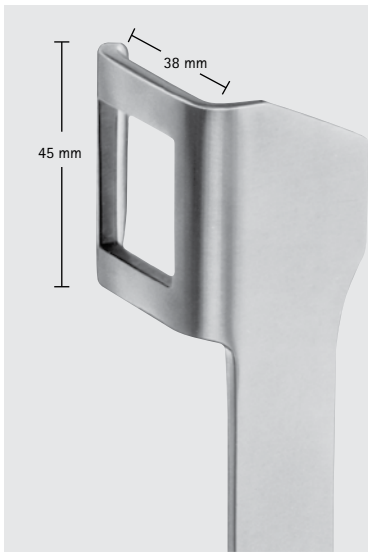

Dimensions for blade size of rib spreaders:
 1st number = Depth
 2nd number = Width
 Example: 38 x 45 mm

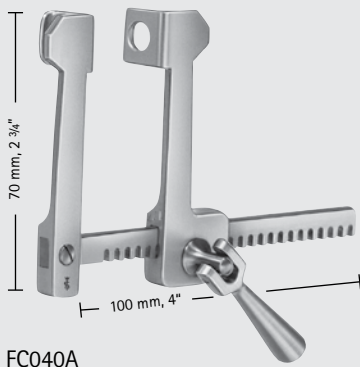

FC040A

FINOCHIETTO Rib Spreader, Aluminum

Catalog Number	Blade Size (mm)
FC040A	12 x 15

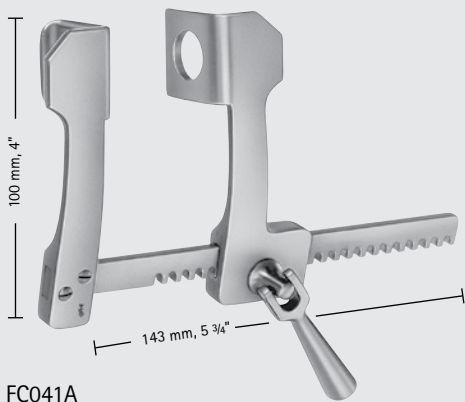

FC041A

FINOCHIETTO-HAIGHT Rib Spreader, Aluminum

Catalog Number	Blade Size (mm)
FC041A	28 x 30

Cardiovascular

Rib Spreaders

FINOCHIETTO Rib Spreader, Aluminum

Catalog Number	Blade Size (mm)
FC042A	31 x 45

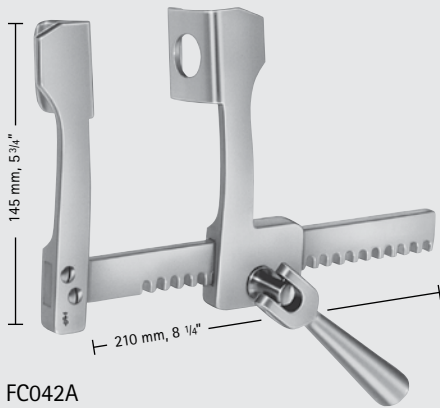

FC042A

FINOCHIETTO Rib Spreader, Aluminum

Catalog Number	Blade Size (mm)
FC043A	42 x 61

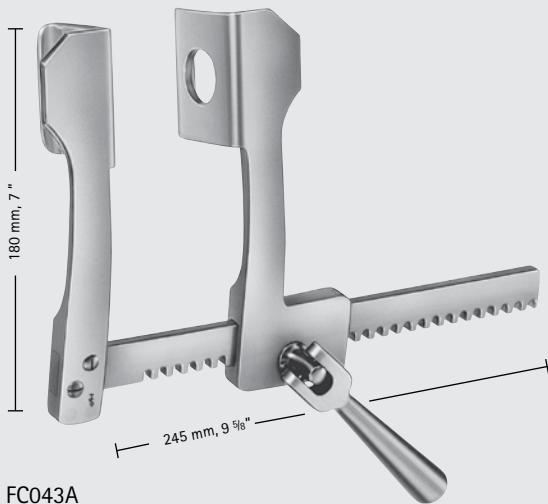

FC043A

FINOCHIETTO Rib Spreader, Aluminum

Catalog Number	Blade Size (mm)
FC044A	74 x 64

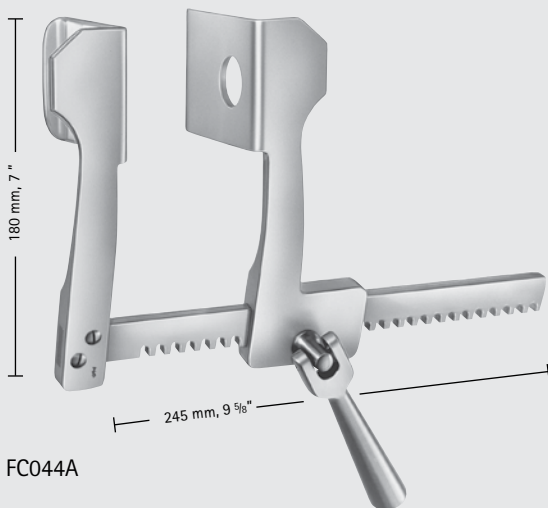

FC044A



Cardiovascular

Rib Spreaders

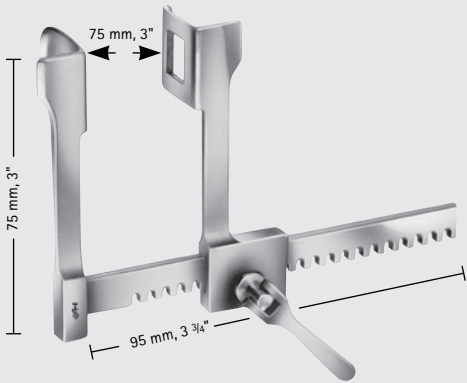

FB830R

FINOCHIETTO Rib Spreader, Infant

Catalog Number	Blade Size (mm)
FB830R	18 x 21

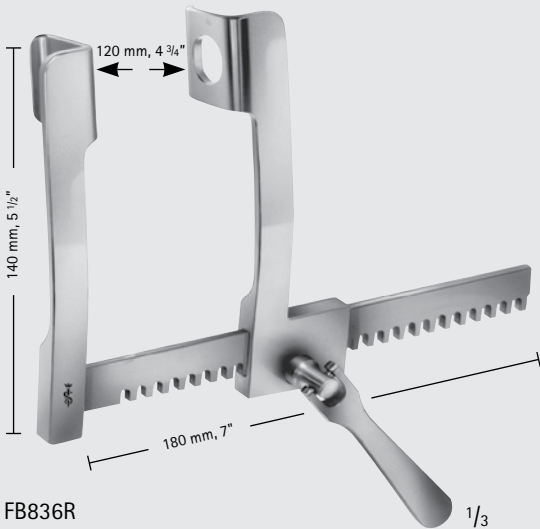

FB836R

FINOCHIETTO Rib Spreader, Pediatric

Catalog Number	Blade Size (mm)
FB836R	28 x 32

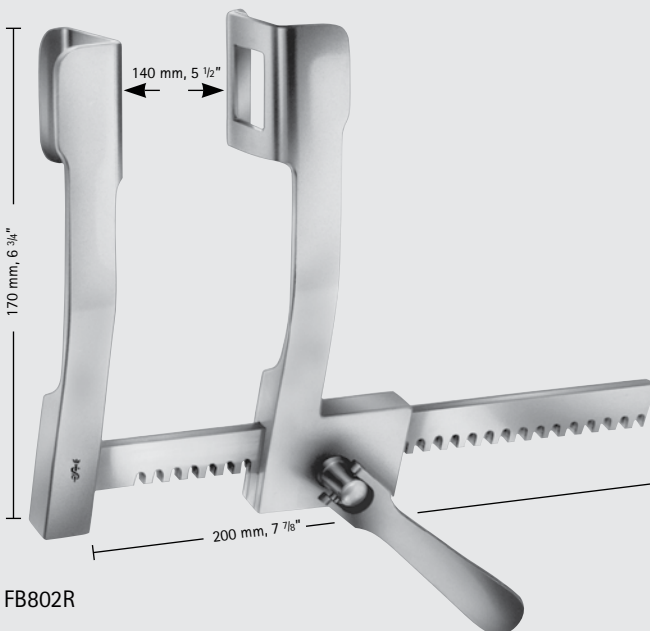

FB802R

FINOCHIETTO Rib Spreader, Small Adult

Catalog Number	Blade Size (mm)
FB802R	36 x 45

CARDIO
VASCULAR

Cardiovascular

Rib Spreaders

FINOCHIETTO Rib Spreader, Adult

Catalog Number	Blade Size (mm)
FB803R	44 x 65
FB804R	65 x 65

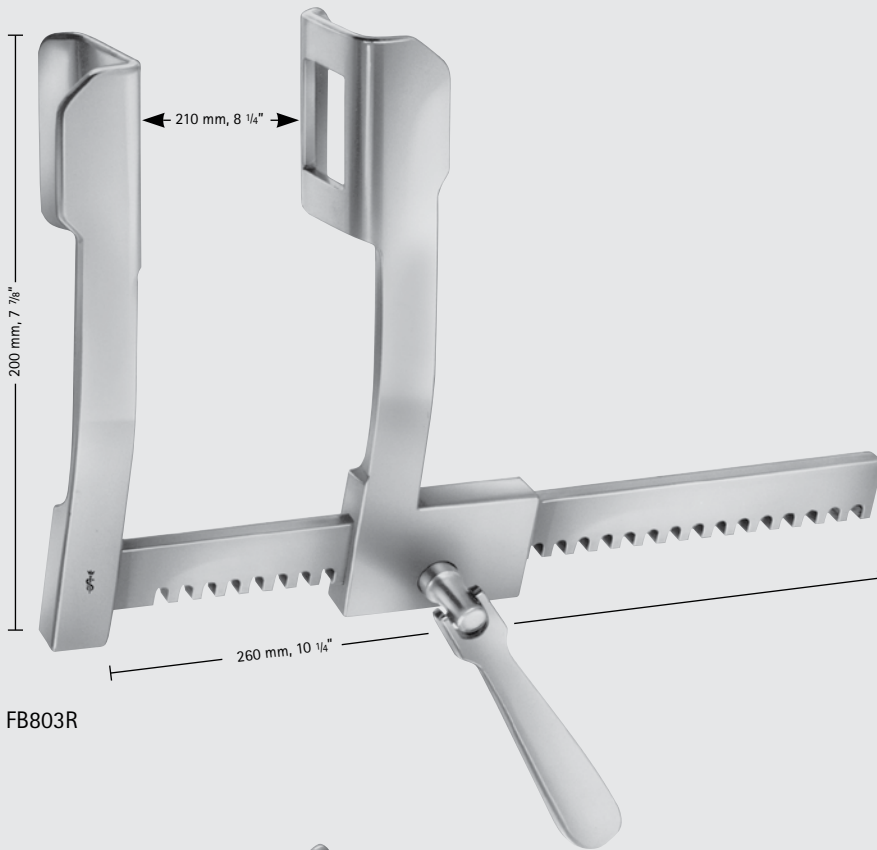

FB803R

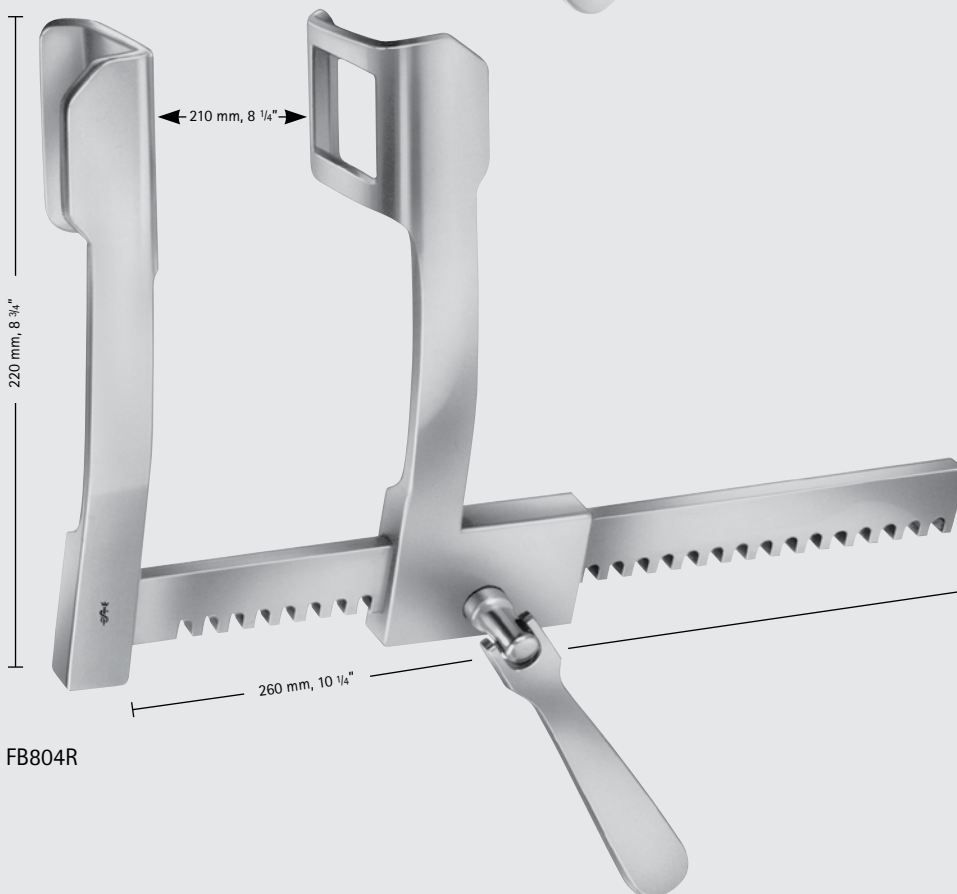

FB804R

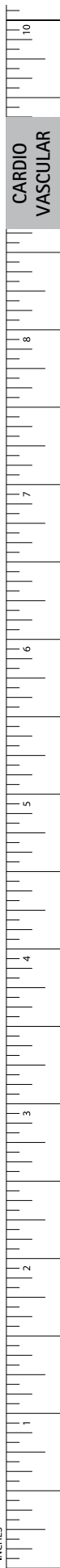

Cardiovascular

Rib Spreaders

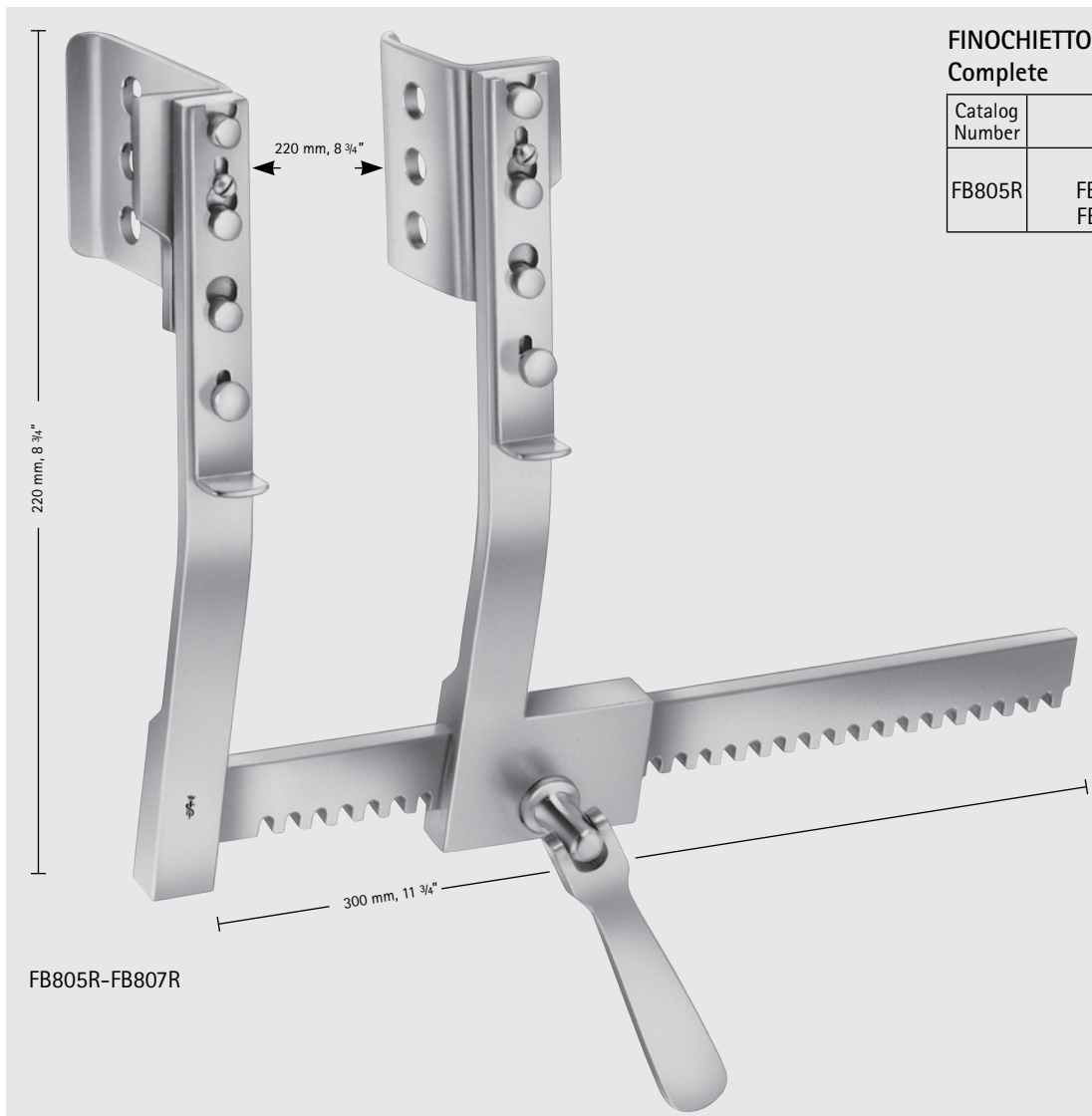
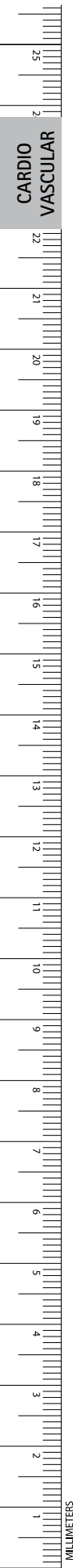

FB805R-FB807R

FINOCHIETTO-BURFORD Rib Spreader, Complete

Catalog Number	Description
FB805R	COMPLETE, W/ BLADES FB806R (45 MM x 64 MM) FB807R (75 MM x 64 MM)



FB806R

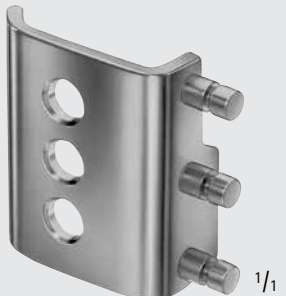

1/1



FB807R



1/1

Cardiovascular

Rib Spreaders

HAIGHT Rib Spreader

Catalog Number	Blade Size (mm)
FB835R	30 x 30

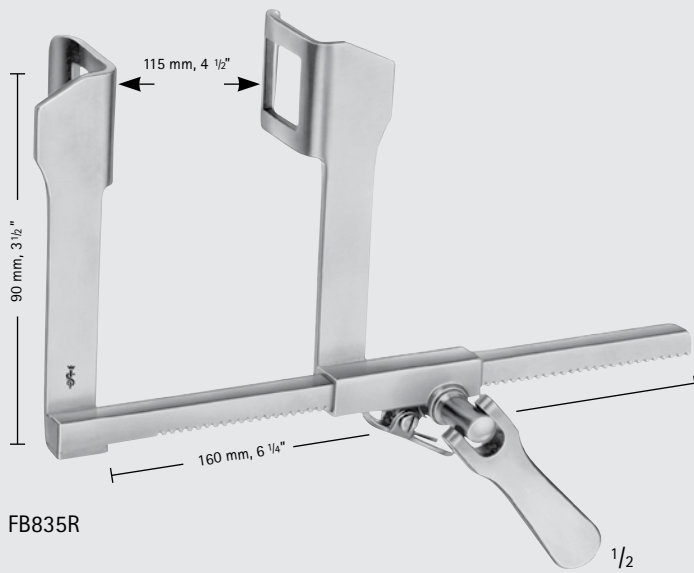

Rib Spreader, Premie

Catalog Number	Blade Size (mm)	Description
MG062R	7 x 7	SPREAD 1 1/2", ARM LENGTH 1 1/2"

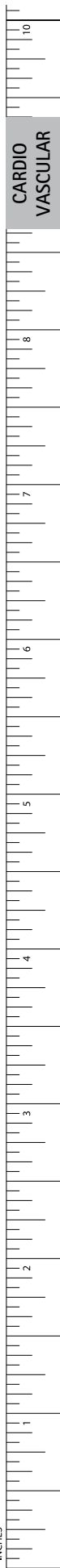
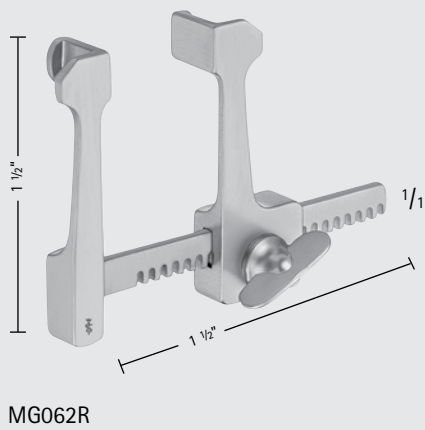

Cardiovascular

Rib Spreaders

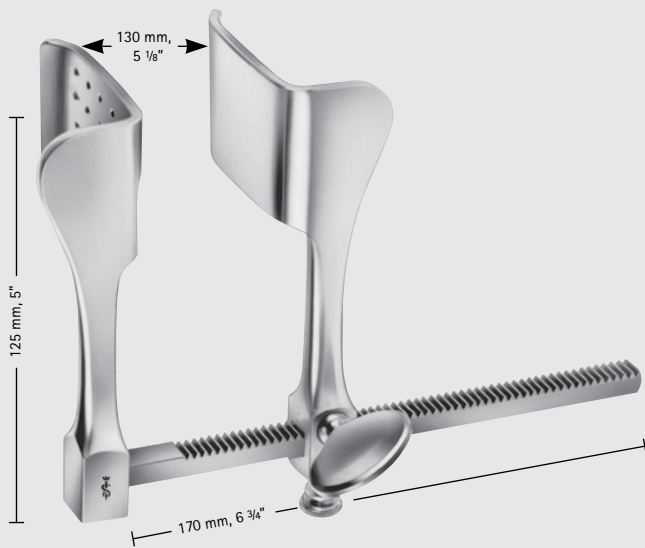
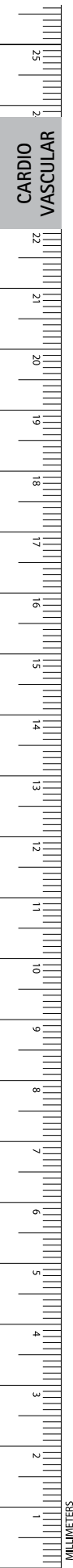

FB800R

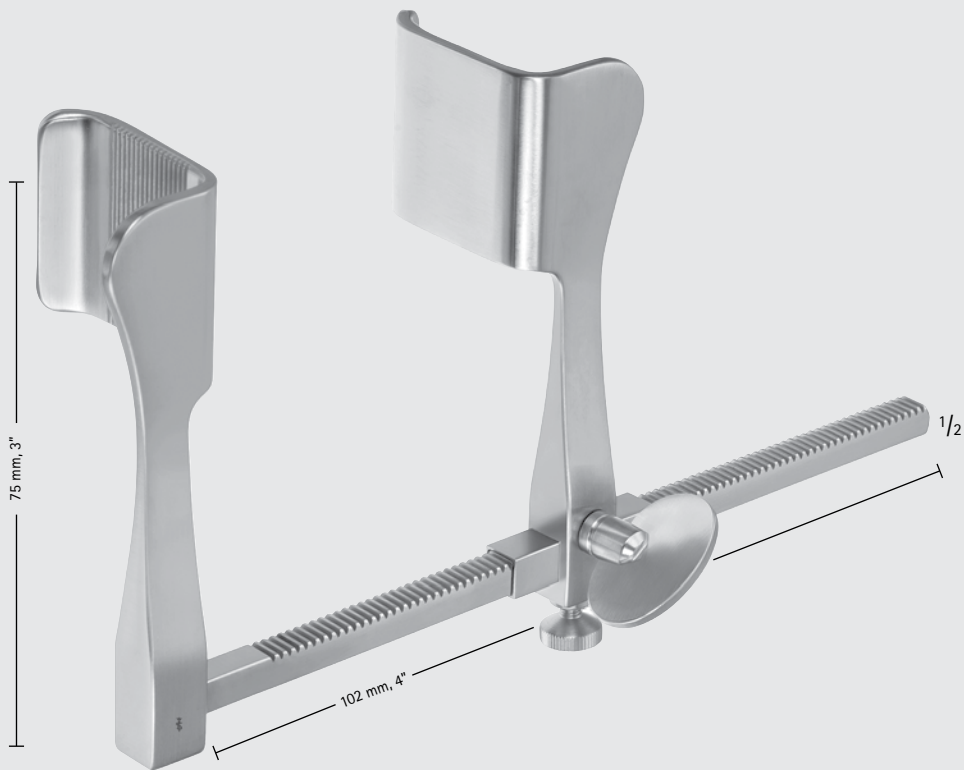

MG061R

TUFFIER Rib Spreader

Catalog Number	Blade Size (mm)	Blade End
FB800R	43 x 53	RIBBED
MG061R	45 x 47	SERR

BAILEY Rib Contractor

Catalog Number	Description	Length (in.)
FB844R	PEDIATRIC	6
FB841R	SMALL ADULT	7 7/8
FB842R	ADULT	7 7/8



FB844R

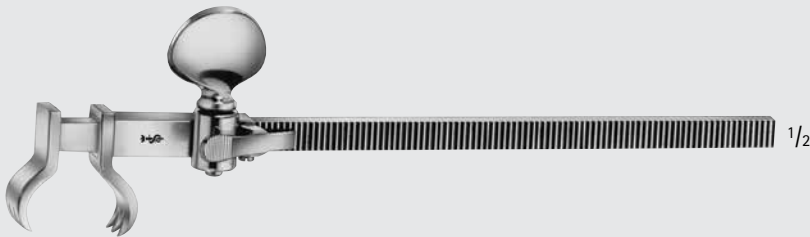
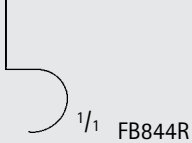

FB841R-FB842R



FB841R



FB841R



FB842R

FAVALORO-MORSE Sternal Retractor

Catalog Number	Blade Size (mm)
MG015R	40 x 29

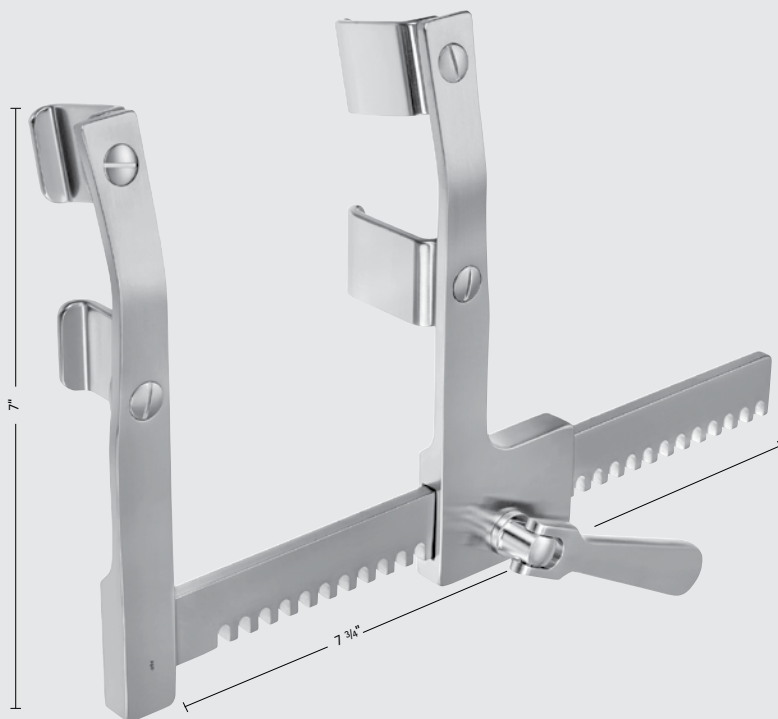

MG015R



Cardiovascular

Rib Spreaders

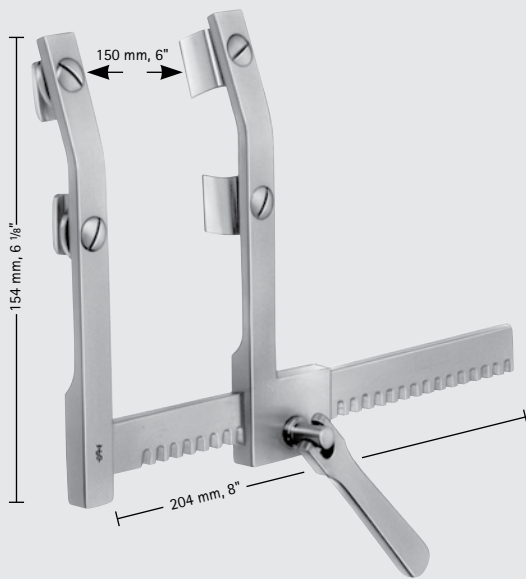

FB845R

MORSE Sternotomy Retractor, Pediatric

Catalog Number	Blade Size (mm)
FB845R	12 x 20

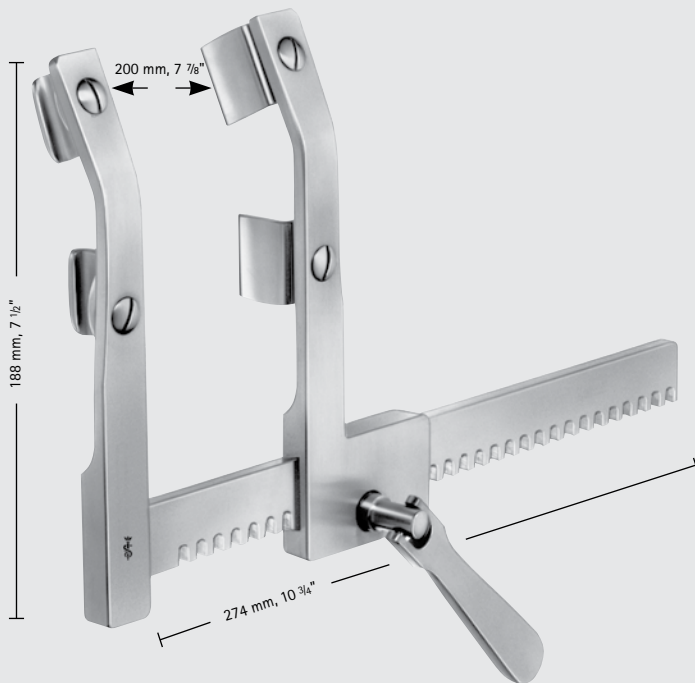

FB846R

MORSE Sternotomy Retractor, Adult

Catalog Number	Blade Size (mm)
FB846R	19 x 29

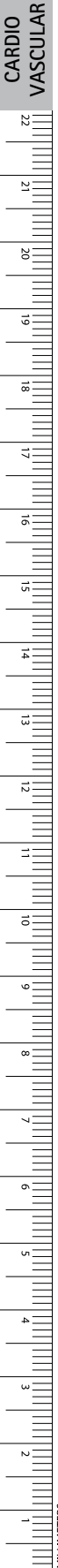

Cardiovascular Rib Spreaders

REINHOFF Rib Spreader

Catalog Number	Blade Size (mm)
MG063R	45 x 50

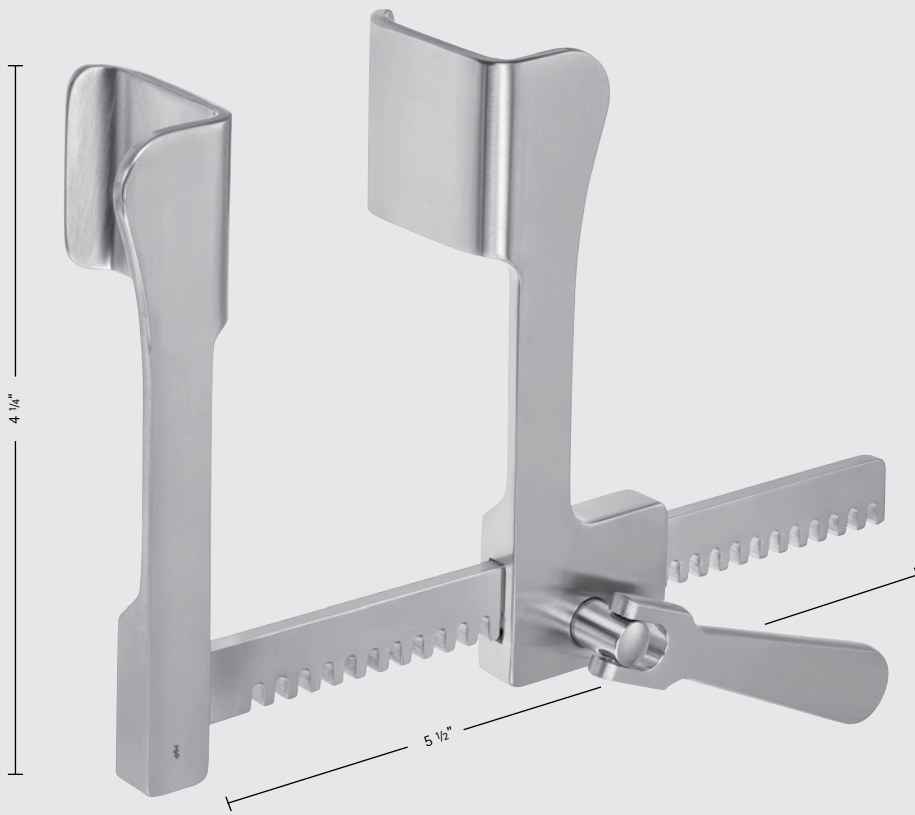

MG063R



Cardiovascular

Rib Spreaders

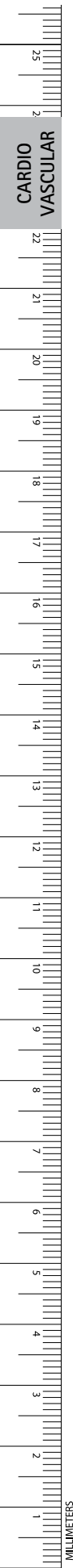

CARDIO
VASCULAR

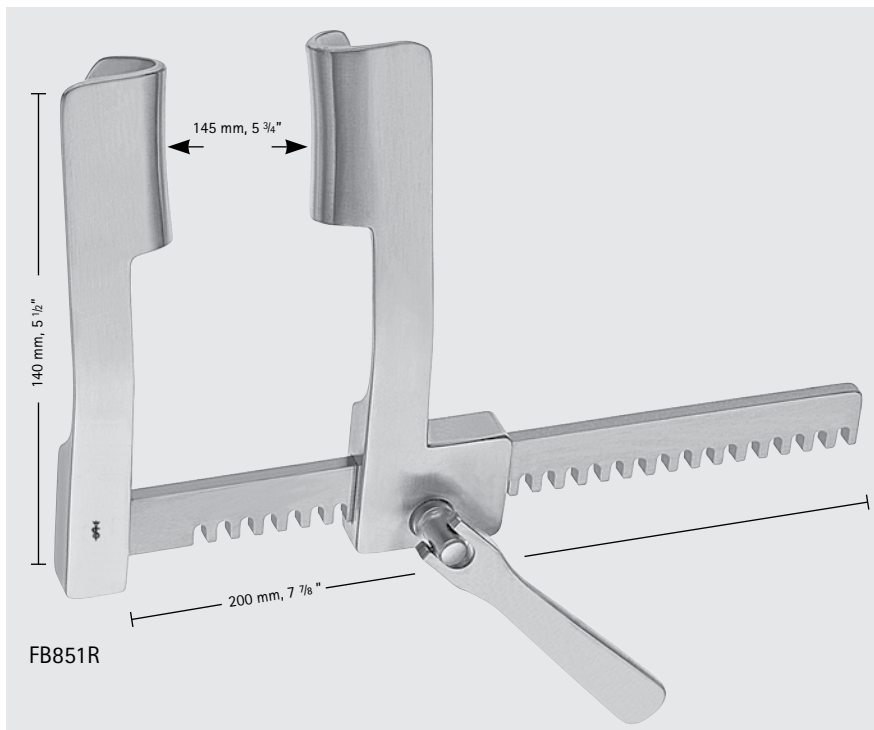

FB851R

COOLEY Sternotomy Spreader, Pediatric

Catalog Number	Blade Size (mm)
FB851R	21 x 45



FB851R

Cardiovascular

Rib Spreaders

COOLEY Sternotomy Spreader, Adult

Catalog Number	Blade Size (mm)
FB850R	32 x 50

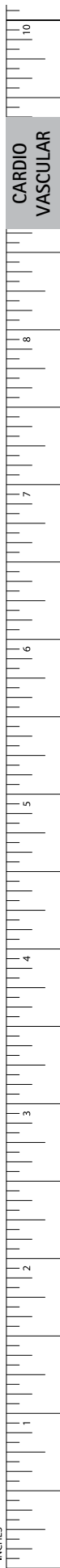
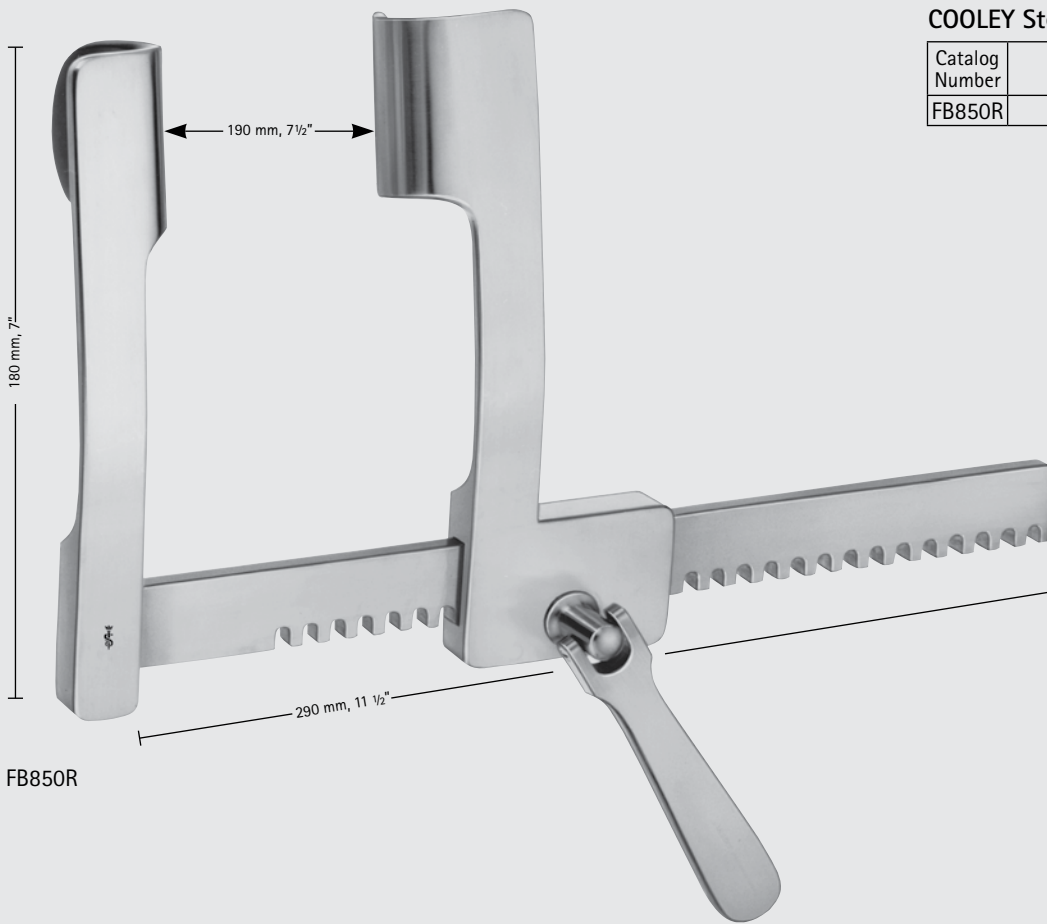

Cardiovascular

Rib Spreaders

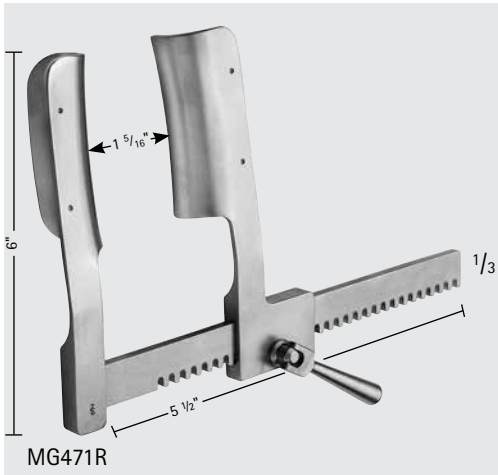

COOLEY Sternotomy Spreader, Extra Large

Catalog Number	Blade Size (mm)
MG471R	35 x 100



COOLEY Sternal Retractor, Aluminum, Pediatric

Catalog Number	Blade Size (mm)
MG016R	17 x 19 W/ PINS

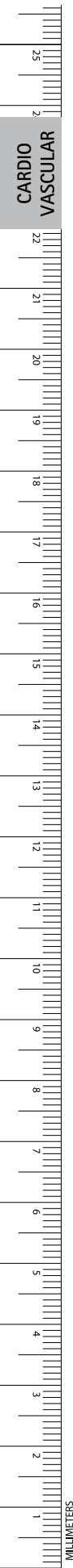
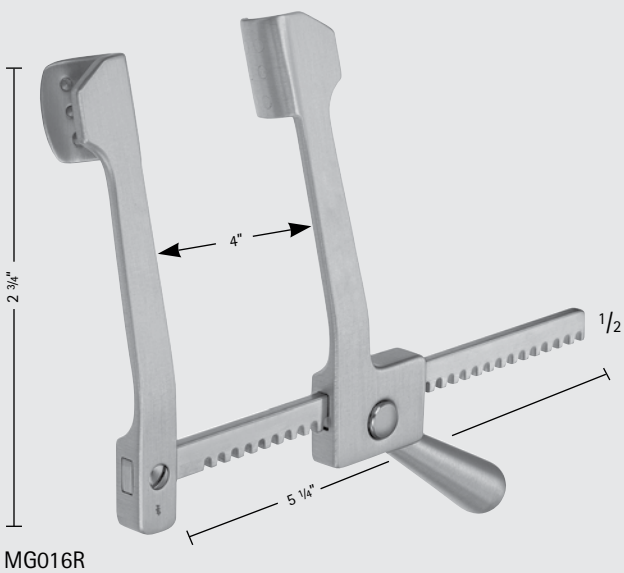

Sternal Retractor

Catalog Number	Blade Size (mm)	Description
MG017R	12 x 10	DOUBLE BLADES 12 x 10 MM
MG018R	14 x 14	DOUBLE BLADE 14 x 14 MM
MG019R	20 x 19	DOUBLE BLADE 20 x 19 MM

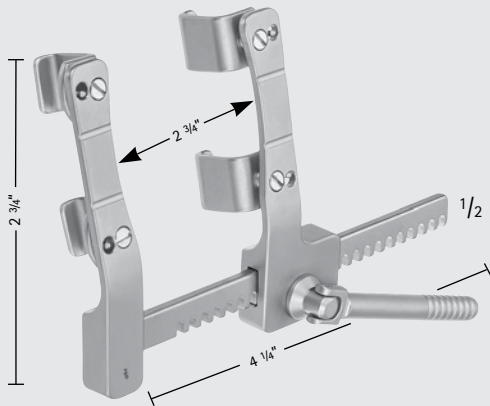

MG017R

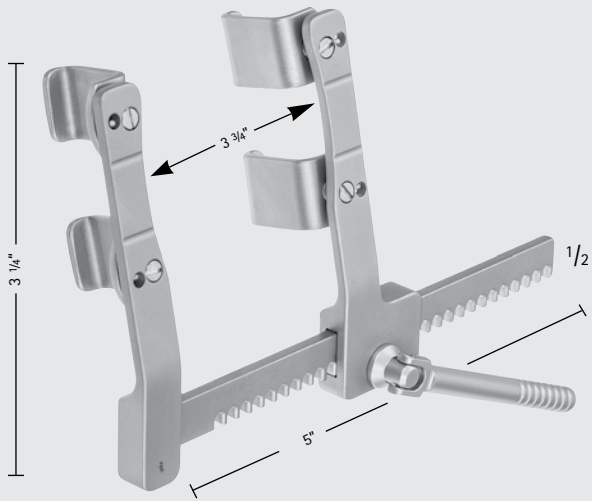

MG018R

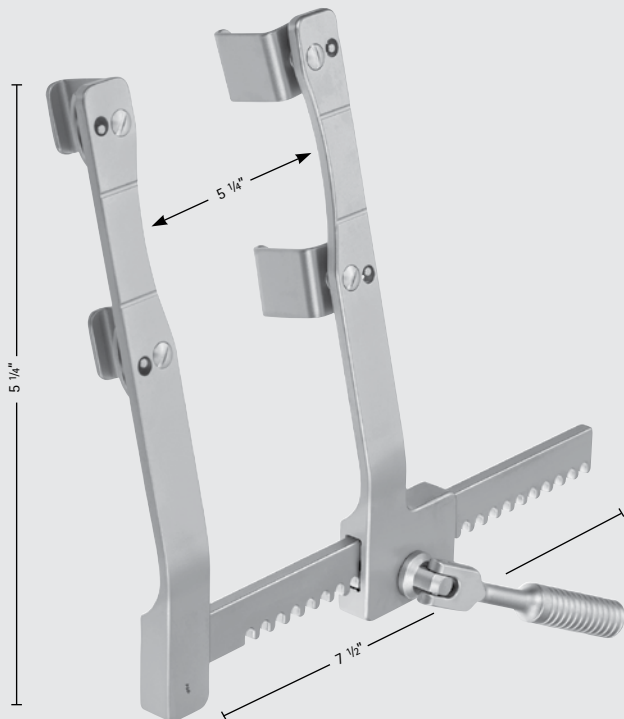

MG019R

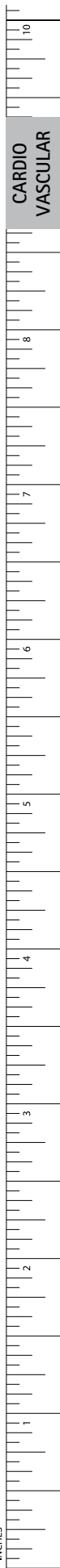

Cardiovascular

Rib Spreaders

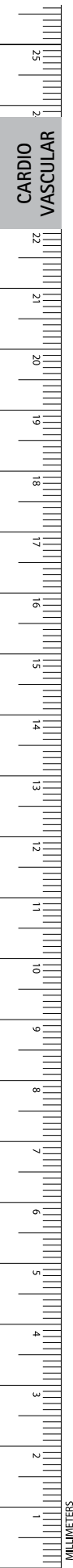

CHAUX Sternal Retractor

Catalog Number	Blade Size (mm)	Description
MG020R	27 x 30	ROTATION FOR IMA EXPOSURE

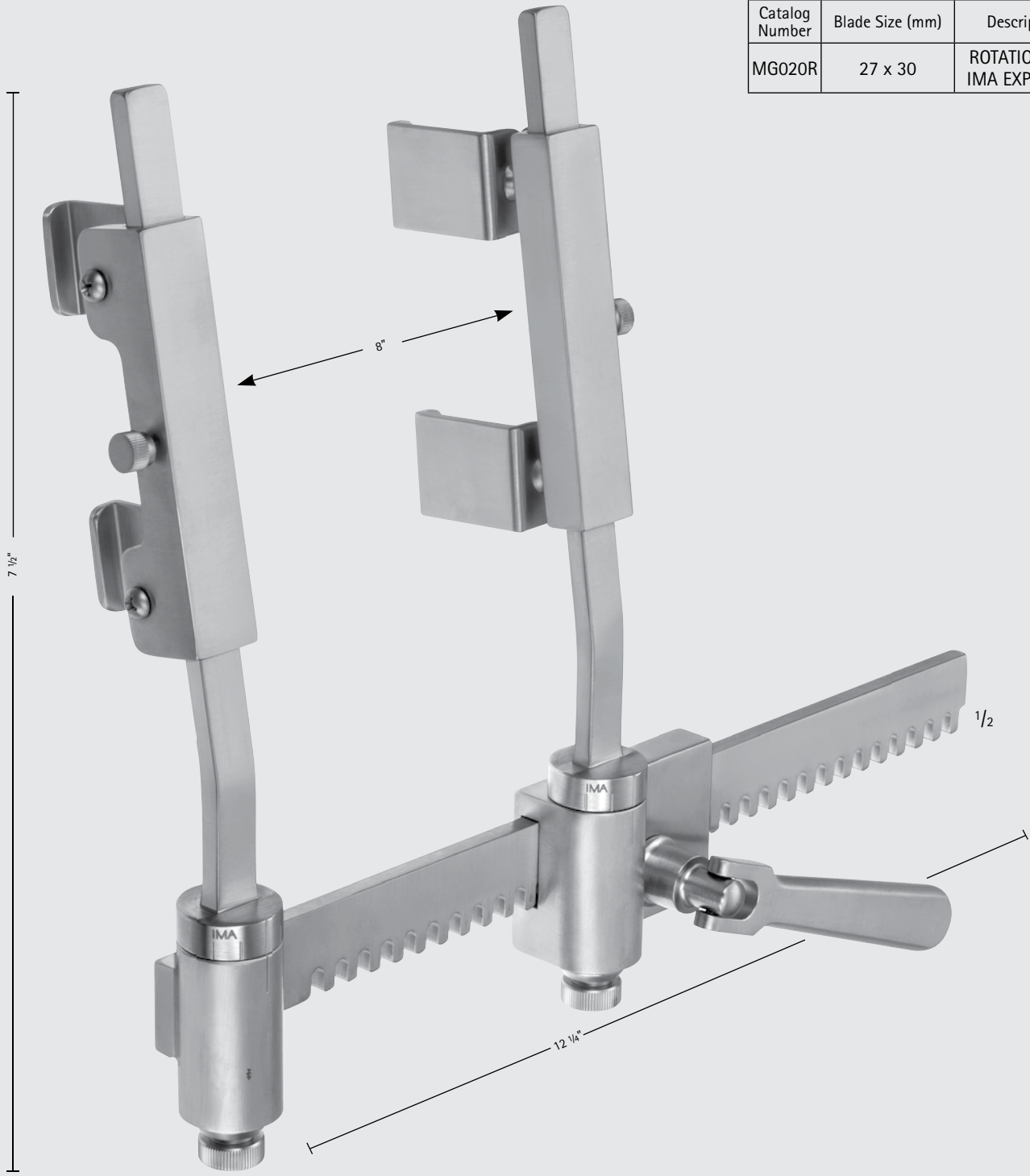

MG020R

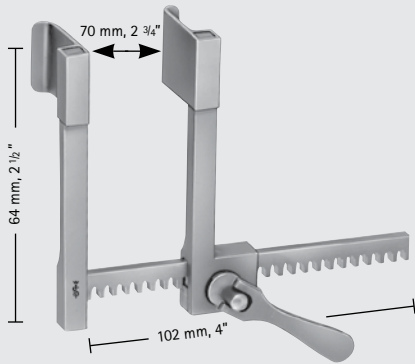

FB852R

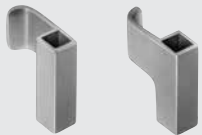

FB854R



FB855R



FB856R



FB857R



FB858R

STRUCK Rib Spreader, Infant

Catalog Number	Description
FB852R	COMPLETE
FB853R	SPREADER ONLY, 64 x 92 MM
FB854R	OPT. BLADES, 10 x 10 MM, 2/SET
FB855R	OPT. BLADES, 10 x 15 MM, 2/SET
FB856R	OPT. BLADES, 10 x 20 MM, 2/SET
FB857R	BLADES, 15 x 20 MM, 2/SET
FB858R	BLADES, 20 x 20 MM, 2/SET

FB852R Includes:
 FB853R Spreader only
 FB857R Blades (pair)
 FB858R Blades (pair)

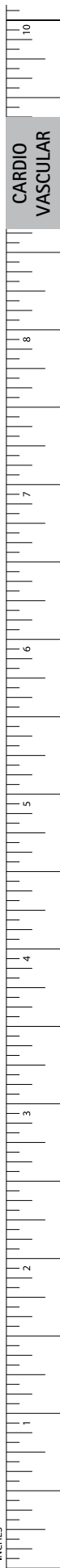

INCHES

Cardiovascular

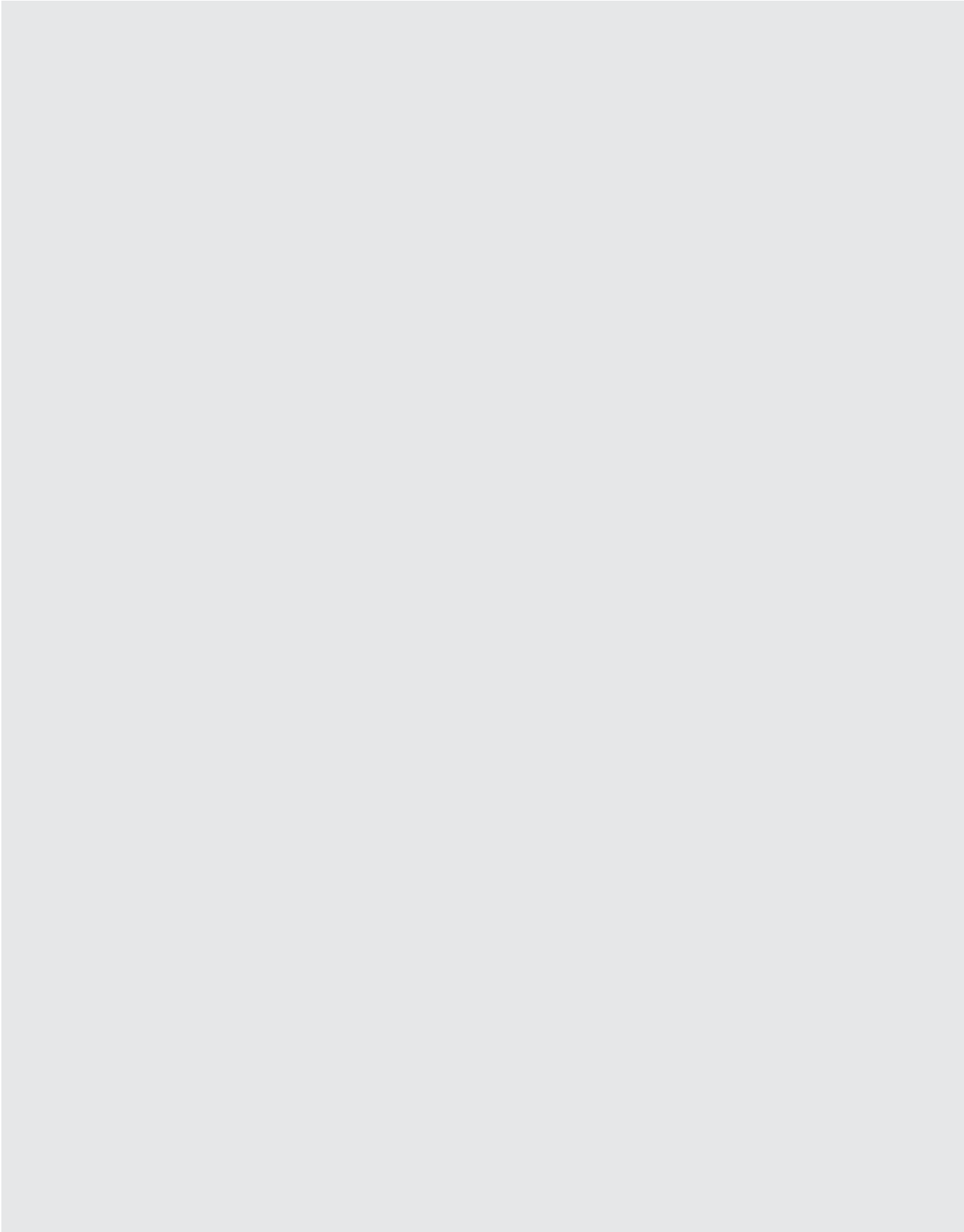
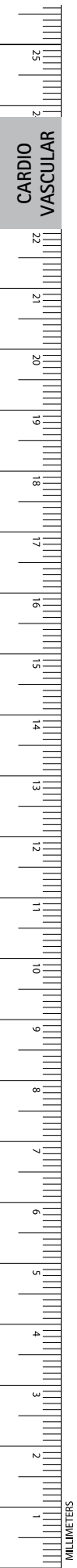



ENT-EAR

Scissors	536
Needles	537 - 538
Tissue, Dressing and Sponge Forceps	539 - 542
Alligator Forceps	543 - 549
Nippers, Crimping Forceps and Snares	550 - 553
Hooks and Probes	554 - 555
Retractors	556 - 557
Picks	558 - 561
Specula	562 - 567
Cotton Applicators	568
Knives	569 - 575
Suction Irrigation	576 - 579
Dissectors, Chisels and Gouges	580 - 581
Elevators, Scrapers and Excavators	582 - 583
Augers, Measurers and Rasps	584
Curettes, Loops and Spoons	585 - 589
Rongeurs	590
Tuning Forks	591
Miscellaneous	592 - 593

ENT-EAR

Scissors

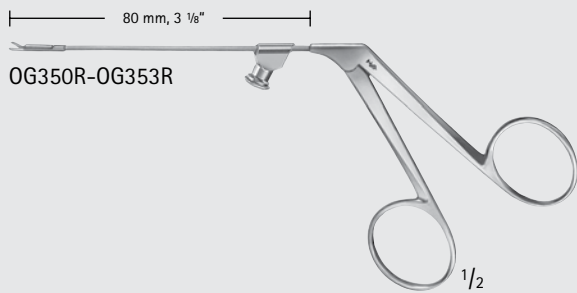

BELLUCCI Micro Scissors

Catalog Number	Tip	Blade	Working Length (in.)	Length (in.)
OG350R	S/S	STR	3 1/8	5 1/4
OG352R	S/S	CVD-LEFT	3 1/8	5 1/4
OG353R	S/S	CVD-RIGHT	3 1/8	5 1/4
OG351R	B/B	ANG-UP	3 1/8	5 1/4

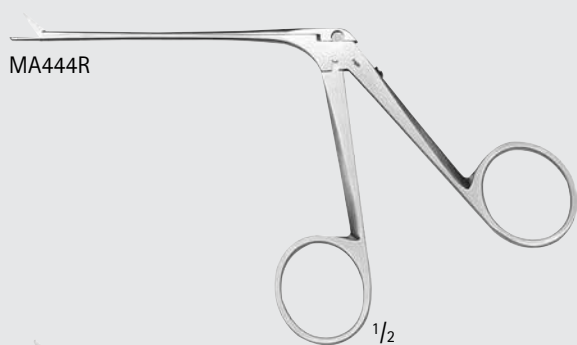

BELLUCCI Scissors

Catalog Number	Tip	Blade	Blade Size (mm)	Working Length (in.)	Length (in.)
MA444R	B/B	STR	7	3	5 1/4
OG355R	S/S	CVD-UP	-	3 1/8	5 1/4

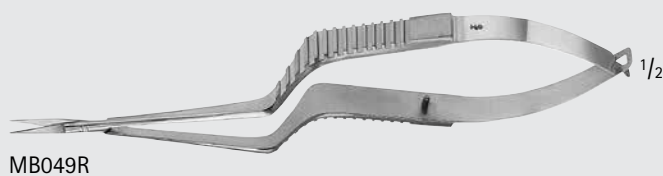
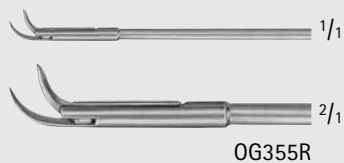
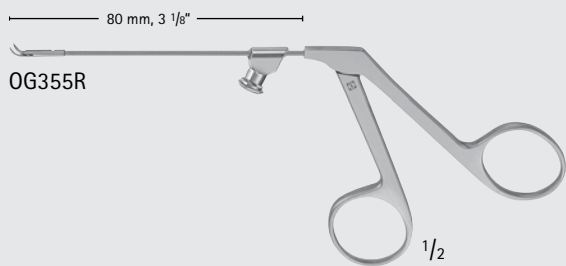
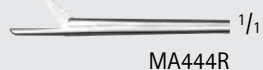

WIET Ear Scissors, Bayonet-Shaped

Catalog Number	Tip	Blade	Length (in.)
MB049R	S/S	STR	6 1/2

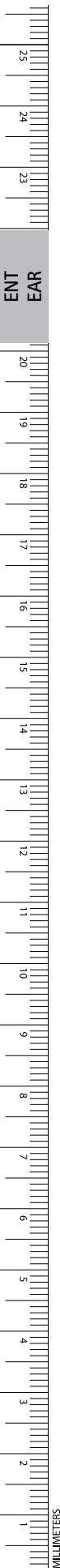

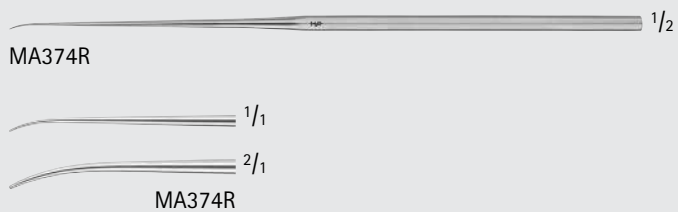
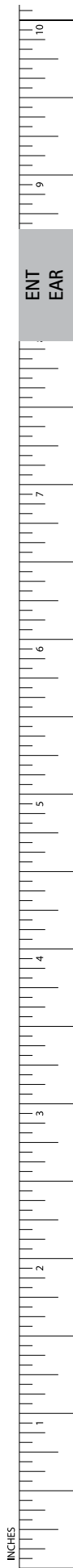

HOUSE Needle

Catalog Number	Tip	Blade Shape	Length (in.)
MA374R	DEL	CVD	6 1/2

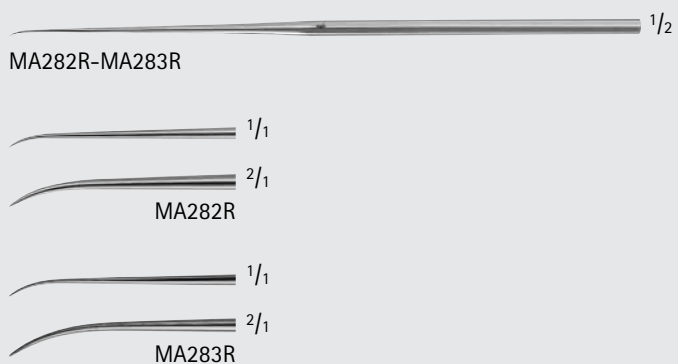

HOUSE Needle, Malleable

Catalog Number	Tip	Blade Angle	Length (in.)
MA282R	SEMI-SHARP	CVD	6 1/2
MA283R	W/ ROSEN POINT, SEMI-SHARP	CVD	6 1/2

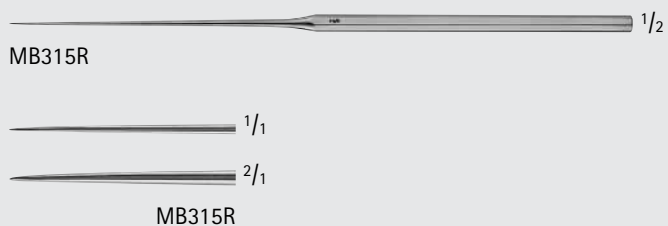

HOUSE-BARBARA Needle

Catalog Number	Tip	Blade Angle	Length (in.)
MB315R	SHARP	STR	6 1/2

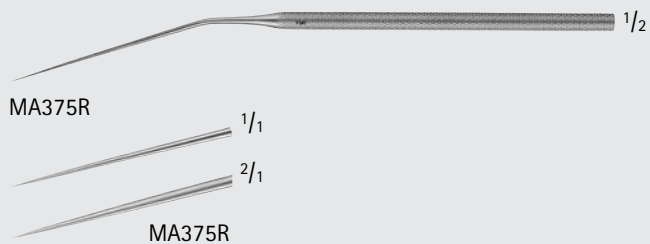

MCGEE Perforating Needle

Catalog Number	Tip	Blade Angle	Length (in.)
MA375R	SHARP	ANG 20°	6 3/8

ENT-EAR

Needles



OG001R

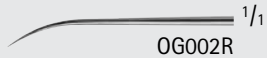

OG002R

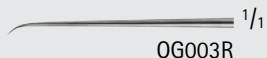

OG003R

Micro Needles

Catalog Number	Tip	Blade Angle	Length (in.)
OG001R	SHARP-POINT	STR	6 1/4
OG002R	SHARP-POINT	CVD	6 1/4
OG003R	SHARP-POINT	HEAVY-CVD	6 1/4

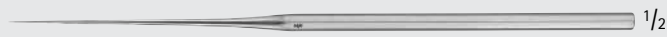

MA376R



1/1



2/1

MA376R

PAPARELLA Needle, Malleable, Heavy

Catalog Number	Tip Size (#)	Blade Angle	Working Length (in.)	Length (in.)
MA376R	6	STR	2 3/4	6 1/2



MA377R

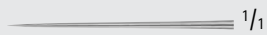

1/1



2/1

MA377R

SAUNDERS-PAPARELLA Needle, Malleable, Fine

Catalog Number	Tip Size (#)	Blade Angle	Working Length (in.)	Length (in.)
MA377R	5	STR	2 3/4	6 1/2



MA378R



1/1
MA378R

WRIGHT Fascia Needle

Catalog Number	Tip	Tip Size (mm)	Length (in.)
MA378R	CVD	2	5 1/8





MA550R



MA550R

SHEEHY Ossicle Holding Forceps

Catalog Number	Length (in.)
MA550R	4 3/4

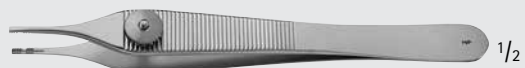

MA703R



MA703R

DERLACKI Ossicle Holding Forceps

Catalog Number	Tip	Length (in.)
MA703R	1 MM TEETH W/ VERTICAL AND HORIZONTAL GROOVE	5



OF405R



OF405R



OF403R



OF403R

HARTMANN Tampon Forceps

Catalog Number	Tip	Length (in.)
OF405R	HEAVY	5
OF403R	DELICATE	5 1/4

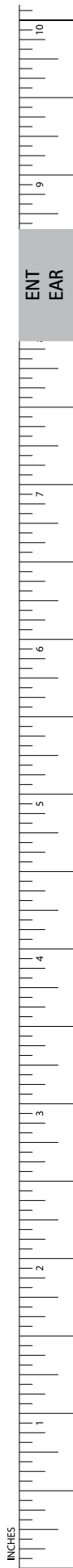

INCHES

ENT-EAR

Tissue/Dressing/Sponge Forceps

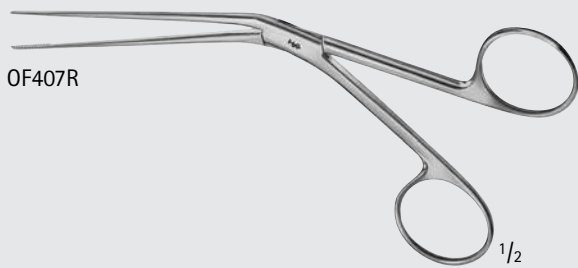

TILLEY Ear Tampon Forceps

Catalog Number	Tip	Length (in.)
OF407R	X-DEL	5 1/2

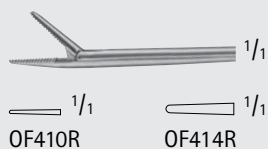
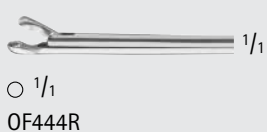
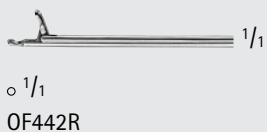
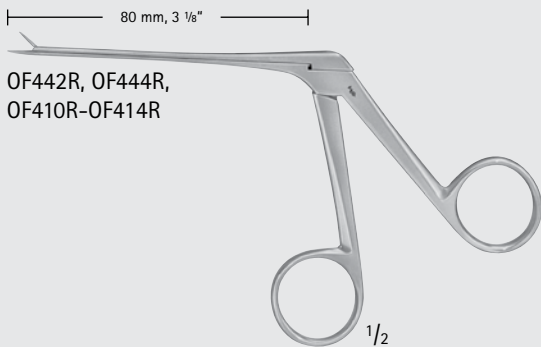

HARTMANN-WULLSTEIN Ear Forceps

Catalog Number	Tip Size (mm)	Jaw	Working Length (in.)
OF442R	1	STR, CUP	3 1/8
OF444R	2	STR, CUP	3 1/8
OF410R	0.5 x 6	STR, SERR	3 1/8
OF414R	1 x 8	STR, SERR	3 1/8

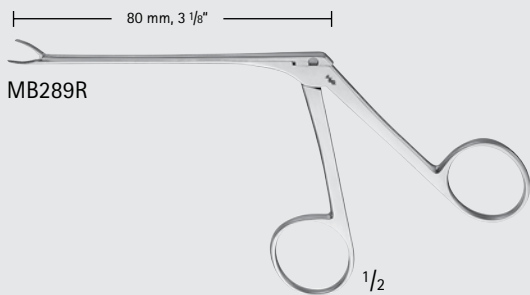

WEINGARTNER Ear Forceps

Catalog Number	Jaw	Working Length (in.)
MB289R	SERR	3 1/8

ENT
EAR

MILLIMETERS

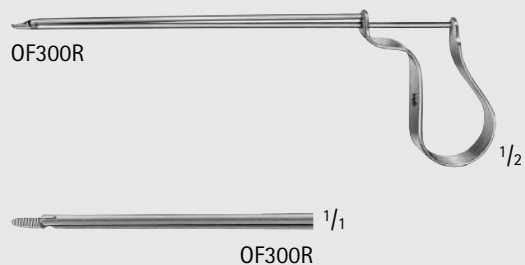

QUIRE Foreign Body Forceps

Catalog Number	Working Length (in.)	Length (in.)
OF300R	3 1/2	4 3/4

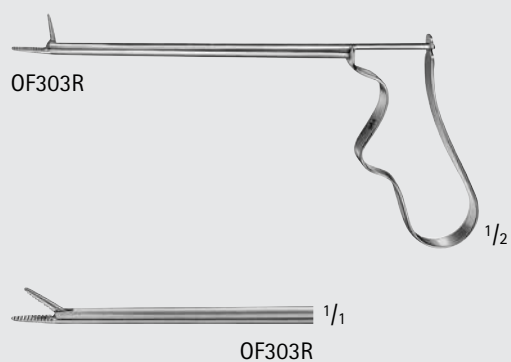

BUCK Alligator Forceps

Catalog Number	Working Length (in.)	Length (in.)
OF303R	1 7/8	3 1/2

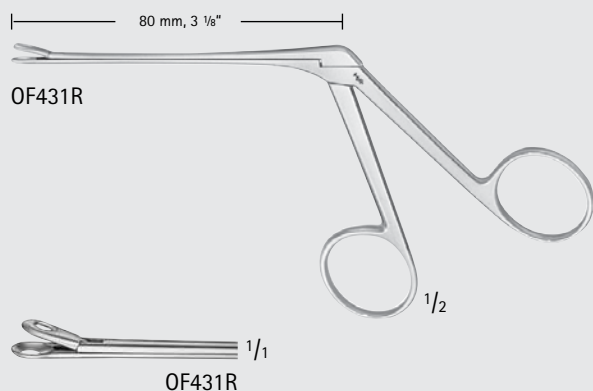

HENCKEL Spoon Forceps

Catalog Number	Tip Size (mm)	Jaw	Working Length (in.)
OF431R	3 x 5	FLAT, OVAL SPOON	3 1/8

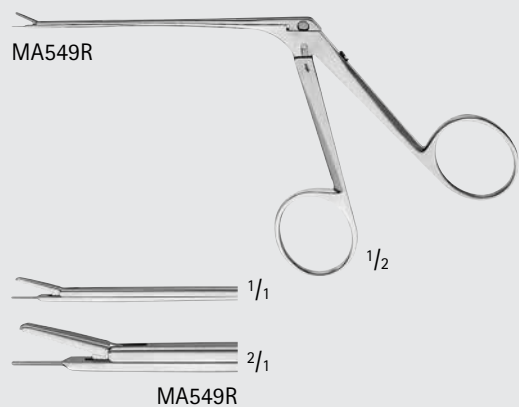

LEIVERS Vent Tube Introducer Forceps

Catalog Number	Working Length (in.)	Length (in.)
MA549R	2 7/8	5 3/8

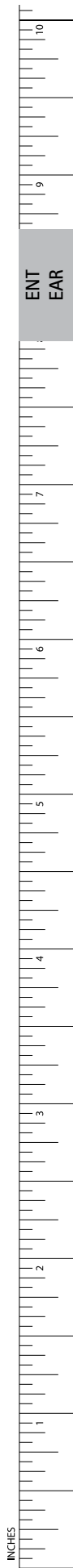

ENT-EAR

Tissue/Dressing/Sponge Forceps

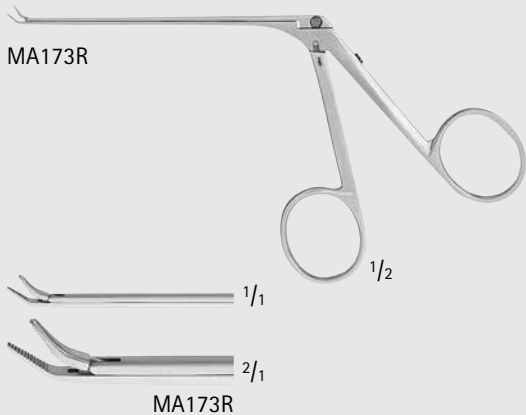
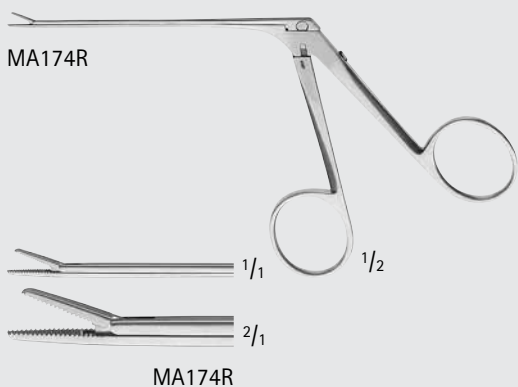
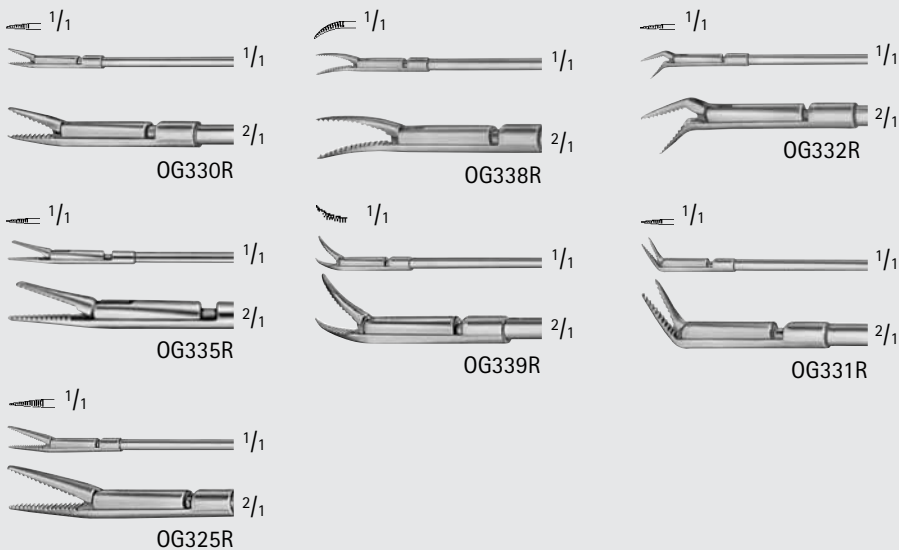
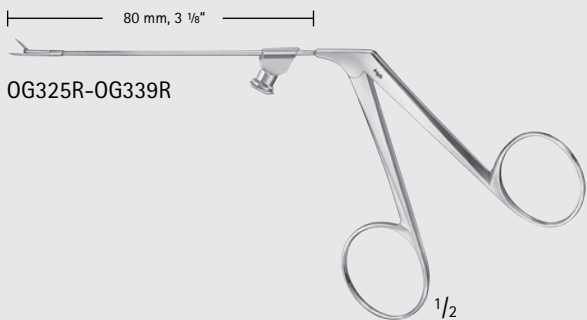
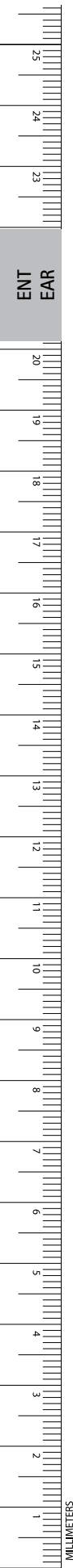

Alligator Forceps, Serrated

Catalog Number	Tip Size (mm)	Jaw	Working Length (in.)
OG330R	0.8 x 3.5	STR	3 1/8
OG335R	1 x 5	STR	3 1/8
OG325R	1.5 x 6.0	STR	3 1/8
MA174R	4	STR	3 1/8
OG338R	1 x 5	CVD-LEFT	3 1/8
OG339R	1 x 5	CVD-RIGHT	3 1/8
OG332R	0.8 x 3.5	ANG-DOWN 45°	3 1/8
OG331R	0.8 x 3.5	ANG-UP 55°	3 1/8
MA173R	4	ANG-UP	3

ENT-EAR

Alligator Forceps

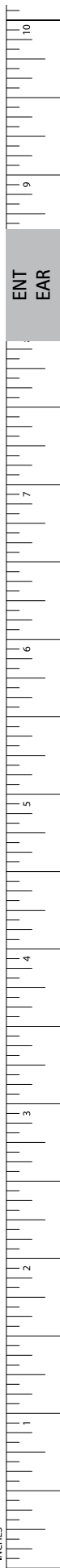

MA159R

MA159R

BELLUCCI Alligator Ear Forceps

Catalog Number	Tip Size (mm)	Jaw	Working Length (in.)
MA159R	8	STR, SERR	3 1/4

MA659R

MA659R

Alligator Ear Forceps, Ebony

Catalog Number	Tip Size (mm)	Jaw	Working Length (in.)
MA659R	0.8 x 4.5	STR, SERR	3

OF411R, OF420R

80 mm, 3 1/8"

OF411R

OF420R

HARTMANN Ear Forceps

Catalog Number	Tip Size (mm)	Jaw	Working Length (in.)
OF411R	1 x 8	STR, SERR	3 1/8
OF420R	1 x 8	STR, 1 x 2 TEETH	3 1/8

ENT-EAR

Alligator Forceps

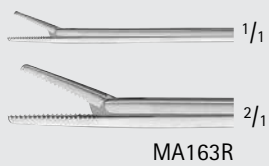
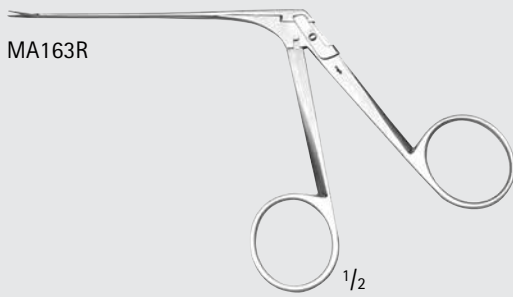

HOUSE Alligator Ear Forceps, Horizontal Opening

Catalog Number	Tip Size (mm)	Jaw	Working Length (in.)
MA163R	6	SERR	3 1/8

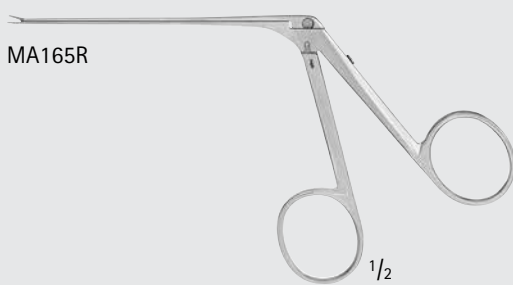

HOUSE Miniature Alligator Ear Forceps, Delicate

Catalog Number	Tip Size (mm)	Jaw	Working Length (in.)
MA165R	4	SERR	3 1/8

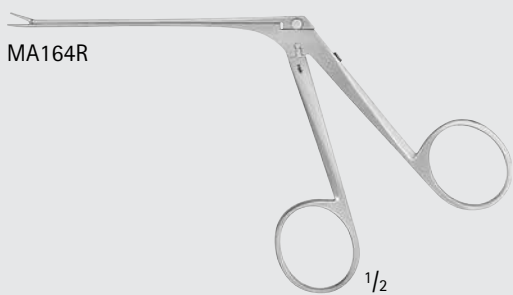

HOUSE Strut Forceps

Catalog Number	Tip Size (mm)	Jaw	Working Length (in.)
MA164R	6	STR, SMOOTH	3 1/8

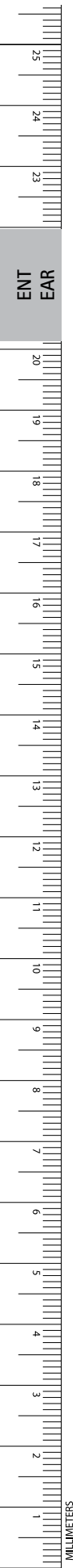

ENT-EAR

Alligator Forceps

NOYES Ear Forceps

Catalog Number	Tip Size (mm)	Jaw	Working Length (in.)
MA168R	6	SERR	3
MA169R	7	SERR, 1 x 2 TEETH	3

MA168R-MA169R



1/2



1/1



2/1

MA168R



1/1



2/1

MA169R

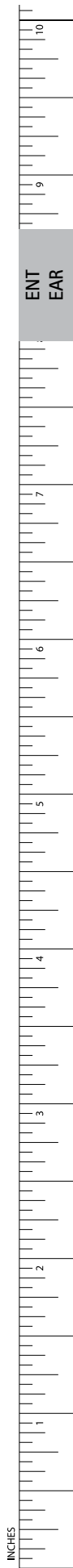

INCHES

ENT-EAR

Alligator Cup and Punch Forceps

MA248R-MA249R

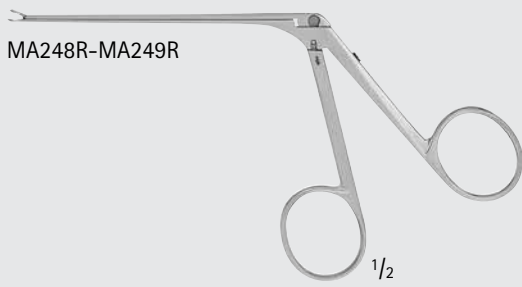

1/2



MA248R

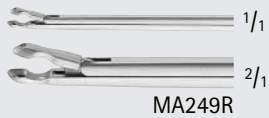

MA249R

Cup Forceps

Catalog Number	Jaw	Cup Size (mm)	Working Length (in.)
MA249R	FINE	0.7 x 1.0	2 3/4
MA248R	EXTRA FINE	0.9 x 2.0	2 3/4

MA240R-MA241R



1/2



MA240R

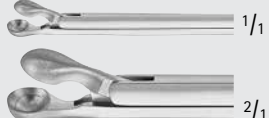

MA241R

MA242R

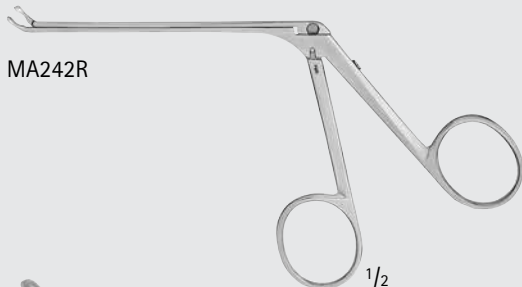

1/2



MA242R

HARTMANN-HERZFELD Cup Forceps

Catalog Number	Jaw	Cup Size (mm)	Working Length (in.)
MA240R	STR	1.5	3 1/8
MA241R	STR	3.0	3 1/8
MA242R	UPBITE	2.0	3 1/8

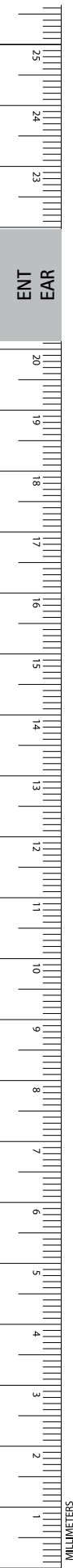

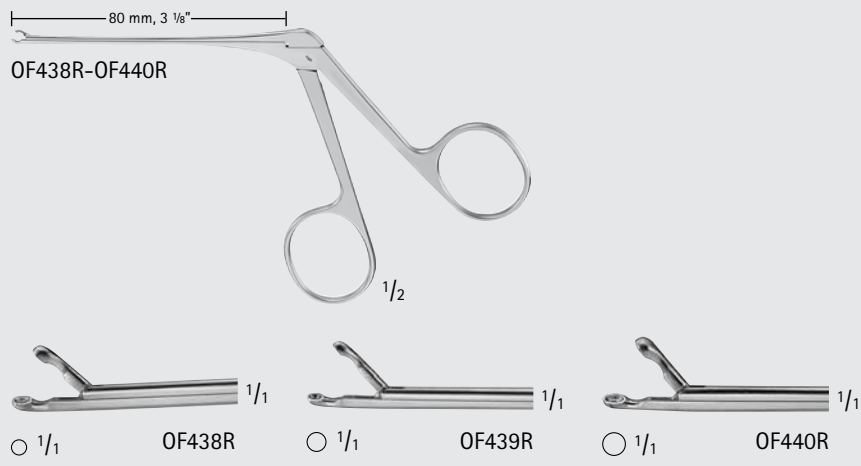

HARTMANN Cup Forceps

Catalog Number	Cup Size (mm)	Jaw	Working Length (in.)
OF438R	2.0	STR	3 1/8
OF439R	2.5	STR	3 1/8
OF440R	3.0	STR	3 1/8

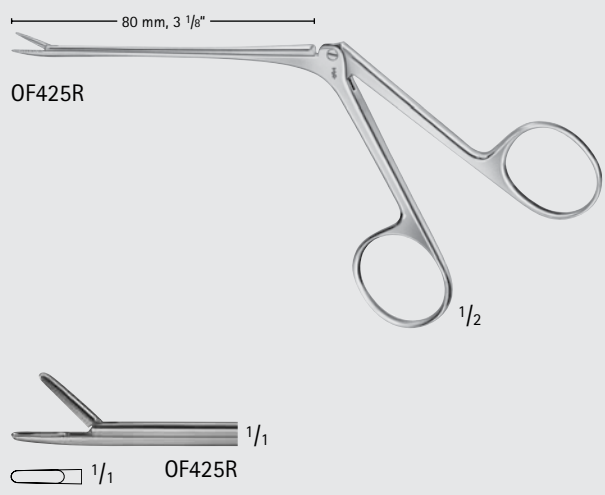

HARTMANN Forceps, Oval

Catalog Number	Cup Size (mm)	Jaw	Working Length (in.)
OF425R	2 x 7	STR	3 1/8

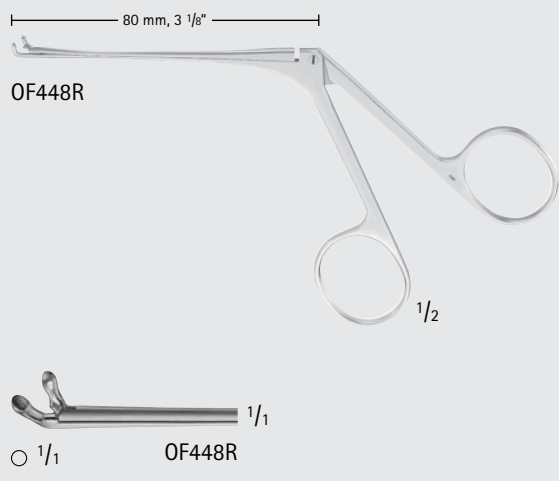

HARTMANN-CITELLI Cup Forceps

Catalog Number	Cup Size (mm)	Jaw	Working Length (in.)
OF448R	2.0	UPBITE	3 1/8

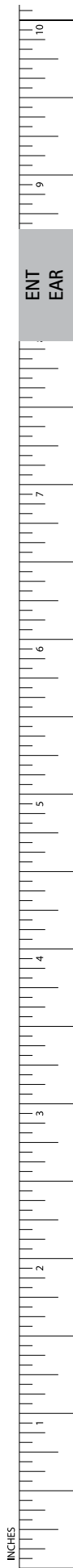

INCHES

ENT-EAR

Alligator Cup and Punch Forceps

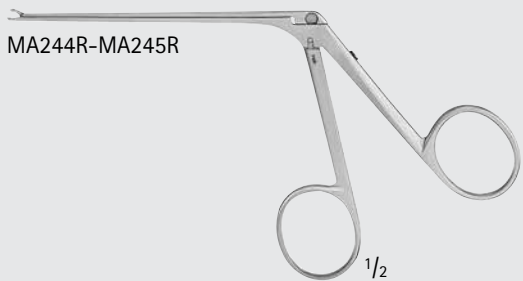
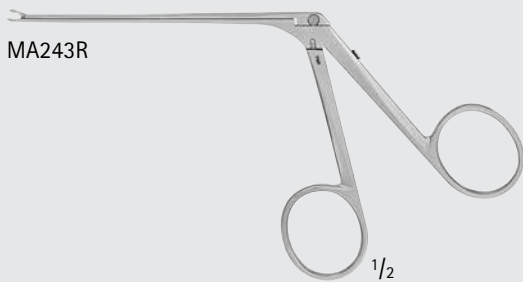
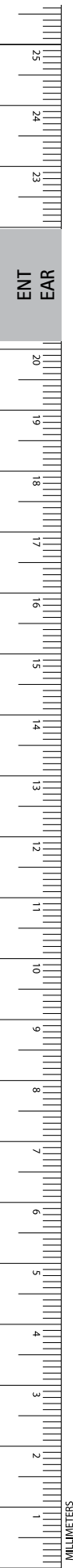

HOUSE Cup Forceps, Miniature

Catalog Number	Cup Size (mm)	Jaw	Working Length (in.)
MA243R	0.6 x 1.0	STR	3 1/8
MA244R	0.6 x 1.0	ANG 15° LEFT	5 1/8
MA245R	0.6 x 1.0	ANG 15° RIGHT	5 1/8

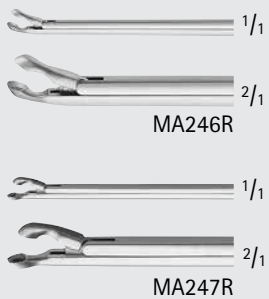

HOUSE Oval Cup Forceps

Catalog Number	Cup Size (mm)	Jaw	Working Length (in.)
MA247R	0.9	ANG 15° LEFT	2 3/4
MA246R	0.9	ANG 15° RIGHT	2 3/4

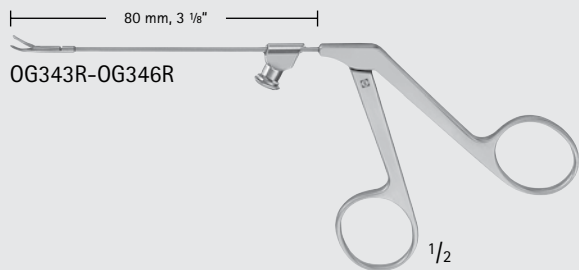

WULLSTEIN Micro Cup Forceps

Catalog Number	Cup Size (mm)	Jaw	Working Length (in.)
OG345R	0.8 x 1.3	STR	3 1/8
OG348R	1.7 x 2.5	STR	3 1/8
OG343R	0.8 x 1.3	CVD-LEFT	3 1/8
OG344R	0.8 x 1.3	CVD-RIGHT	3 1/8
OG346R	1.0	STR, ROUND	3 1/8

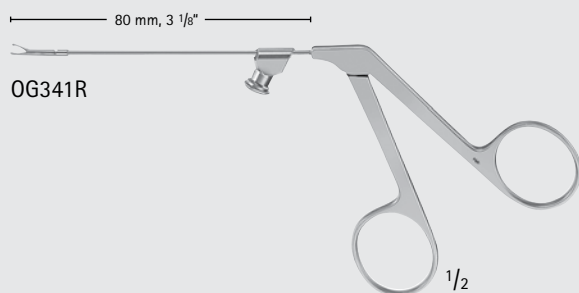
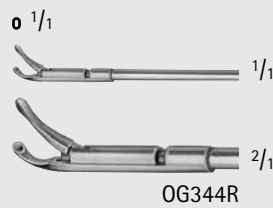
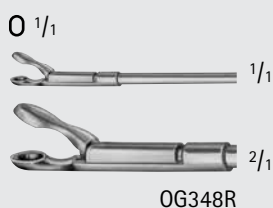
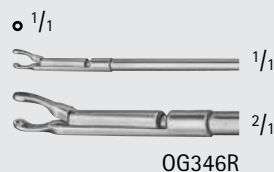
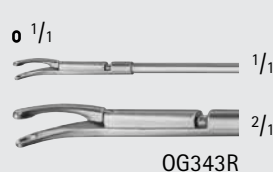
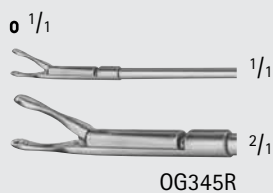

Micro Cup Forceps

Catalog Number	Cup Size (mm)	Jaw	Working Length (in.)
OG341R	0.9 x 1	STR	3 1/8
OG342R	0.9 x 1	CVD, UP	3 1/8

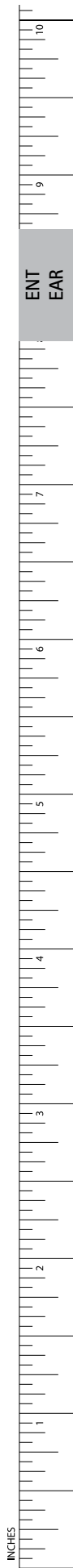
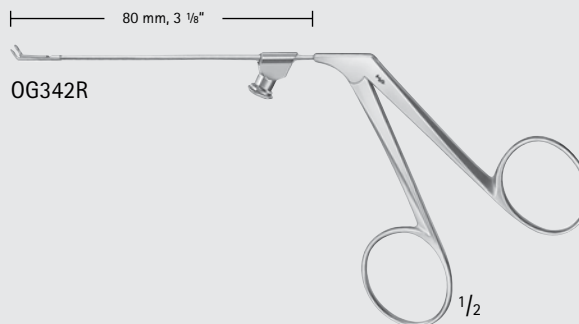

INCHES

ENT-EAR

Nippers/Crimping Forceps/Wire Guides/Cutters/Snares

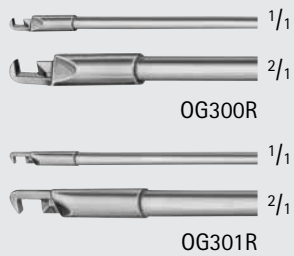
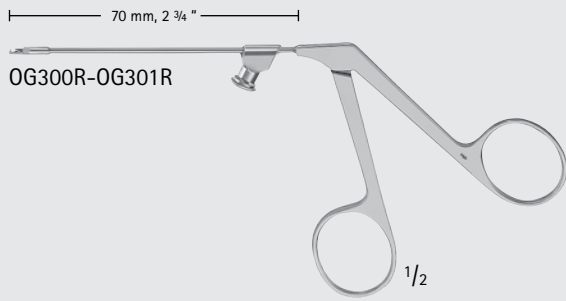

DIETER Malleus Nipper

Catalog Number	Tip	Working Length (in.)
OG300R	UP BITE	2 3/4
OG301R	DOWN BITE	2 3/4

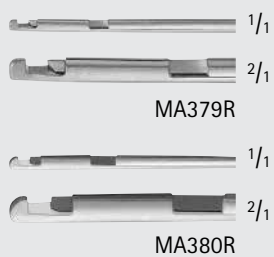
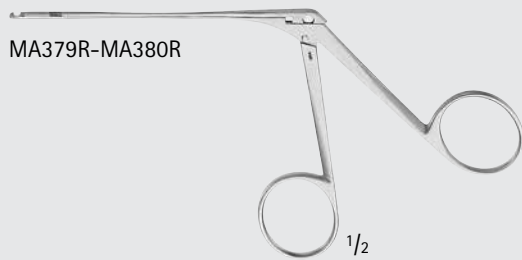

HOUSE-DIETER Malleus Nipper

Catalog Number	Jaw Length (mm)	Working Length (in.)
MA379R	1.5	3 1/8
MA380R	2.0	3 1/8

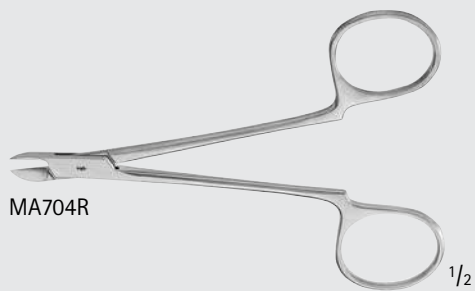

LEMPERT Malleus Cutter

Catalog Number	Jaw Length (mm)	Length (in.)
MA704R	11	4 1/2

ENT
EAR

MILLIMETERS

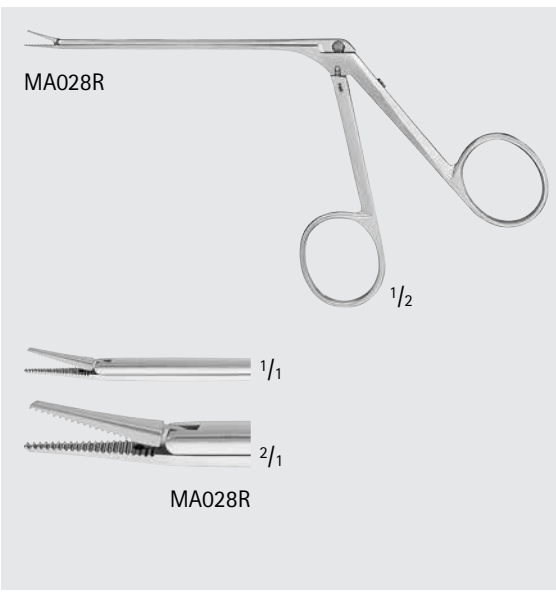
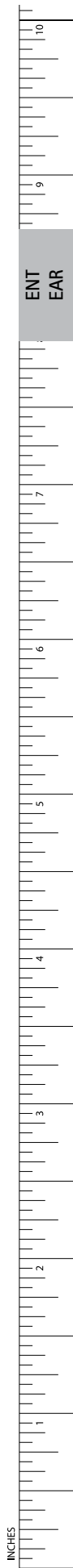

HOUSE Alligator Crimper

Catalog Number	Jaw Length (mm)	Tip	Working Length (in.)	Length (in.)
MA028R	8	SERR	2 7/8	5 1/8

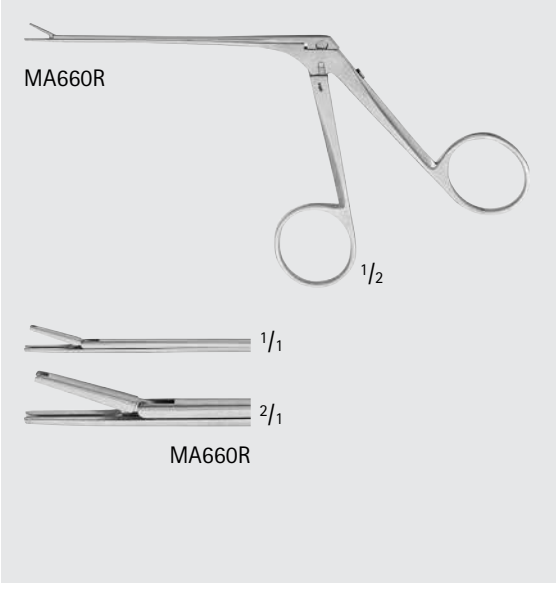

SCHEER Wire Crimper

Catalog Number	Jaw Length (mm)	Tip	Working Length (in.)	Length (in.)
MA660R	7	SMOOTH	3 1/4	5 1/8

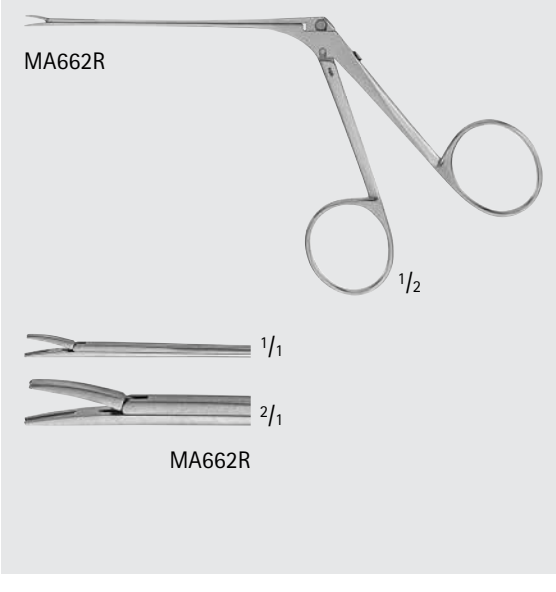

SCHUKNECHT Wire Crimper

Catalog Number	Jaw Length (mm)	Working Length (in.)	Length (in.)
MA662R	3	3 1/8	5 1/8

ENT-EAR

Nippers/Crimping Forceps/Wire Guides/Cutters/Snares

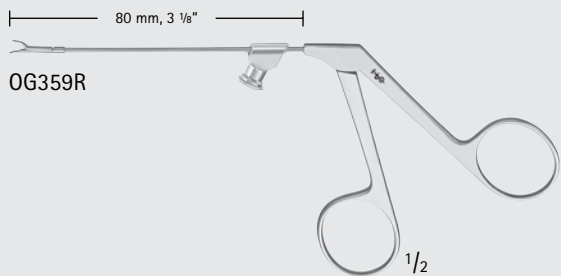

OG359R



OG359R

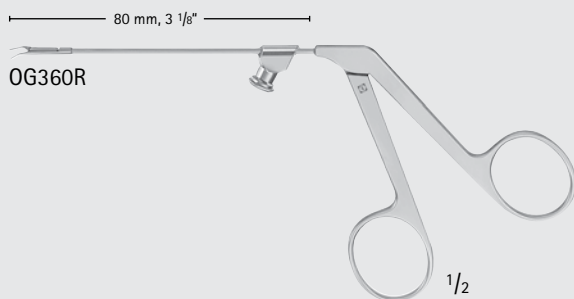

OG360R



OG360R

MCGEE Wire Crimper

Catalog Number	Tip Size (mm)	Blade	Working Length (in.)
OG359R	3.5	CVD-DOWN	3 1/8
OG360R	5	CVD-DOWN	3 1/8



MA456R

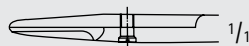

MA456R

GUILFORD-WRIGHT Wire Cutter

Catalog Number	Jaw	Length (in.)
MA456R	SERR	3 3/8

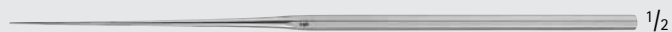

MA298R



MA298R

HOUSE Strut Guide

Catalog Number	Tip Size (mm)	Tip	Length (in.)
MA298R	0.6	ANG	6 1/2

ENT
EAR

MILLIMETERS

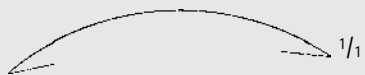

OF528R

Ear Snare Wire, Pkg/100

Catalog Number	Diameter (mm)
OF528R	0.2



OF505R

KRAUSE Ear Snare, Extra Delicate

Catalog Number	Length (in.)
OF505R	6 1/4

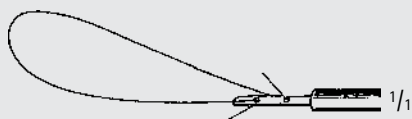

OF505R

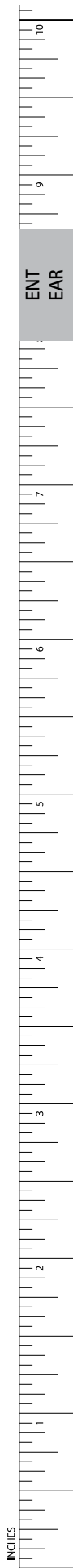

INCHES

ENT-EAR

Hooks and Probes

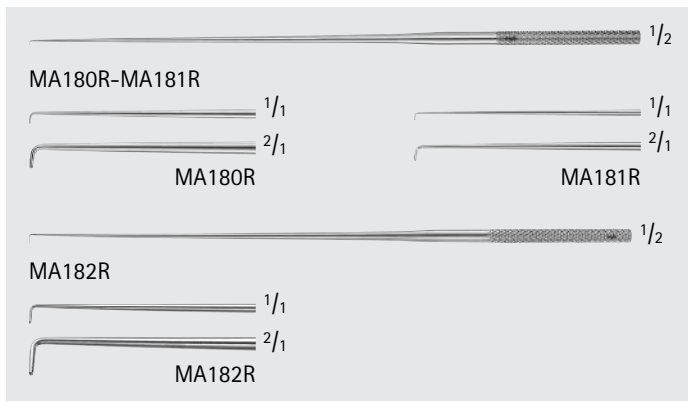
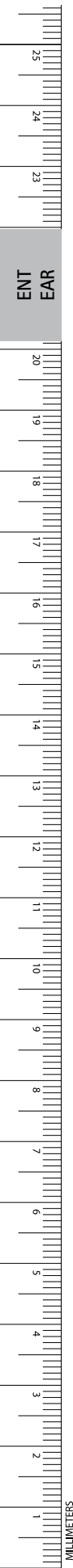

DAY Ear Hook

Catalog Number	Size	Tip Size (mm)	Tip	Length (in.)
MA180R	X-SMALL	1.5	ANG 90°	6 1/4
MA181R	SMALL	2.0	ANG 90°	6 1/4
MA182R	LARGE	2.5	ANG 90°	6 1/4

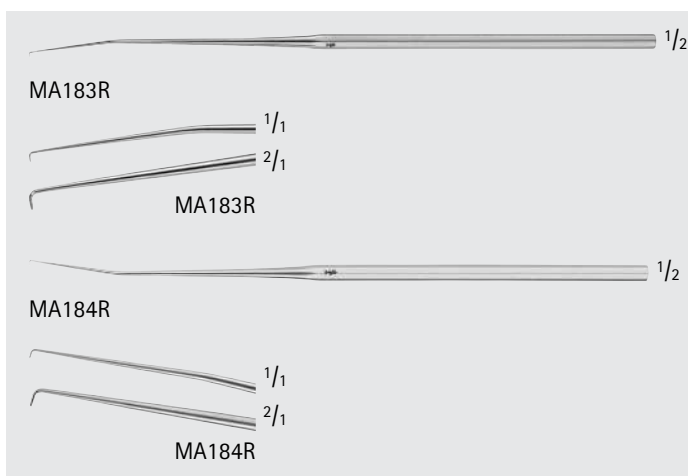

HOUSE Hook Ear Hook

Catalog Number	Tip Size (mm)	Tip	Length (in.)
MA183R	1	ANG 90° LEFT	6 5/8
MA184R	1	ANG 90° RIGHT	6 5/8

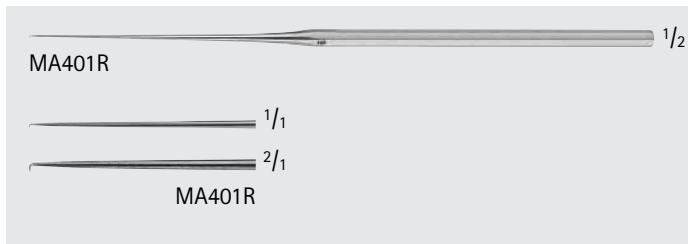

SAUNDERS-PAPARELLA Stapes Hook

Catalog Number	Tip Size (mm)	Tip	Tip Size (#)	Length (in.)
MA401R	0.5	ANG 90°, MALLEABLE	9	6 1/2

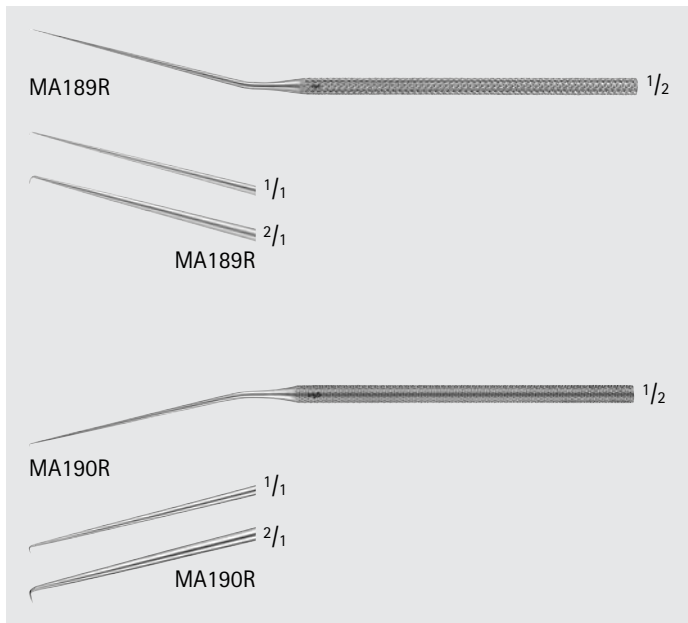

SCHUKNECHT Hook

Catalog Number	Tip Size (mm)	Tip	Length (in.)
MA189R	0.4	ANG-UP, ANTERIOR	6 1/4
MA190R	0.6	ANG-DOWN, POSTERIOR	6 1/4



OG007R-OG014R

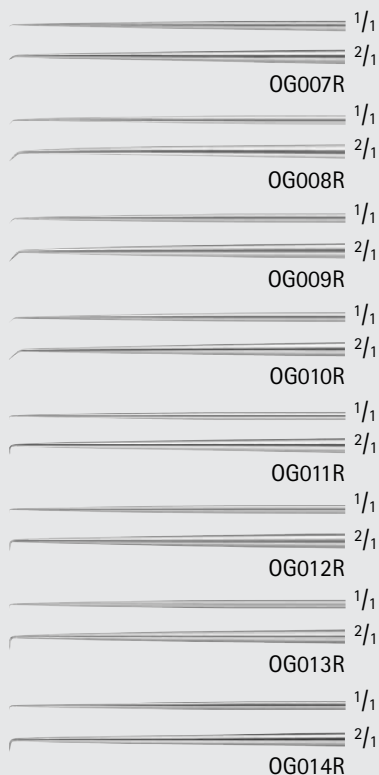

SHAMBAUGH Fen Hook

Catalog Number	Tip Size (mm)	Angle	Length (in.)
OG007R	0.4	45°	6 1/4
OG008R	0.6	45°	6 1/4
OG009R	0.8	45°	6 1/4
OG010R	1.0	45°	6 1/4
OG011R	0.4	90°	6 1/4
OG012R	0.6	90°	6 1/4
OG013R	0.8	90°	6 1/4
OG014R	1.0	90°	6 1/4



OF277R-OF279R

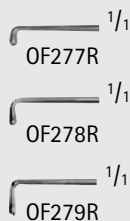

LUCAE Ear Hook Button

Catalog Number	Size	Length (in.)
OF277R	SMALL	5 1/2
OF278R	MEDIUM	5 1/2
OF279R	LARGE	5 1/2



OF282R-OF285R

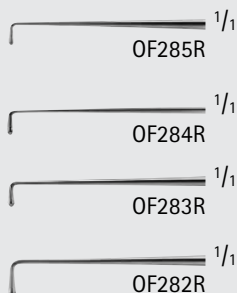

WAGENER Nerve Hook Button

Catalog Number	Size	Length (in.)
OF285R	X-SMALL	6
OF284R	SMALL	6
OF283R	MEDIUM	6
OF282R	LARGE	6



INCHES

ENT-EAR

Retractors

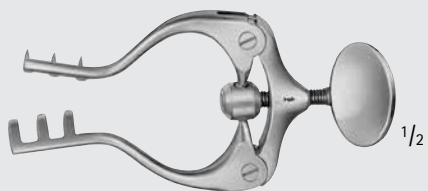

BV030R



BV030R



BV032R



BV032R



BV033R

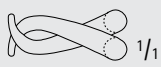

BV033R

JANSEN Retractor

Catalog Number	Tip	Blade End	Length (in.)
BV030R	SHARP	3 x 3 PRONGS	4
BV032R	BLUNT	3 x 3 PRONGS	4
BV033R	BLUNT	3 x 4 PRONGS	4

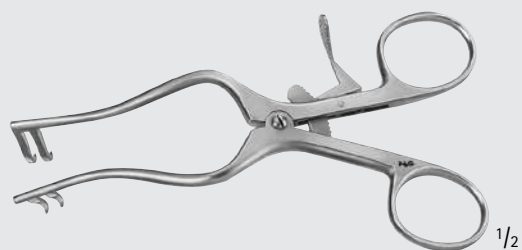

BV078R

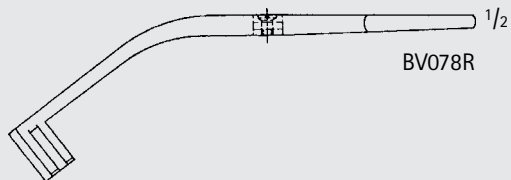

BV078R



1/1

PLESTER-PAPARELLA-WEITLANER Retractor

Catalog Number	Tip	Blade End	Length (in.)
BV078R	SHARP	2 x 2 PRONGS	5 1/8

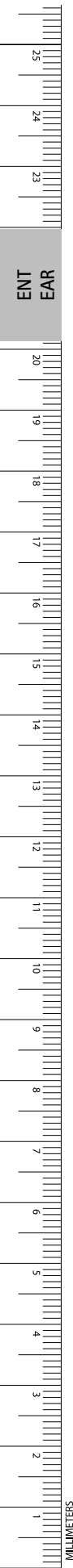

SCHUKNECHT Retractor

Catalog Number	Tip	Blade End	Length (in.)
MA433R	ANG, SHARP	3 x 3 PRONGS	5 1/8

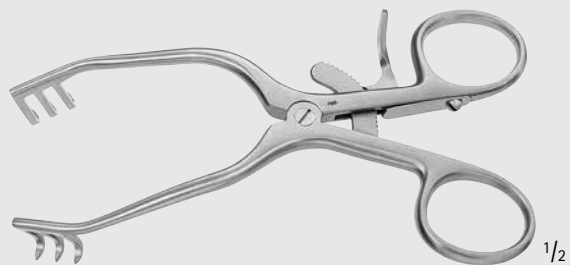

MA433R



MA433R

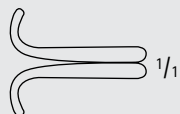

1/1

HOUSE Hand Retractor, Double Ended

Catalog Number	Blade Size (mm)	Length (in.)
MA432R	20 x 7 / 25 x 9	6

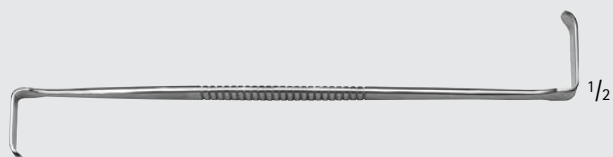

MA432R



1/1



1/1

MA432R

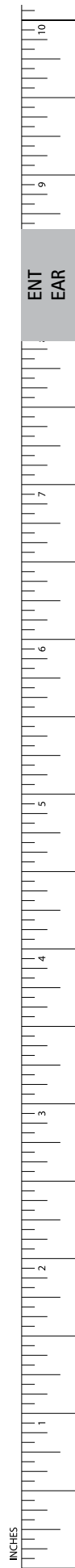

INCHES

ENT-EAR

Picks

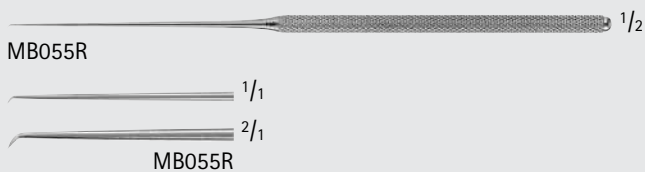

AUSTIN Pick

Catalog Number	Tip Size (mm)	Tip	Length (in.)
MB055R	1.0	ANG 45°	6 1/4

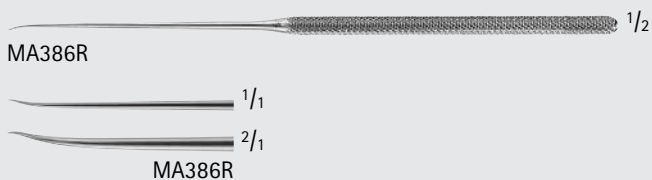

BELLUCCI Pick

Catalog Number	Tip	Tip Size (mm)	Length (in.)
MA386R	CVD POINT, 4 MM FROM TIP	-	6 5/8
MA388R	ANG 90°	0.5	6 5/8

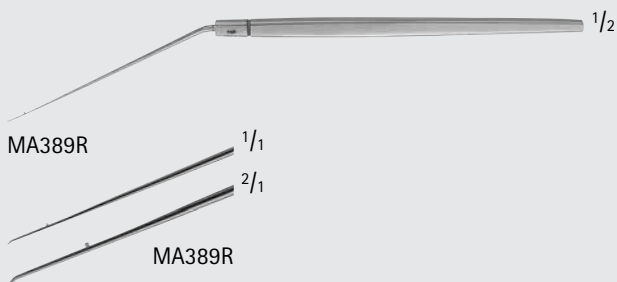
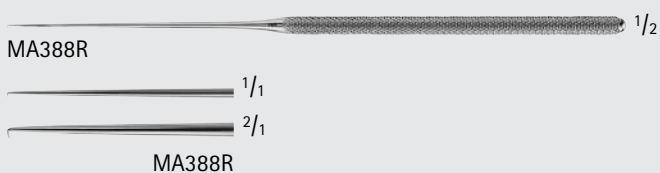

FARRIOR Footplate Pick, with Notch

Catalog Number	Tip	Shaft	Length (in.)
MA389R	ANTERIOR, CVD-RIGHT	ANG	5 7/8
MA390R	POSTERIOR, CVD-LEFT	ANG	5 7/8

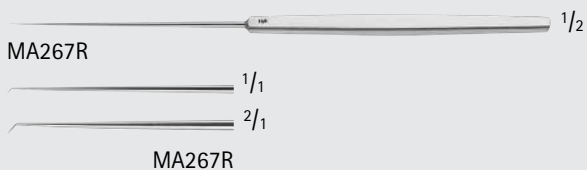
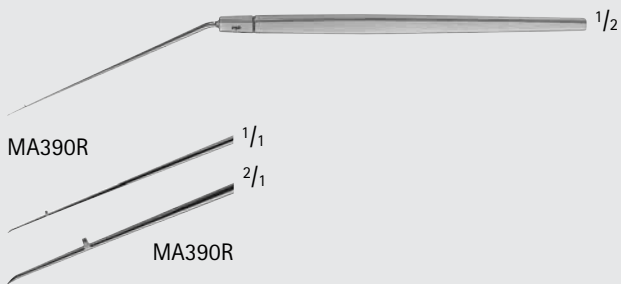

GUILFORD-WRIGHT Footplate

Catalog Number	Tip Size (mm)	Tip	Length (in.)
MA267R	0.5	ANG 45°	5 1/2

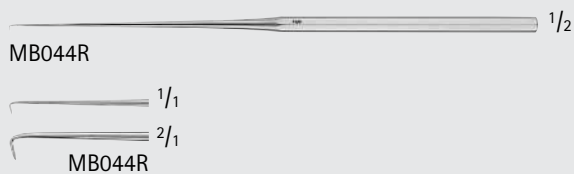

GUILFORD-WRIGHT Stapes Pick, Heavy

Catalog Number	Tip	Length (in.)
MB044R	ANG 90°	5 1/2

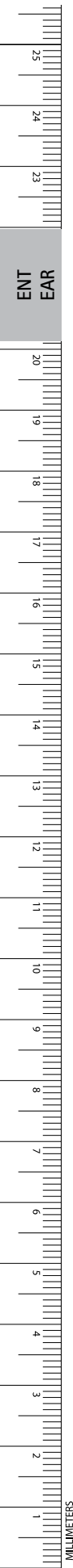

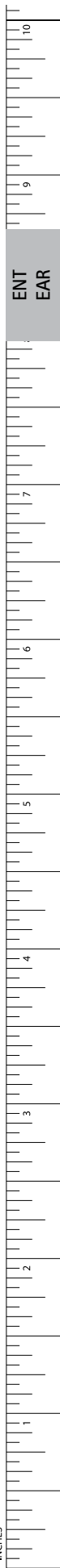

MA391R 1/2

MA391R 1/1

MA391R 2/1

MA391R

Catalog Number	Tip	Length (in.)
MA391R	CVD	5 7/8

MA392R 1/2

MA392R 1/1

MA392R 2/1

MA392R

Catalog Number	Tip	Length (in.)
MA392R	STR	5 7/8

MA069R 1/2

MA069R 1/1

MA069R 2/1

MA069R

Catalog Number	Tip Size (mm)	Tip	Length (in.)
MA069R	2.5	ANG 90°	6 5/8

MA272R-MA273R 1/2

MA272R-MA273R 1/1

MA272R-MA273R 2/1

MA272R-MA273R

MA284R 1/2

MA284R 1/1

MA284R 2/1

MA284R

MA393R 1/2

MA393R 1/1

MA393R 2/1

MA393R

Catalog Number	Tip Size (mm)	Tip	Shaft	Length (in.)
MA272R	0.33	ANG 30°	-	6 1/2
MA273R	0.66	ANG 30°	-	6 1/2
MA284R	0.33	ANG 90°	FINE	6 1/2
MA393R	0.33	ANG 90°	MEDIUM	6 5/8

ENT-EAR

Picks

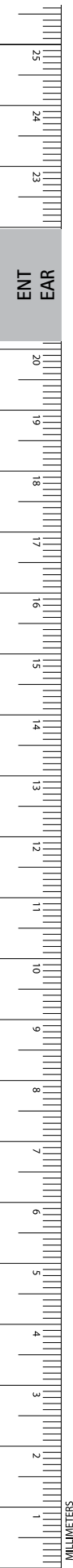

MA396R-MA397R $1/2$

$1/1$

$2/1$

MA397R

$1/1$

$2/1$

MA396R

MA395R $1/2$

$1/1$

$2/1$

MA395R

MA394R $1/2$

$1/1$

$2/1$

MA394R

MA406R $1/2$

$1/1$

$2/1$

MA406R

MA405R $1/2$

$1/1$

$2/1$

MA405R

HOUSE Strut Pick

Catalog Number	Tip Size (mm)	Tip	Length (in.)
MA397R	0.5	ANG 90°	6 1/2
MA396R	0.66	ANG 90°	6 1/2
MA395R	0.75	ANG 90°	6 1/2
MA394R	1.0	ANG 90°	6 1/2
MA406R	1.5	ANG 90°	6 1/2
MA405R	3.0	ANG 90°	6 1/2

MA251R $1/2$

$1/1$

$2/1$

MA251R

HOUSE-BARBARA Pick, Malleable

Catalog Number	Tip	Length (in.)
MA251R	STR	6 1/2

KOS Pick, Bayonet-Shaped

Catalog Number	Tip Size (mm)	Tip	Length (in.)
MA399R	85	STR	7
MA398R	-	ANG-UP 90°	7

MCGEE Footplate Pick

Catalog Number	Tip Size (mm)	Tip	Shaft	Length (in.)
MA261R	0.2	ANTERIOR	ANG-UP	6 1/2
MA402R	0.2	POSTERIOR	ANG-DOWN	6 1/2
MA263R	1.0	ANTERIOR	ANG-UP	6 1/2
MA264R	1.0	POSTERIOR	ANG-DOWN	6 1/2

PAPARELLA Pick

Catalog Number	Tip Size (#)	Tip	Length (in.)
MA403R	17	LEFT	6 1/2
MA404R	16	RIGHT	6 1/2

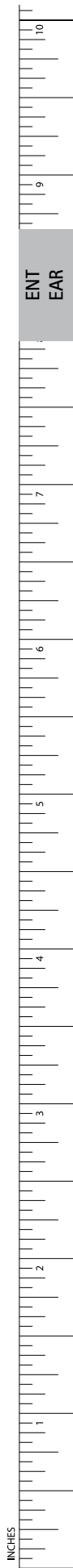

ENT-EAR

Specula and Holders



US101-US103



US101



US102



US103

Ear Speculum, Oval, Ebony

Catalog Number	Tip Size (mm)
US101	4.5 x 5.5
US102	5.5 x 6.5
US103	6.5 x 7.5



OF102C-OF104C



OF102C



OF103C



OF104C

POLITZER Ear Speculum, Round, Pediatric

Catalog Number	Tip Size (mm)
OF101C	SET OF 3 OF102C-OF104C
OF102C	2
OF103C	3
OF104C	4



OF121C-OF124C



OF121C



OF122C



OF123C



OF124C

BOUCHERON Ear Speculum, Round, Adult

Catalog Number	Tip Size (mm)
OF120C	SET OF 4 OF121C-OF124C
OF121C	4.2
OF122C	5.2
OF123C	6.2
OF124C	7.2



MA077R-MA080R



MA077R



MA078R



MA079R



MA080R

BOUCHERON Ear Speculum, Round, Large

Catalog Number	Tip Size (mm)
MA076R	SET OF 4 MA077R-MA080R
MA077R	5.5
MA078R	6.6
MA079R	7.5
MA080R	9.0





MA072R-MA075R

1/1



MA072R



MA073R



MA074R

BOUCHERON Ear Speculum, Round, Small

Catalog Number	Size (#)	Tip Size (mm)
MA071R	-	SET OF 4 MA072R-MA075R
MA072R	1	3.0
MA073R	2	4.0
MA074R	3	4.5
MA075R	4	5.0



MA075R



MA090R-MA096R,
MA648R-MA649R

1/1



MA648R



MA649R



MA090R



MA093R



MA094R



MA095R

FARRIOR Ear Speculum, Oval, Oblique

Catalog Number	Size (#)	Tip Size (mm)
MA648R	XX-SMALL	3 x 4
MA649R	X-SMALL	4 x 5
MA089R	-	SET OF 7 MA090R-MA096R
MA090R	1	5 x 6
MA091R	2	6 x 7
MA092R	3	7 x 8
MA093R	4	8 x 10
MA094R	5	9 x 11
MA095R	6	10 x 12
MA096R	7	11 x 13



MA091R

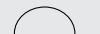

MA092R

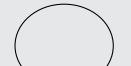

MA096R



MA097R-MA104R

1/1



MA098R



MA099R



MA100R



MA103R



MA104R

FARRIOR Ear Speculum, Round, Oblique

Catalog Number	Size (#)	Tip Size (mm)
MA097R	-	SET OF 7 MA098R-MA104R
MA098R	1	6
MA099R	2	7
MA100R	3	8
MA101R	4	9
MA102R	5	10
MA103R	6	11
MA104R	7	12



MA101R

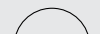

MA102R



ENT-EAR

Specula and Holders



MA082R-MA088R,
MA646R-MA647R

FARRIOR Ear Speculum, Oval, Regular

Catalog Number	Size (#)	Tip Size (mm)
MA646R	XX-SMALL	3 x 4
MA647R	X-SMALL	4 x 5
MA081R	-	SET OF 7 MA082R-MA088R
MA082R	1	4.5 x 6
MA083R	2	5.5 x 7
MA084R	3	6.5 x 8
MA085R	4	7.5 x 9
MA086R	5	8 x 10
MA087R	6	9 x 11.25
MA088R	7	10 x 12.5



MA646R



MA647R



MA082R



MA083R



MA084R



MA085R



MA086R



MA087R



MA088R



MA106R-MA112R

FARRIOR Ear Speculum, Round, Regular

Catalog Number	Size (#)	Tip Size (mm)
MA105R	-	SET OF 7 MA106R-MA112R
MA106R	1	5.0
MA107R	2	6.0
MA108R	3	7.0
MA109R	4	8.0
MA110R	5	9.0
MA111R	6	10.0
MA112R	7	10.5



MA106R



MA107R



MA108R



MA109R



MA110R



MA111R



MA112R

ENT
EAR

1
2
3
4
5
6
7
8
9
10
11
12
13
14
15
16
17
18
19
20
23
24
25
MILLIMETERS



MB137R, MA650R-MA652R

GRUBER Ear Speculum, Oval, Infant

Catalog Number	Size (#)	Tip Size (mm)
MB242R	SMALL	2.0 x 2.5
MB243R	MEDIUM	2.5 x 3.0
MB244R	LARGE	3.0 x 4.0



MB242R



MB243R



MB244R



MA117R

GRUBER Ear Speculum, Oval, Infant, Long

Catalog Number	Tip Size (mm)
MA117R	4.5 x 5.0



MA117R



MA119R-MA121R

GRUBER Ear Speculum, Oval, Light

Catalog Number	Size (#)	Tip Size (mm)
MA118R	-	SET OF 3 MA119R-MA121R
MA119R	1	1.6 x 2.4
MA120R	2	2.4 x 3.2
MA121R	3	3.2 x 4.7



MA119R



MA120R



MA121R



MA114R-MA116R

GRUBER Ear Speculum, Oval, Heavy, Long

Catalog Number	Size (#)	Tip Size (mm)
MA114R	1	5 x 6
MA115R	2	6 x 7
MA116R	3	7 x 8



MA114R



MA115R



MA116R



ENT
EAR

INCHES

ENT-EAR

Specula and Holders



MA125R-MA127R



MA125R



MA126R



MA127R

GRUBER Ear Speculum, Round, Short, Light

Catalog Number	Size (#)	Tip Size (mm)
MA124R	-	SET OF 3 MA125R-MA127R
MA125R	1	3 x 33
MA126R	2	4 x 35
MA127R	3	5 x 37



MA128R

GRUBER Ear Speculum, Round, Long, Heavy

Catalog Number	Description
MA128R	SET OF 3



MA130R-MA136R



MA130R



MA136R

HARTMANN Ear Speculum, Infant

Catalog Number	Tip	Tip Size (mm)
MA130R	ROUND	2.5
MA136R	OVAL	2.5 x 3



OF115C-OF117C



OF115C



OF116C



OF117C

HARTMANN Ear Speculum, Infant

Catalog Number	Tip Size (mm)
OF115C	1.8
OF116C	3.2
OF117C	4.6



MA132R-MA135R



MA132R



MA133R



MA134R



MA135R

HARTMANN Ear Speculum, Oval

Catalog Number	Size (#)	Tip Size (mm)
MA131R	-	SET OF 4 MA132R-MA135R
MA132R	1	4.5 x 5.5
MA133R	2	5.5 x 6
MA134R	3	6.5 x 7
MA135R	4	7.5 x 8

ENT
EAR

MM
MILLIMETERS



1/1

MA129R, MA650R-MA652R



1/1

MA650R



1/1

MA651R



1/1

MA137R



1/1

MA652R

HARTMANN Ear Speculum, Round, Adult

Catalog Number	Size (#)	Tip Size (mm)
MA129R	-	SET OF 4 MA137R, MA650R-MA652R
MA650R	1	4
MA651R	2	5
MA137R	3	6
MA652R	4	7



1/1

OF111C-OF114C



1/1

OF111C



1/1

OF112C



1/1

OF113C



1/1

OF114C

HARTMANN Ear Speculum, Round

Catalog Number	Tip Size (mm)
OF111C	3.5
OF112C	5.0
OF113C	6.5
OF114C	8.0



1/2

MA606R

SHEA Speculum Holder

Catalog Number	Length (in.)
MA606R	11 3/4



ENT
EAR

INCHES

ENT-EAR

Applicators and Searchers

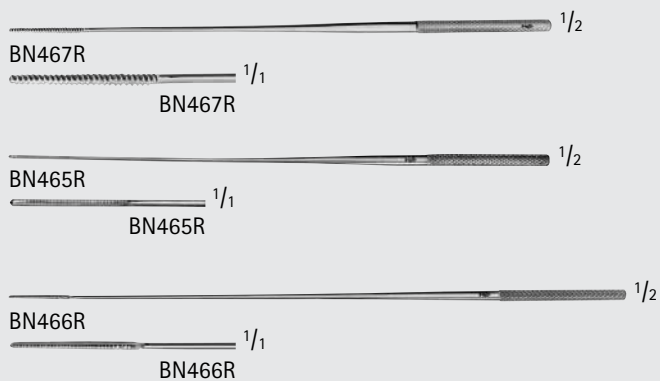

LATHBURY-FARRELL Cotton Applicator, Triangular Serrated

Catalog Number	Tip Size (mm)	Length (in.)
BN467R	0.9	5 1/2
BN465R	1.4	5 1/2
BN466R	1.2	6 1/4

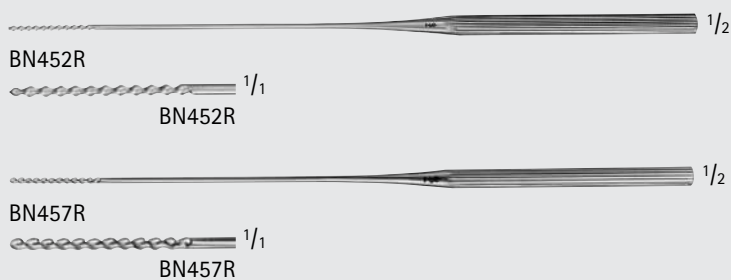

Cotton Applicator, Spiral

Catalog Number	Tip Size (mm)	Length (in.)
BN452R	1.5	7
BN457R	1.8	7

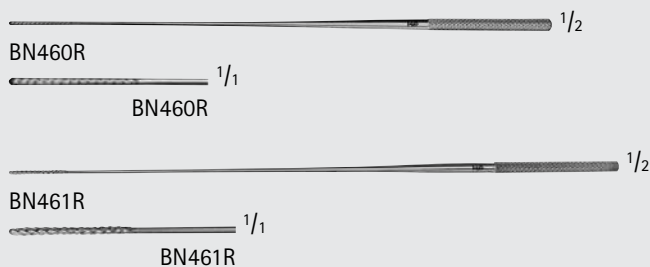

FARRELL Cotton Applicator

Catalog Number	Tip Size (mm)	Tip	Length (in.)
BN460R	1.2	ROUND-SERR	5 1/2
BN461R	1.2	SPIRAL	6 1/4

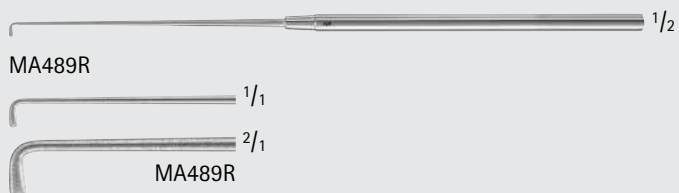

ALLPORT Mastoid Searcher

Catalog Number	Tip Size (mm)	Tip	Length (in.)
MA489R	3	ANG 90°	6 3/4

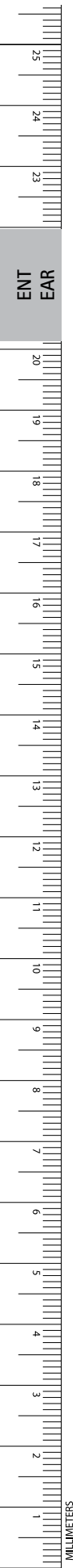

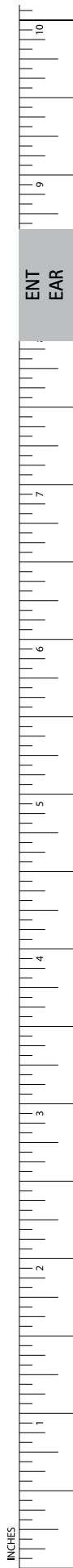

MA230R

Ear Knife Handle, for Myringotomy
Blades with Round Ends

Catalog Number	Length (in.)
MA230R	3 5/8



MA204R

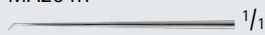

1/1



2/1

MA204R

AUSTIN Dissecting Knife

Catalog Number	Blade Size (mm)	Blade Shape	Length (in.)
MA204R	0.5	ANG 45°	6 1/4



MA210R

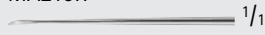

1/1



2/1

MA210R



MA209R

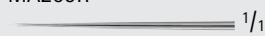

1/1



2/1

MA209R

DERLACKI Capsule Knife

Catalog Number	Blade Size (mm)	Blade Shape	Length (in.)
MA210R	0.25	ANG 20°	6 1/4
MA209R	0.5	SLIGHT CVD	6 1/4



OG100R



1/1



2/1

OG100R

Footplate Knife

Catalog Number	Blade Shape	Length (in.)
OG100R	STR	6 1/4

ENT-EAR

Knives

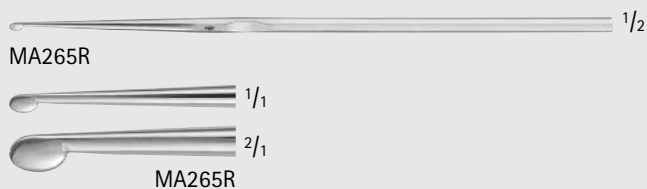

GUILFORD-WRIGHT Flap Knife

Catalog Number	Blade Size (mm)	Length (in.)
MA265R	3.6 x 2.5	6 1/4

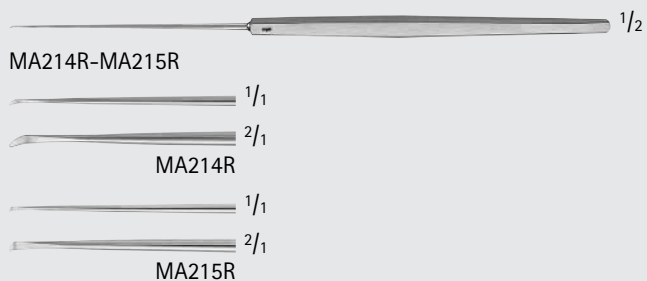

HARRISON Knives

Catalog Number	Size	Blade Shape	Length (in.)
MA214R	SMALL	ANG 45°	6 1/8
MA215R	SMALL	ANG 90°	6 1/8

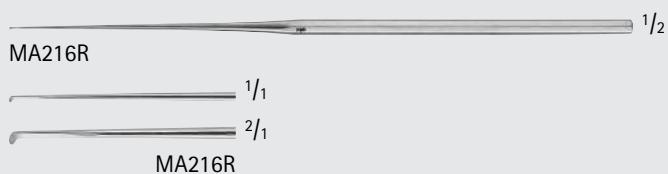

HOUSE Incudostapedial Joint Knife

Catalog Number	Blade Size (mm)	Blade Shape	Length (in.)
MA216R	0.75	ANG 60°	6 5/8

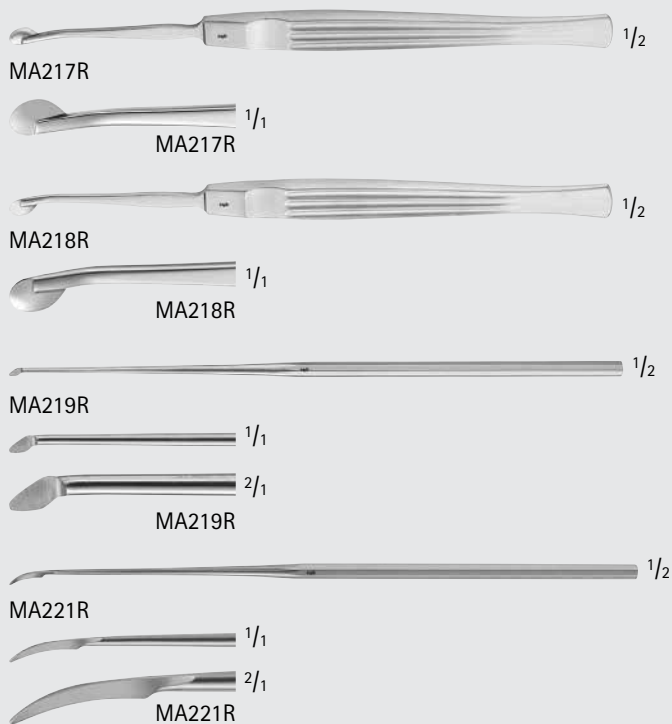

HOUSE Knife

Catalog Number	Blade Size (mm)	Blade Shape	Length (in.)
MA217R	7.0	ANG LEFT	6 1/4
MA218R	7.0	ANG RIGHT	6 1/4
MA219R	2 x 3	ANG 45°	6 1/2
MA221R	7.5	ANG 45°	6 1/2





MA213R

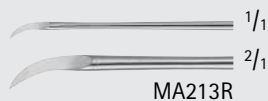

MA213R

GHANDI Knife, Sickle Blade

Catalog Number	Blade Size (mm)	Length (in.)
MA213R	4.0	5 1/8



MA208R



MA208R

CULBERTSON Canal Knife

Catalog Number	Tip Size (mm)	Length (in.)
MA208R	1.4	6 1/4



MA278R



MA278R

JORDAN Canal Knife

Catalog Number	Blade Size (mm)	Blade Shape	Length (in.)
MA278R	2 x 3	ANG 45°	6 1/2



MA222R



MA222R

MCCABE Canal Knife

Catalog Number	Blade Size (mm)	Blade Shape	Length (in.)
MA222R	2.5	ANG 45°	6 1/4



MA227R



MA227R



MA228R



MA228R

PAPARELLA Canal Knife

Catalog Number	Size (#)	Blade Size (mm)	Blade Shape	Length (in.)
MA227R	1	2	STR	6 1/2
MA228R	2	2	STR	6 1/2

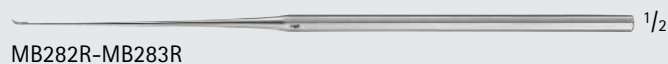

MB282R-MB283R



MB282R



MB283R

PAPARELLA Sickle Knife

Catalog Number	Size (#)	Blade Size (mm)	Blade Shape	Length (in.)
MB282R	14	5	CVD RIGHT	6 1/2
MB283R	15	5	CVD LEFT	6 1/2

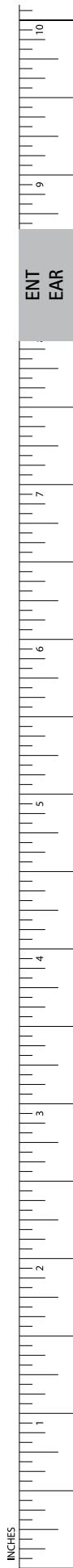

INCHES

ENT-EAR

Knives

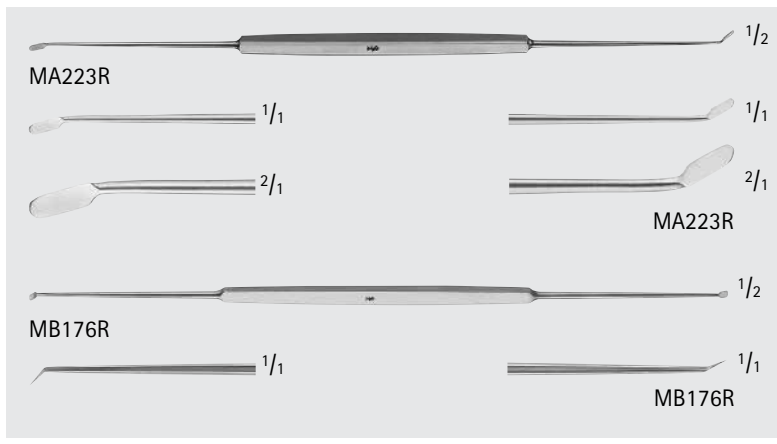
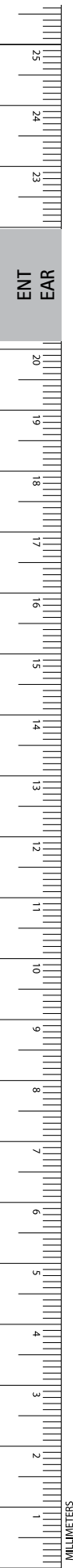

MCCABE Knife Flap Dissector, Double Ended, Angled

Catalog Number	Blade Shape	Length (in.)
MA223R	20° / 45°	7 1/4
MB176R	20° / 40°	7 1/4

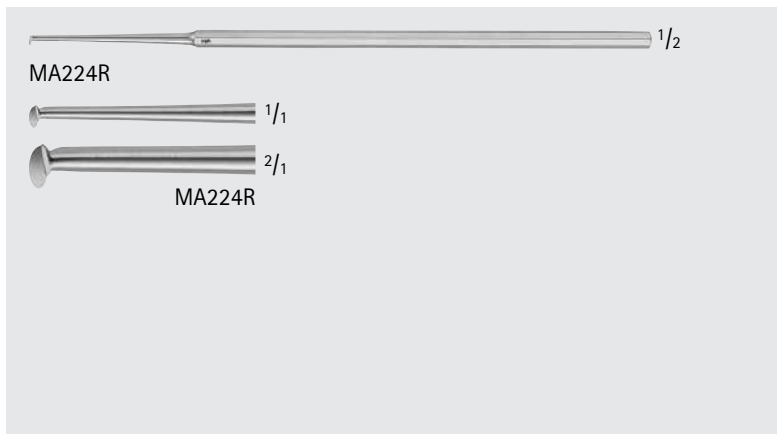

MCHUGH Flap Knife

Catalog Number	Blade Shape	Length (in.)
MA224R	OVAL	6 1/2

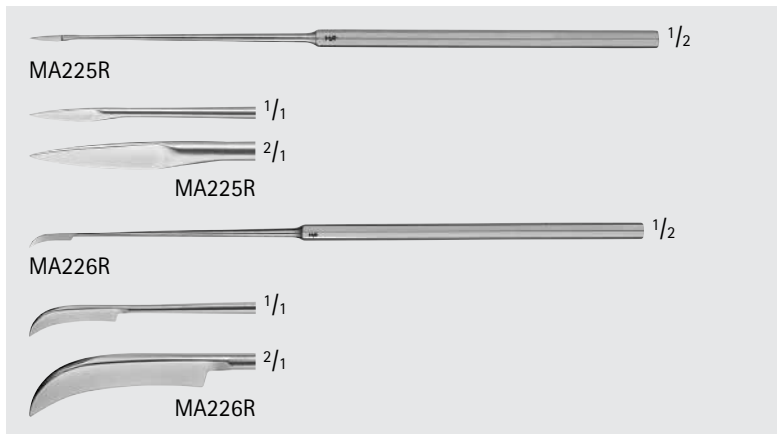

Myringotomy Knife

Catalog Number	Blade Size (mm)	Blade Shape	Length (in.)
MA225R	8	STR	6 1/2
MA226R	9	CVD	6 1/2

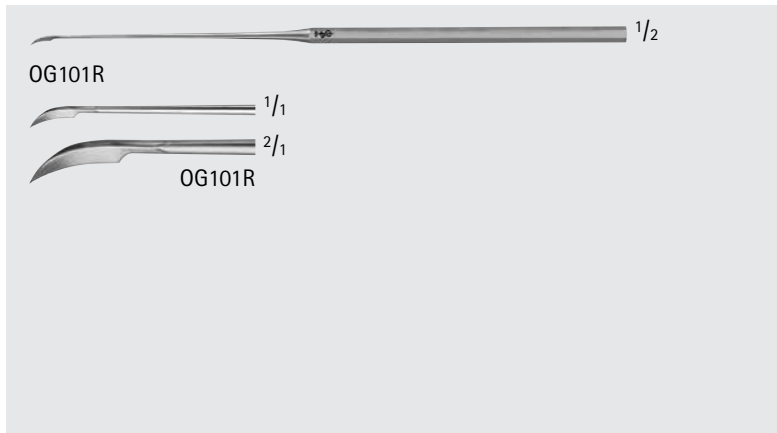

PLESTER Knife, Sickle Knife

Catalog Number	Blade Shape	Length (in.)
OG101R	CVD	6 1/4



OG110R, OG112R, OG133R, OG136R

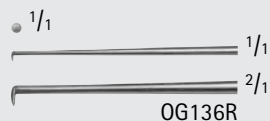
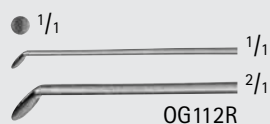
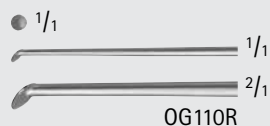
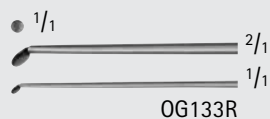

Round Cutting Knife

Catalog Number	Blade Size (mm)	Blade Shape	Length (in.)
OG133R	1.5	45°	6 1/4
OG110R	2.0	45°	6 1/4
OG112R	2.6	45°	6 1/4
OG136R	1.5	90°	6 1/4



OG108R

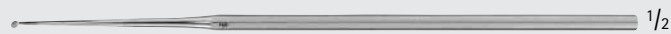
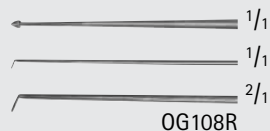

MA292R

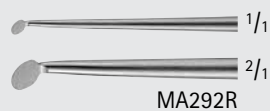

ROSEN Knife

Catalog Number	Blade Size (mm)	Blade Shape	Length (in.)
OG108R	-	SPEAR	6 1/4
MA292R	2	45° UP ROUND	6 1/4



MA644R



ROYCE Ear Knife

Catalog Number	Blade	Blade Size (mm)	Shaft	Length (in.)
MA644R	DOWN-CUTTING	8	ANG	6 1/4



INCHES

ENT-EAR

Knives



OG123R-OG124R

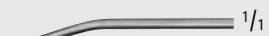

OG123R



OG124R

SCHUKNECHT Roller Knife

Catalog Number	Blade Shape	Length (in.)
OG123R	RIGHT-ANG	6 1/4
OG124R	STR	6 1/4



MA056R-MA057R

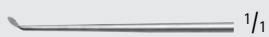

MA056R



MA057R

SHEEHY Knife Curette

Catalog Number	Size	Blade Size (mm)	Blade Shape	Length (in.)
MA056R	SMALL	2.0	WEAPON	6 5/8
MA057R	LARGE	2.5	WEAPON	6 5/8



MA586R



MA586R



MA587R



MA587R

Sickle Knife

Catalog Number	Blade Tip	Blade Size (mm)	Blade Shape	Length (in.)
MA586R	SHARP	10	CVD	7 1/2
MA587R	BLUNT	10	CVD	7 1/2

ENT
EAR

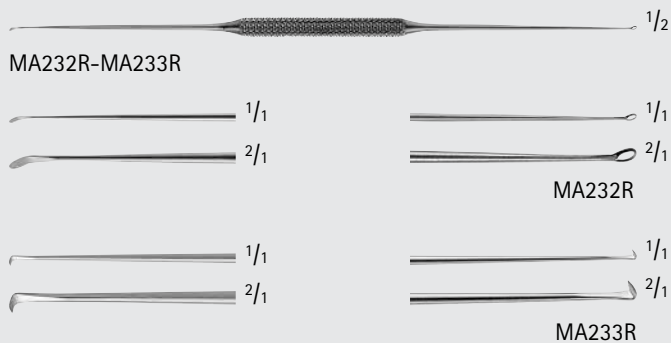

TABB Flap Knife, Double Ended, Angled

Catalog Number	Blade Size (mm)	Blade Shape	Length (in.)
MA232R	0.9 / 1.0	25° / 45°	6 1/2
MA233R	0.9 / 1.0	90° / 115°	6 1/2

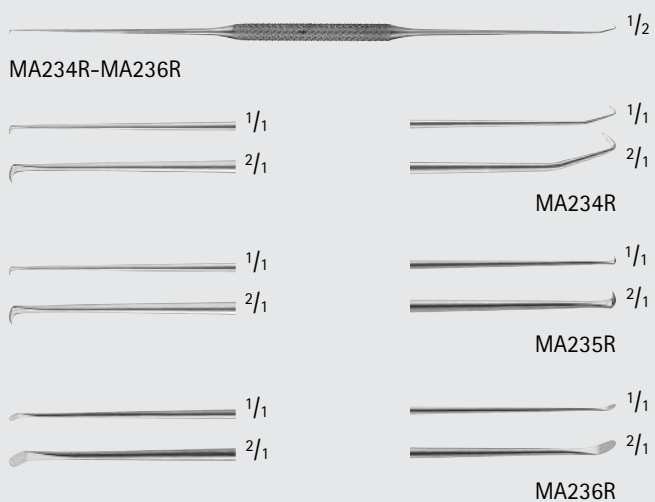

TABB Myringotomy Knife, Double Ended, Angled

Catalog Number	Blade Size (mm)	Blade Shape	Length (in.)
MA234R	1.0 / 1.0	90° / 120°	6 1/4
MA235R	1.3 / 1.3	90° / 115°	6 1/4
MA236R	1.1 / 1.1	25° / 45°	6 1/4

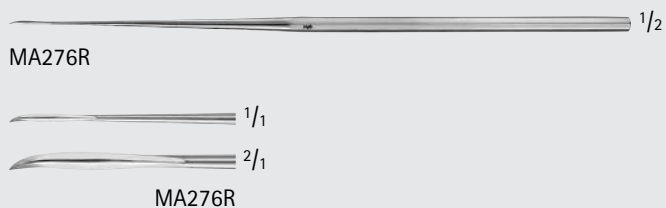

HOUSE Tympanoplasty Knife

Catalog Number	Blade Size (mm)	Blade Shape	Length (in.)
MA276R	7	CVD	6 1/2

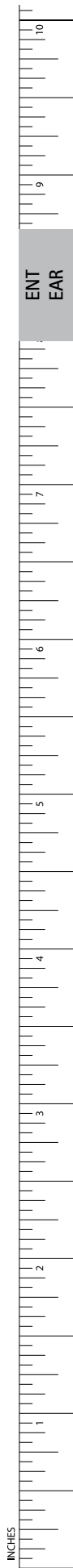

INCHES

ENT-EAR

Suction Irrigation



MA717R-MA718R

ANTHONY Suction Tube, Straight

Catalog Number	Tip Size (mm)	Length (in.)
MA717R	2 I.D.	6 1/8
MA718R	3 I.D.	6 1/8

MA494R

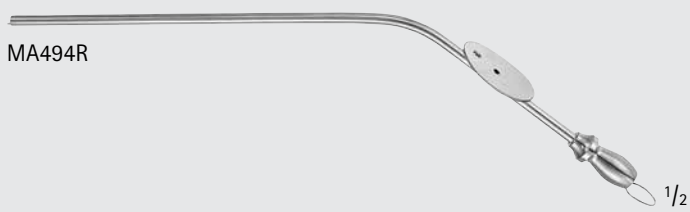

BARNES Hospital Suction Tube

Catalog Number	Tip Size (FR)	Working Length (in.)	Length (in.)
MA494R	9	3 3/4	6 1/8

MB380R-MB382R

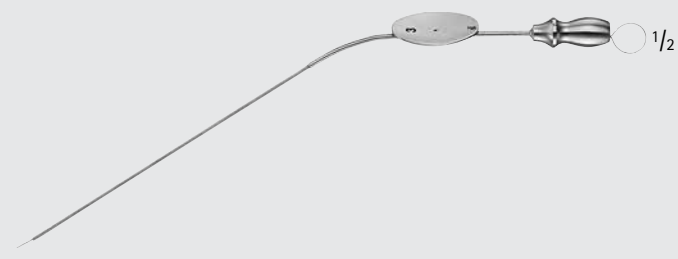

BARON Suction Tube

Catalog Number	Tip Size (FR)	Working Length (in.)	Length (in.)
MB380R	3	4	4
MB381R	5	4	4
MB382R	7	4	4
MD887	3	2 3/4	5 1/2
MD888	5	2 3/4	5 1/2
MD889	7	2 3/4	5 1/2
MG375R	-	-	6

MG375R Stylet may be used with all BARON Suction Tubes

MD887-MD889



MG375R

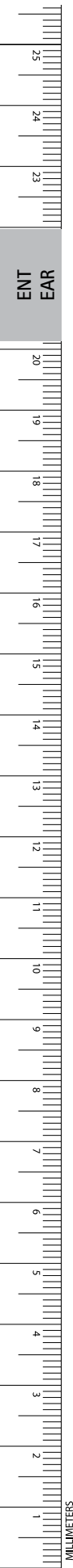
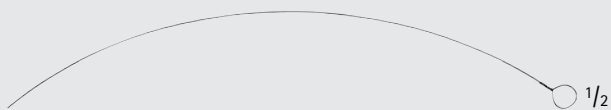

MA502R



MA503R



HOUSE-BARON Suction Tube, Long

Catalog Number	Tip Size (FR)	Working Length (in.)	Length (in.)
MA502R	3	3 5/8	5 1/2
MA503R	5	3 5/8	6 1/8

MA497R



MA498R



MA495R



MA496R

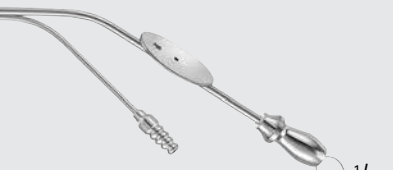

BRACKMANN Suction Tube

Catalog Number	Tip Size (FR)	Working Length (in.)	Length (in.)
MA497R	5	3	6
MA498R	7	3	6
MA495R	5	4 1/8	6
MA496R	7	4 1/8	6

MB614R-MB616R



HOUSE Suction Tube, Straight

Catalog Number	Tip	Length (in.)
MB614R	18 GA	4 1/8
MB615R	20 GA	4 1/8
MB616R	22 GA	4 1/8

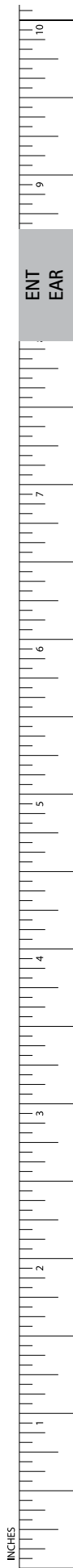

INCHES

ENT-EAR

Suction Irrigation

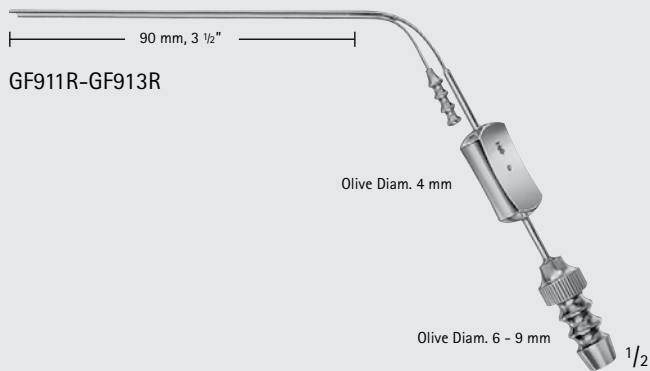

HOUSE Suction Irrigation Cannula

Catalog Number	Tip Size (mm)	Working Length (in.)
GF911R	0.9 / 0.7	3 1/2
GF912R	1.2 / 0.9	3 1/2
GF913R	1.5 / 1.2	3 1/2

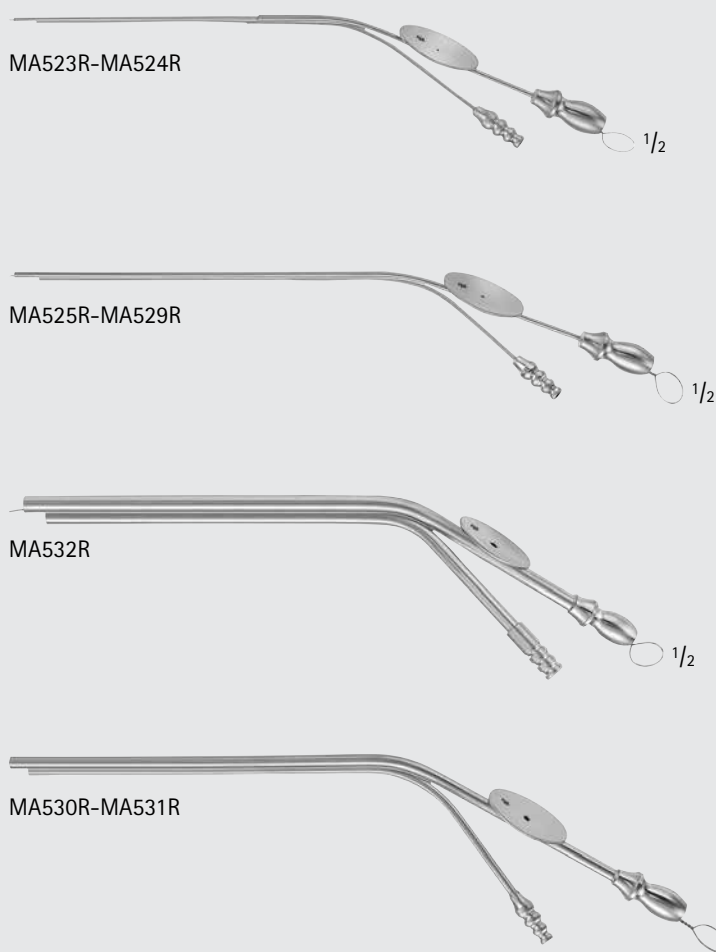

WILLIAM-HOUSE Suction Irrigator

Catalog Number	Tip Size (FR)	Working Length (in.)	Length (in.)
MA524R	2.5 x 4	2 3/4	4 1/2
MA526R	4 x 5	3	4 1/2
MA525R	2.5 x 4	3	5 1/2
MA528R	5 x 7	3	5 1/2
MA529R	6 x 8	3	5 1/2
MA530R	7 x 10	3	5 1/2
MA531R	8 x 12	3	5 1/2
MA532R	12 x 14	3	5 1/2
MA523R	2 x 2.5	3 3/8	5 1/8

ENT
EAR

MILLIMETERS

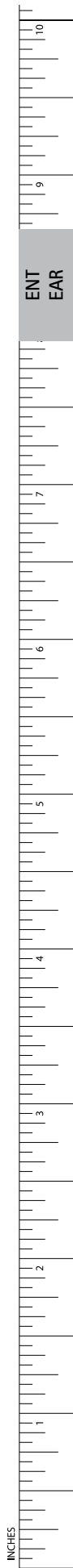

ROSEN Suction Tube

Catalog Number	Tip	Working Length (in.)	Length (in.)
MB450R	18 GA	2 3/8	3 1/2
MB451R	20 GA	2 3/8	3 1/2
MB452R	22 GA	2 3/8	3 1/2
MB453R	24 GA	2 3/8	3 1/2
MA513R	14 GA	2 3/8	4
MA514R	15 GA	2 3/8	4
MA515R	16 GA	2 3/8	4
MA516R	17 GA	2 3/8	4
MA518R	19 GA	2 3/8	4
MA522R	26 GA	2 3/8	4



MB450R-MB453R

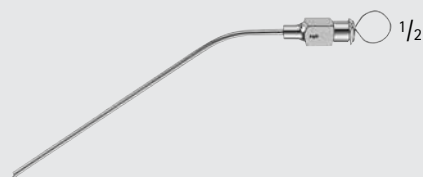

MA513R-MA522R

BELLUCCI Suction Tube, Detachable Tips

Catalog Number	Diameter (mm)	Description	Length (in.)
OG950R	-	SET	-
OG951R	8	SUCTION TUBE W/ FINGER CUT-OFF AND STYLET	6 1/8

OG950R Includes
1 Suction Tube OG951R and Stylet

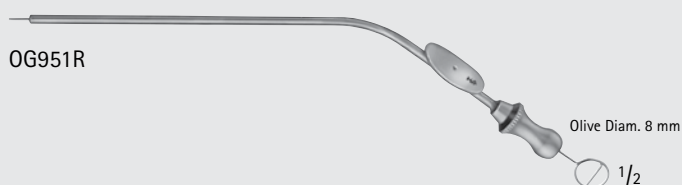

OG951R

ZOELLNER Suction, Tips Only for GF770R

Catalog Number	Tip	Diameter (mm)
GF771R	18 GA	1.2
GF772R	20 GA	1.0
GF773R	22 GA	0.7
GF774R	24 GA	0.5
GF775R	26 GA	0.4



GF771R-GF775R

ZOELLNER Suction Tube

Catalog Number	Diameter (mm)	Length (in.)
GF770R	2.5	7



GF770R

HOUSE Cut-Off Adapter

Catalog Number	Length (in.)
GF768R	2 1/4



GF768R

ENT-EAR

Dissectors/Chisels/Gouges

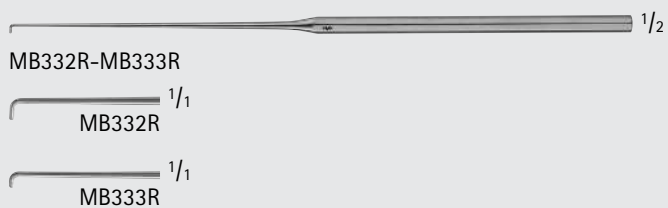

CRABTREE "JIMMY" Dissector

Catalog Number	Tip Size (mm)	Tip	Length (in.)
MB333R	1.3	SMALL	6 1/2
MB332R	2.0	LARGE	6 1/2

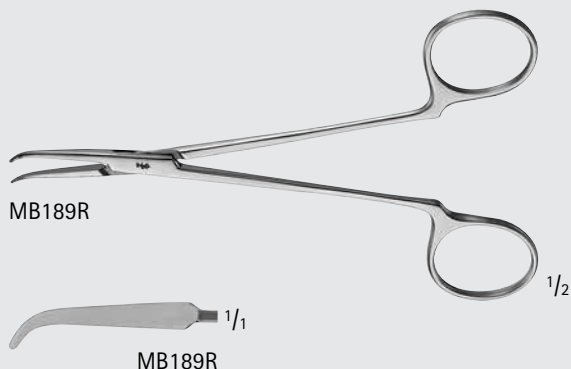

MCCABE Facial Nerve Dissector

Catalog Number	Tip Size (mm)	Jaw	Length (in.)
MB189R	25	ANG	5 1/2

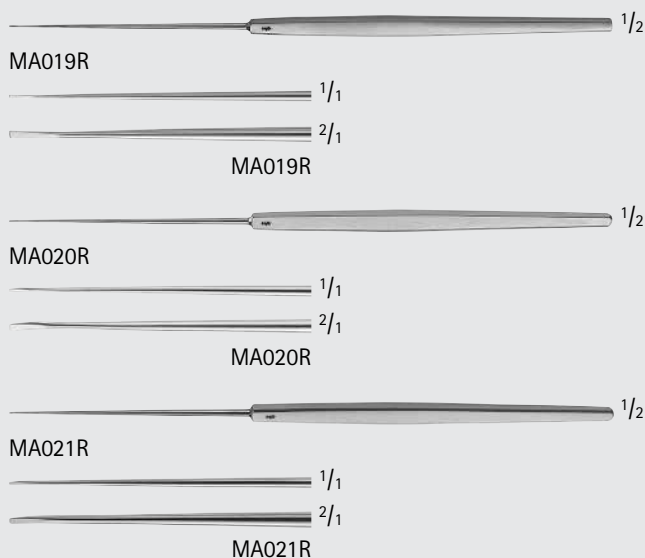

DERLACKI Chisel

Catalog Number	Tip Size (mm)	Blade Shape	Length (in.)
MA019R	0.5	STR	6 1/4
MA020R	0.5	ANG 10°	6 1/4
MA021R	0.5	ANG 20°	6 1/4

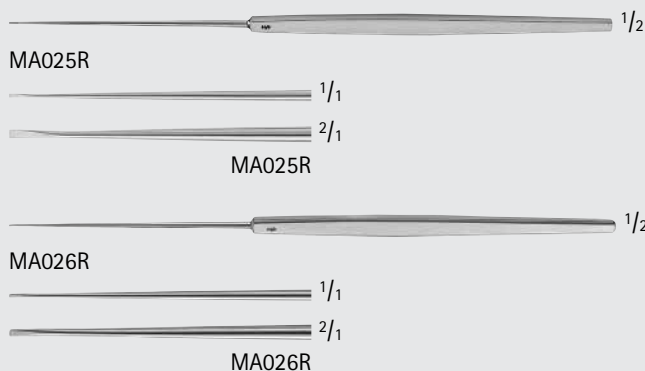

HOUSE Footplate Chisel

Catalog Number	Tip Size (mm)	Blade Shape	Length (in.)
MA025R	0.6	STR	6 1/4
MA026R	0.6	SLIGHT-CVD	6 1/4



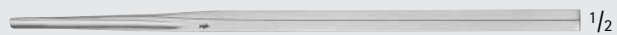

MA175R

1/2



MA176R

1/2

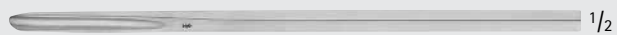

MA177R

1/2

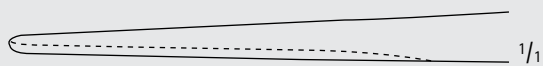

MA175R-MA177R

1/1

BISHOP Mastoid Gouge

Catalog Number	Tip Size (mm)	Length (in.)
MA175R	3	6
MA176R	4	6
MA177R	5	6



MA629R

1/2



MA629R

1/1



MB108R

1/2



MB108R

1/1

PARKES Hump Gouge, Double Guarded

Catalog Number	Tip Size (mm)	Length (in.)
MA629R	6	7
MB108R	10	7

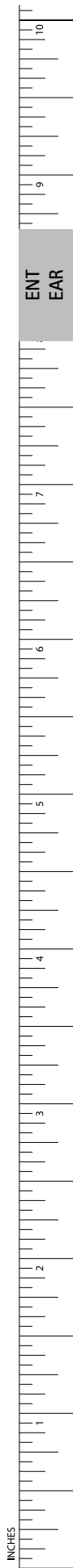

ENT-EAR

Elevators/Scrapers/Excavators

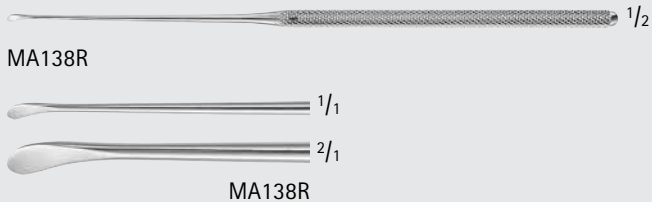

AUSTIN Duckbill Elevator

Catalog Number	Tip Size (mm)	Tip	Length (in.)
MA138R	2	CVD	6 1/4

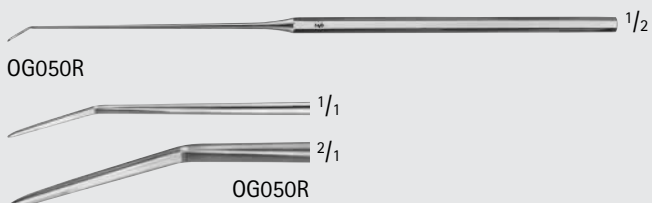

HOUSE Elevator, Angled

Catalog Number	Tip Size (mm)	Tip	Length (in.)
OG050R	1	ANG	6 1/4

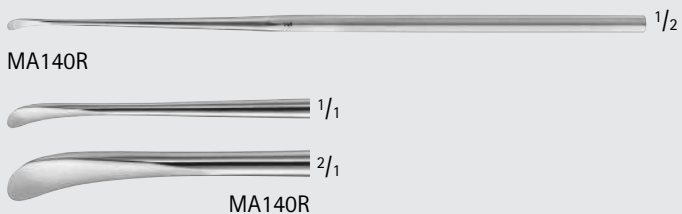

PAPARELLA Duckbill Elevator

Catalog Number	Tip Size (mm)	Size (#)	Length (in.)
MA140R	3	18	6 1/2

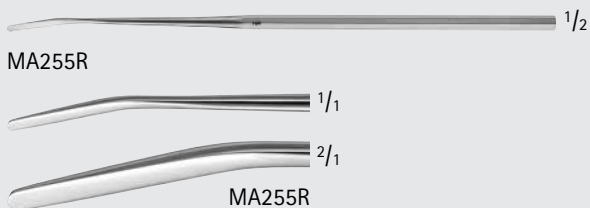

GUILFORD-WRIGHT Drum Elevator, Angled

Catalog Number	Tip Size (mm)	Length (in.)
MA255R	2	5 1/2

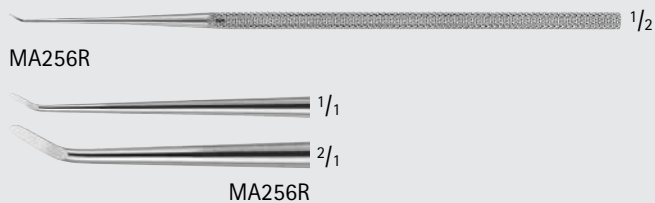

HOUGH Drum Scraper

Catalog Number	Tip Size (mm)	Tip	Length (in.)
MA256R	0.5	ANG 45°	6 1/4

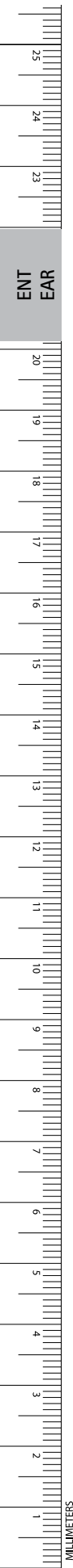

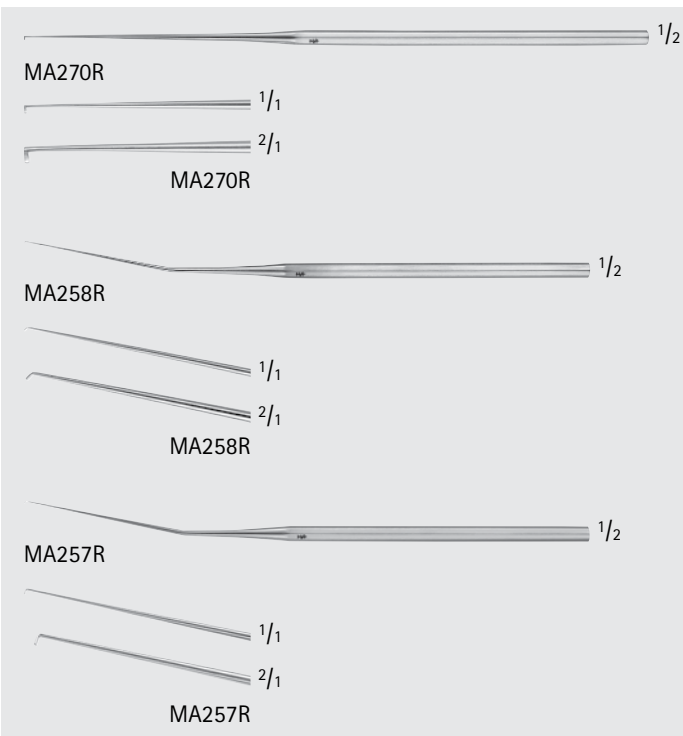

HOUGH Excavator

Catalog Number	Tip Size (mm)	Tip	Length (in.)
MA270R	0.33	ANG 30°	6 1/2
MA258R	0.33	ANG 45°	6
MA257R	0.33	ANG 90°	6

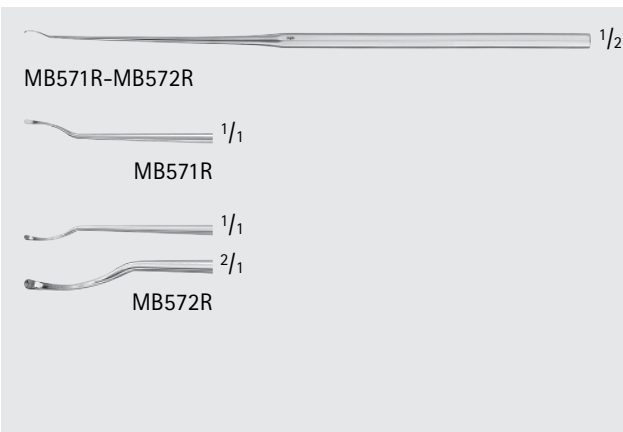

HOUGH Whirlybird Excavator

Catalog Number	Tip Size (mm)	Tip	Length (in.)
MB571R	0.7 x 3.0	CVD-LEFT	6
MB572R	0.7 x 3.0	CVD-RIGHT	6

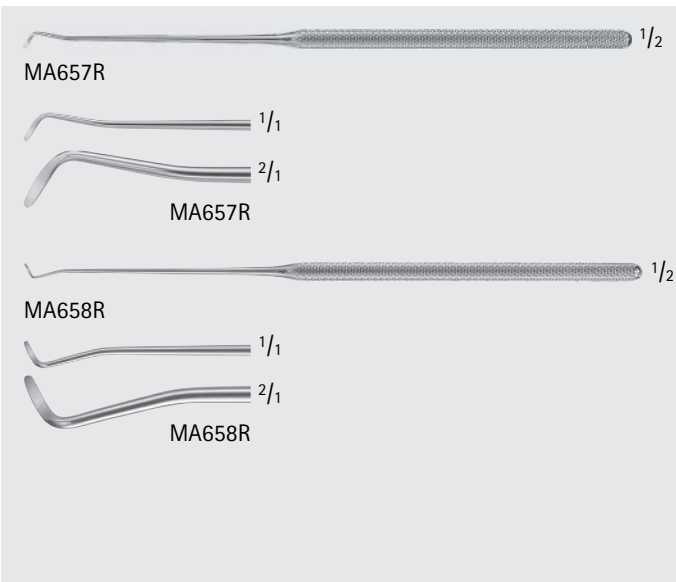

AUSTIN Excavator

Catalog Number	Tip Size (mm)	Tip	Length (in.)
MA657R	1	ANG LEFT	6 1/4
MA658R	1	ANG RIGHT	6 1/4

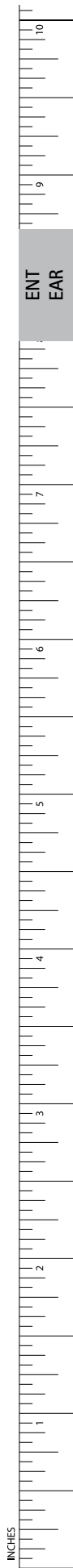

ENT-EAR

Augers/Measurers/Rasps

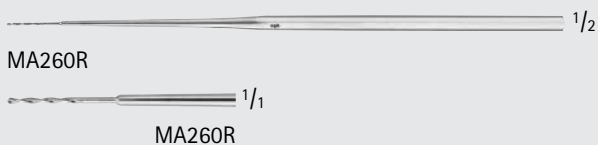

HOUGH Footplate Auger Drill

Catalog Number	Tip Size (mm)	Tip	Length (in.)
MA260R	0.8 x 20.0	DRILL	5 7/8

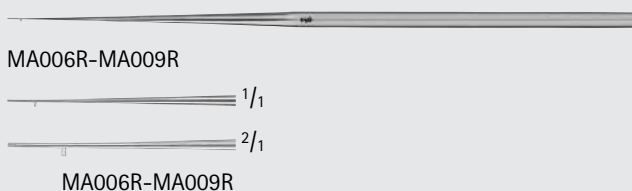

HOUSE-STRUT Measuring Rod W/ Markers

Catalog Number	Tip Size (mm)	Description	Length (in.)
MA006R	3.5	MEASURING ROD 3.5 MM FROM MARKET TO TIP	6 1/2
MA007R	4.0	MEASURING ROD 4.0 MM FROM MARKET TO TIP	6 1/2
MA008R	4.5	MEASURING ROD 4.5 MM FROM MARKET TO TIP	6 1/2
MA009R	5.0	MEASURING ROD 5.0 MM FROM MARKET TO TIP	6 1/2

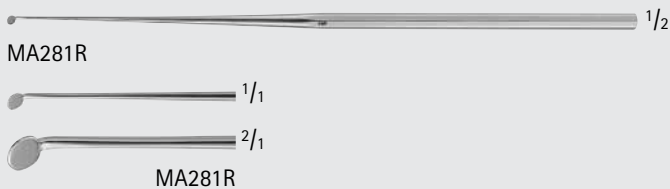

Middle Ear Mirror

Catalog Number	Diameter (mm)	Tip	Length (in.)
MA281R	2	ANG 45°	6 1/2

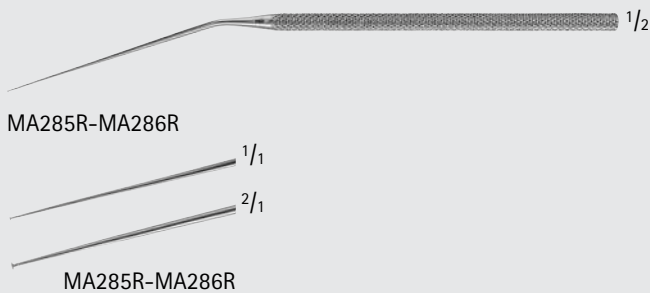

MCGEE Oval Window Rasp

Catalog Number	Size	Length (in.)
MA285R	SMALL	6 3/8
MA286R	LARGE	6 3/8

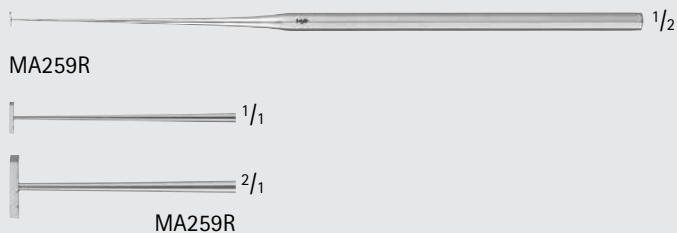

PAPARELLA Fenestrometer

Catalog Number	Blade Size (mm)	Tip Size (#)	Length (in.)
MA259R	1 x 4	13	6 3/8

ENT
EAR

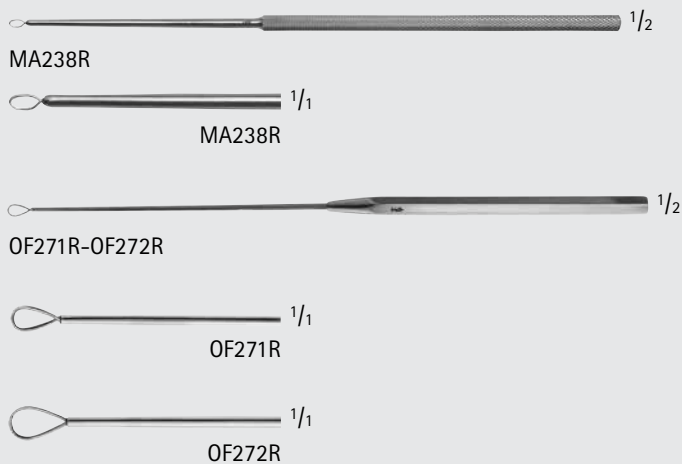

BILLEAU Ear Loop

Catalog Number	Tip Size (mm)	Tip	Length (in.)
MA238R	2	SMALL	6 3/8
OF271R	2	MEDIUM	6 1/4
OF272R	3	LARGE	6 1/4

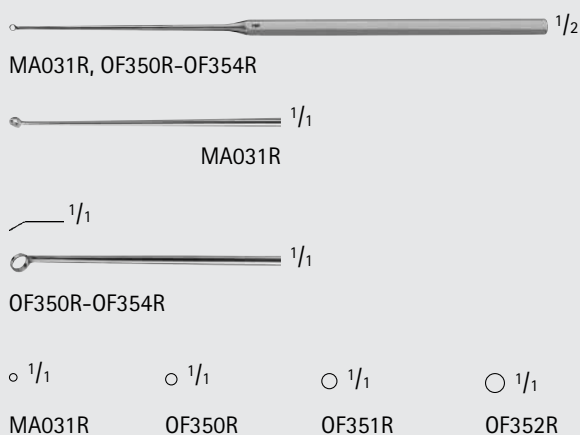

BUCK Ear Curette, Sharp, Curved

Catalog Number	Tip Size (#)	Cup Size (mm)	Length (in.)
MA031R	00	1.0	6
OF350R	00	1.5	6
OF351R	0	2.0	6
OF352R	1	2.5	6
OF353R	2	3.0	6
OF354R	3	4.0	6

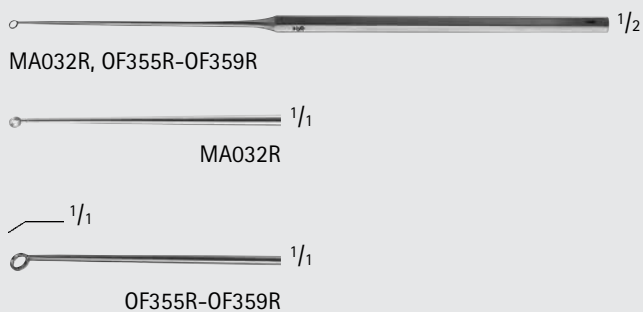

BUCK Ear Curette, Blunt, Curved

Catalog Number	Tip Size (#)	Cup Size (mm)	Length (in.)
MA032R	00	1.0	6
OF355R	00	1.5	6
OF356R	0	2.0	6
OF357R	1	2.5	6
OF358R	2	3.0	6
OF359R	3	4.0	6

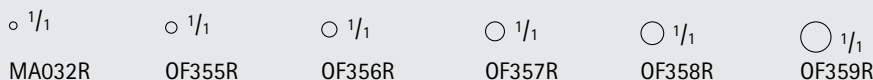

ENT-EAR

Curettes/Loops/Spoons



MA252R

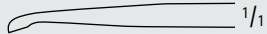

MA252R

HOUGH Ear Curette

Catalog Number	Cup Size (mm)	Tip	Size	Length (in.)
MA252R	2.25 x 3 SERR	ANG 30°	LARGE	5 5/8



MB039R



MB039R



MA279R



MA279R

GUILFORD-WRIGHT Ear Curette, Angled

Catalog Number	Cup Size (mm)	Size	Length (in.)
MB039R	2.4 x 1.4	SMALL	5 1/8
MA279R	2.5 x 3.0	MEDIUM	5 1/4



MA055R



MA055R

SHEA Ear Curette, Round

Catalog Number	Cup Size (mm)	Blade	Length (in.)
MA055R	2	ANG	5 1/2



MA053R-MA054R



MA053R-MA054R

SHAPLEIGH Ear Curette, Angled

Catalog Number	Tip Size (mm)	Tip	Size	Length (in.)
MA053R	1.5	SERR	SMALL	6 1/2
MA054R	2.0	SERR	LARGE	6 1/2

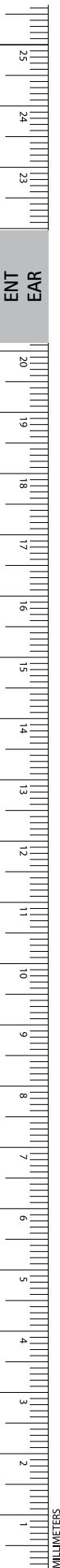



FREIMUTH Ear Curette

Catalog Number	Cup Size (mm)	Tip	Size	Length (in.)
MA653R	2.5 x 4	SERR	SMALL	6 1/4

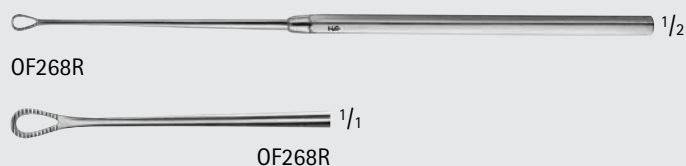

SNELLEN Ear Curette

Catalog Number	Tip	Blade	Length (in.)
OF268R	SERR	CVD	6 1/4



Ear Curette, Pointed, Double Ended

Catalog Number	Cup Size	Length (in.)
OG189R	LARGE	6 3/4

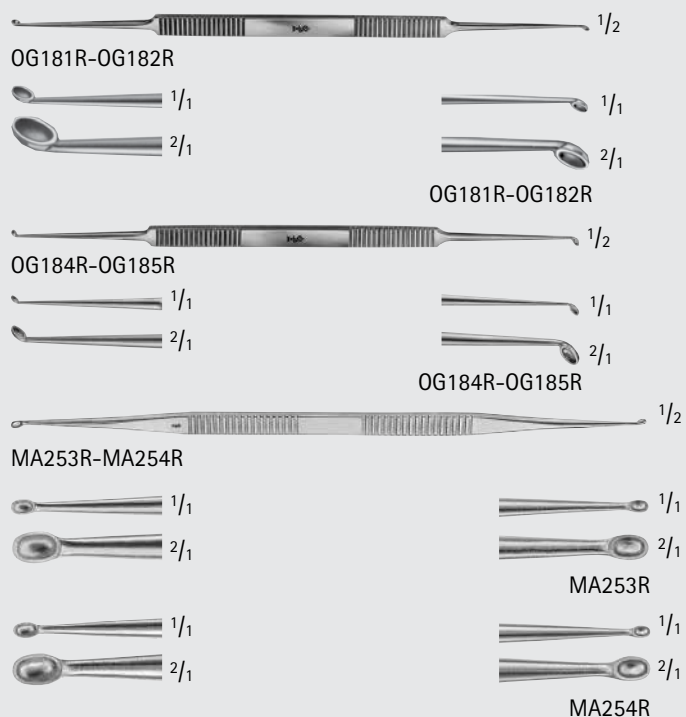

HOUSE Ear Curette, Double Ended

Catalog Number	Cup Size (mm)	Tip	Length (in.)
OG181R	1.0 / 1.2	ANG	6
OG182R	1.5 / 1.8	ANG	6
OG184R	1.0 / 1.2	STRONG ANG	6
OG185R	1.5 / 1.8	STRONG ANG	6
MA253R	2.0 / 1.7	LIGHT ANG	7
MA254R	2.0 / 2.25	STRONG ANG	7

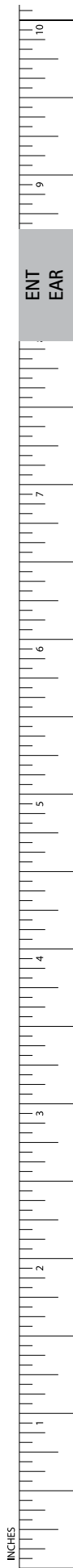

ENT-EAR

Curettes/Loops/Spoons



MA035R



MA035R

HOUSE-PAPARELLA Stapes Ear Curette, Double Ended

Catalog Number	Cup Size (mm)	Length (in.)
MA035R	1.6 x 3.0 / 2.0 x 3.5	6 1/4



MA036R



MA036R

HOUSE Stapes Curette, Double Ended

Catalog Number	Cup Size (mm)	Length (in.)
MA036R	1.8 x 2.5 / 1.5 x 2.4	6



OG180R

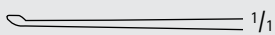

OG180R

SHEA Bone Curette, Oval

Catalog Number	Cup Size (mm)	Blade	Length (in.)
OG180R	1.5 x 2.5	STR	6 1/4

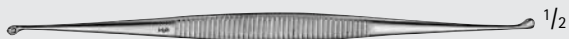

FK800R

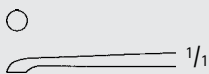

FK800R



FK801R



FK801R

MARTINI Bone Curette, Double Ended

Catalog Number	Cup Size (mm)	Length (in.)
FK800R	3.0 / 3.2	5 1/2
FK801R	4.0 / 3.2	5 1/2

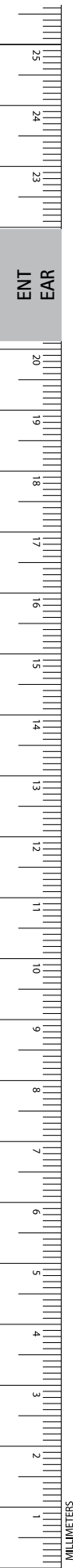

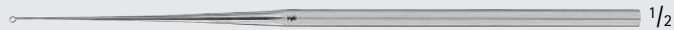

MA051R

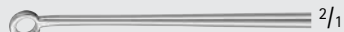
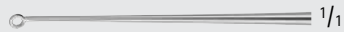

MA051R

PAPARELLA Ring Curette

Catalog Number	Cup Size (#)	Blade	Length (in.)
MA051R	12	ANG	6 1/2



MB117R



1/1

MB117R

PRATT Ethmoid Curette, Double Ended

Catalog Number	Blade	Length (in.)
MB117R	SOLID/FENESTRATED	9 1/4



MA188R



MA188R

GROSS Ear Hook/Spoon, Double Ended

Catalog Number	Hook	Spoon	Length (in.)
MA188R	90° BLUNT 2.6 MM	3.2 x 7.5 MM	5 1/4

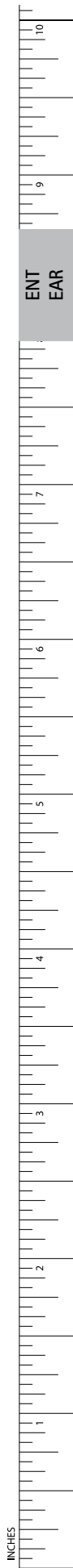

INCHES

ENT-EAR

Rongeurs



MA439R-MA442R

KERRISON Mastoid Rongeur, 90° Up

Catalog Number	Tip Size (#)	Jaw Size (mm)	Working Length (in.)	Length (in.)
MA439R	0	3.5 x 9	4 1/8	6 3/4
MA440R	1	4.0 x 9	4 1/8	6 3/4
MA441R	2	4.5 x 9	4 1/8	6 3/4
MA442R	3	5.0 x 9	4 1/8	6 3/4



MA439R



MA440R



MA441R



MA442R

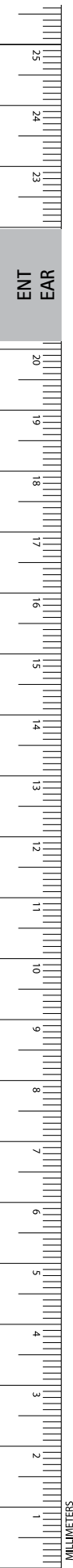

ENT-EAR Tuning Forks



OF001N-OF006N

HARTMANN Tuning Fork

Catalog Number	Frequency
MB575A	c 64
OF001N	c 128
OF002N	c1 256
OF003N	c2 512
OF004N	c3 1024
OF005N	c4 2048
OF006N	c5 4096



MB575A

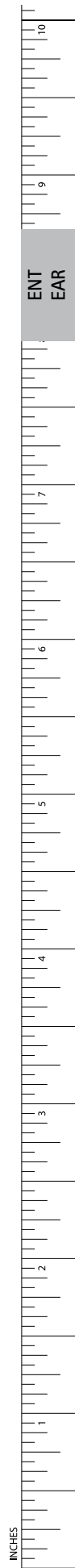

ENT-EAR

Miscellaneous

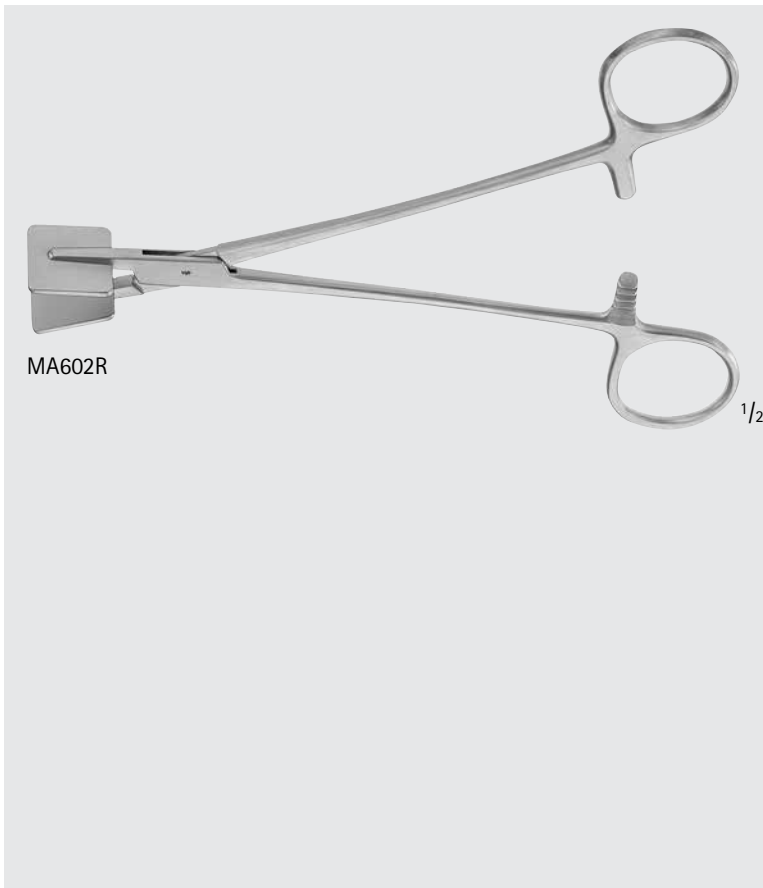
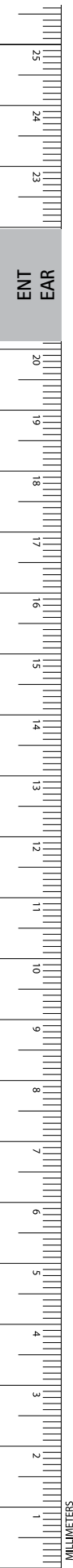

SHEEHY Fascia Press

Catalog Number	Jaw Size (mm)	Jaw	Description	Length (in.)
MA602R	23 x 31	PLATE	W/ RATCHET BOX LOCK	7 1/2

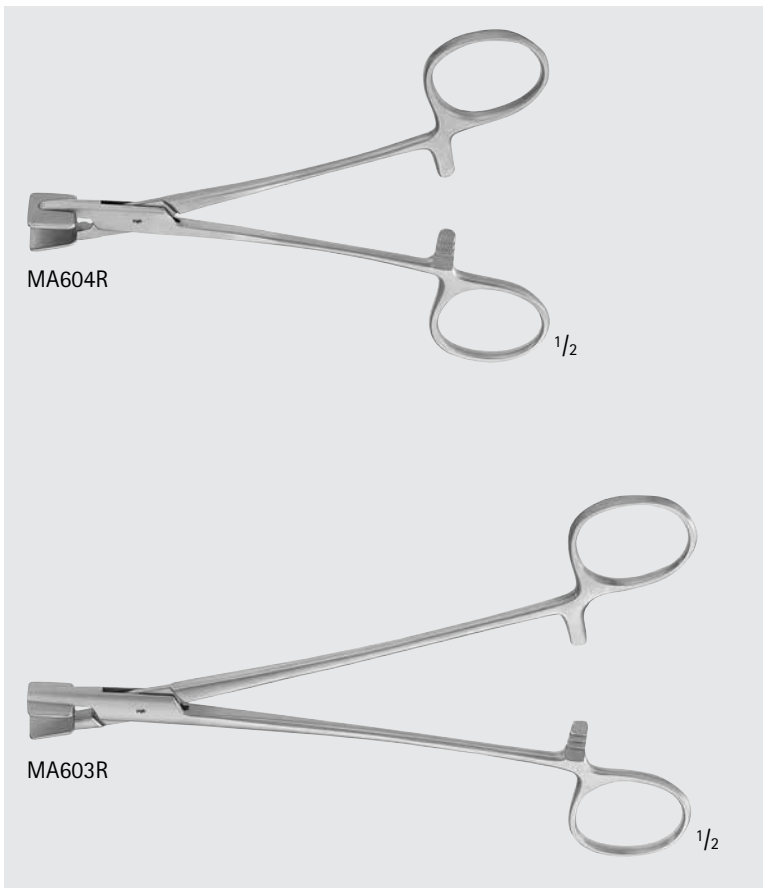

HOUSE Gelfoam Press, with Ratchet

Catalog Number	Jaw Size (mm)	Jaw	Length (in.)
MA604R	12 x 15	PLATE	5 3/8
MA603R	12 x 16	PLATE	7



MA605R

HOUSE Cutting Block, Delrin

Catalog Number	Dimensions (mm)	Description	Length (in.)
MA605R	8 x 38	AUTOCLAVABLE	2 7/8



OG145R

Surgery Preparation Base W/ mm Scale

Catalog Number	Dimensions (mm)
OG145R	92 x 54

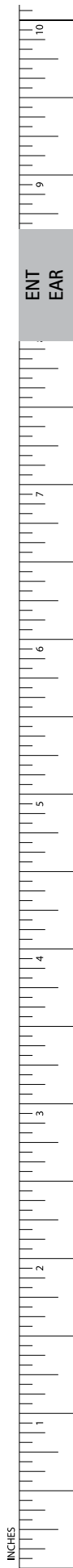

INCHES

ENT-EAR

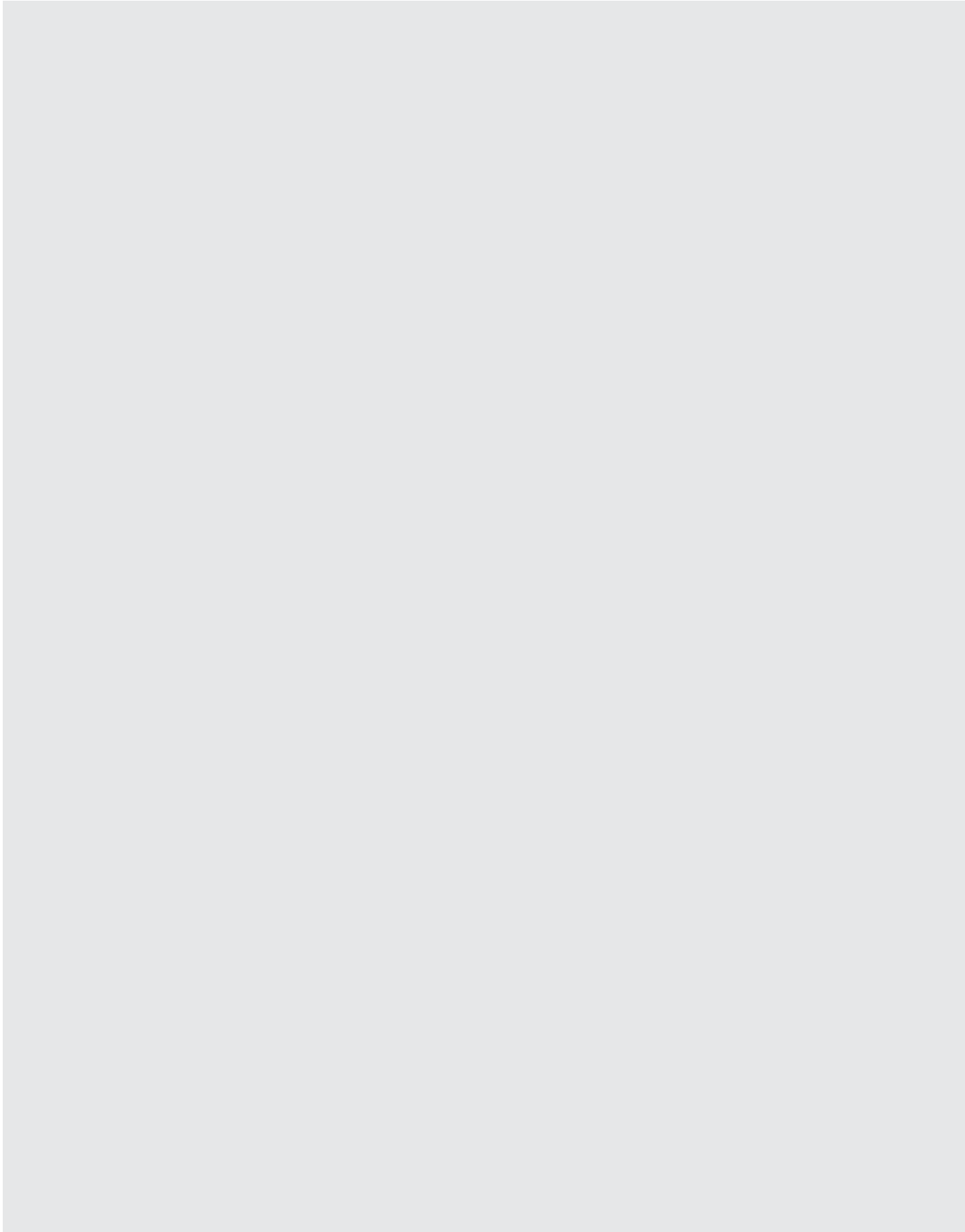
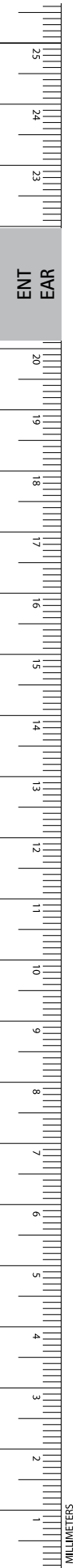



ENT-Nasal

Scissors	596 - 614
Trocar, Needles and Needle Holders	615 - 617
Forceps	618 - 649
Nasal Snares and Wires	650
Hooks	651
Retractors	652 - 657
Elevators and Dissectors	658 - 664
Specula	665 - 673
Rasps, Files and Saws	674 - 677
Chisels and Gouges	678 - 679
Osteotomes	680 - 685
Applicators and Probes	686
Knives	687 - 688
Suction and Irrigation	689 - 692
Mallets, Hammers and Tamps	693 - 694
Curettes	695 - 698
Rongeurs	699 - 703

ENT-NASAL

Scissors

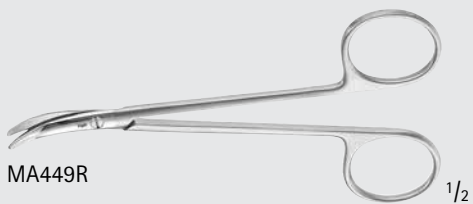

MA449R

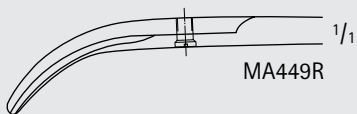

MA449R

CINELLI Lower Lateral Scissors

Catalog Number	Blade	Length (in.)
MA449R	STRONG CVD	4 3/8

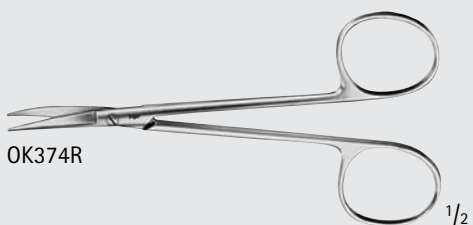

OK374R

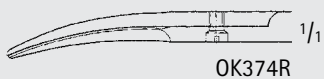

OK374R

COTTLE Bulldog Scissors

Catalog Number	Tip	Blade	Length (in.)
OK374R	B/B	CVD	4 1/2

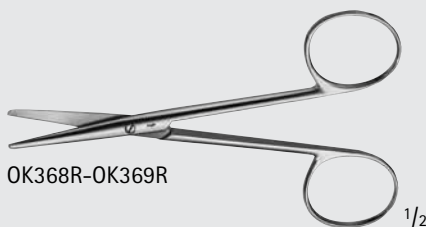

OK368R-OK369R

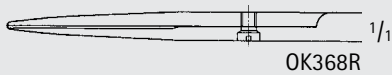

OK368R

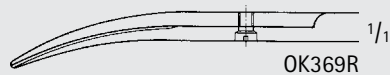

OK369R

COTTLE-KNAPP Plastic Scissors

Catalog Number	Tip	Blade	Length (in.)
OK368R	B/B	STR	4 1/8
OK369R	B/B	CVD	4 1/8

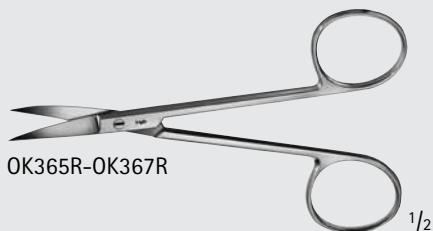

OK365R-OK367R

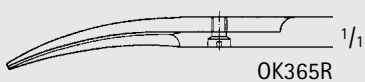

OK365R

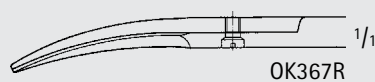

OK367R

COTTLE-MASING Plastic Scissors

Catalog Number	Tip	Blade	Length (in.)
OK365R	S/S	CVD	4 1/8
OK367R	B/B	CVD	4 1/8

ENT
NASAL

DAVIS Rhytidectomy Scissors

Catalog Number	Blade	Length (in.)
MA450R	CVD	6 3/4

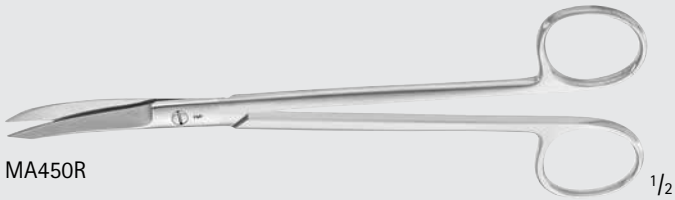

MA450R

1/2

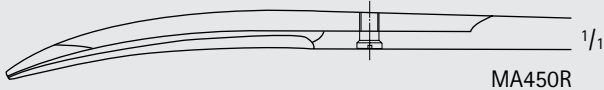

MA450R

1/1

Rhinoplasty Scissors

Catalog Number	Tip	Blade	Length (in.)
MG086R	B/B	FLAT, CVD	5 1/4

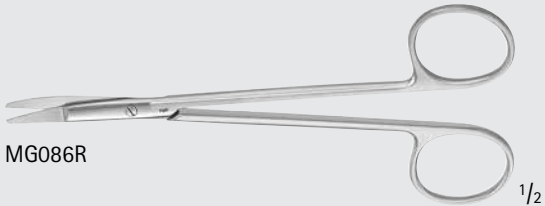

MG086R

1/2

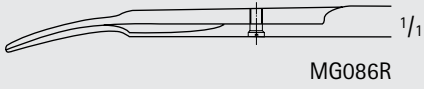

MG086R

1/1

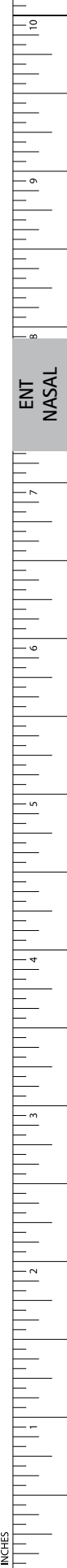

ENT-NASAL

Scissors

MA335R-MA337R



MA335R $\frac{1}{1}$

MA336R $\frac{1}{1}$

MA337R $\frac{1}{1}$

Nasal Scissors, Pediatric

Catalog Number	Blade	Blade Size (mm)	Length (in.)
MA335R	STR	6	4
MA336R	CVD-RIGHT	5.5	4
MA337R	CVD-LEFT	5.5	4

MA318R, MA600R, MA599R

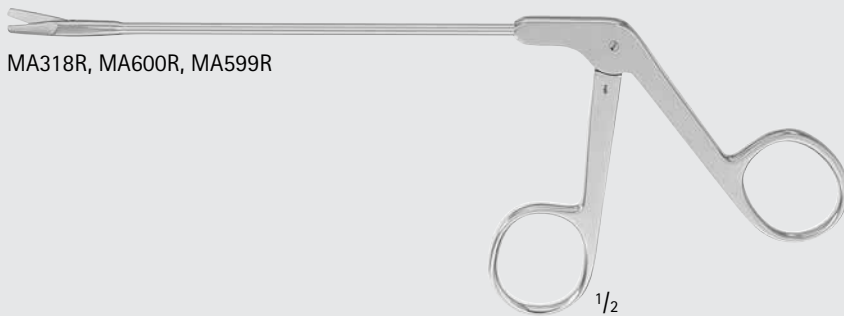

MA318R $\frac{1}{1}$

MA600R $\frac{1}{1}$

MA599R $\frac{1}{1}$

Nasal Scissors, Adult

Catalog Number	Blade	Blade Size (mm)	Working Length (in.)
MA318R	STR	11	5 1/8
MA600R	RIGHT	11	5 1/8
MA599R	LEFT	11	5 1/8

ENT
NASAL

MILLIMETERS



MA609R

1/2

LAKESIDE Nasal Scissors

Catalog Number	Blade	Length (in.)
MA609R	STR	7 1/4

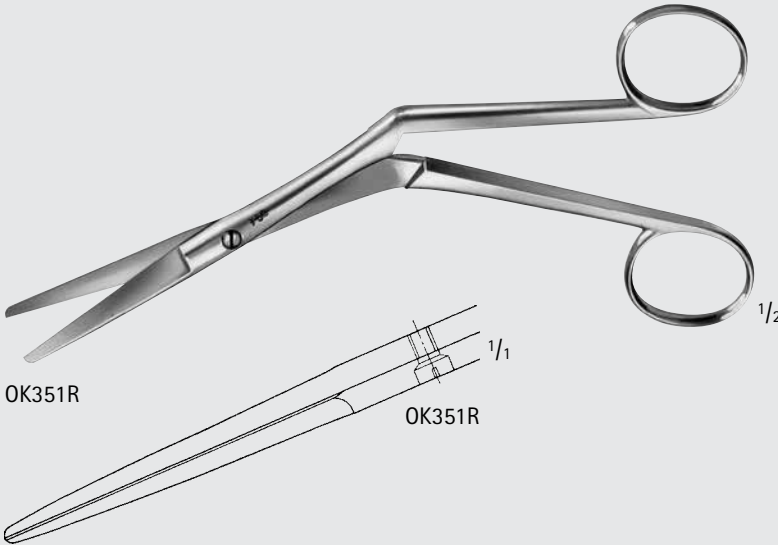

OK351R

1/2

OK351R

1/1

HEYMANN Nasal Scissors

Catalog Number	Tip	Blade	Length (in.)
OK351R	B/B	STR	7 1/2

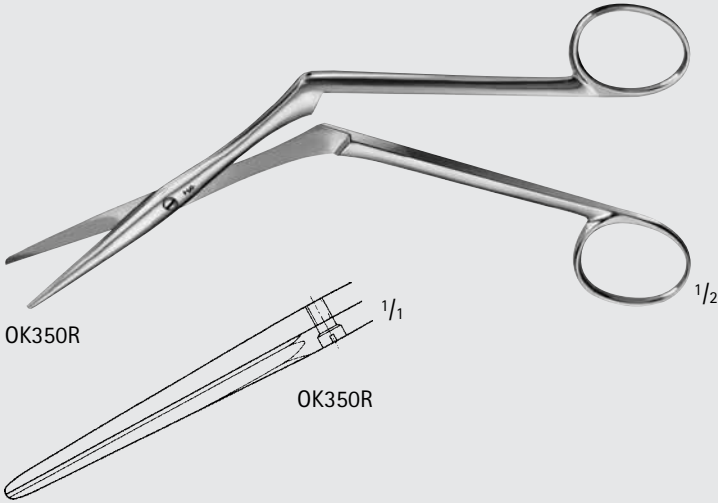

OK350R

1/2

OK350R

1/1

HEYMANN-KNIGHT Nasal Scissors

Catalog Number	Tip	Blade	Length (in.)
OK350R	B/B	STR	6 7/8



INCHES

ENT-NASAL

Scissors

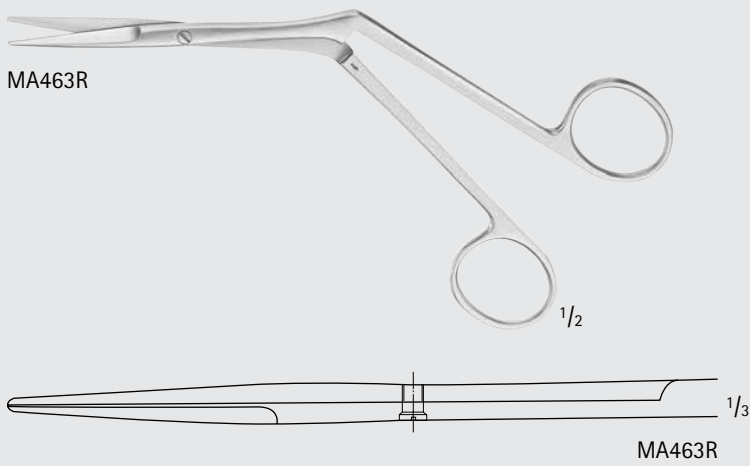

KNIGHT Nasal Scissors, Lightweight, Delicate

Catalog Number	Blade	Tip	Length (in.)
MA463R	STR	DEL	6 3/8

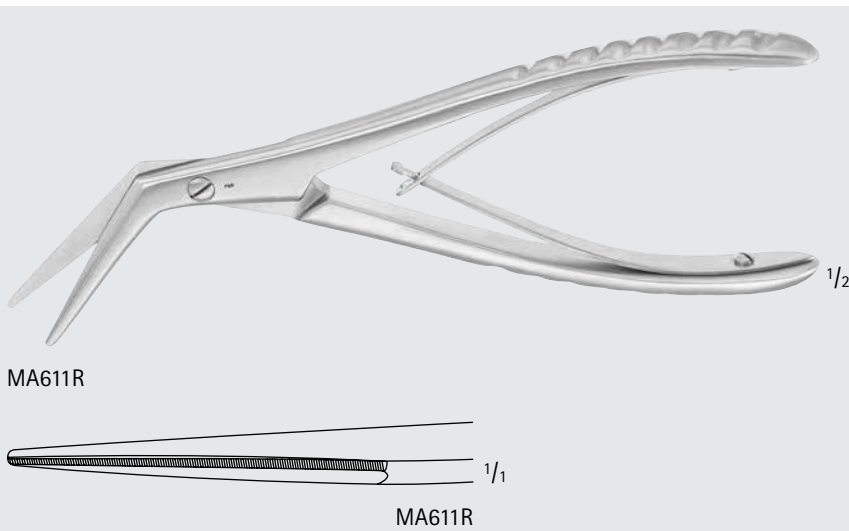

JACKSON Nasal Bone Scissors

Catalog Number	Blade	Length (in.)
MA611R	ANG	8 1/2

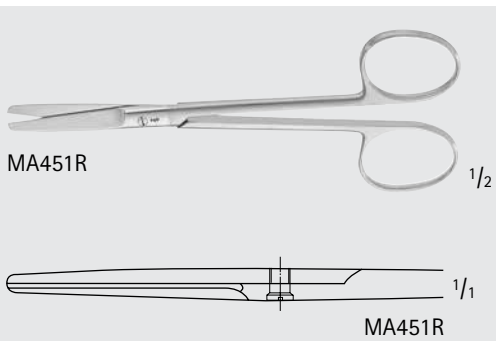

Dorsal Scissors

Catalog Number	Tip	Blade	Length (in.)
MA451R	BLUNT	STR	4 3/4

ENT
NASAL

MILLIMETERS

FOMON Dorsal Scissors

Catalog Number	Tip	Blade	Handle	Length (in.)
MA452R	B/B	SERR	ANG	5 3/4
OK370R	B/B	SERR	ANG	5 3/4

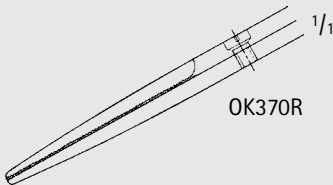
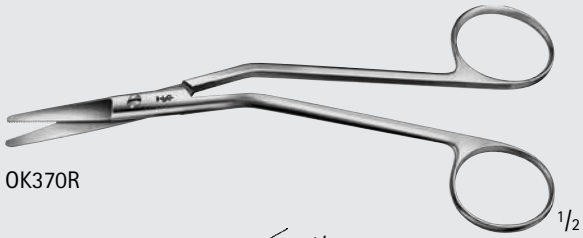
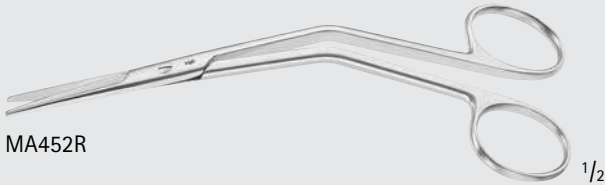

FOMON Lower Lateral Scissors

Catalog Number	Tip	Blade	Length (in.)
OK373R	B/B	HEAVY-CVD	4 1/2
OK372R	B/B	HEAVY-CVD	5 1/4

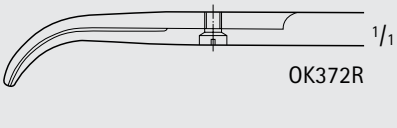
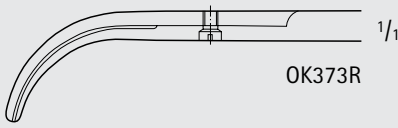
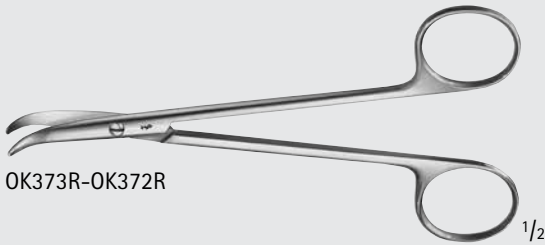

FOMON Saber-Back Scissors

Catalog Number	Tip	Blade	Length (in.)
MB140R	B/B	CVD, SERR	5



ENT-NASAL

Scissors

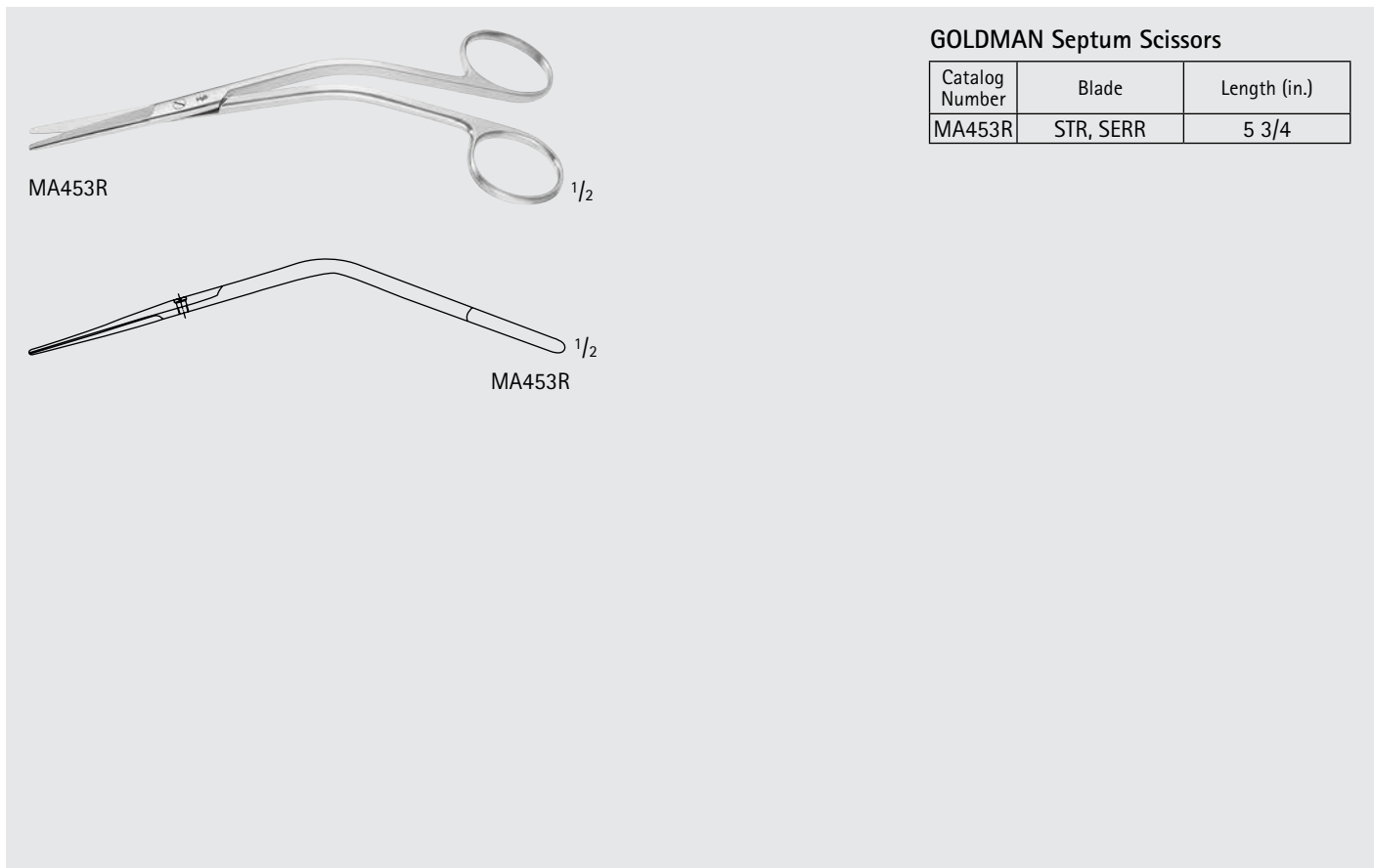
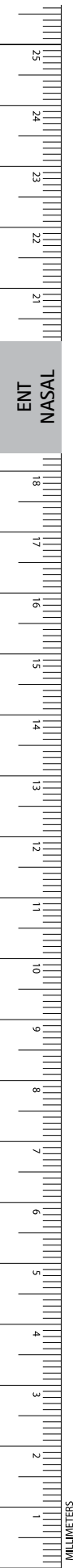

GOLDMAN Septum Scissors

Catalog Number	Blade	Length (in.)
MA453R	STR, SERR	5 3/4

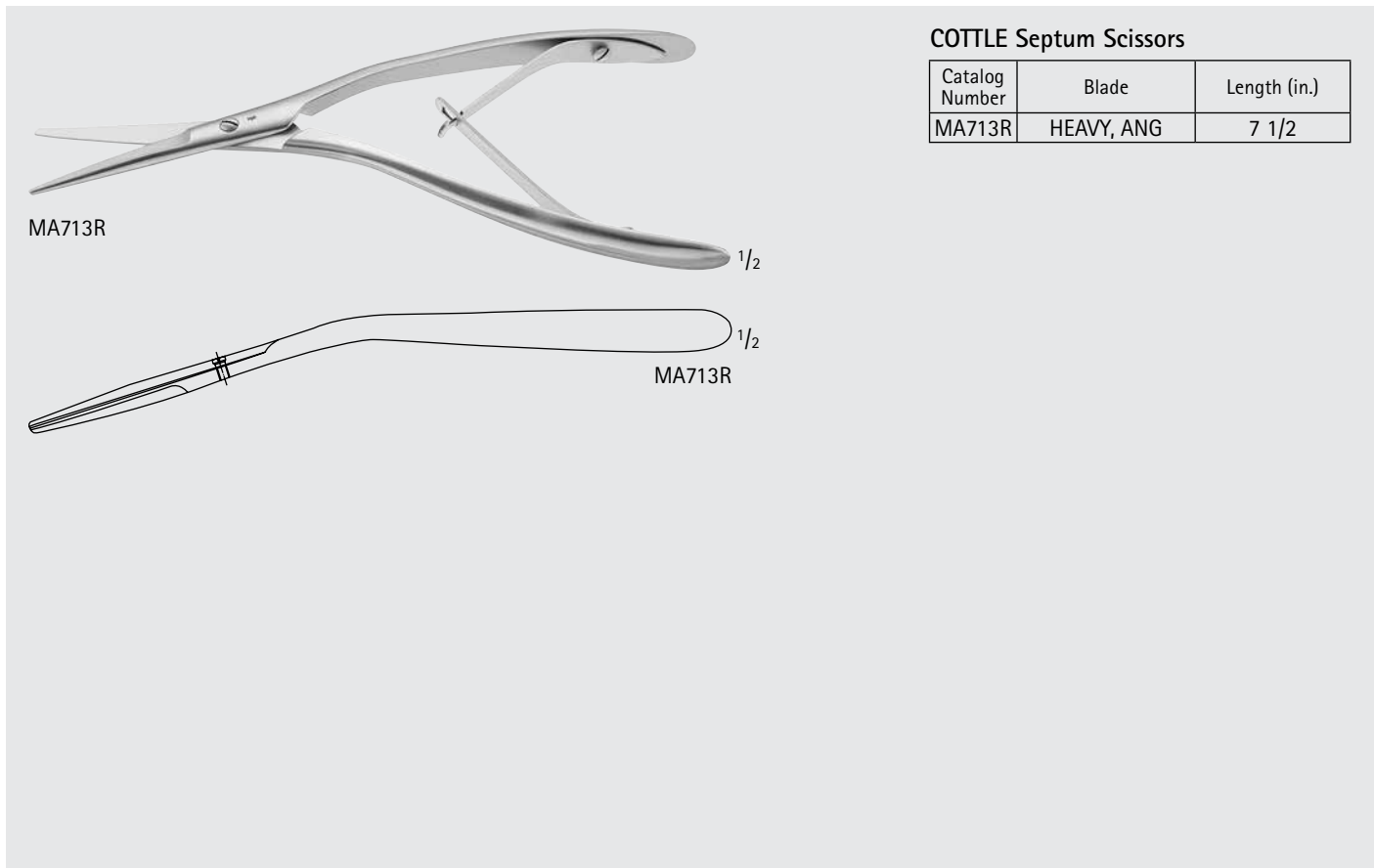

COTTLE Septum Scissors

Catalog Number	Blade	Length (in.)
MA713R	HEAVY, ANG	7 1/2

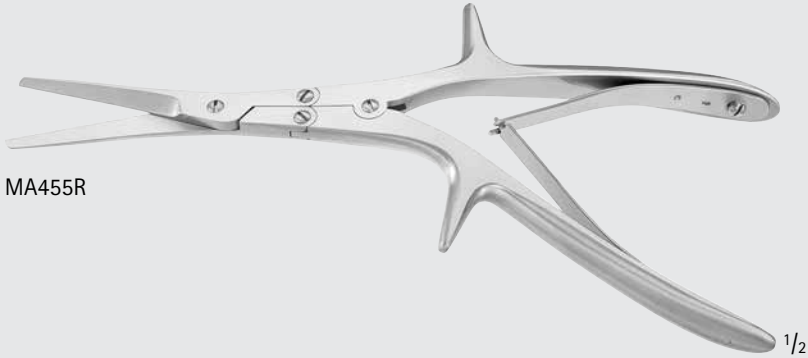

MA455R

1/2



1/2

MA455R

GORNEY Turbinate Scissors, Double Action

Catalog Number	Jaw	Length (in.)
MA455R	SERR	8

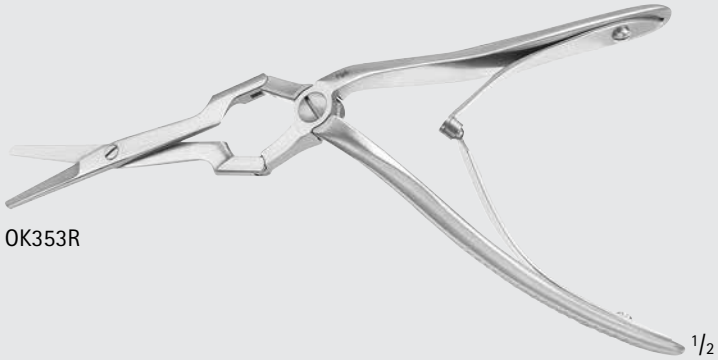

OK353R

1/2



1/1

OK353R

Becker Septum Scissors, Double Joint

Catalog Number	Blade	Length (in.)
OK353R	SERR	7

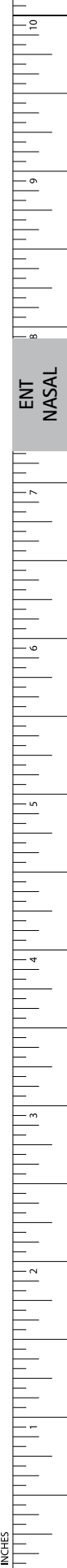

INCHES

ENT-NASAL

Scissors

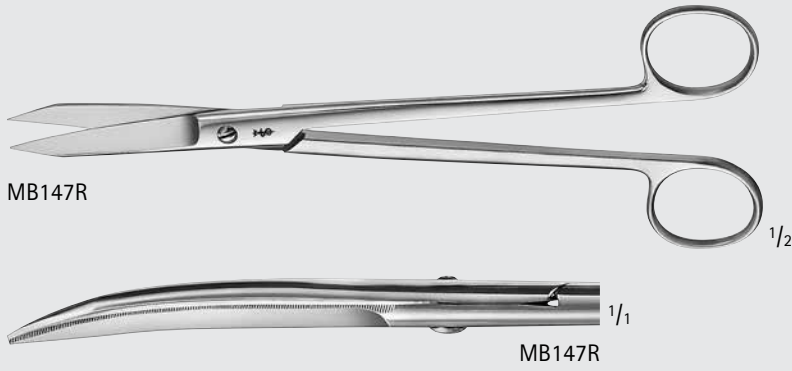

MARTIN Cartilage Scissors

Catalog Number	Blade	Length (in.)
MB147R	CVD, SERR	8

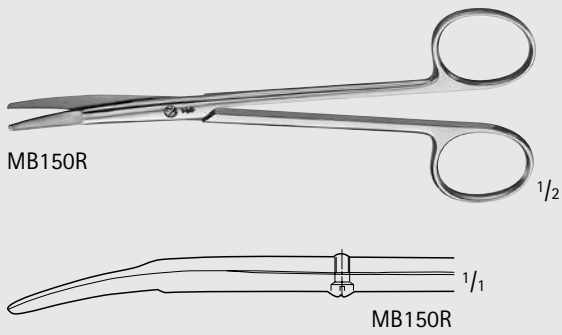

METZENBAUM-LIPSETT Scissors

Catalog Number	Tip	Blade	Length (in.)
MB150R	B/B	CVD	5 1/2

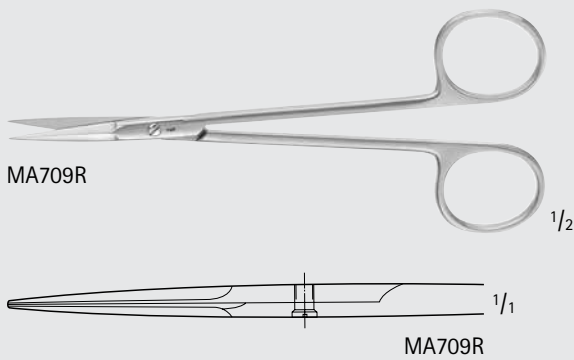

PECK-JOSEPH Scissors

Catalog Number	Blade	Tip Size (mm)	Length (in.)
MA709R	STR, SHARP	42	5 3/4

ENT
NASAL

MILLIMETERS

JOSEPH Scissors, Delicate

Catalog Number	Tip	Blade	Handle	Length (in.)
MB174R	S/S	STR, SERR	ROUND	5 1/2
MB175R	S/S	CVD, SERR	ROUND	5 1/2
BC156R	S/S	STR	ROUND	6
BC157R	S/S	CVD	ROUND	6
BC006R	S/S	STR	SQUARE	6
BC007R	S/S	CVD	SQUARE	6

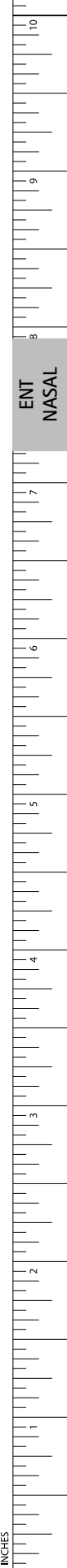
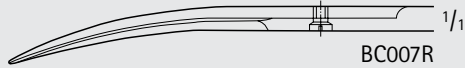
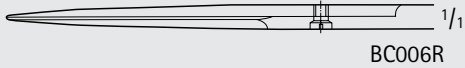
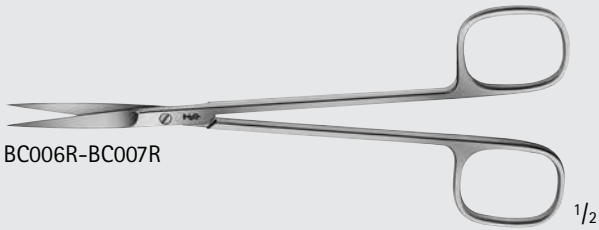
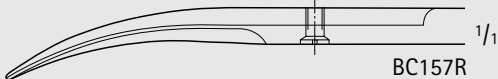
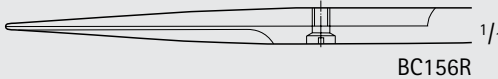
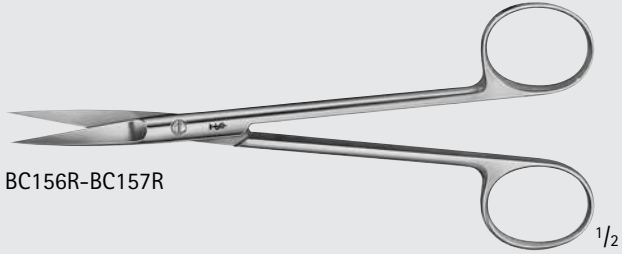
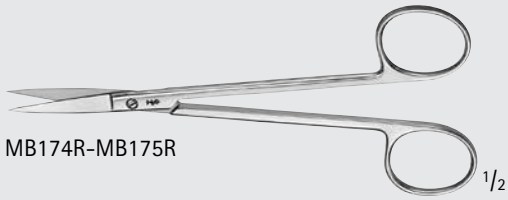

ENT-NASAL

Scissors

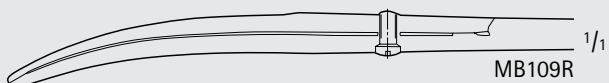
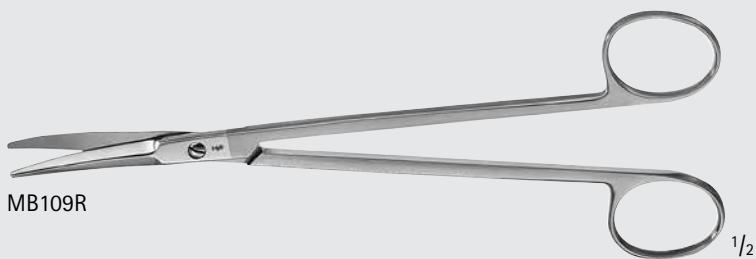
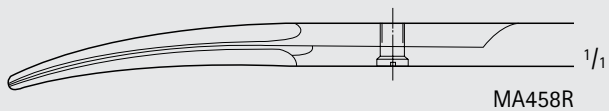
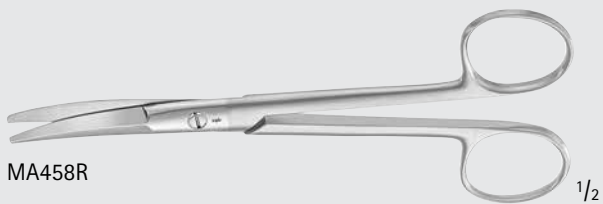

KAYE Facelift Scissors

Catalog Number	Tip	Blade	Length (in.)
MA458R	SEMI-SHARP	CVD, SERR	6
MB109R	SEMI-SHARP	CVD, SERR	7 1/2

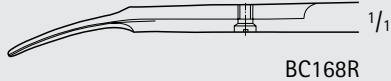
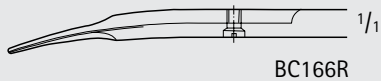
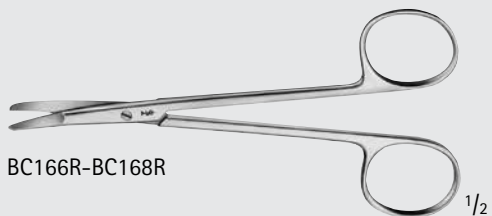

KILNER Scissors

Catalog Number	Tip	Blade	Length (in.)
BC166R	FLAT	CVD	5
BC168R	FLAT	CVD	6

ENT
NASAL

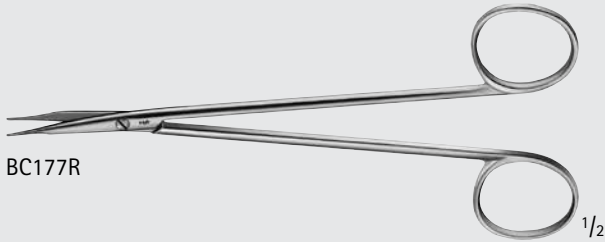

BC177R

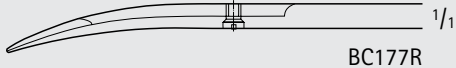

BC177R

JAMESON Tenotomy Scissors, Delicate

Catalog Number	Tip	Blade	Length (in.)
BC177R	B/B	CVD	6

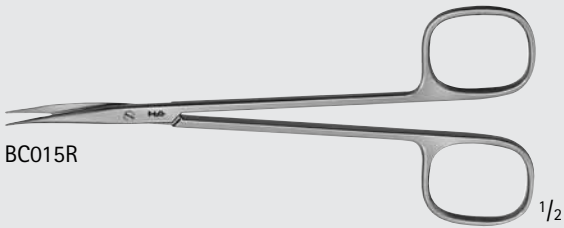

BC015R

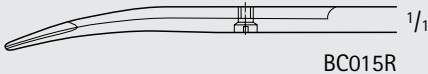

BC015R

REYNOLDS-JAMESON Tenotomy Scissors, Delicate

Catalog Number	Tip	Blade	Handle	Length (in.)
BC015R	B/B	CVD	SQUARE	5 1/2

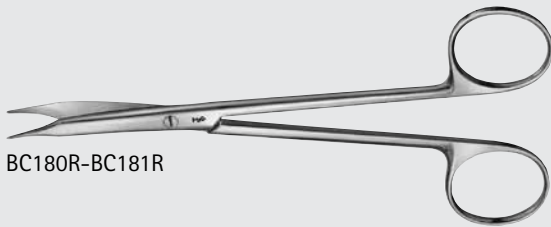

BC180R-BC181R

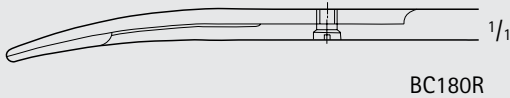

BC180R

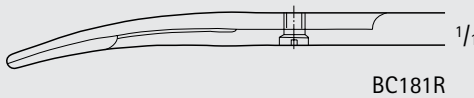

BC181R

REYNOLDS Tenotomy Scissors, Delicate

Catalog Number	Tip	Blade	Length (in.)
BC180R	B/B	CVD	5 3/4
BC181R	B/B	CVD	6 7/8

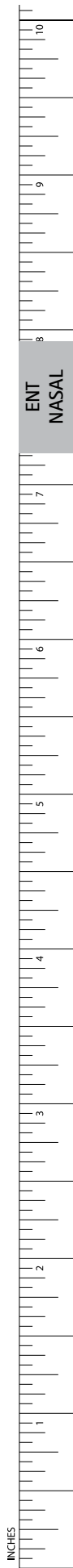

INCHES

ENT-NASAL

Scissors

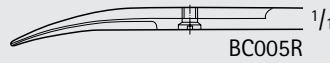
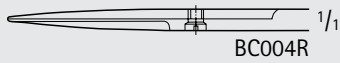
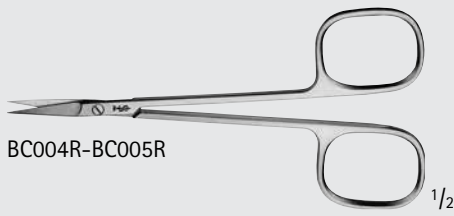

Iris Scissors, Delicate

Catalog Number	Tip	Blade	Handle	Length (in.)
BC004R	S/S	STR	SQUARE	4 1/2
BC005R	S/S	CVD	SQUARE	4 1/2

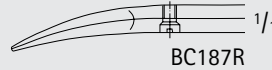
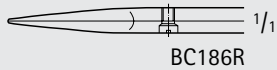
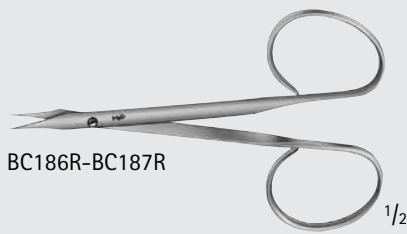

STEVENS Tenotomy Scissors, Delicate

Catalog Number	Tip	Blade	Handle	Length (in.)
BC186R	S/S	STR	RIBBON	4
BC187R	S/S	CVD	RIBBON	4
OK366R	B/B	CVD	RIBBON	4 1/4

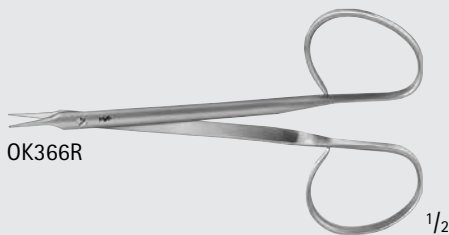

STEVENS Tenotomy Scissors, Delicate

Catalog Number	Tip	Blade	Handle	Length (in.)
BC008R	S/S	STR	SQUARE	4 1/2
BC010R	B/B	STR	SQUARE	4 1/2
BC009R	S/S	CVD	SQUARE	4 1/2
BC011R	B/B	CVD	SQUARE	4 1/2

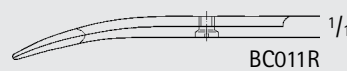
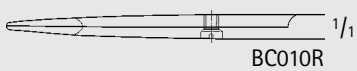
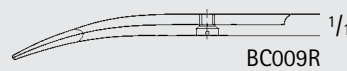
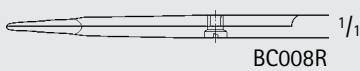
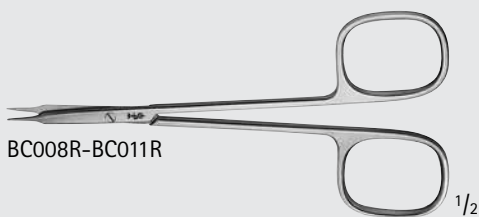

ENT
NASAL

MILLIMETERS



BC170R-MA467R



BC170R

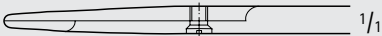

BC172R

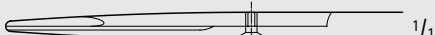

BC194R



MA467R



BC171R-MA466R



BC171R

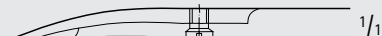

BC173R

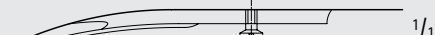

BC195R

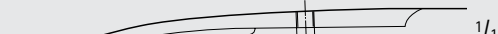

MA466R

STEVENS Tenotomy Scissors

Catalog Number	Tip	Blade	Handle	Length (in.)
BC170R	S/S	STR	ROUND	4 1/4
BC172R	B/B	STR	ROUND	4 1/4
BC194R	B/B	STR	ROUND	5
MA467R	B/B	STR	ROUND	5 3/4
BC171R	S/S	CVD	ROUND	4 1/4
BC173R	B/B	CVD	ROUND	4 1/4
BC195R	B/B	CVD	ROUND	5
MA466R	B/B	CVD	ROUND	5 3/4



ENT NASAL

ENT-NASAL

Scissors

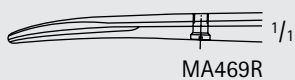
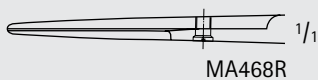
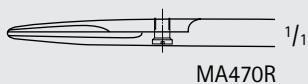

STEVENS Tenotomy Scissors

Catalog Number	Tip	Blade	Handle	Weight	Length (in.)
MA470R	B/B	STR	RIBBON	LIGHT	3 3/4
MA468R	B/B	STR	RIBBON	HEAVY	3 7/8
MA469R	B/B	CVD	RIBBON	HEAVY	3 3/4

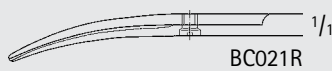
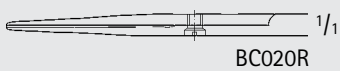
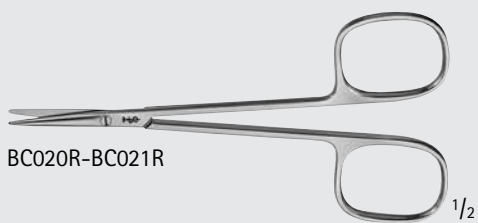

Strabismus Scissors, Delicate

Catalog Number	Tip	Blade	Handle	Length (in.)
BC020R	B/B	STR	SQUARE	4 1/2
BC021R	B/B	CVD	SQUARE	4 1/2

ENT
NASAL

MILLIMETERS

DUROTIP Tungsten Carbide Scissors

- Excellent cutting accuracy
- Long working life
- Gold-plated rings

DUROTIP TC FOMON Dorsal Scissors

Catalog Number	Tip	Blade Angle	Length (in.)
MB540R	B/B	30°	5 1/4

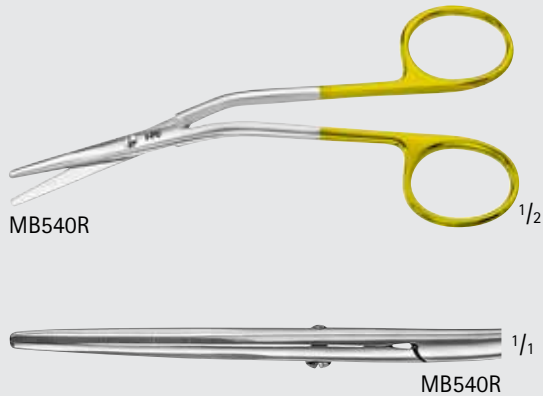

DUROTIP TC Iris Scissors, Delicate

Catalog Number	Tip	Blade	Length (in.)
BC210R	S/S	STR	4 1/4
BC211R	S/S	CVD	4 1/4

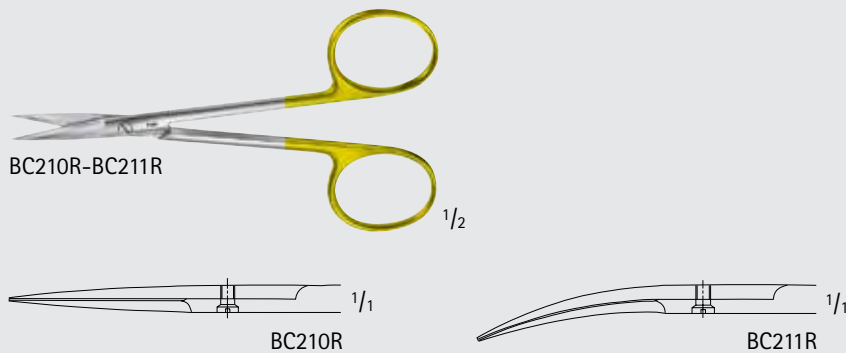

Wavecut

Wavecut scissors have one serrated cutting edge to prevent tissue from slipping.

The W after the catalog number indicates the scissors are the wavecut style, e.g. BC211W.

DUROTIP TC Iris Scissors, Wavecut

Catalog Number	Tip	Blade	Length (in.)
BC211W	S/S	CVD	4 1/4

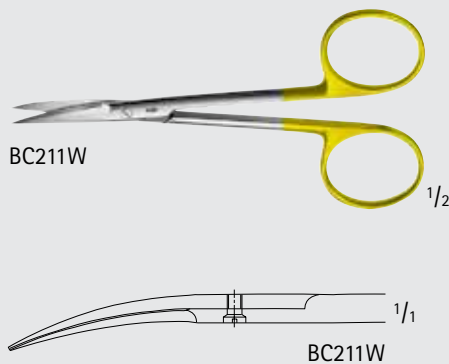

ENT-NASAL

DUROTIP™ TC Scissors

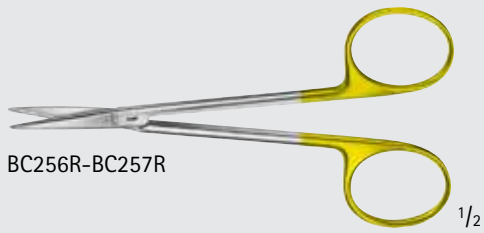

BC256R-BC257R

1/2

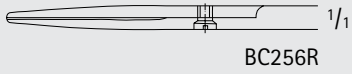

BC256R

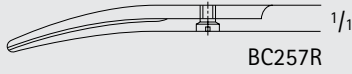

BC257R

DUROTIP TC Strabismus Scissors, Delicate

Catalog Number	Tip	Blade	Length (in.)
BC256R	B/B	STR	4 1/2
BC257R	B/B	CVD	4 1/2

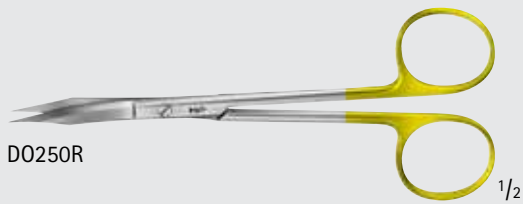

D0250R

1/2

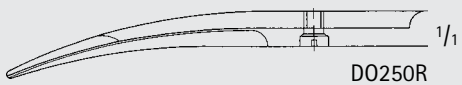

D0250R

DUROTIP TC GOLDMAN-FOX Tenotomy Scissors, Delicate

Catalog Number	Tip	Blade	Length (in.)
D0250R	S/S	CVD, 1/SERR	5 1/8

ENT
NASAL

MILLIMETERS

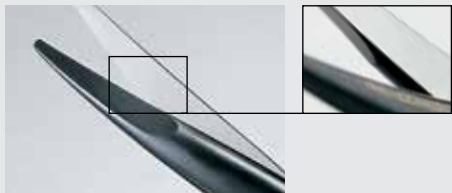

Microtome Edge



Wavecut

Noir Supreme Cut Scissors

- **Noir**
The combination of the renowned Aesculap Tungsten Carbide technology with the Aesculap Noir coating results in an extremely high surface hardness and therefore high wear resistance in daily hospital use.
- **Microtome edge**
The extremely sharp cutting edge of the scissors blade facilitates gentle cutting of tissue with minimal use of force.
- **Wavecut** helps prevent tissue from slipping out during the cutting process.
- The WB after the catalog number indicates the Noir scissors are the wavecut style, e.g. BC211WB.

For more information about Noir Supreme Cut Scissors see our brochure number DOC637.

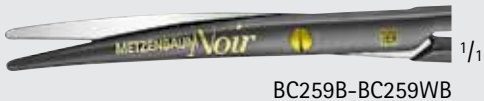

Noir Baby METZENBAUM Dissecting Scissors

Catalog Number	Tip	Blade	Length (in.)
BC259B	B/B	CVD	5 3/4
BC259WB	B/B	CVD	5 3/4



Noir Strabismus Dissecting Scissors

Catalog Number	Tip	Blade	Length (in.)
BC257B	B/B	CVD	4 1/2
BC257WB	B/B	CVD	4 1/2

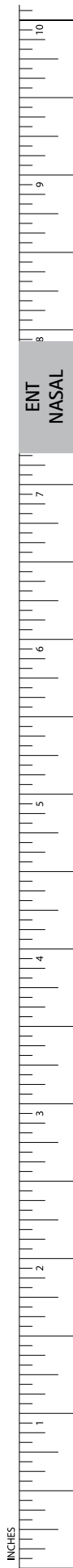

ENT-NASAL

SuperCut Scissors

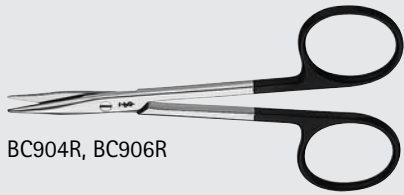

BC904R, BC906R

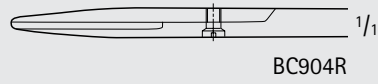

BC904R

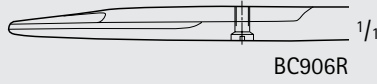

BC906R



BC905R, BC907R

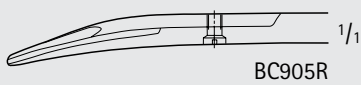

BC905R

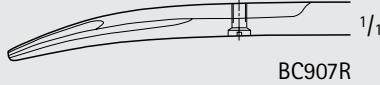

BC907R

STEVENS SuperCut Scissors

Catalog Number	Tip	Tip Size (mm)	Blade	Length (in.)
BC904R	B/B	12	STR	4 1/8
BC906R	B/B	13	STR	4 1/4
BC905R	B/B	12	CVD	4 1/8
BC907R	B/B	13	CVD	4 1/4



BC939R

1/2



BC939R

1/1

FOMON SuperCut Scissors

Catalog Number	Tip	Blade	Length (in.)
BC939R	B/B	CVD	4 1/2

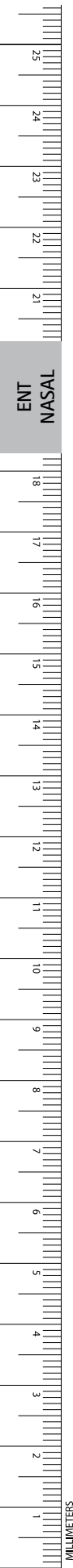

SF812R



Septum Needle W/ Luer Lock, Attachment

Catalog Number	Tip Size (mm)	Length (in.)
SF812R	DIAM. 0.8	3 1/2

MA553R, MA551R, MA552R

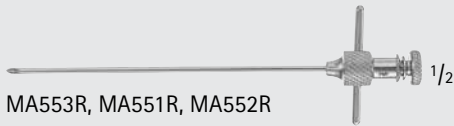

Antrum Trocar Needle

Catalog Number	Tip	Size	Length (in.)
MA553R	BEVELED STYLET	14 GA	4 1/4
MA551R	BEVELED STYLET	16 GA	4 1/4
MA552R	BEVELED STYLET	18 GA	4 1/4

MA553R, MA551R, MA552R



MA601R

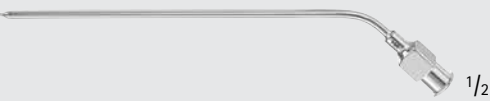

Septum Needle

Catalog Number	Tip	Size	Length (in.)
MA601R	ANG	22	5 3/8

MA554R



COAKLEY Antrum Trocar, with Irrigation Extension

Catalog Number	Length (in.)
MA554R	6 1/4

MA554R



ENT-NASAL

Trocars and Needles



Sinoscopy Trocar and Cannula

Catalog Number	Tip Size (mm)	Length (in.)
MA597R	4	6 1/2
MA598R	5	6 1/2

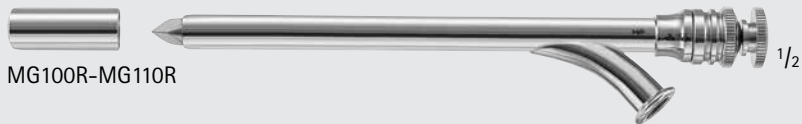

OCHSNER Trocar

Catalog Number	Tip Size (FR)	Length (in.)
MG100R	10	6
MG101R	12	6
MG102R	14	6
MG103R	16	6
MG104R	18	6
MG105R	20	6
MG106R	22	6
MG107R	24	6
MG108R	26	6
MG109R	27	6
MG110R	28	6

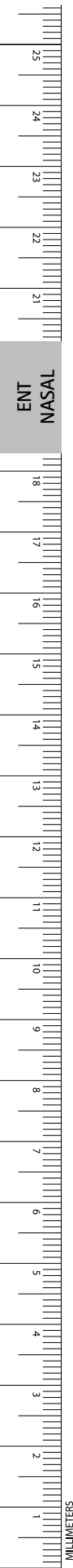

BROWN Needle Holder, Heavy

Catalog Number	Tip Size (mm)	Jaw	Length (in.)
MA362R	13	SERR	5 1/4

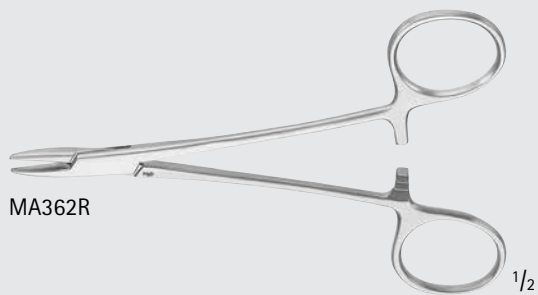

MA362R

1/2



MA362R

1/1

SOFFERMAN Needle Holder

Catalog Number	Tip Size (mm)	Jaw	Working Length (in.)
MA627R	5	STR, SERR	3 5/8

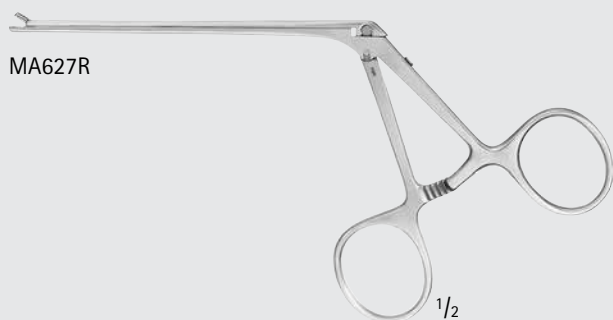

MA627R

1/2



MA627R

1/1

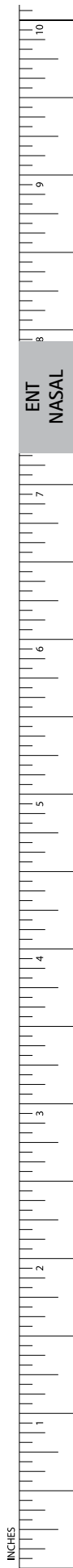

INCHES

ENT-NASAL

Forceps- Tissue/Dressing/Sponge



MA537R

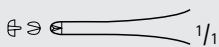

MA537R

CALLISON-ADSON Tissue Forceps, W/ Platform

Catalog Number	Teeth	Length (in.)
MA537R	1 x 2	5



MA070R



BD879R-BD878R

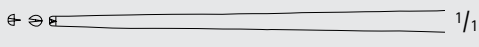

BD879R

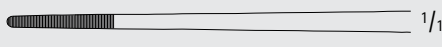

BD878R

LUCAE Bayonet Forceps

Catalog Number	Tip	Teeth	Length (in.)
BD879R	SMOOTH	1 x 2	5 1/2
BD878R	SERR	-	5 1/2
MA331R	SERR	-	6 3/8
MA070R	DEL, SERR	-	5 3/4



MA331R



MA331R



MA070R

JANSEN Bayonet Forceps

Catalog Number	Tip	Length (in.)
BD880R	SERR	6 1/4
MB236	SERR	6 1/2



BD880R, MB236

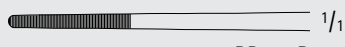

BD880R



MB236

ENT
NASAL

ENT-NASAL

Forceps- Tissue/Dressing/Sponge

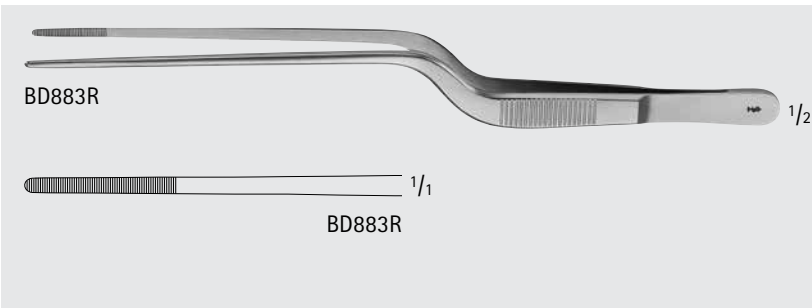

GRUENWALD Bayonet Forceps

Catalog Number	Tip	Length (in.)
BD883R	SERR	7 7/8

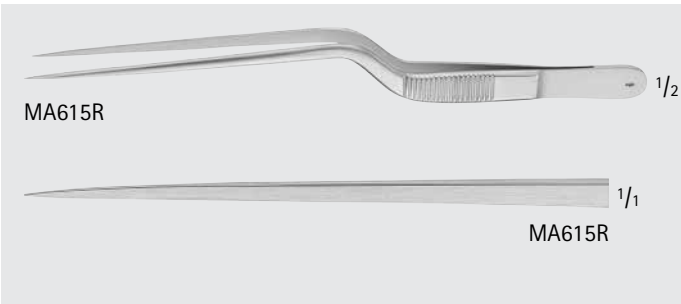

JACOBSON Forceps

Catalog Number	Tip	Length (in.)
MA615R	SMOOTH, SHARP	6 1/4

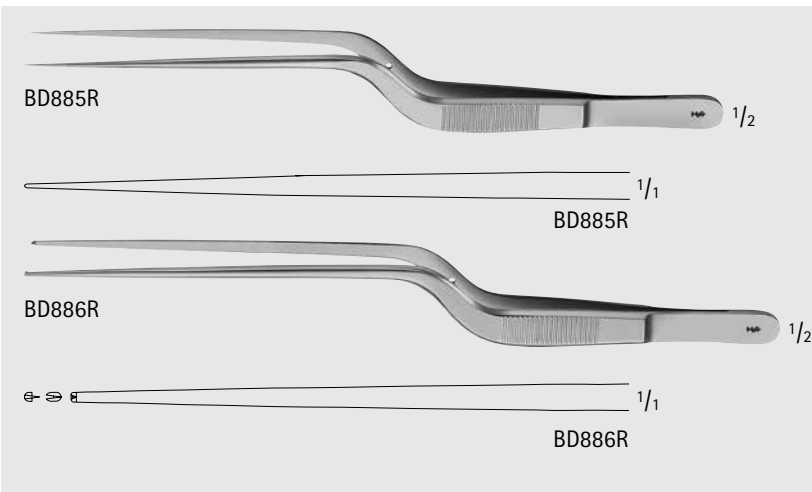

Bayonet Forceps

Catalog Number	Tip	Teeth	Length (in.)
BD885R	SMOOTH	-	7 1/4
BD886R	SMOOTH	1 x 2	7 7/8

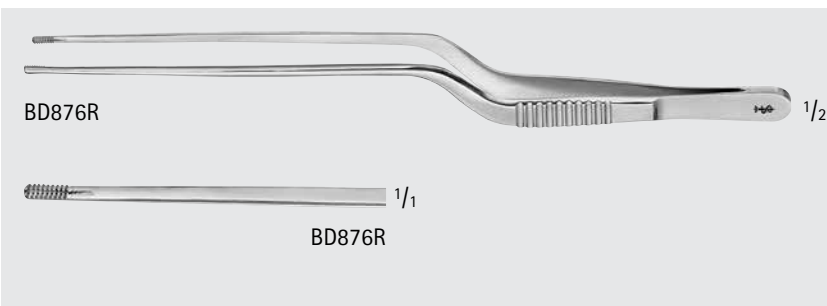

BROWN-BAHNSON Bayonet Forceps

Catalog Number	Tip	Length (in.)
BD876R	SERR	6 1/8

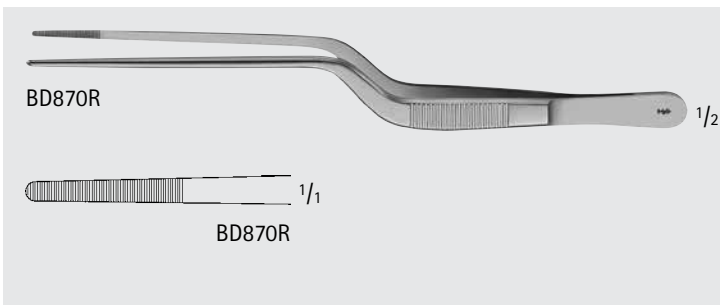

ADSON Bayonet Forceps

Catalog Number	Tip	Length (in.)
BD870R	SERR	6 7/8



ENT-NASAL

Forceps- Tissue/Dressing/Sponge



BD904R

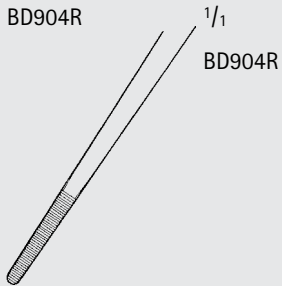

WILDE Forceps

Catalog Number	Tip	Length (in.)
BD904R	ANG/SERR	4 1/2



BD900R-BD902R

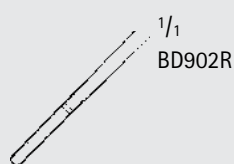
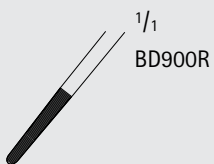

TROELTSCH Bayonet Forceps

Catalog Number	Tip	Length (in.)
BD900R	ANG/SERR	4
BD902R	ANG/SERR	4 1/2
BD910R	ANG/SERR	5 1/2
BD911R	ANG/SERR	6 3/4



BD910R-BD911R

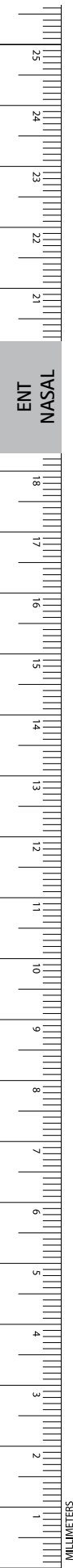
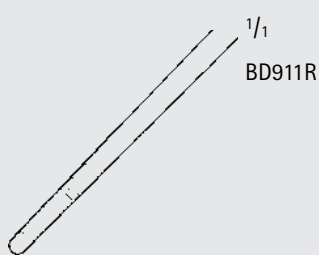
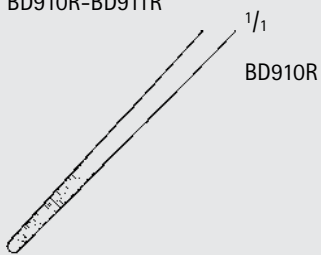

ENT-NASAL

Forceps- Tissue/Dressing/Sponge

HARTMANN Alligator Forceps

Catalog Number	Tip	Length (in.)
OK245R	ANG/SERR	7 1/2

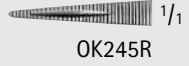
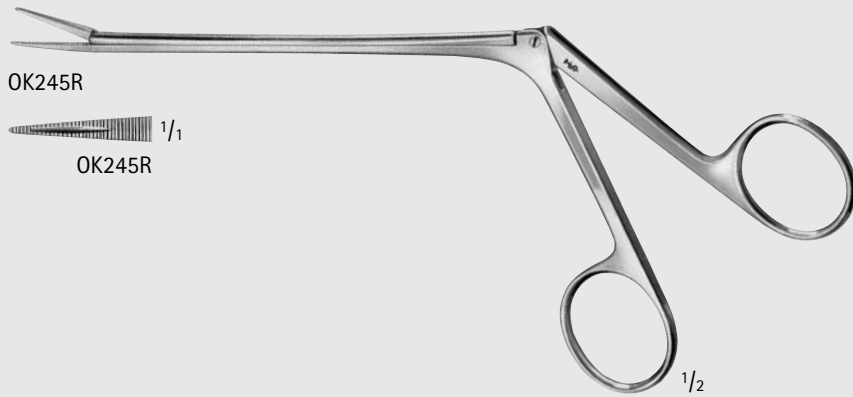

HARTMANN Nasal Dressing Forceps

Catalog Number	Length (in.)
OK242R	6 7/8
MA329R	7
OK243R	7 7/8
MA330R	8 1/2

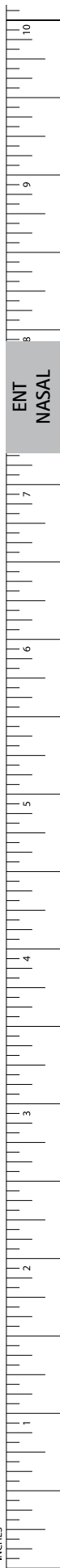
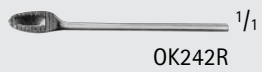

ENT-NASAL

Forceps- Tissue/Dressing/Sponge

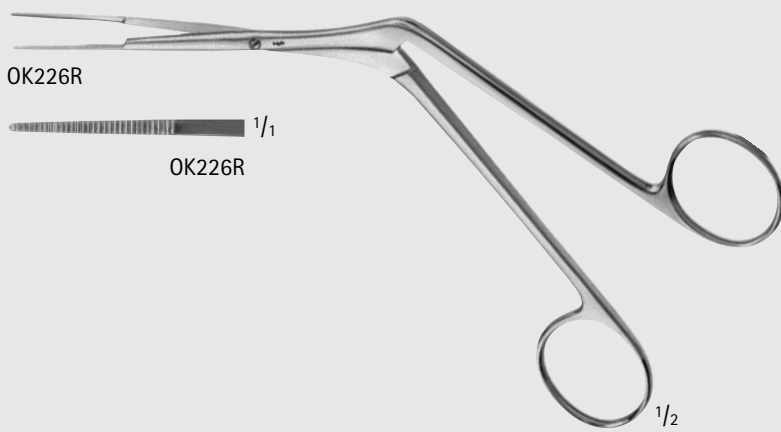

WEST Nasal Dressing Forceps

Catalog Number	Tip	Length (in.)
OK226R	SERR	7 7/8



OL010R

COTTLE Columella Clamp, W/ Fixation Screw

Catalog Number	Length (in.)
OL010R	4

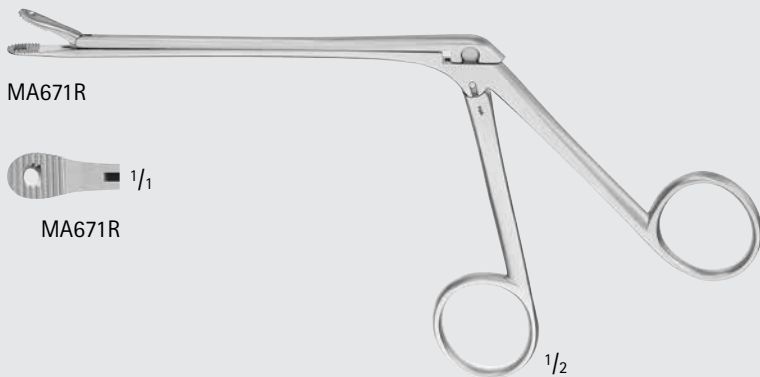

FERRIS-SMITH Fragment Forceps

Catalog Number	Tip Size (mm)	Working Length (in.)	Length (in.)
MA671R	8.2 x 6	4 1/4	7 7/8

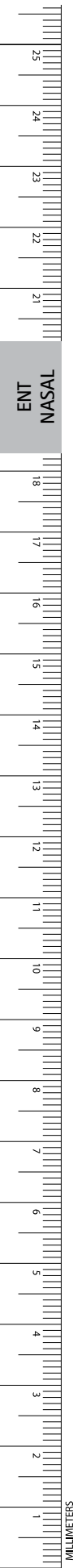

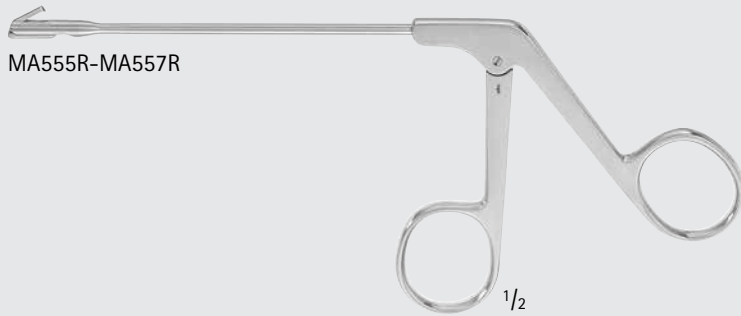

MA555R-MA557R

OSTRUM Antrum Backbiting Punch Forceps

Catalog Number	Jaw Size (mm)	Jaw	Working Length (in.)	Length (in.)
MA555R	3 x 7	STR	4 1/4	7 3/4
MA556R	3 x 7	ANG-LEFT	4 1/4	7 3/4
MA557R	3 x 7	ANG-RIGHT	4 1/4	7 3/4



MA555R



MA556R



MA557R



OK440R-OK443R

BRUENINGS Septum Forceps

Catalog Number	Size	Length (in.)
OK440R	SMALL	7 1/2
OK441R	MEDIUM	7 1/2
OK442R	LARGE	7 1/2
OK443R	X-LARGE	7 1/2



OK440R



OK442R

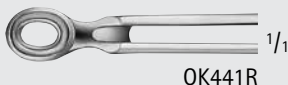

OK441R



OK443R

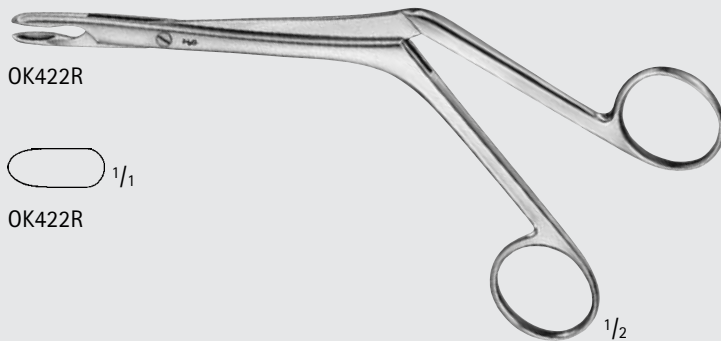

OK422R

HEYMANN-KNIGHT Septum Forceps

Catalog Number	Jaw	Length (in.)
OK422R	OVAL	7 1/2

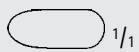

OK422R

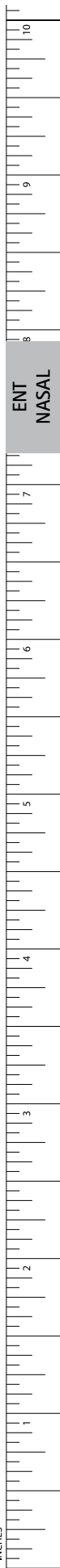

ENT-NASAL

Forceps- Nasal/Polyp/Bone Cutting

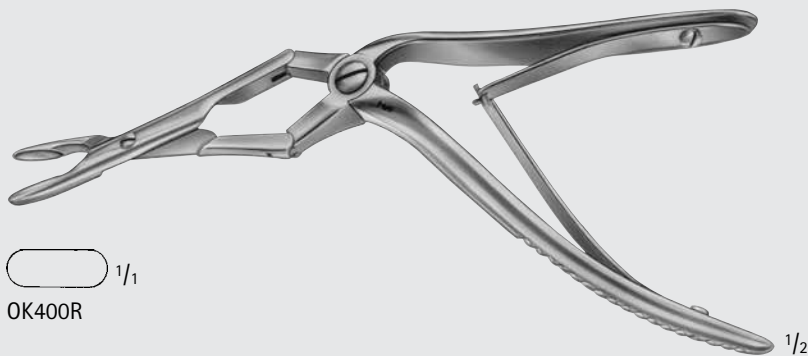

OK400R $\frac{1}{1}$

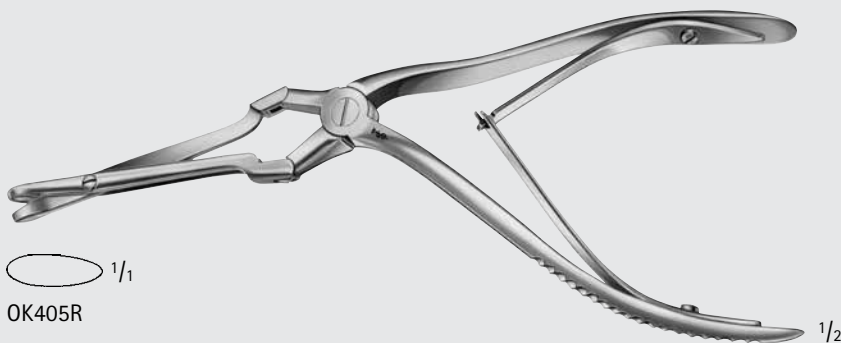

OK405R $\frac{1}{1}$

JANSEN-MIDDLETON Septum Forceps

Catalog Number	Jaw	Length (in.)
OK400R	SPOON	7 7/8
OK405R	THRU-CUT	8 1/4

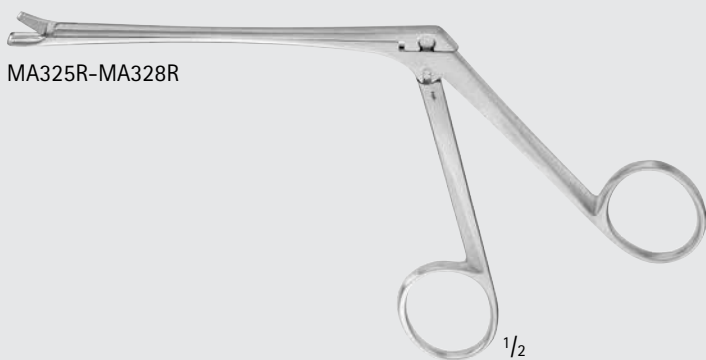

MA325R-MA328R



MA325R $\frac{1}{1}$



MA327R $\frac{1}{1}$



MA326R $\frac{1}{1}$



MA328R $\frac{1}{1}$

GRUENWALD Nasal Forceps

Catalog Number	Tip Size (mm)	Tip Size (#)	Working Length (in.)	Length (in.)
MA325R	2.5 x 9	1	4	7 1/4
MA326R	3 x 10	2	4	7 1/4
MA327R	3.5 x 11	3	4	7 1/4
MA328R	3.5 x 10	3	4	7 1/4

ENT
NASAL

MILLIMETERS

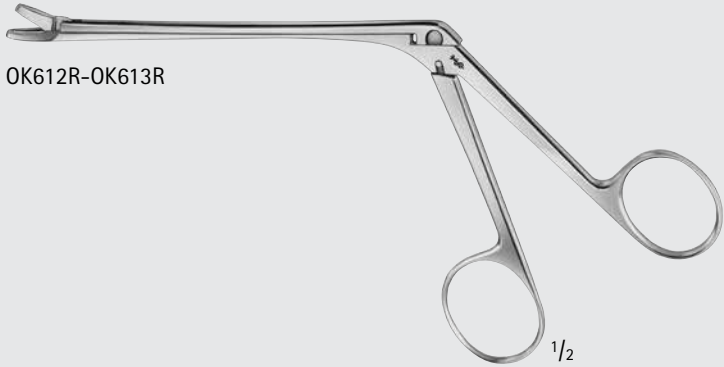

OK612R-OK613R

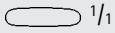

 1/1
OK612R

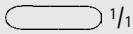
 1/1
OK613R

GRUENWALD-HENKE Nasal Thru-Cut Rongeur

Catalog Number	Jaw	Working Length (in.)
OK612R	SMALL	4 3/4
OK613R	LARGE	4 3/4

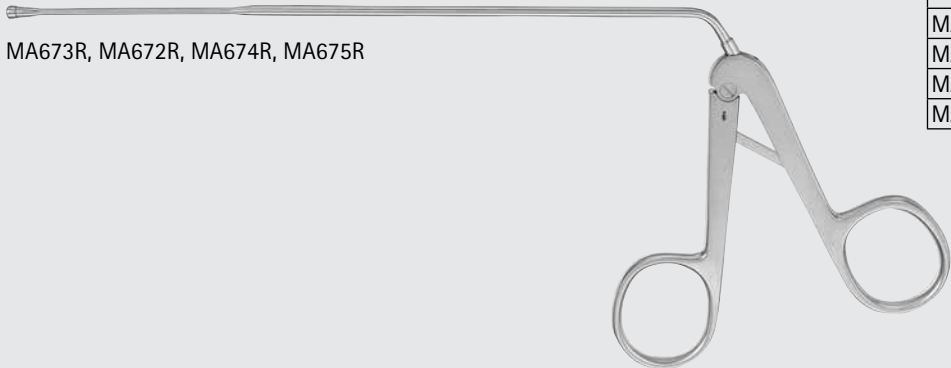

MA673R, MA672R, MA674R, MA675R

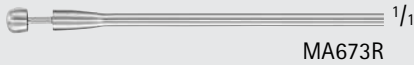

MA673R

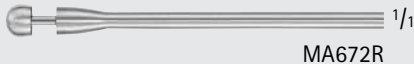

MA672R

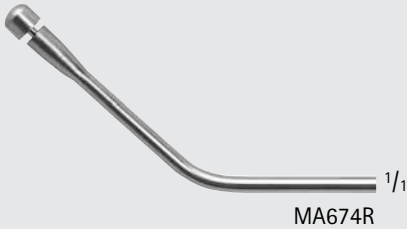

MA674R

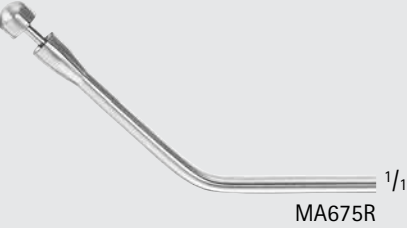

MA675R

STAMMBERGER Circular Punch Forceps

Catalog Number	Tip	Tip Size (mm)	Working Length (in.)	Length (in.)
MA673R	STR	3.5	7 1/2	9 3/4
MA672R	STR	4.5	7 1/2	9 3/4
MA674R	70° UP	3.5	7 1/4	9 5/8
MA675R	70° UP	4.5	7 1/4	10 1/4



INCHES

ENT-NASAL

Forceps- Nasal/Polyp/Bone Cutting

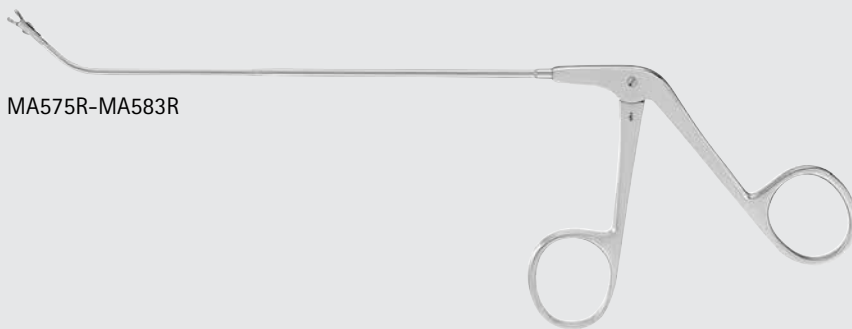
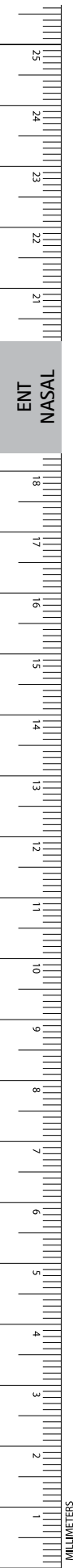

MA575R-MA583R



MA575R, MA577R $\frac{1}{1}$



MA576R, MA580R $\frac{1}{1}$

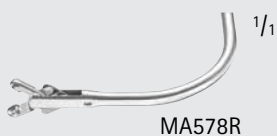

MA578R $\frac{1}{1}$



MA579R $\frac{1}{1}$

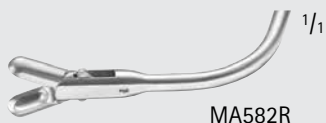

MA582R $\frac{1}{1}$



MA581R, MA583R $\frac{1}{1}$

Giraffe Frontal Sinus Forceps

Catalog Number	Jaw	Cup Size (mm)	Working Length (in.)	Length (in.)
MA575R	ANG 45° VERTICAL CUTTING	2	5 1/2	8 7/8
MA576R	ANG 45° HORIZONTAL CUTTING	2	5 1/2	8 7/8
MA577R	ANG 90° VERTICAL CUTTING	2	5 1/8	8 3/8
MA578R	ANG 90° HORIZONTAL CUTTING	2	5 1/8	8 3/8
MA579R	ANG 45° VERTICAL CUTTING	3	5 1/2	8 7/8
MA581R	ANG 70° VERTICAL CUTTING DOUBLE ACTION	3	5 1/8	8 1/4
MA580R	ANG 90° HORIZONTAL CUTTING	3	5 1/2	8 7/8
MA582R	ANG 70° HORIZONTAL CUTTING DOUBLE ACTION	4	5 1/8	8 1/4
MA583R	ANG 100° HORIZONTAL CUTTING DOUBLE ACTION	4	4 5/8	8 1/4

Giraffe Thru-Cut Sinus Forceps

Catalog Number	Jaw	Cup Size (mm)	Working Length (in.)
MA584R	ANG 70° VERTICAL CUTTING	3 x 6	4 3/4

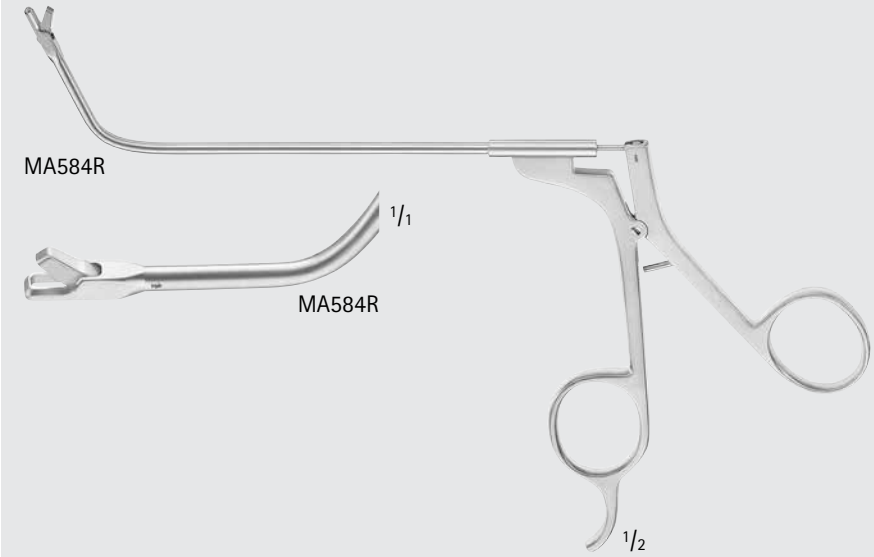

ENT-NASAL

Forceps- Nasal/Polyp/Bone Cutting

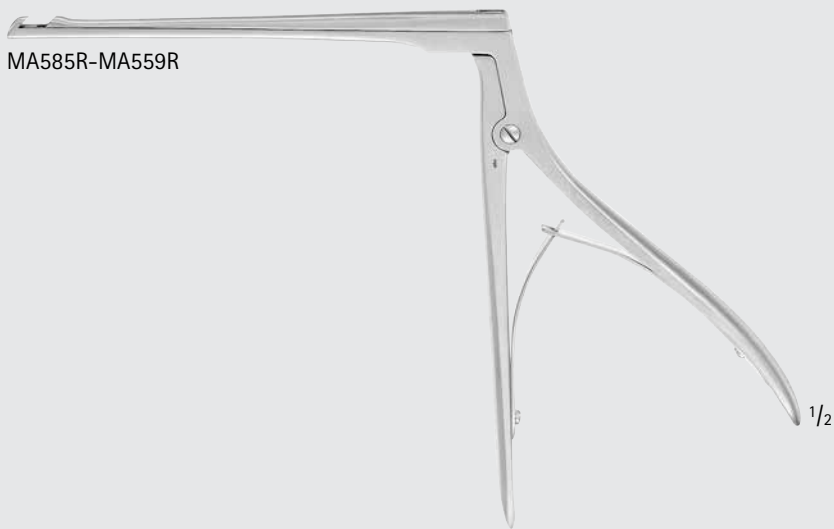

MA585R-MA559R



MA585R



MA559R

Antrum Punch Forceps

Catalog Number	Jaw	Tip	Cup Size (mm)	Working Length (in.)	Length (in.)
MA585R	ANG 45° BACKWARD 3 MM	3	4 x 5	5 1/2	8 1/4
MA559R	45° FORWARD 3 MM	3	4 x 5	5 1/2	8 1/4

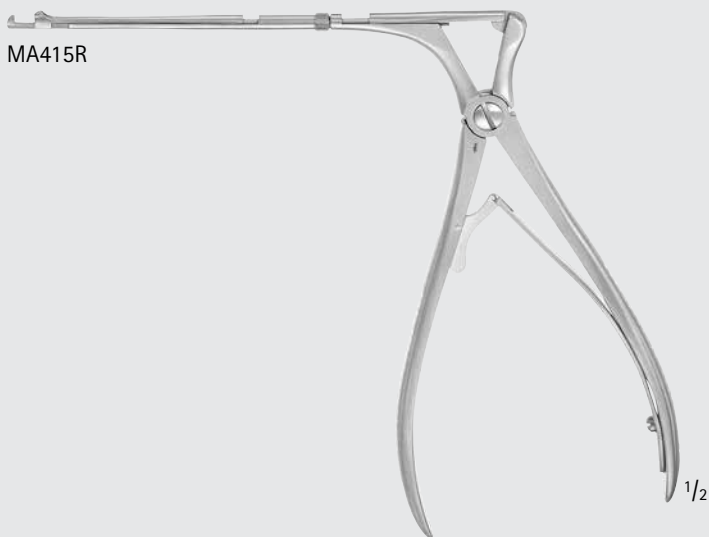

MA415R



MA415R

MCKENTY Sphenoid Punch Forceps, Rotatable

Catalog Number	Jaw	Working Length (in.)	Length (in.)
MA415R	1.5 x 4	5 3/4	7

ENT-NASAL

Forceps- Nasal/Polyp/Bone Cutting



KERRISON Nasal Rongeur

Catalog Number	Jaw Size (mm)	Jaw	Working Length (in.)
OK711R	4.0	90° UP	3 1/4
OK712R	5.0	90° UP	3 3/8

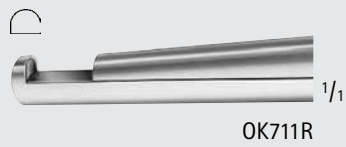

OK711R

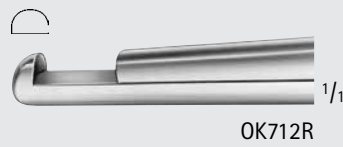

OK712R

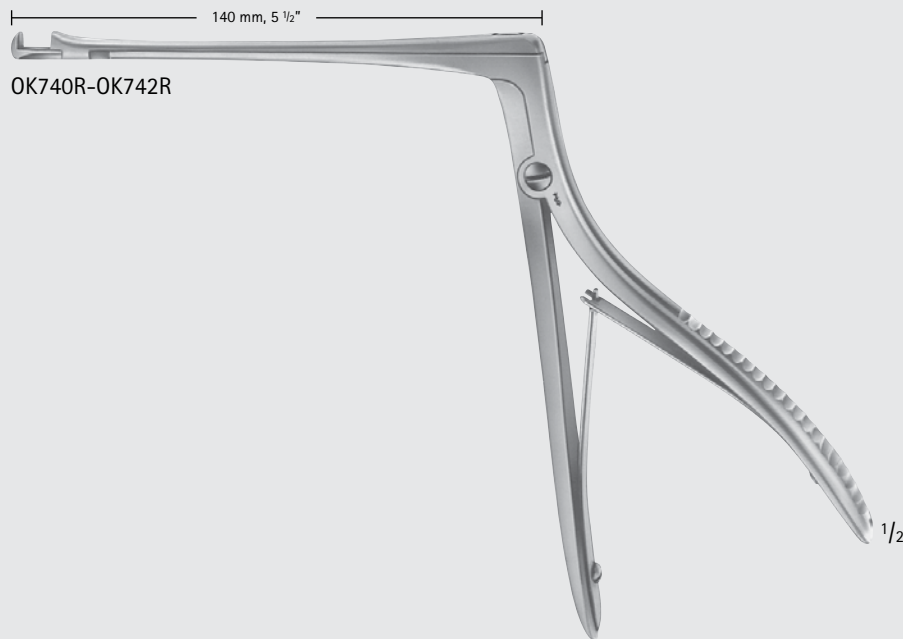

HAJEK-KOFLER Punch

Catalog Number	Jaw Size (mm)	Jaw	Working Length (in.)
OK740R	3.3	90° UP	5 1/2
OK741R	3.3	90° DOWN	5 1/2
OK742R	4.0	90° UP	5 1/2



OK740R

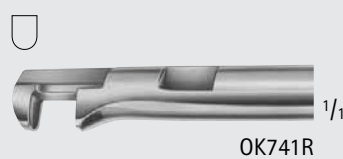

OK741R

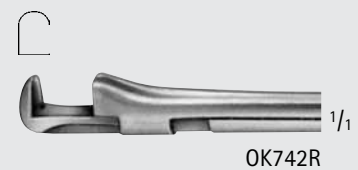

OK742R

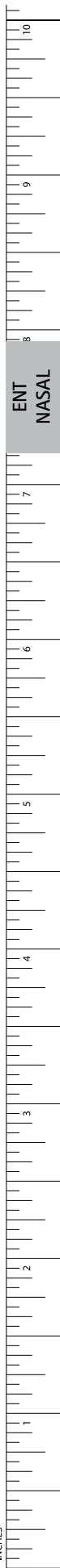

ENT-NASAL

Forceps- Nasal/Polyp/Bone Cutting



HAJEK-KOFLER Rotatable Punch, (continued)

Catalog Number	Jaw Size (mm)	Jaw	Working Length (in.)
OK745R	4.0	90° UP	6 3/4

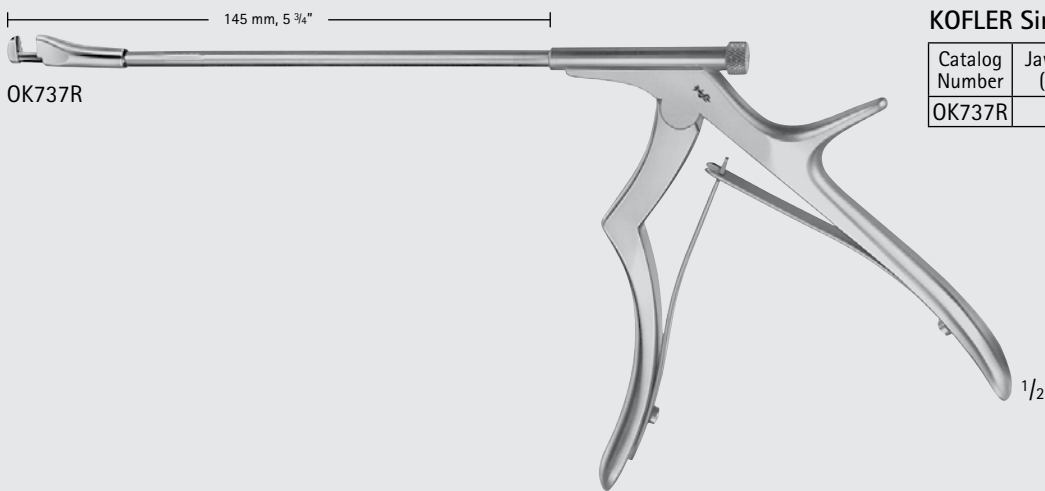
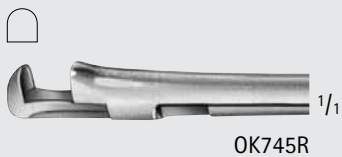

KOFLER Sinus Punch, Rotatable

Catalog Number	Jaw Size (mm)	Jaw	Working Length (in.)
OK737R	3.0	90° UP	5 3/4

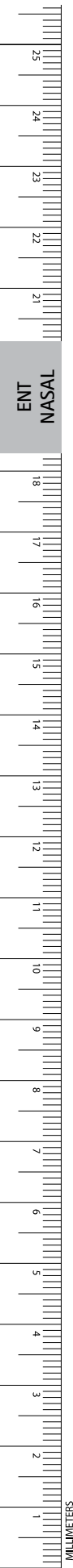



MA340R-MA343R, OK525R-OK526R

TAKAHASHI Nasal Forceps

Catalog Number	Jaw Size (mm)	Jaw	Working Length (in.)
MA342R	2.5	STR	4 3/8
OK525R	3.0	STR	4 3/4
MA340R	3.0	STR	6 3/8
MA343R	4.0	STR	4 3/8
MA341R	4.0	STR	6 3/8
OK526R	3.0	45° UP	4 3/4

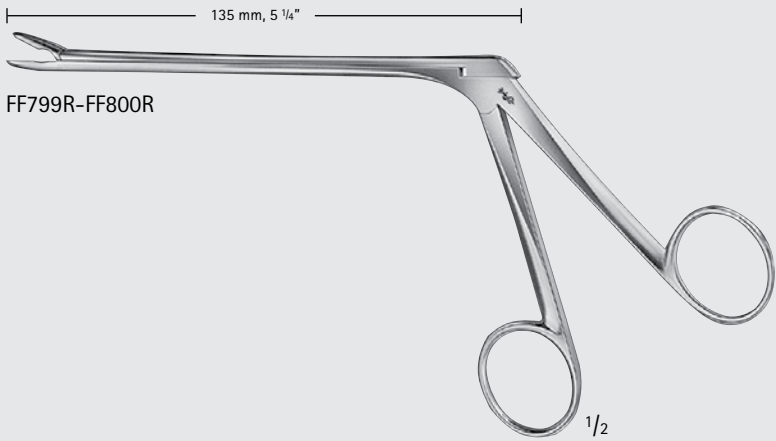
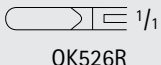
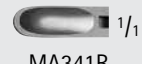
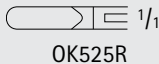
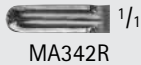

FF799R-FF800R

LOVE-GRUENWALD Rongeur

Catalog Number	Jaw Size (mm)	Jaw	Working Length (in.)
FF799R	2 x 10	STR	5 1/4
FF800R	3 x 10	STR	5 1/4

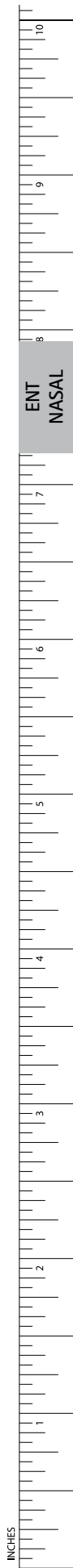
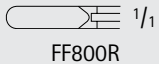
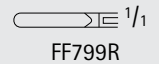

ENT-NASAL

Forceps- Nasal/Polyp/Bone Cutting

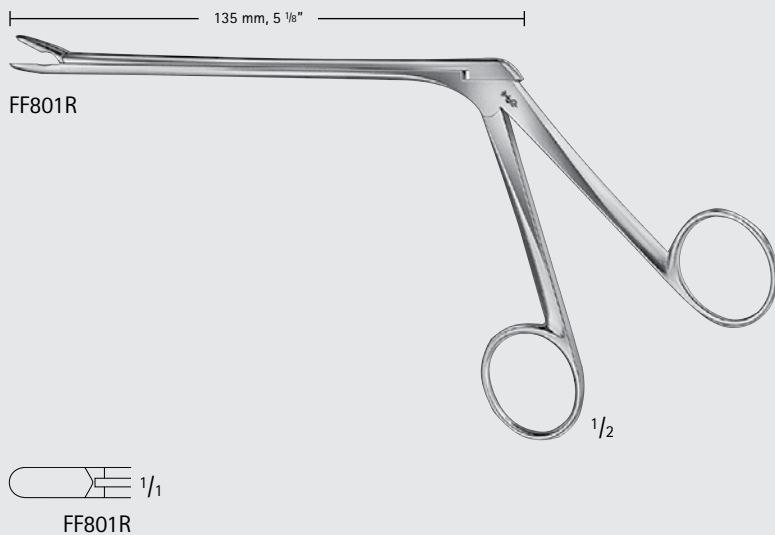

SPURLING Rongeur

Catalog Number	Jaw Size (mm)	Jaw	Working Length (in.)
FF801R	4 x 10	STR	5 1/8

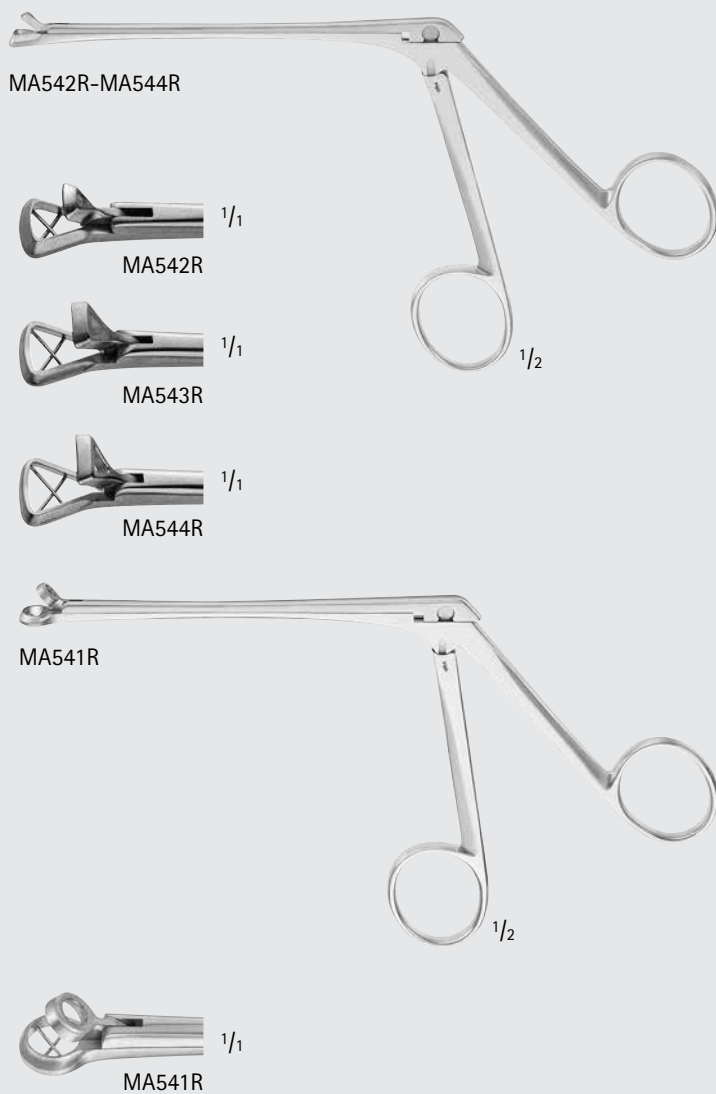

MELTZER Adenoid Punch Forceps

Catalog Number	Tip Size (mm)	Size (#)	Jaw	Working Length (in.)	Length (in.)
MA542R	5 MM BOTTOM BASKET, 4 MM UPPER JAW	0	TRIANGULAR	4 1/2	7 1/4
MA543R	7 MM BOTTOM BASKET, 3 MM UPPER JAW	1	TRIANGULAR	4 1/2	7 1/4
MA544R	9 MM BOTTOM BASKET, 8 MM UPPER JAW	2	TRIANGULAR	4 1/2	7 1/4
MA541R	6 MM BOTTOM BASKET, 5 MM UPPER BITE	1	ROUND	4 1/2	7 1/4

ENT
NASAL

MILLIMETERS

Nasal Biopsy Forceps

Catalog Number	Cup Size (mm)	Tip	Working Length (in.)	Length (in.)
MA676R	2.5 x 4	STR	5	7
MA680R	2.5 x 5	70° UP	4	7
MA678R	2.5 x 6	70° UP	3 1/2	7 1/4

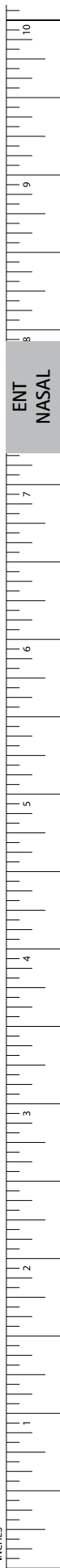
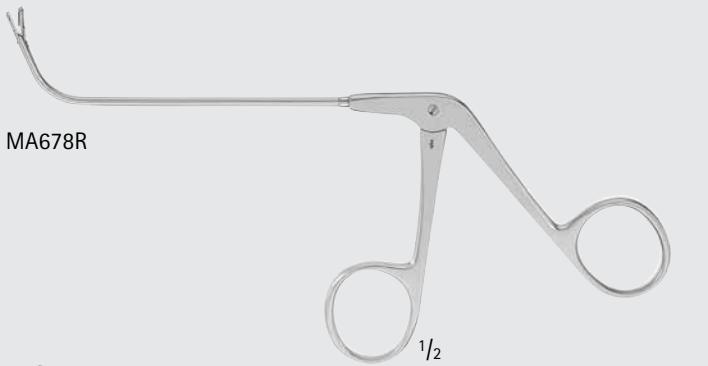
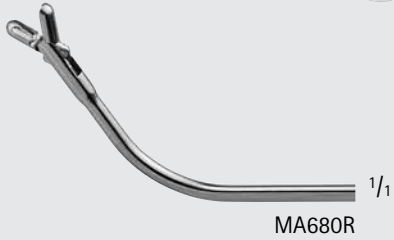
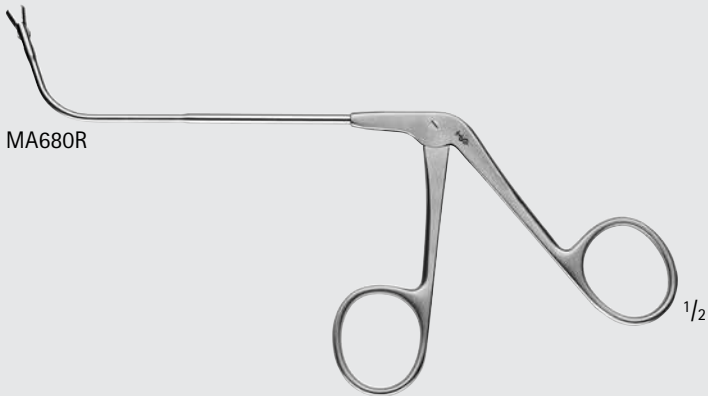
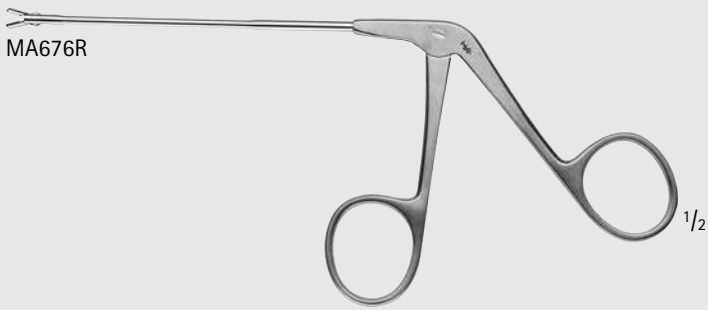

ENT-NASAL

Forceps- Nasal/Polyp/Bone Cutting

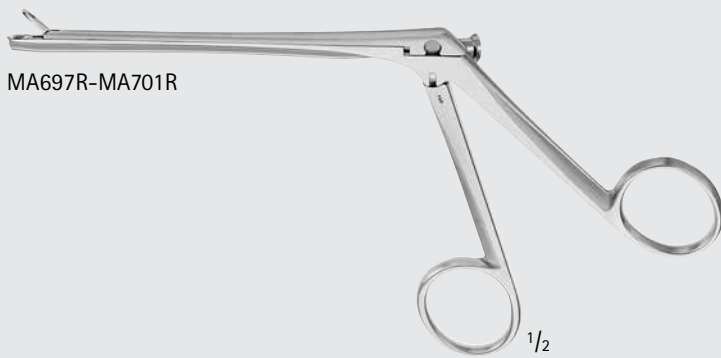

Nasal Suction Forceps

Catalog Number	Jaw Length (mm)	Tip	Tip Size (#)	Working Length (in.)	Length (in.)
MA697R	2.5	STR	00	4	7 1/4
MA699R	3.5	STR	0	4	7 1/4
MA701R	4.5	STR	1	4	7 1/4
MA698R	2.5	45° ANG-UP	00	4 3/4	7 1/4
MA700R	3.5	45° ANG-UP	0	4 1/2	7 3/4

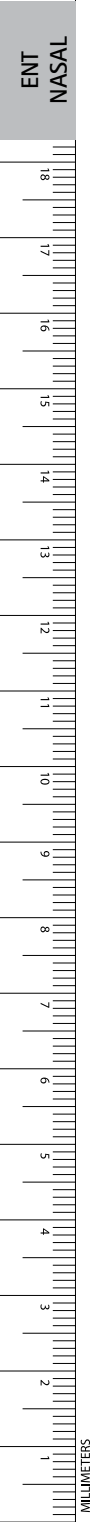
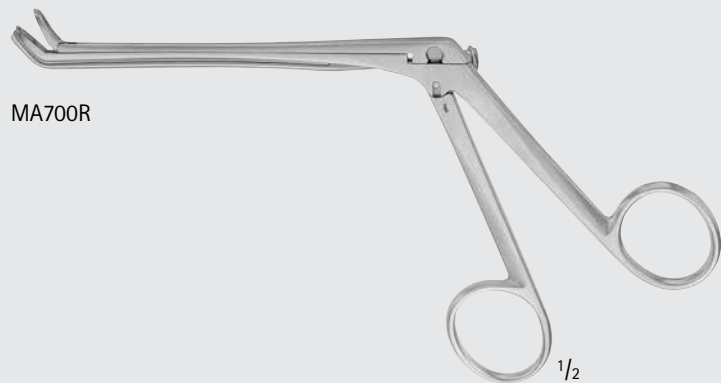

Pediatric Ostrum Antrum Punch
Forceps

Catalog Number	Jaw Size (mm)	Jaw	Working Length (in.)	Length (in.)
MA570R	1.5 x 4	STR BACK BITE	4 1/2	8
MA571R	1.5 x 4	RIGHT SIDE BITE	4 1/2	8
MA572R	1.5 x 4	LEFT SIDE BITE	4 1/2	8

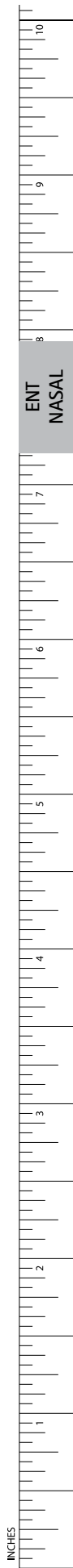

ENT-NASAL

Forceps- Nasal/Polyp/Bone Cutting



Ethmoid Forceps, Pediatric

Catalog Number	Jaw Size (mm)	Jaw	Working Length (in.)	Length (in.)
MA563R	3 x 5	STR	4	6 1/8
MA564R	3 x 5	ANG UP 45°	4	6 1/8
MA565R	3 x 5	ANG UP 90°	3 3/4	6 1/8



Rotating Ostrum Antrum Punch Forceps, Backbiting

Catalog Number	Jaw Size (mm)	Size	Jaw	Working Length (in.)	Length (in.)
MA574R	1.5 x 4	Pediatric	ROTATING 360°	4 1/4	8 1/4
MA573R	3 x 7	Adult	ROTATING 360°	4 1/4	8 1/4

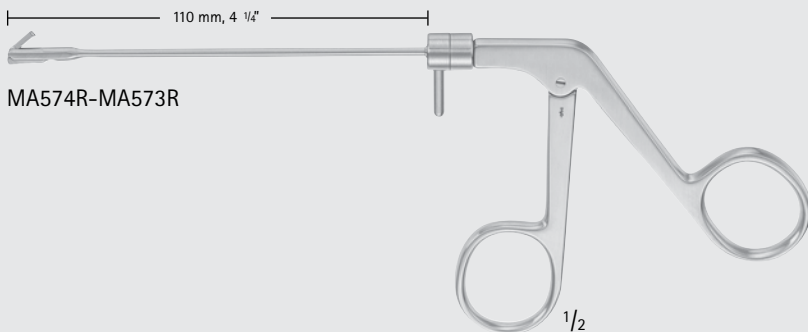

ENT
NASAL

MILLIMETERS

RONIS Adenoid Nasal Forceps

Catalog Number	Tip Size (mm)	Tip Size (#)	Jaw	Working Length (in.)	Length (in.)
MA545R	7 MM BASKET	1	TRIANGULAR	5 3/8	8 1/8
MA546R	8 MM BASKET	2	TRIANGULAR	5 3/8	8 1/8

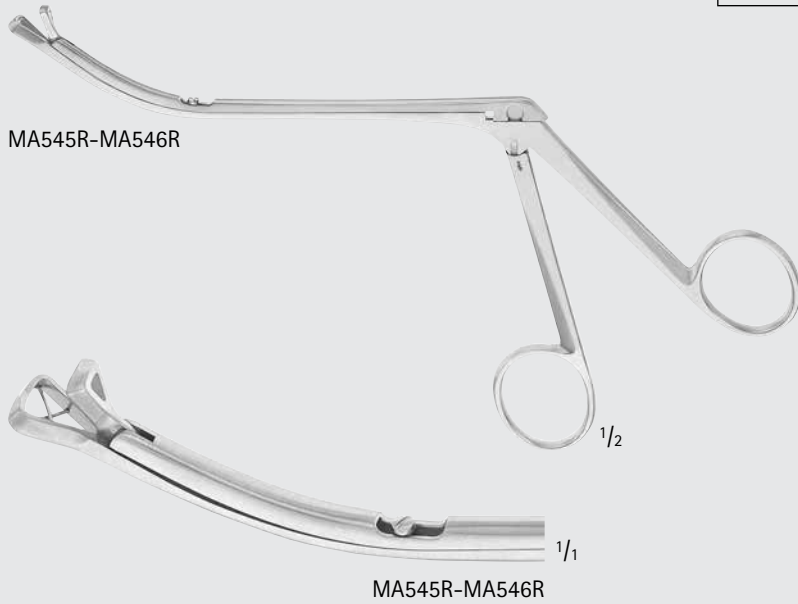

STAMMBERGER Sidecutting Antrum Punch Forceps

Catalog Number	Jaw	Length (in.)
MA568R	LEFT CUT	8 5/8
MA569R	RIGHT CUT	8 5/8

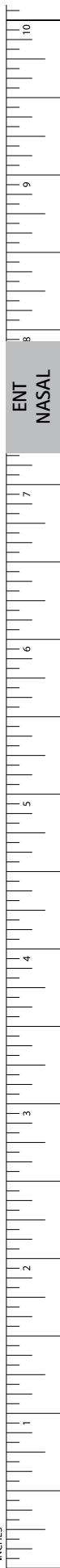
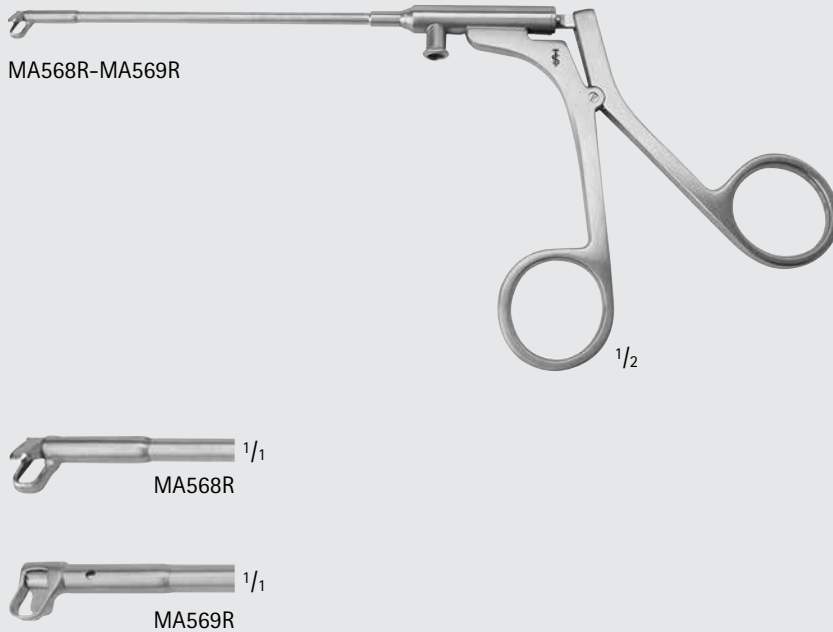

ENT-NASAL

Forceps- Nasal/Polyp/Bone Cutting

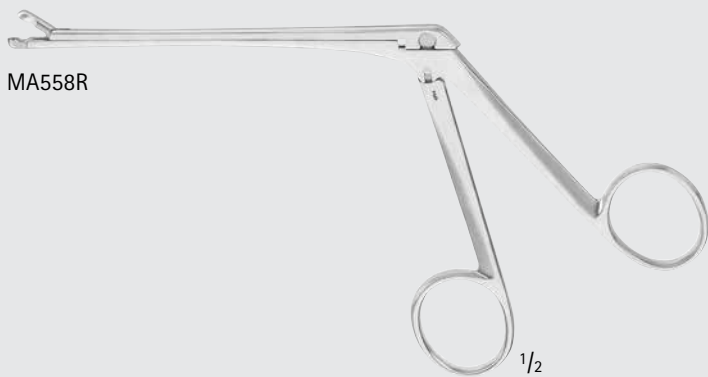

MA558R

Sinus Cup Forceps

Catalog Number	Cup Size (mm)	Working Length (in.)	Length (in.)
MA558R	3	4 1/2	7



MA558R



MA669R

COTTLE Biting Forceps

Catalog Number	Jaw Length (mm)	Jaw	Length (in.)
MA669R	30	ANG	7



MA669R

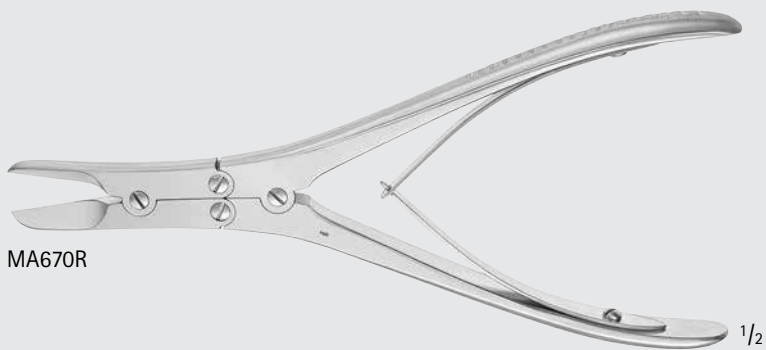

MA670R

ROWLAND Bone Cutting Forceps, Double Action

Catalog Number	Jaw Length (mm)	Length (in.)
MA670R	25	7 1/4

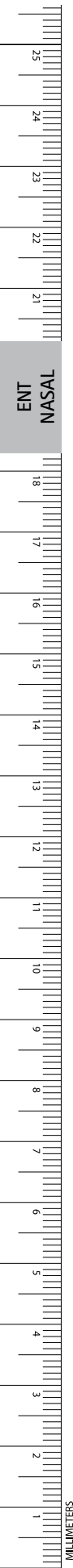

ENT-NASAL

Forceps- Nasal/Polyp/Bone Cutting

STAMM Bone Cutting Ronguer

Catalog Number	Length (in.)
F0604R	6



F0604R



F0604R



ENT-NASAL

Forceps- Nasal/Polyp/Bone Cutting

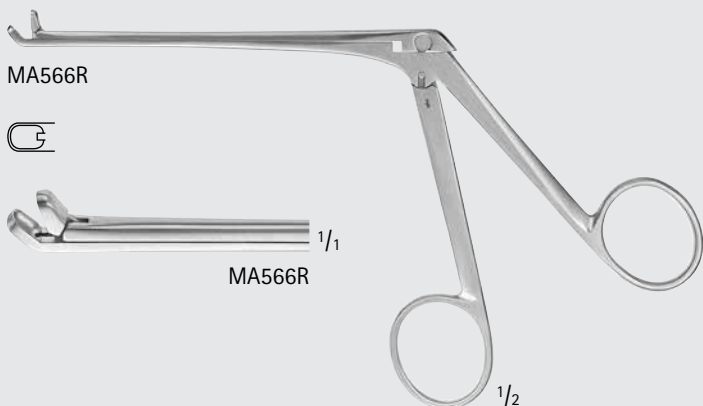

STUEMPEL-VOSS Nasal Forceps

Catalog Number	Cup (mm)	Tip	Working Length (in.)	Length (in.)
MA566R	3 x 5	ANG UP	4 1/4	6 7/8

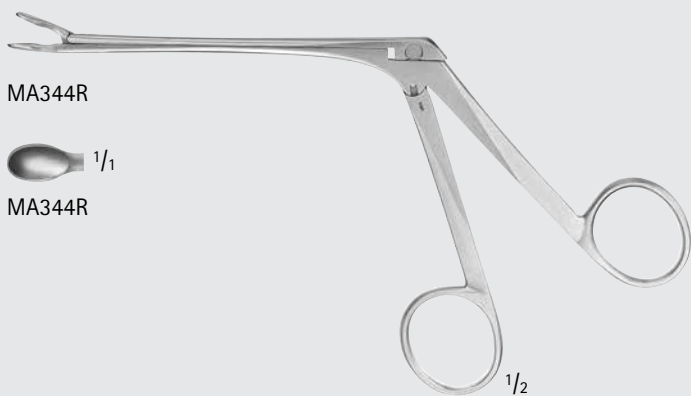

WEIL Nasal Forceps

Catalog Number	Cup (mm)	Tip	Working Length (in.)	Length (in.)
MA344R	5 x 8	STR	4	7 1/8
MA345R	5 x 8	ANG UP	4	7 1/8

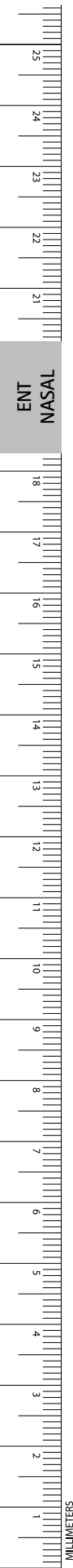
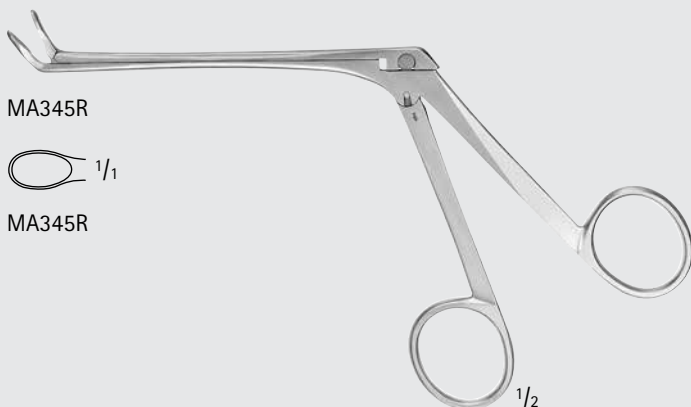

120 mm, 4 3/4"

OK505R-OK509R



110 mm, 4 1/4"

OK520R-OK522R

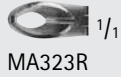
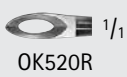
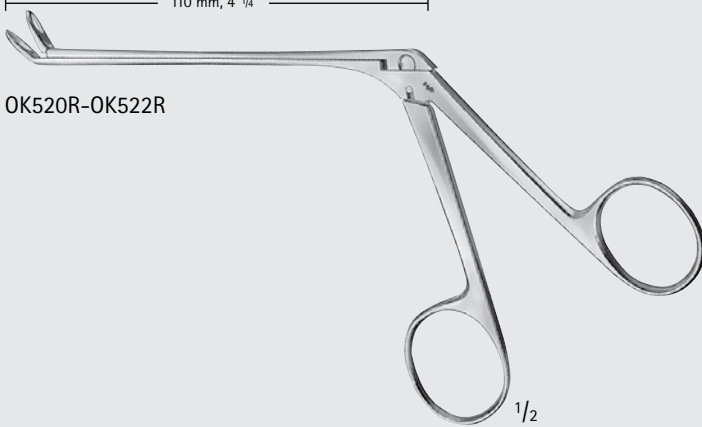

MA324R

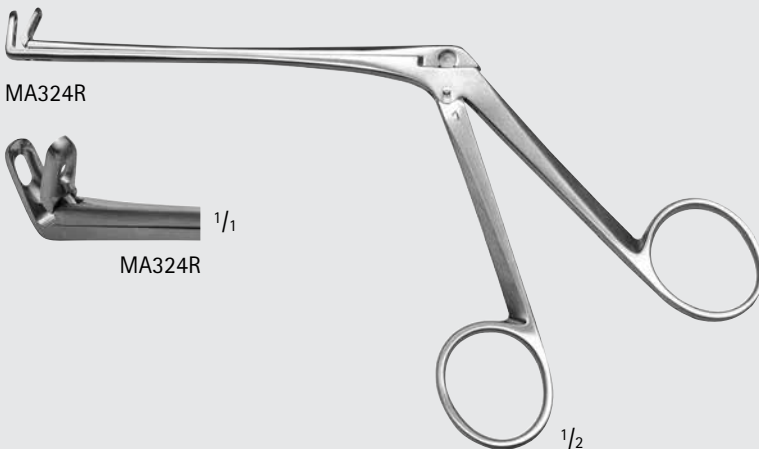

WEIL-BLAKESLEY Nasal Forceps

Catalog Number	Jaw Size (mm)	Tip	Tip Size (#)	Working Length (in.)
OK505R	3.0	STR	0	4 3/4
MA320R	3.5	STR	0	4
OK506R	3.6	STR	0	4 3/4
MA321R	4	STR	1	4 1/2
OK507R	4.2	STR	1	4 3/4
OK508R	4.8	STR	2	4 3/4
MA322R	5	STR	2	4 1/2
OK509R	5.6	STR	3	4 3/4
OK520R	3.6	ANG 45° UP	0	4 1/2
MA323R	4	ANG 45° UP	1	4 1/8
OK521R	4.2	ANG 45° UP	1	4 1/2
OK522R	4.8	ANG 45° UP	2	4 1/2
MA324R	4	ANG 90° UP	1	4

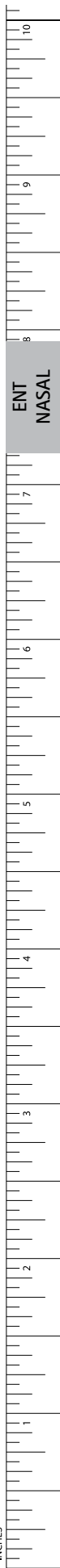

ENT-NASAL

Forceps- Nasal/Polyp/Bone Cutting



BLAKESLEY Thru-Cut Forceps

Catalog Number	Size	Jaw Size (mm)	Tip	Jaw Size (#)	Working Length (in.)	Length (in.)
MA694R	PEDIATRIC	2.5	STR	00	4 1/4	7
MA695R	PEDIATRIC	2.5	ANG	00	4 1/4	7
MA684R	-	3.5	STR	0	4 1/2	7 3/4
MA686R	-	2.5	ANG UP	00	4 3/8	7 1/4

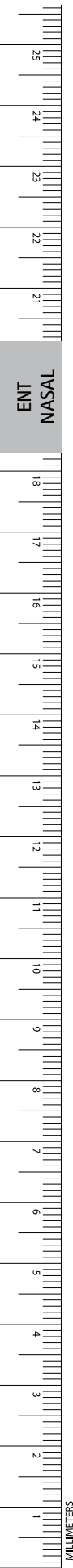
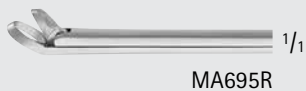
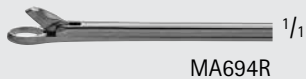

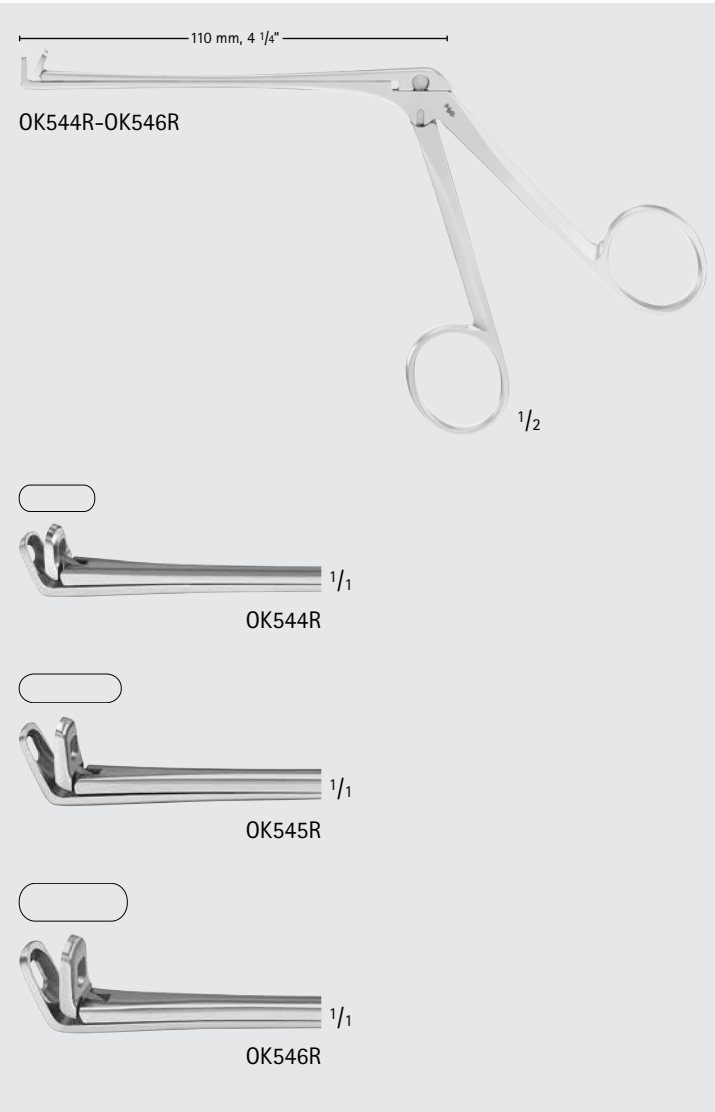

BLAKESLEY-WILDE Nasal Forceps

Catalog Number	Jaw Size (mm)	Tip	Working Length (in.)
OK544R	10 x 3.5	ANG 90° UP	4 1/4
OK545R	13.5 x 3.8	ANG 90° UP	4 1/4
OK546R	14.3 x 5	ANG 90° UP	4 1/4

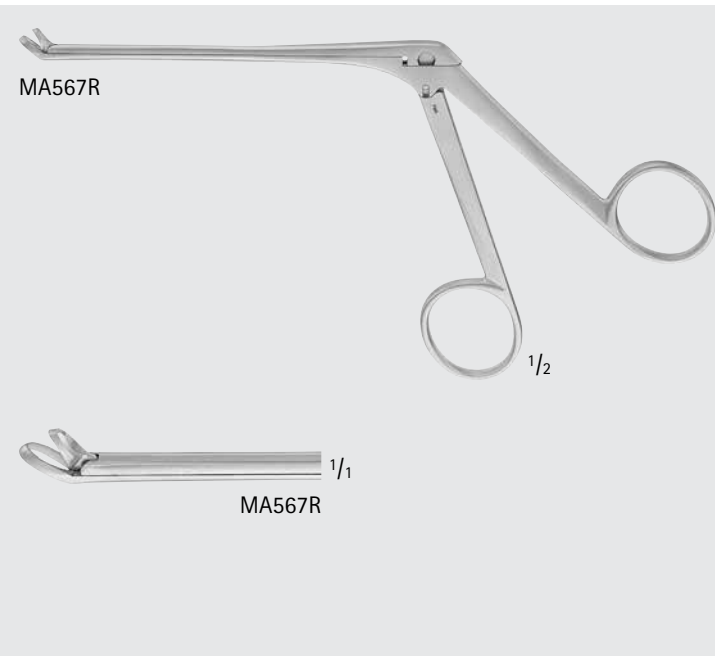

WILDE Ethmoid Nasal Forceps

Catalog Number	Jaw Size (mm)	Tip	Jaw Size (#)	Working Length (in.)
MA567R	3.5 x 12	ANG UP 45°	0	4 3/8

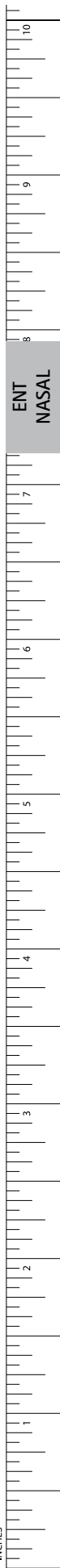

ENT-NASAL

Forceps- Nasal/Polyp/Bone Cutting

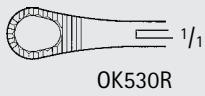

WATSON-WILLIAMS Ethmoid Forceps

Catalog Number	Jaw	Tip	Working Length (in.)
MA560R	3 MM THRU CUT JAWS W/ BASKET, ANG UP	ANG UP	5 3/8
OK530R	STR, SERR	STR	4 3/4

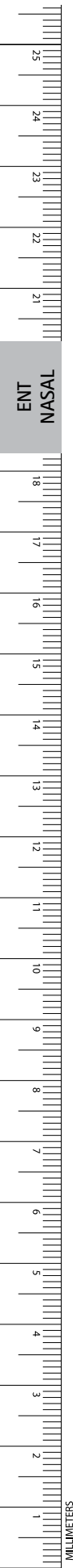

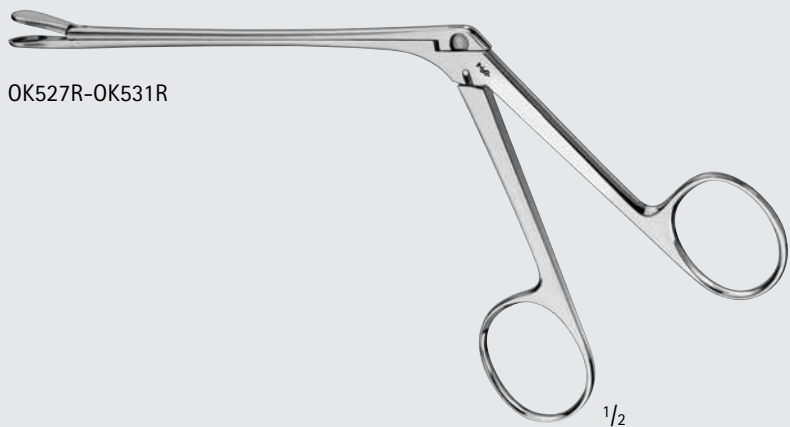

OK527R-OK531R

WATSON-WILLIAMS Ethmoid Forceps

Catalog Number	Jaw Size (mm)	Tip	Size	Working Length (in.)
OK527R	5.0	STR	SMALL	4 3/4
OK529R	7.0	STR	MEDIUM	4 3/4
OK531R	9.0	STR	LARGE	4 3/4

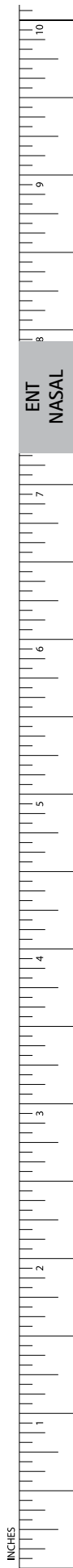
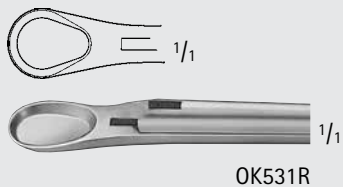
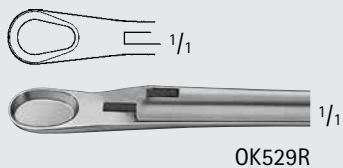
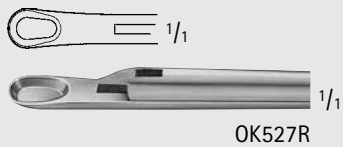

ENT-NASAL

Forceps- Nasal/Polyp/Bone Cutting



WILDE Nasal Forceps

Catalog Number	Jaw Size (mm)	Tip	Working Length (in.)	Length (in.)
MA561R	5 x 10	STR	4 1/2	7 1/4
MA562R	5 x 10	ANG UP	4 1/2	7 1/4

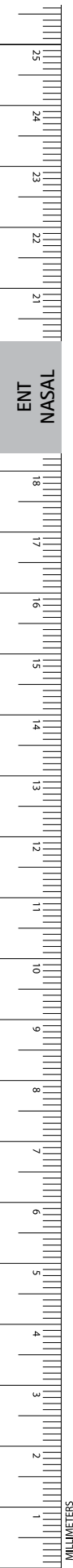
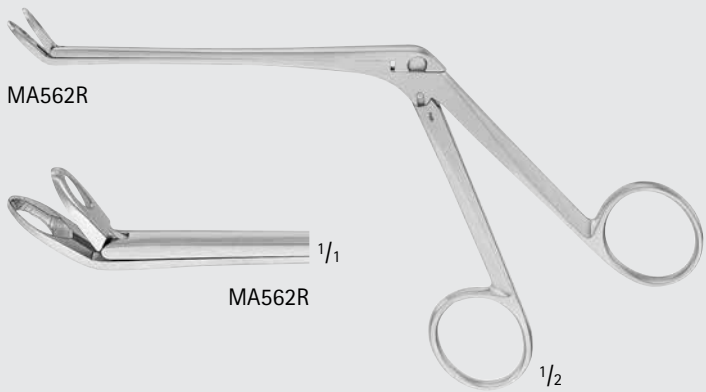

WILDE-Type Backbiter Forceps

Catalog Number	Jaw Size (mm)	Tip	Working Length (in.)	Length (in.)
MA688R	2	STR, ROTATING 360°	4 1/4	8 3/4
MA689R	2	CVD UP	3 1/8	6 7/8
MA690R	2	CVD DOWN	3 1/8	6 7/8

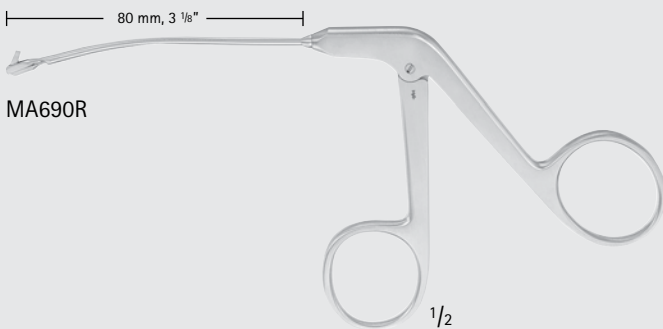
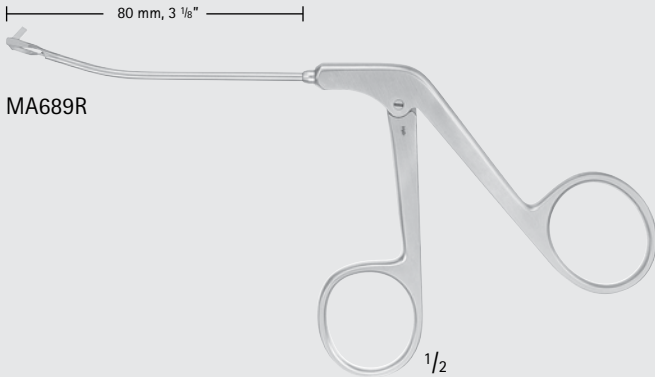
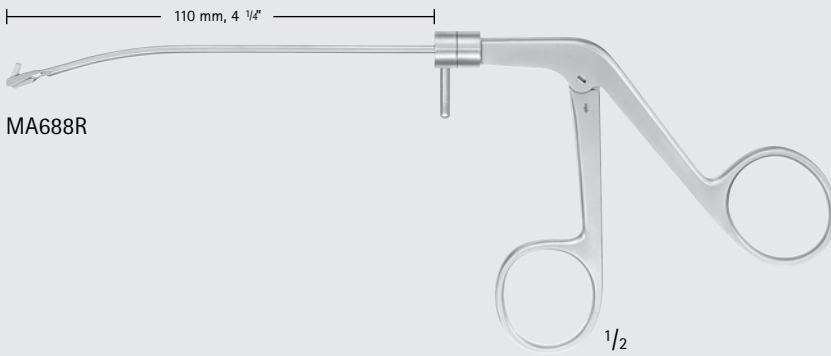

ENT-NASAL

Forceps- Cartilage/Morselizing/Straightening

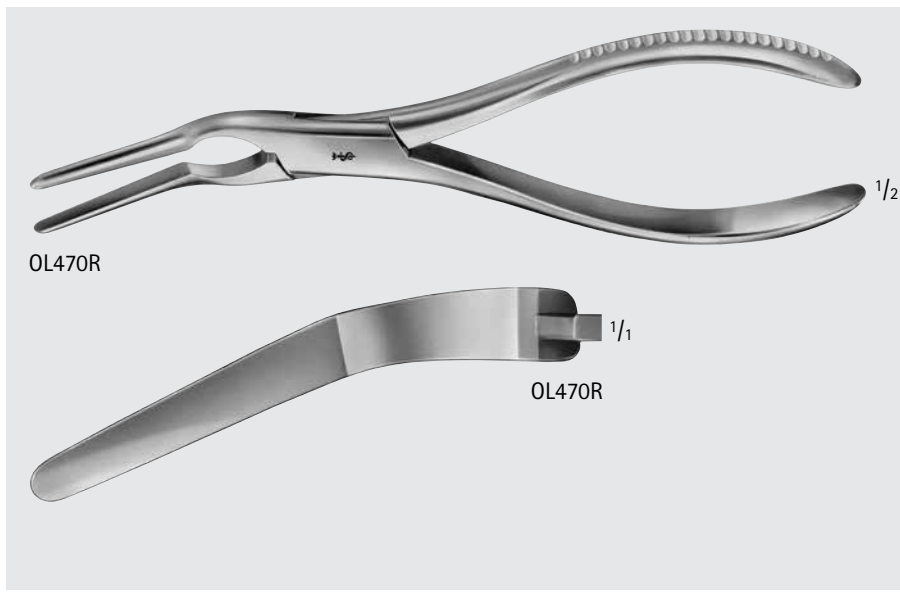
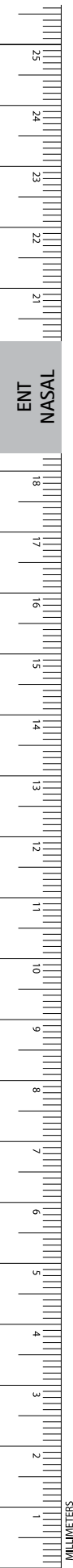

ASH Septum Forceps

Catalog Number	Tip	Length (in.)
OL470R	ANG	8 3/4

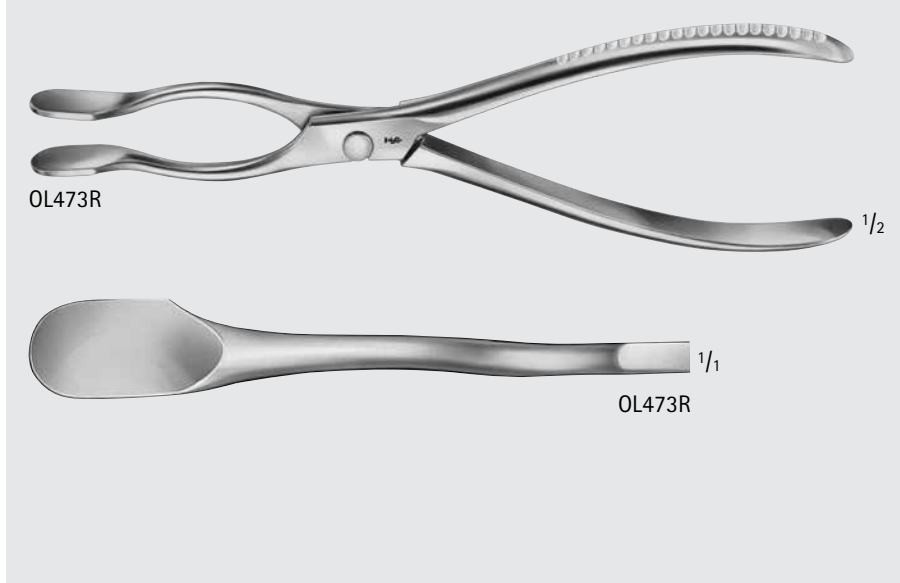

COTTLE-WALSHAM Septum Forceps

Catalog Number	Tip	Length (in.)
OL473R	STR	8 3/4

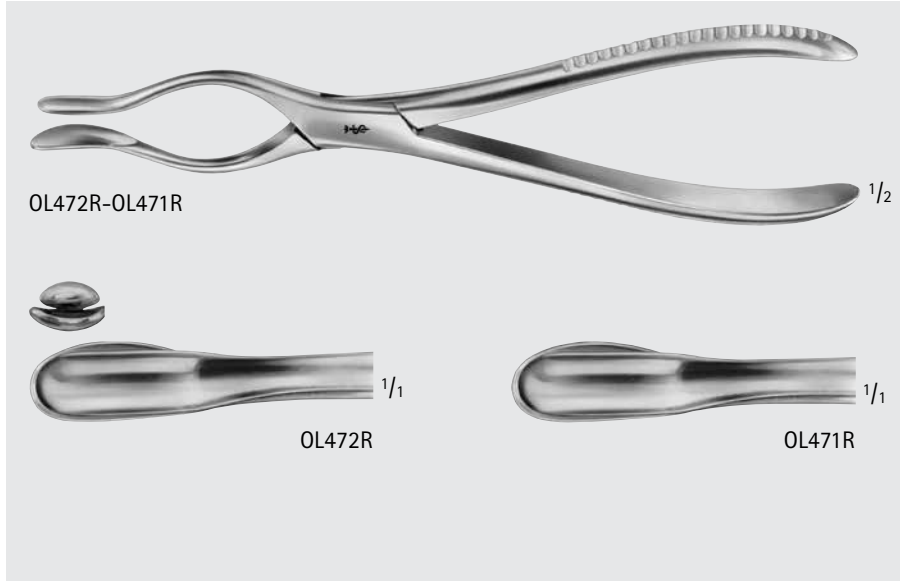

WALSHAM Septum Forceps

Catalog Number	Tip	Length (in.)
OL472R	LEFT	8 3/4
OL471R	RIGHT	8 3/4



OL474R

Septum Morselizer Forceps, W/ Removable Guard

Catalog Number	Length (in.)
OL474R	7 7/8



OL474R

1/1

1/2

Bone and Cartilage Crusher, W/ Clamp

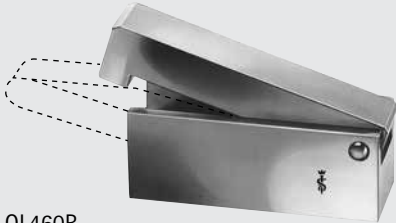

OL460R

Catalog Number
OL460R



ENT
NASAL

INCHES

ENT-NASAL

Nasal Snares and Wires

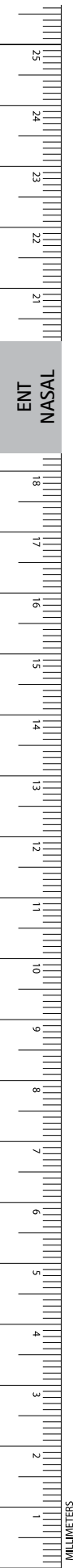

KRAUSE Nasal Polyp Snare, Knee-Shape

Catalog Number	Length (in.)
OK260R	9 3/4



OK260R

WILDE Nasal Polyp Snare

Catalog Number	Tip	Length (in.)
OK270R	BAYO	9 3/4



OK270R

Nasal Snare Wire

Catalog Number	Diameter (mm)	Packaging
OK293R	0.3	100/BOX

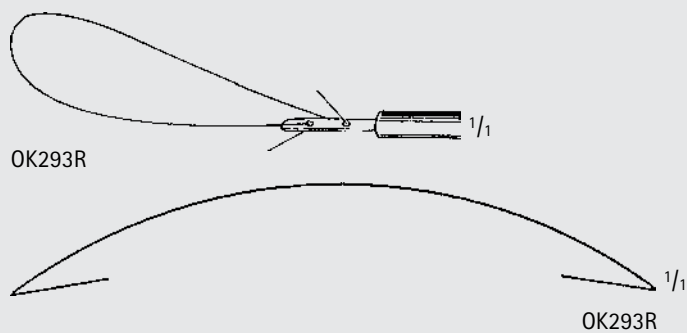

OK293R

OK293R



OL201R

1/2

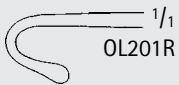

OL201R

1/1

LANGE Fistula Hook

Catalog Number	Tip	Length (in.)
OL201R	BLUNT	9 1/4



MA178R-MA179R

1/2

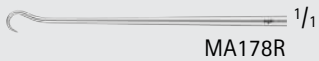

MA178R

1/1

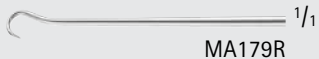

MA179R

1/1

CONVERSE Skin Hooks

Catalog Number	Size	Length (in.)
MA178R	SMALL	7 1/8
MA179R	LARGE	7 1/8



OL207R

1/2



1/1



1/1

OL207R

CONVERSE Double Hook

Catalog Number	Blade Size (mm)	Length (in.)
OL207R	7 x 12 / 8 x 12	4 3/4



MA186R

1/2



MA186R

1/1

MILLARD Double Hook W/ Thimble Mount

Catalog Number	Length (in.)
MA186R	3 1/4

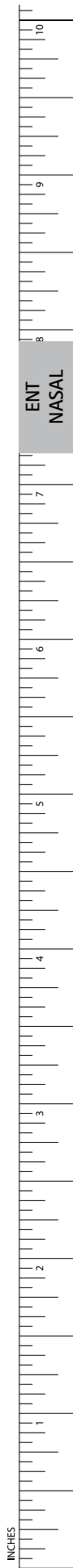

ENT-NASAL

Retractors



OK099R-MA422R

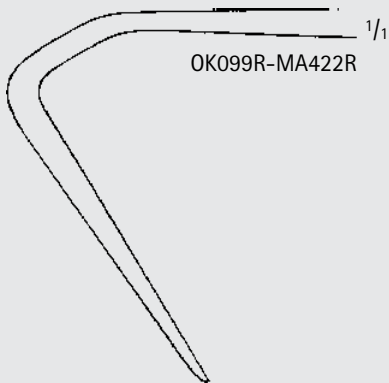

OK099R-MA422R

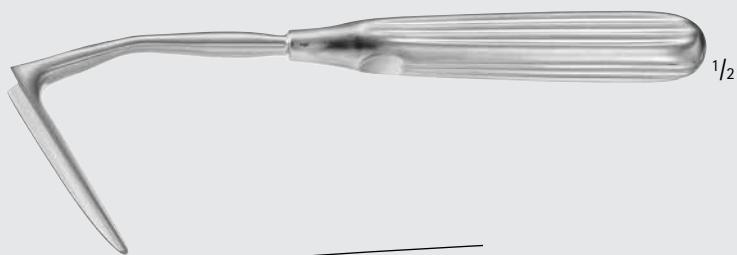

MA423R

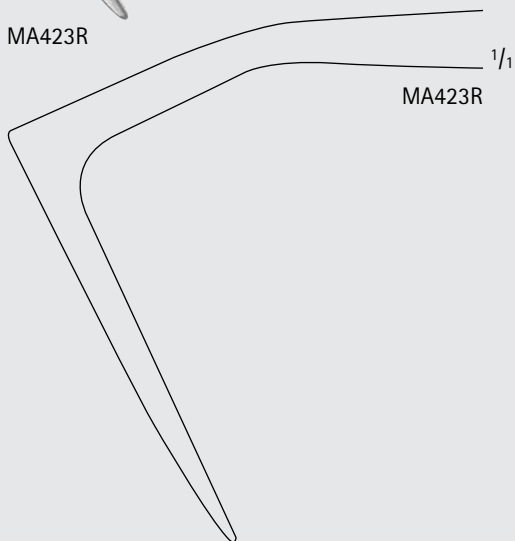

MA423R

AUFRICHT Nasal Retractor

Catalog Number	Blade Size (mm)	Length (in.)
OK099R	10 x 45	6 7/8
MA422R	10 x 45	7 3/8
MA423R	11 x 60	7 3/8

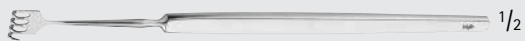

MA424R

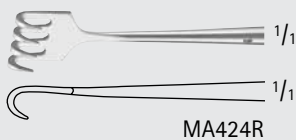

MA424R

Blair Retractor

Catalog Number	Tip	Blade End	Tip Size (mm)	Length (in.)
MA424R	SHARP	4 PRONGS	7	5 1/4

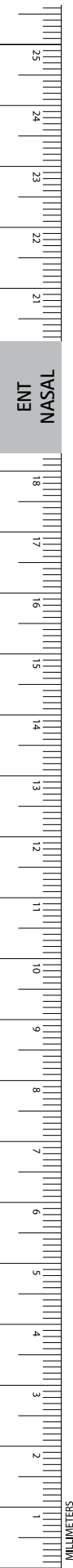

CONVERSE Nasal Retractor

Catalog Number	Blade Size (mm)	Length (in.)
MA425R	9 x 18	3 1/4
MA426R	12 x 21	3 1/4
MA427R	12 x 38	3 1/4
MA428R	12 x 53	3 1/4
MB107R	44 x 11	4 1/2



MA425R

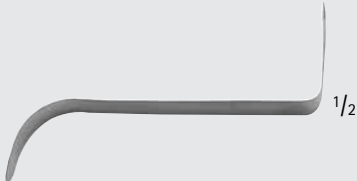

MA426R



MA427R

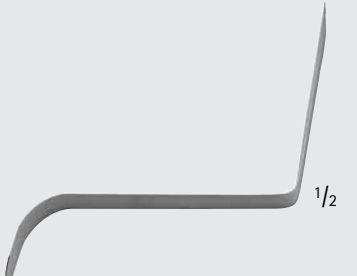

MA428R



MB107R

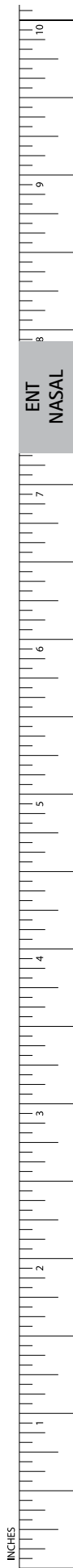

ENT-NASAL

Retractors



MA430R



MA430R

COTTLE Nasal Retractor

Catalog Number	Tip	Blade End	Tip Size (mm)	Length (in.)
MA430R	BLUNT	4 PRONGS	10	5 1/8



OL214R



1/1



OL214R

COTTLE Nasal Retractor, Double Ended

Catalog Number	Blade Size (mm)	Tip	Length (in.)
OL214R	12 x 5 / 4 x 4.5	BALL END/ BLUNT	7 7/8



OL203R-OL204R



OL203R



OL204R

COTTLE Retractor

Catalog Number	Tip	Length (in.)
OL203R	BLUNT/RIGHT SHARP	5 3/4
OL204R	LEFT SHARP/BLUNT	5 3/4

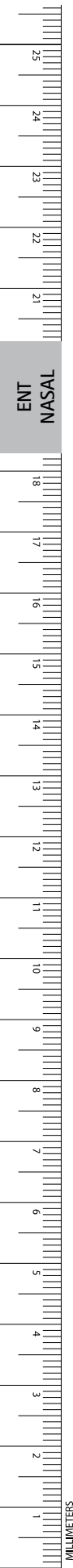



OL212R



OL212R



OL211R



OL211R

COTTLE Alar (MASING) Retractor

Catalog Number	Blade Size (mm)	Length (in.)
OL211R	6 x 12	5 1/2
OL212R	10 x 12	5 1/2



OL202R

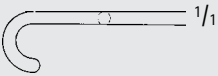

OL202R



MA431R



MA431R

FOMON Retractor

Catalog Number	Tip Size (mm)	Tip	Blade End	Length (in.)
OL202R	12	BLUNT	2 PRONGS	5 3/4
MA431R	13	BALL END	2 PRONGS	6 1/4

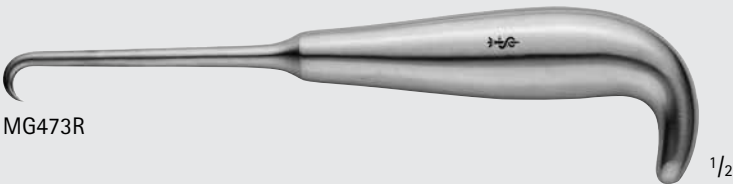

MG473R

GILLIES Bone and Zygoma Hook

Catalog Number	Tip Size (mm)	Length (in.)
MG473R	9	7 1/4



ENT-NASAL

Retractors

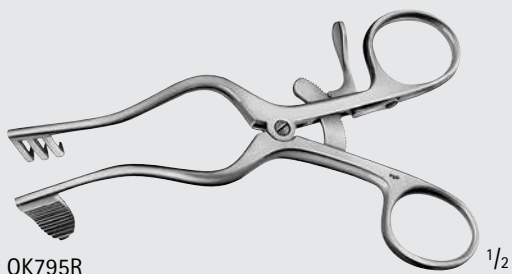

OK795R $\frac{1}{2}$

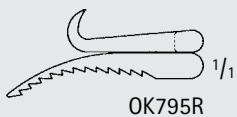

OK795R $\frac{1}{1}$

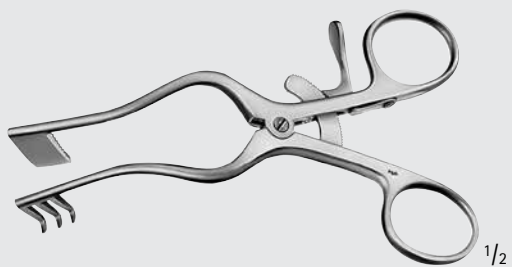

$\frac{1}{2}$

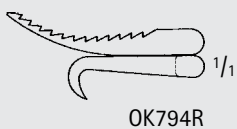

OK794R $\frac{1}{1}$



$\frac{1}{1}$

PERKINS Antrum Retractor

Catalog Number	Right Blade	Left Blade	Length (in.)
OK795R	3 PRONGS	SOLID	5
OK794R	SOLID	3 PRONGS	5

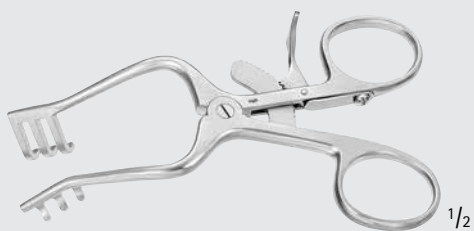

MA438R $\frac{1}{2}$

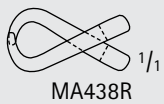

MA438R $\frac{1}{1}$

Baby WEITLANER Retractor

Catalog Number	Tip	Blade End	Length (in.)
MA438R	BLUNT	3 x 3 PRONGS	4 1/4



MB054R



MB054R

WULLSTEIN Retractor

Catalog Number	Tip	Blade End	Length (in.)
MB054R	BLUNT	3 x 3 PRONGS	4 1/4



BV030R



BV030R



BV032R



BV032R



BV033R

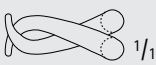

BV033R

JANSEN Retractor

Catalog Number	Tip	Blade End	Length (in.)
BV030R	SHARP	3 x 3 PRONGS	4
BV032R	BLUNT	3 x 3 PRONGS	4
BV033R	BLUNT	3 x 4 PRONGS	4

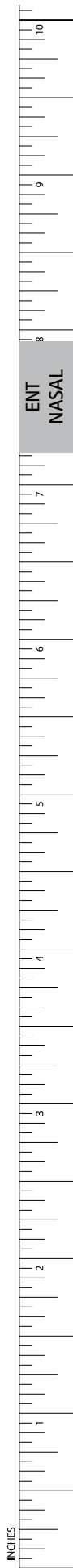

INCHES

ENT-NASAL

Elevators and Dissectors



OL477R

BOIES Nasal Fracture Elevator

Catalog Number	Tip	Length (in.)
OL477R	BLUNT	7



OL479R

GOLDMANN Septum Displacer

Catalog Number	Tip	Length (in.)
OL479R	STR	7 7/8

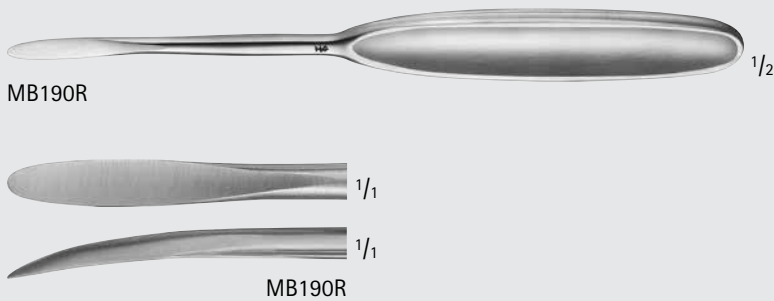

MB190R

CUSHING Elevator, Narrow

Catalog Number	Tip Size (mm)	Tip	Length (in.)
MB190R	8	SHARP	7 3/4

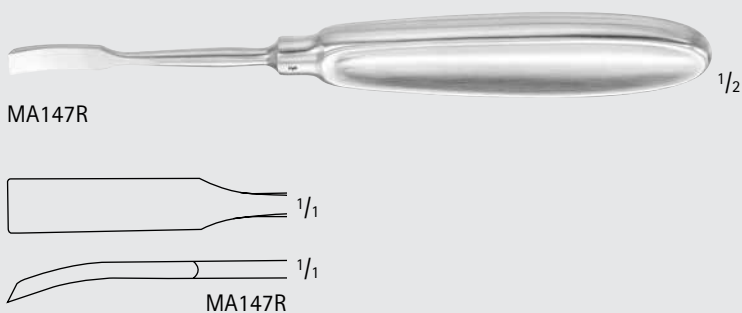

MA147R

LEMPERT Elevator

Catalog Number	Tip Size (mm)	Blade	Length (in.)
MA147R	7	CVD	7 1/4

ENT
NASAL



MA145R-MA146R

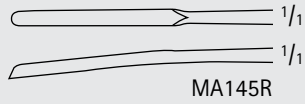

MA145R

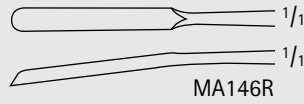

MA146R

LEMPERT Elevator

Catalog Number	Tip	Tip Size (mm)	Length (in.)
MA145R	SLIGHT CVD	2	6 3/4
MA146R	SLIGHT CVD	3	6 3/4
OG163R	STR	3	7 1/2
OG164R	BROAD, SLIGHT CVD	6	7 1/4



OG163R

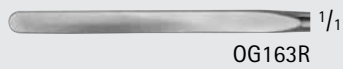

OG163R



OG164R

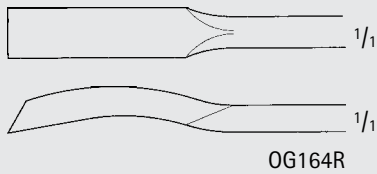

OG164R



MA290R



MA290R

KLEINERT-KUTZ Elevator and Dissector, Double Ended

Catalog Number	Tip Size (mm)	Length (in.)
MA290R	2/4	7



OL192R

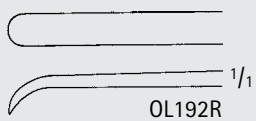

OL192R

MCKENTY Periosteal Elevator

Catalog Number	Tip	Tip Size (mm)	Length (in.)
OL192R	CVD, SHARP	4.0	6



ENT
NASAL

INCHES

ENT-NASAL

Elevators and Dissectors

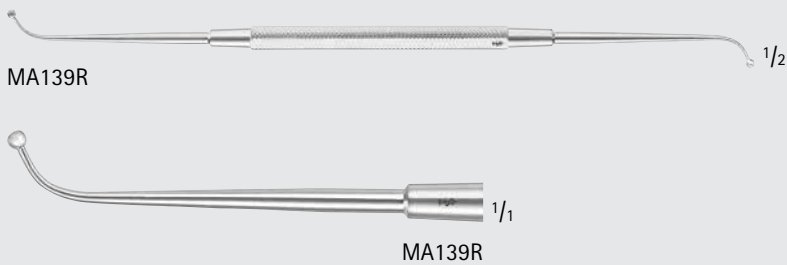

Ball End Elevator, Double Ended

Catalog Number	Blade Shape	Length (in.)
MA139R	ANG	7 1/2

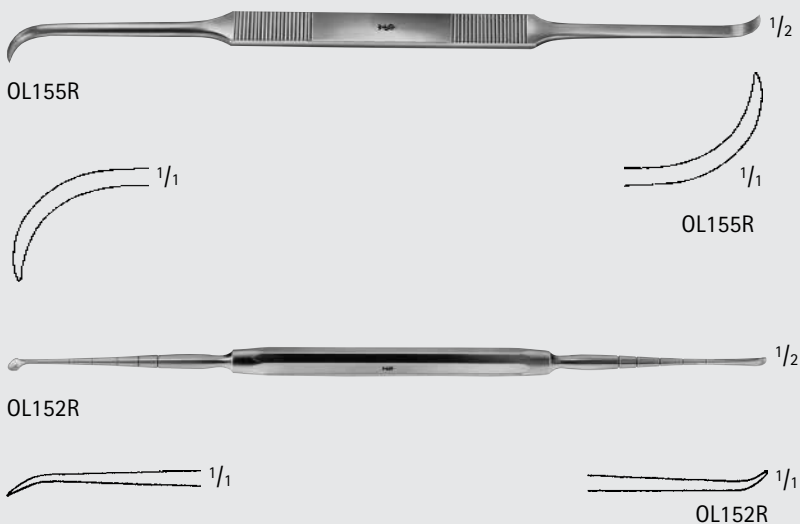

COTTLE Elevator, Double Ended

Catalog Number	Blade	Length (in.)
OL155R	-	7 7/8
OL152R	GRADUATED	7 7/8

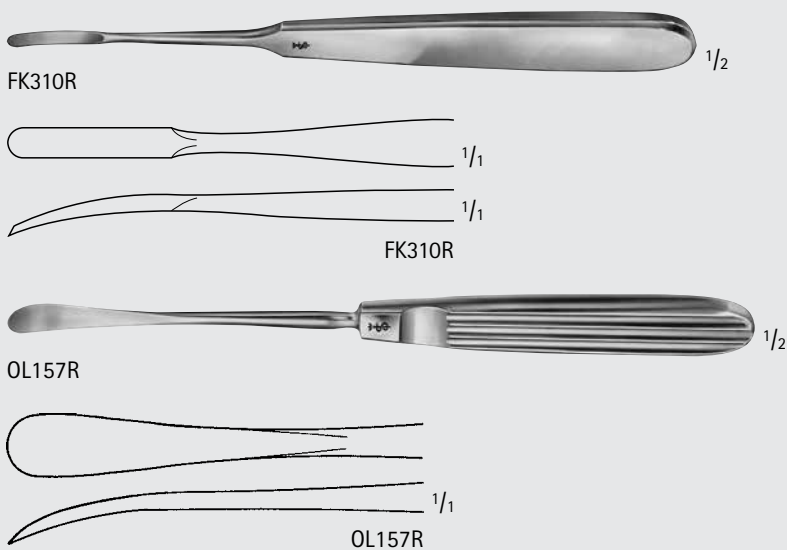

COTTLE Periosteal Elevator

Catalog Number	Tip	Width (mm)	Length (in.)
FK310R	SLIGHTLY CVD	4	7
OL157R	CVD, SHARP	8	7 3/4

ENT
NASAL

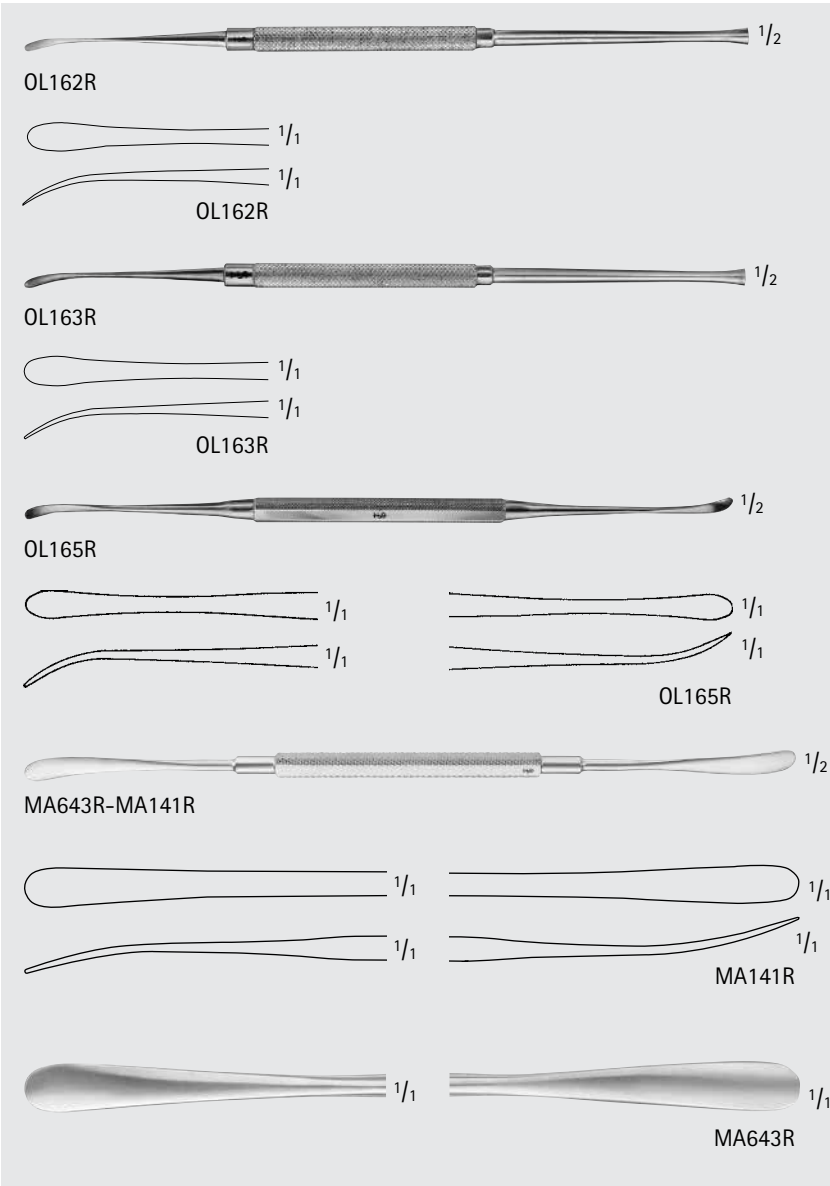

FREER Elevator

Catalog Number	Tip	Tip Size (mm)	Length (in.)
OL162R	SINGLE ENDED SHARP	4	7 1/2
OL163R	SINGLE ENDED BLUNT	4	7 1/2
OL165R	SHARP/BLUNT	4 / 4	7 1/4
MA643R	SHARP/BLUNT	4.5 / 4.5	7 1/2
MA141R	SHARP/BLUNT	6.5	7 1/2

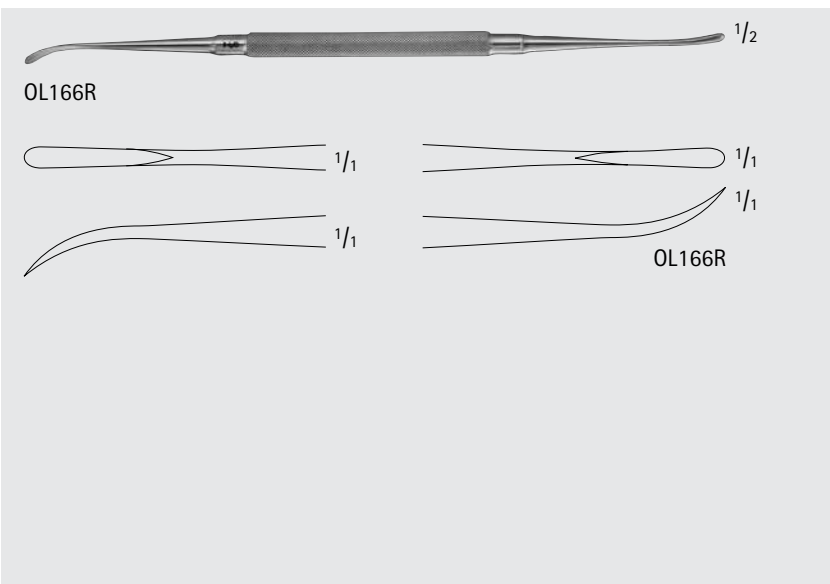

FREER-YASARGIL Elevator

Catalog Number	Tip	Length (in.)
OL166R	SHARP/SHARP	7 1/4



ENT-NASAL

Elevators and Dissectors



OL198R

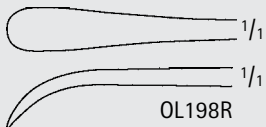

OL198R

SEWALL Antrum Elevator

Catalog Number	Tip	Tip Size (mm)	Length (in.)
OL198R	BLUNT	5.9	7 7/8



MB297R

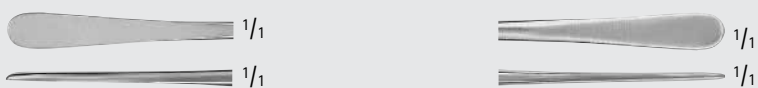

MB297R

HAJEK-BALLENGER Septum Elevator and Dissector, Double Ended

Catalog Number	Tip	Length (in.)
MB297R	SHARP/BLUNT	7 1/2



OL153R

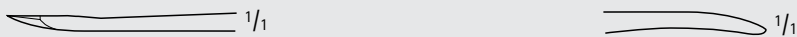

OL153R

COTTLE (MASING) Elevator, Graduated

Catalog Number	Blade	Length (in.)
OL153R	DBL ENDED	7 7/8



OL151R

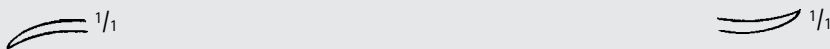

OL151R

PENNINGTON Elevator

Catalog Number	Tip	Length (in.)
OL151R	SHARP/SHARP	8 1/4



MB313R

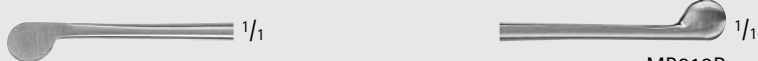

MB313R

PIERCE Submucous Dissector

Catalog Number	Length (in.)
MB313R	7 1/2



MB312R

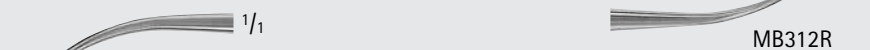

MB312R

ROGERS Submucous Dissector

Catalog Number	Length (in.)
MB312R	8 3/4



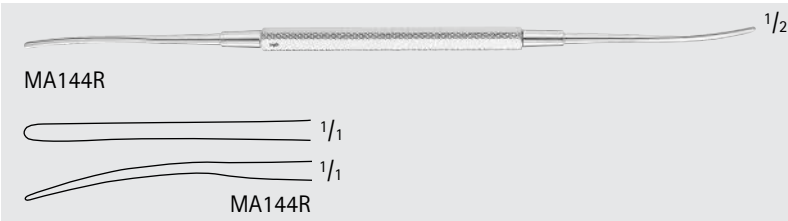

HENNER Elevator, Double Ended

Catalog Number	Tip Size (mm)	Length (in.)
MA144R	2/2	8 1/2

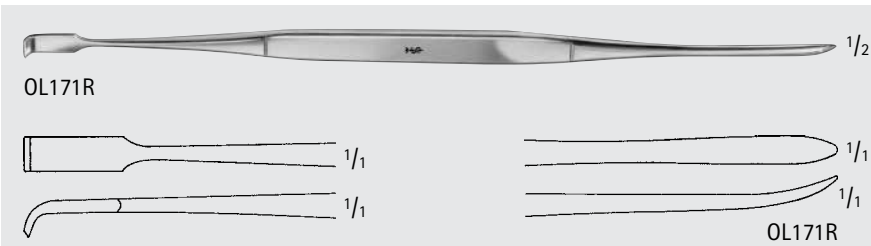

HOWARTH Elevator, Double Ended

Catalog Number	Tip	Length (in.)
OL171R	SHARP/BLUNT	8 1/2

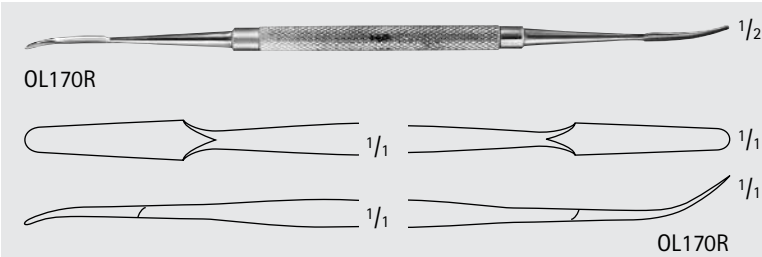

KILLIAN Elevator, Double Ended

Catalog Number	Tip	Length (in.)
OL170R	SHARP/BLUNT	7 1/4

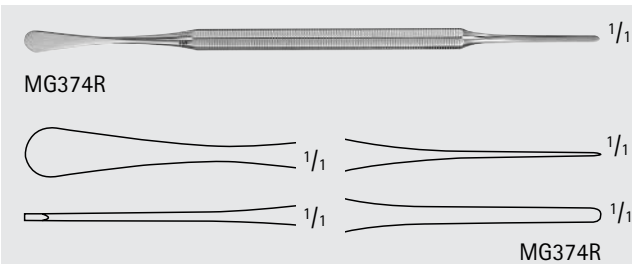

Spatula and Packer, Double Ended

Catalog Number	Length (in.)
MG374R	5 3/4

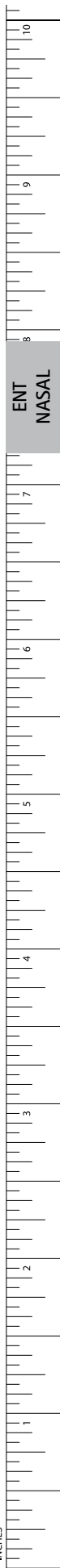

INCHES

ENT-NASAL

Elevators and Dissectors



OL160R

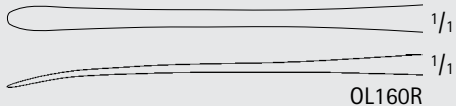

HALLÉ Elevator

Catalog Number	Tip	Tip Size (mm)	Length (in.)
OL160R	BLUNT	3.3	7



OM307, OM309R, OM308R

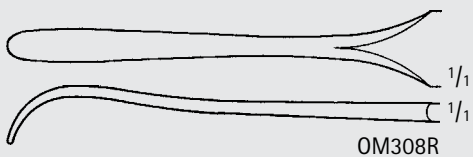
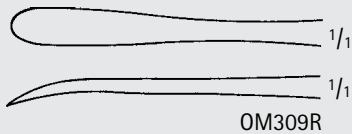

KOENIG Elevator

Catalog Number	Tip	Tip Size (mm)	Length (in.)
OM307R	SLIGHTLY CVD	4.5	6 1/8
OM309R	SLIGHTLY CVD	4.5	6 1/8
OM308R	STRONGLY CVD	4.5	6 1/8



MA143R



OBWEGESER-FREER Elevator

Catalog Number	Tip	Tip Size (mm)	Blade Shape	Length (in.)
MA143R	BLUNT	6	DBL ENDED	8 1/2

ENT
NASAL

MILLIMETERS

COTTLE Septum Speculum

Catalog Number	Blade Size (mm)	Blade Shape	W/ Set Screw	Length (in.)
OK085R	50 x 6	TAPERED	NO	5 1/4
OK089R	76 x 7	THIN	YES	5 1/4
OK090R	90 x 7	THIN	YES	5 1/4



OK085R

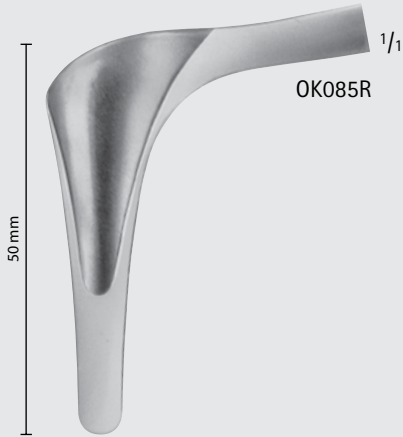

OK085R



OK089R-OK090R

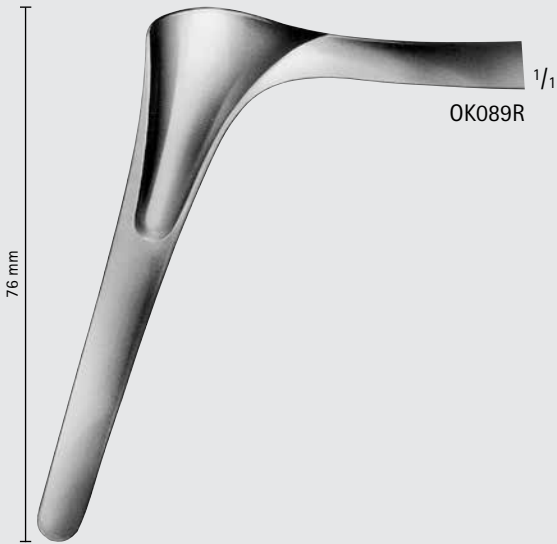

OK089R

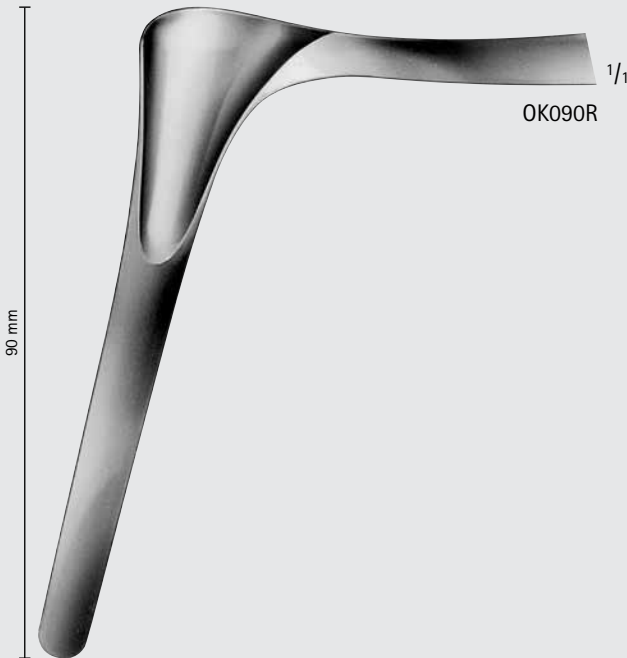

OK090R

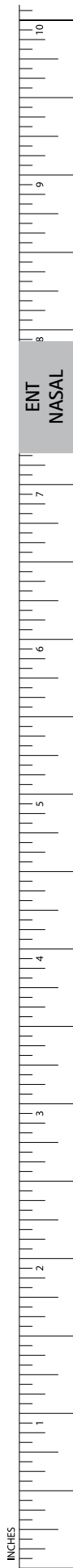

ENT-NASAL

Specula

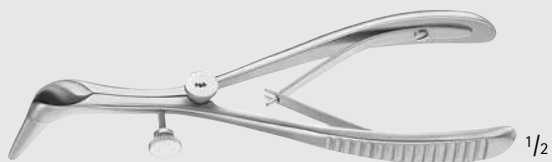

OK105R-OK108R

COTTLE Nasal Speculum

Catalog Number	Blade Size (mm)	Blade Shape	Size (#)	Length (in.)
OK105R	20	Xtra Thin	1	5 1/4
OK106R	38	Xtra Thin	2	5 1/4
OK107R	41	Xtra Thin	3	5 1/4
OK108R	60	Xtra Thin	4	5 1/4

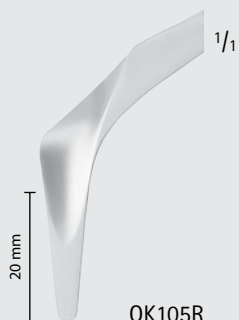

OK105R



OK106R



OK107R

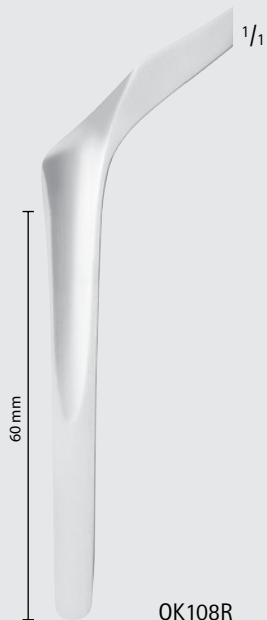

OK108R

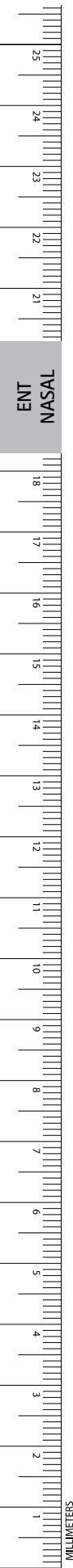

COTTLE Septum Speculum (continued)

Catalog Number	Blade Size (mm)	Blade Shape	Length (in.)
MA346R	50	THIN	5 5/8



MA346R

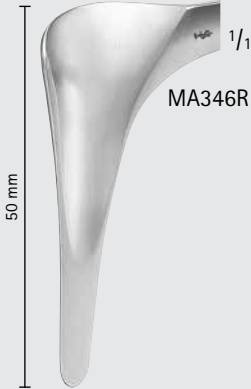

KILLIAN Septum Speculum, Aseptic

Catalog Number	Blade Size (mm)	Length (in.)
OK081R	36 x 7	5 1/2
OK082R	56 x 7	5 1/2
OK083R	75 x 7	5 1/2
OK084R	90 x 7	5 1/2



OK081R-OK084R

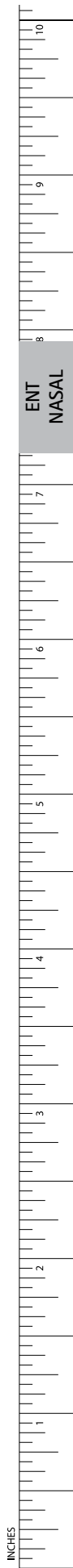
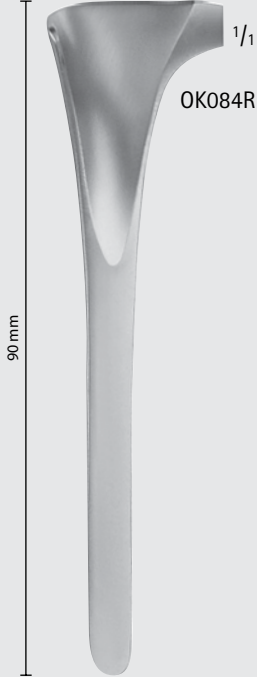
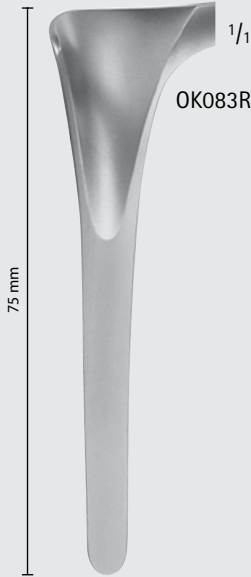
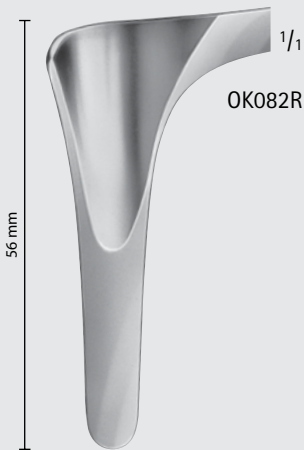
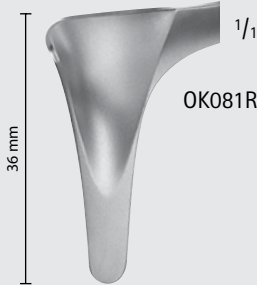

ENT-NASAL

Specula



OK091R-OK094R

KILLIAN Septum Speculum W/ Screw Joint

Catalog Number	Blade Size (mm)	Length (in.)
OK091R	36 x 7	5 3/4
OK092R	56 x 7	5 3/4
OK093R	75 x 7	5 3/4
OK094R	90 x 7	5 3/4

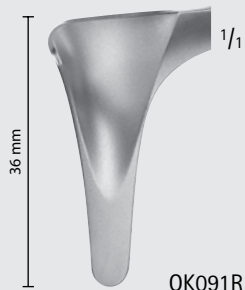

OK091R

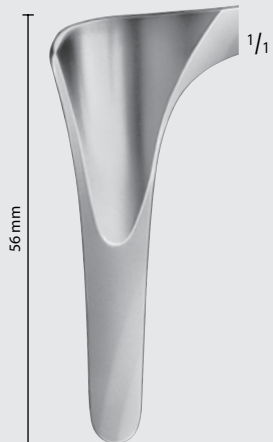

OK092R

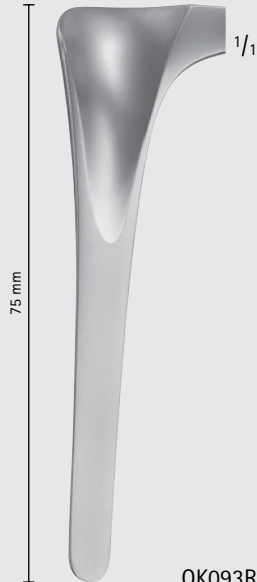

OK093R

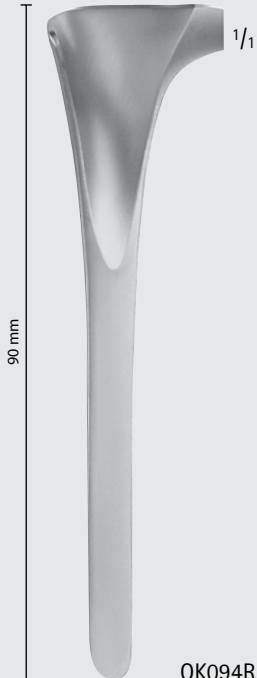

OK094R

ENT
NASAL

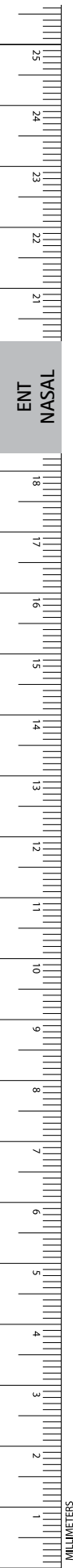

VIENNA Nasal Speculum

Catalog Number	Blade Size	Length (in.)
OK060R	SMALL	5 1/2
OK061R	MEDIUM	5 1/2
OK062R	LARGE	5 1/2



OK060R



OK060R



OK061R

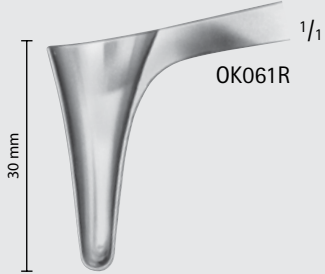

OK061R



OK062R

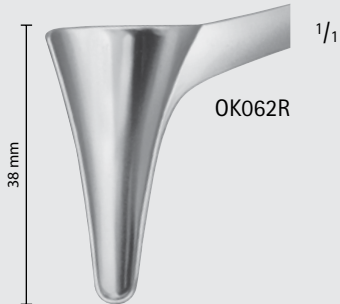

OK062R

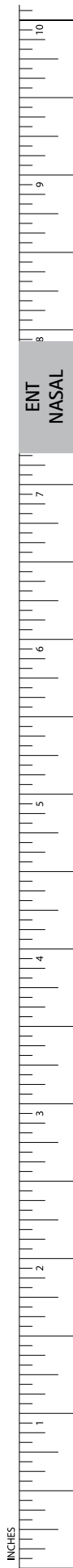

ENT-NASAL

Specula



MA348R-MA350R

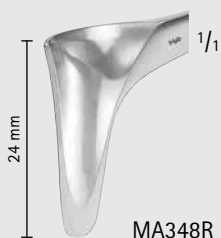

MA348R

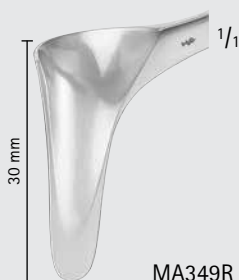

MA349R

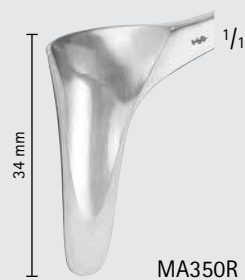

MA350R

VIENNA Nasal Speculum (continued)

Catalog Number	Blade Size (mm)	Tip Size (mm)	Length (in.)
MA348R	24	1	5 1/4
MA349R	30	3	5 1/4
MA350R	34	4	5 1/4



OK030R



OK030R



OK041R-OK043R



OK041R

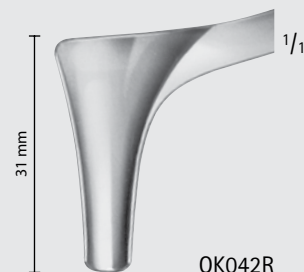

OK042R



OK043R

HARTMANN Nasal Speculum

Catalog Number	Blade Size	Length (in.)
OK030R	LIGHT	5 3/4
OK041R	SMALL	6 1/4
OK042R	MEDIUM	6 1/4
OK043R	LARGE	6 1/4

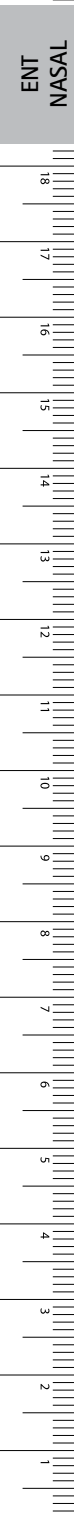



OK047R-OK049R

HARTMANN-HALLE Nasal Speculum W/ Screw Joint

Catalog Number	Blade Size	Length (in.)
OK047R	SMALL	6 1/8
OK048R	MEDIUM	6 1/8
OK049R	LARGE	6 1/8

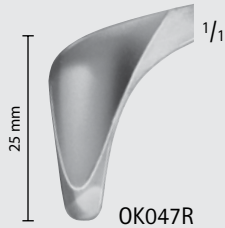

OK047R

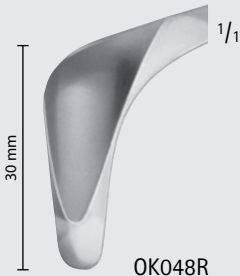

OK048R

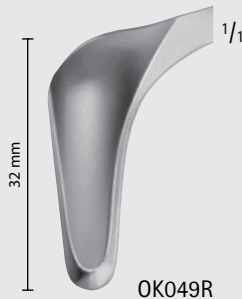

OK049R



OK051R-OK052R

TIECK-HALLE Nasal Speculum W/ Screw Joint, Pediatric

Catalog Number	Blade Size	Length (in.)
OK051R	SMALL	5 1/4
OK052R	LARGE	5 1/4



OK051R

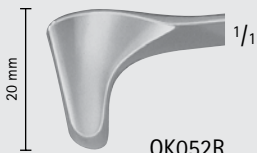

OK052R

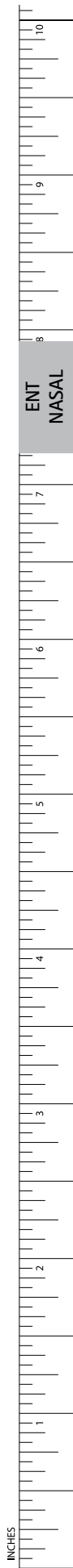

ENT-NASAL

Specula

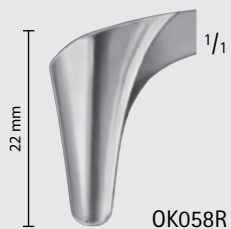

BECKMANN Nasal Speculum W/ Screw Joint, Pediatric

Catalog Number	Blade Size	Blade Shape	Length (in.)
OK053R	SMALL	LAT-CVD	5 1/2
OK058R	MEDIUM	LAT-CVD	6

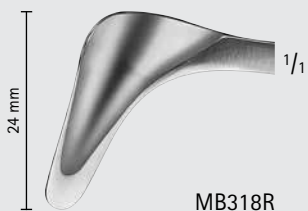
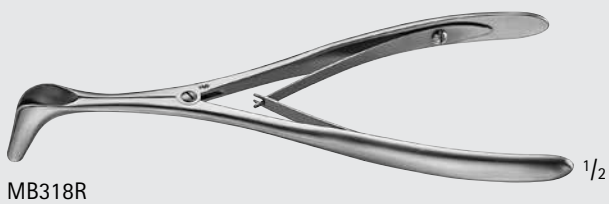

SONNENSCH EIN Nasal Speculum

Catalog Number	Blade Size	Length (in.)
MB318R	MEDIUM	6

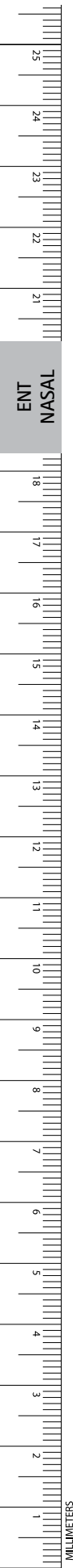



OK100R-OK102R



OK103R

CUSHING-LANDOLT Transssphenoidal Speculum

Catalog Number	Blade Size (mm)	Length (in.)
OK100R	70 x 15	-
OK101R	90 x 15	-
OK102R	110 x 15	-
OK103R	SPREADER FOR OK100R-OK102R	8 1/4



FF589R-FF591R



TE749R



FF595R

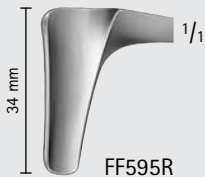

FF595R

PAPAVERO-HARTMANN (CASPAR) Transssphenoidal Speculum, Slim, W/ Key

Catalog Number	Blade Size (mm)	Description	Length (in.)
FF589R	80 x 11	-	-
FF590R	90 x 13	-	-
FF591R	100 x 15	-	-
TE749R	-	HEX KEY	-
FF595R	34 x 9	SPREADER FOR FF589R-FF591R	5 1/2

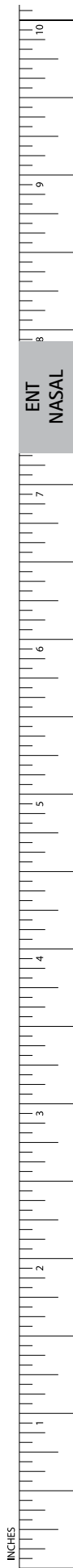

ENT-NASAL

Rasps, Files and Saws

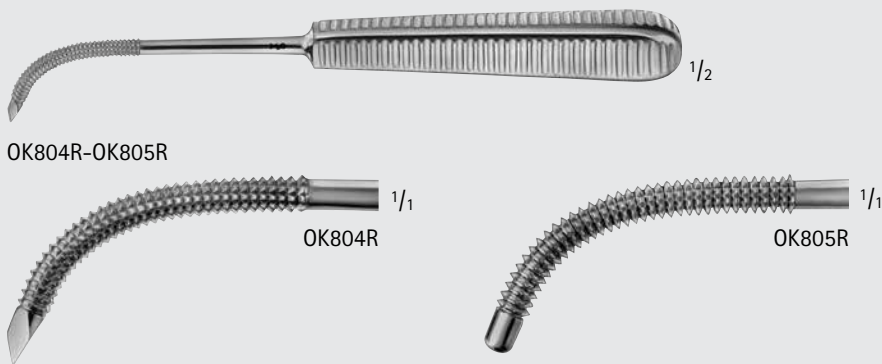

Antrum Rasp

Catalog Number	Tip	Length (in.)
OK804R	SHARP	7
OK805R	BLUNT	7



WEINER Antrum Rasp Trocar

Catalog Number	Tip	Length (in.)
MA421R	EXTRA SMALL, TROCAR	7 3/8

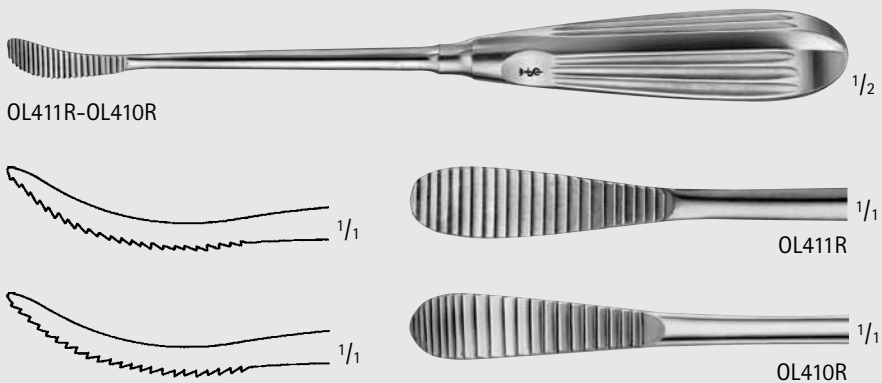

AUFRICHT Nasal Rasp

Catalog Number	Tip Size (mm)	Tip	Length (in.)
OL411R	9	DOWN-CUT	8 3/4
OL410R	9	UP-CUT	8 3/4



COTTLE Rasp

Catalog Number	Tip	Length (in.)
MA706R	DOWN CUTTING	8 1/4

ENT
NASAL

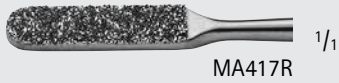

Diamond Dust Rasp

Catalog Number	Tip	Length (in.)
MA417R	STR	7 3/8
MA416R	CVD	7 3/8

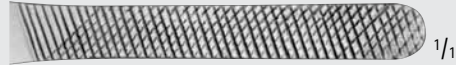
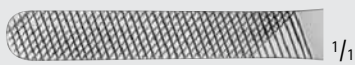

OL405R

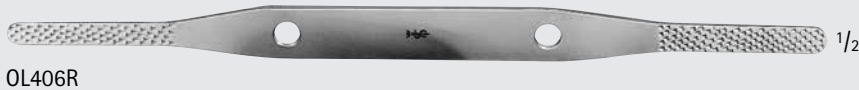

OL406R

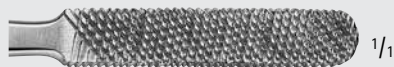
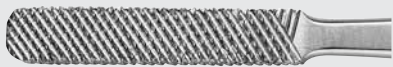

MG584R



MA418R

FOMON Bone Rasp, Double Ended

Catalog Number	Tip Size (mm)	Tip	Length (in.)
OL405R	6.5 / 7.5	X-SERR Fine/Coarse	8 1/2
OL406R	6.5 / 7.5	Fine/Coarse	8 1/2
MG584R	8/8	FLAT, CONVEX FINE, COARSE	8 1/2
MA418R	7.5 / 7.5	Coarse/ Xtra-Coarse	8 3/8



GALLAHER File Rasp, Coarse

Catalog Number	Tip Size (mm)	Length (in.)
OL412R	6.5	7 1/2



ENT-NASAL

Rasps, Files and Saws



OL448R



OL451R

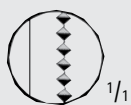

OL452R

JOSEPH Nasal Saw, Bayonet

Catalog Number	Blade Shape	Length (in.)
OL448R	STR	7 3/4
OL451R	CVD RIGHT	7 3/4
OL452R	CVD LEFT	7 3/4



OL401R-OL403R



OL401R



OL403R

JOSEPH Nasal Saw

Catalog Number	Tip	Tip Size (mm)	Length (in.)
OL401R	FINE-SERR	7.5	6 1/2
OL403R	COARSE-SERR	9	6 1/2



OL408R-OL409R

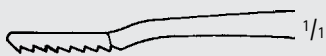

OL408R



OL409R

LEWIS Bone Rasp

Catalog Number	Tip	Tip Size (mm)	Length (in.)
OL408R	FINE-SERR DOWN-STROKE	8	6 7/8
OL409R	COARSE-SERR DOWN-STROKE	8	6 7/8

ENT
NASAL

MILLIMETERS



MB110R



MB110R

MALTZ-ANDERSON Nasal Rasp

Catalog Number	Tip Size (mm)	Length (in.)
MB110R	5.7	6 1/2



OL407R

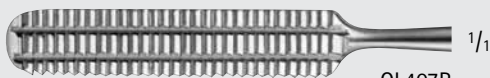

OL407R



MA419R



MA419R



MA420R



MA420R

MALTZ Bone Rasp

Catalog Number	Tip Size (mm)	Tip	Length (in.)
OL407R	9	DOWN-STROKE	6 1/2
MA419R	33	DOWN-STROKE	6 1/2
MA420R	33	UP STROKE	6 1/2



MB330R



MB330R

PARKES Nasal Rasp

Catalog Number	Tip Size (mm)	Length (in.)
MB330R	8	7 7/8

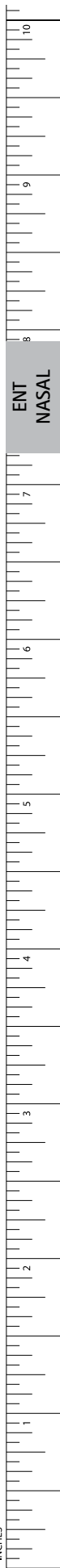

INCHES

ENT-NASAL

Chisels and Gouges

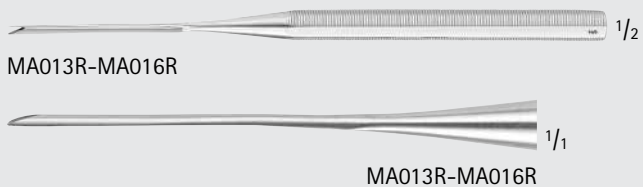

BALLENGER Chisel, V-shaped

Catalog Number	Tip Size (mm)	Length (in.)
MA013R	2	5 7/8
MA014R	4	5 7/8
MA016R	8	5 7/8

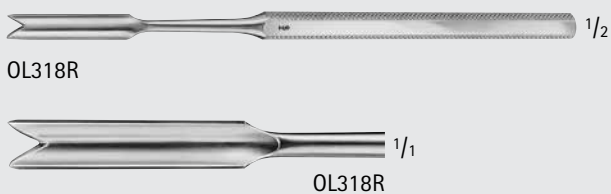

BALLENGER Septum Gouge

Catalog Number	Tip Size (mm)	Length (in.)
OL318R	6	6

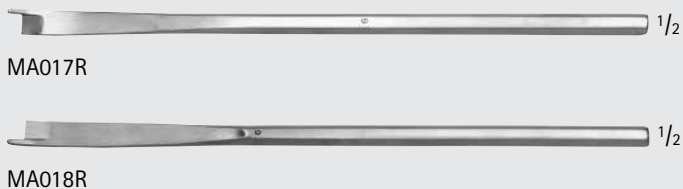

CONVERSE Guarded Chisel

Catalog Number	Tip Size (mm)	Blade Shape	Length (in.)
MA017R	6	CVD RIGHT	7 1/2
MA018R	6	CVD LEFT	7 1/2



COTTLE Chisel W/ Depth Marks

Catalog Number	Tip Size (mm)	Length (in.)
OL301R	4	7
OL302R	7	7
OL303R	9	7
OL304R	12	7



OL311R

1/2

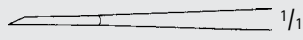

OL311R

1/1



OL314R

1/2

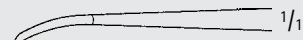

OL314R

1/1

FREER Chisel

Catalog Number	Tip Size (mm)	Blade Shape	Length (in.)
OL311R	4	STR	6 1/4
OL314R	4	CVD	6 1/4



FF610R

1/2

PAPAVERO Bayonet Chisel

Catalog Number	Tip Size (mm)	Length (in.)
FF610R	4	8 3/4



OL316R

1/2

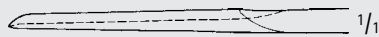

OL316R

1/1

FREER Septum Gouge

Catalog Number	Tip Size (mm)	Length (in.)
OL316R	4	6



OL336R

1/2



OL336R

1/1

KILLIAN Septum Gouge, Bayonet

Catalog Number	Tip Size (mm)	Length (in.)
OL336R	6	6 3/4



MB108R, MA629R

1/2



MB108R, MA629R

1/1

PARKES Hump Gouge, Double Guard

Catalog Number	Tip Size (mm)	Blade Shape	Length (in.)
MB108R	10	STR	7
MA629R	6	STR	7



ENT
NASAL

INCHES

ENT-NASAL

Osteotomes



MA382R

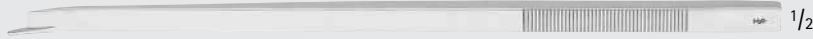

MA381R

ANDERSON-NEIVERT Osteotome

Catalog Number	Tip Size (mm)	Blade Shape	Length (in.)
MA382R	5	CVD RIGHT	8
MA381R	5	CVD LEFT	8



MB590R-MB594R

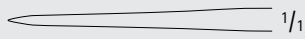

MB590R-MB594R

CHERRY Osteotome

Catalog Number	Tip Size (mm)	Length (in.)
MB590R	3	8
MB591R	4	8
MB592R	5	8
MB593R	6	8
MB594R	7	8



MA369R

CINELLI Osteotome, Double Guard

Catalog Number	Tip Size (mm)	Blade Shape	Length (in.)
MA369R	10	CVD	6 1/8





OL326R-OL329R



OL326R



OL327R



OL328R



OL329R

CINELLI Osteotome, Double Guard

Catalog Number	Tip Size (mm)	Blade	Length (in.)
OL326R	10	STR	6 1/4
OL327R	12	STR	6 1/4
OL328R	14	STR	6 1/4
OL329R	16	STR	6 1/4



MB398R-MB403R



MB398R-MB403R

CONVERSE Osteotome

Catalog Number	Tip Size (mm)	Length (in.)
MB398R	2	7
MB399R	4	7
MB400R	6	7
MB401R	8	7
MB402R	10	7
MB403R	12	7

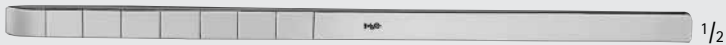

OL294R-OL300R

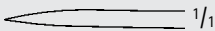

OL294R-OL300R

COTTLE Osteotome, W/ Depth Mark

Catalog Number	Tip Size (mm)	Length (in.)
OL294R	4	7
OL296R	6	7
OL298R	8	7
OL299R	10	7
OL300R	12	7

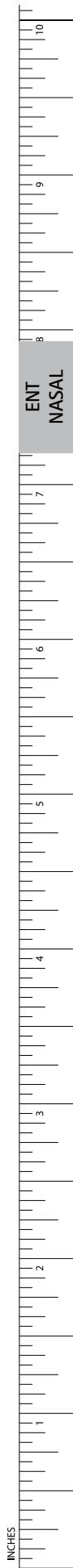

ENT-NASAL

Osteotomes

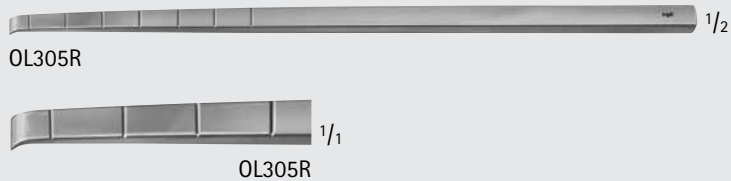

COTTLE Osteotome, Curved

Catalog Number	Tip Size (mm)	Length (in.)
OL305R	6	7

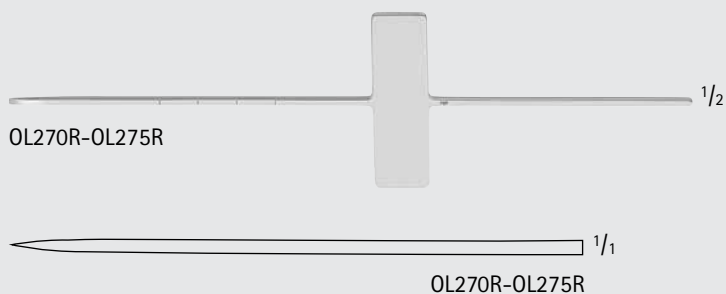

COTTLE Osteotome W/ Cross Bar

Catalog Number	Tip Size (mm)	Blade Shape	Length (in.)
OL270R	2	STR	7
OL271R	4	STR	7
OL272R	6	STR	7
OL273R	7	STR	7
OL274R	9	STR	7
OL275R	12	STR	7



TESSIER Osteotome

Catalog Number	Tip Size (mm)	Blade Shape	Length (in.)
OL360R	2.5	STR	6 1/4
OL361R	3.5	STR	6 1/4
OL362R	5	STR	6 1/4
OL366R	7	STR	6 1/4
OL368R	10	STR	6 1/4
OL370R	14	STR	6 1/4
OL371R	18	STR	6 1/4
OL363R	5	CVD	6 1/4
OL367R	7	CVD	6 1/4
OL369R	10	CVD	6 1/4

ENT
NASAL

1
2
3
4
5
6
7
8
9
10
11
12
13
14
15
16
17
18
19
20
21
22
23
24
25
MILLIMETERS

DAUTREY Osteotome

Catalog Number	Tip Size (mm)	Blade Shape	Length (in.)
OL344R	4	STR	6 3/4
OL345R	6	STR	6 3/4
OL346R	6	SLIGHTLY CVD	6 3/4
OL347R	6	STRONGLY CVD	6 3/4
OL348R	8	STR	6 3/4
OL349R	8	SLIGHTLY CVD	6 3/4
OL350R	8	STRONGLY CVD	6 3/4

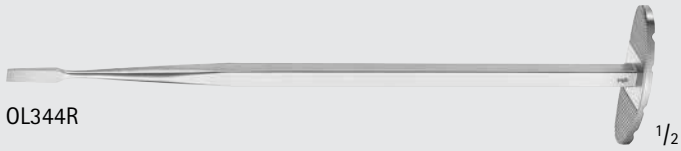

OL344R

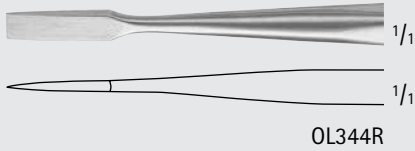

OL344R

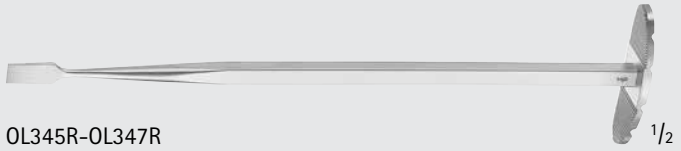

OL345R-OL347R

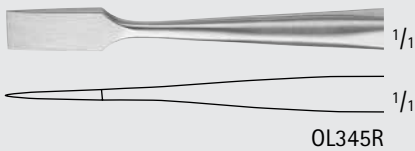

OL345R

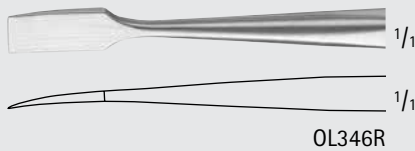

OL346R

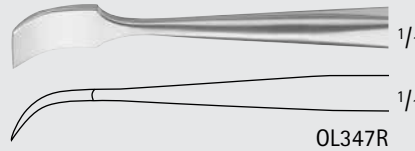

OL347R



OL348R-OL350R

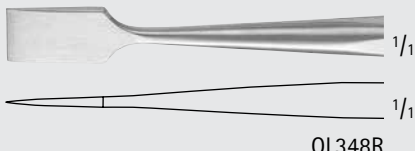

OL348R

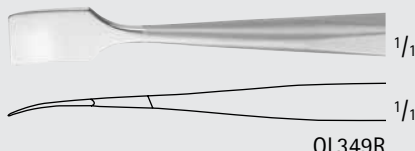

OL349R

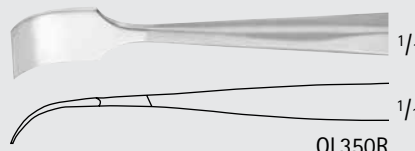

OL350R

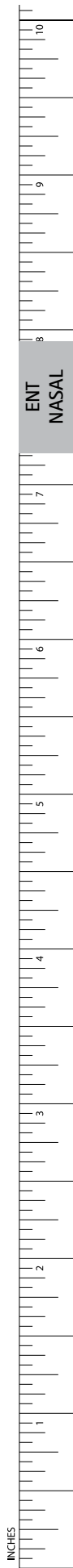

ENT-NASAL

Osteotomes



OL338R-OL339R

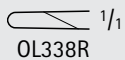

OL338R

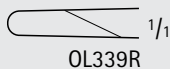

OL339R

FOMON Osteotome, Single Guard

Catalog Number	Tip Size (mm)	Length (in.)
OL338R	5	6 3/4
OL339R	8	6 3/4



OL323R



OL321R



OL322R

MASING Osteotome, Single Guard

Catalog Number	Blade	Length (in.)
OL323R	STR	6 7/8
OL321R	LEFT-CVD	6 7/8
OL322R	RIGHT-CVD	6 7/8



MA332R



MA333R



MA334R

OBEWESGESER Nasal Osteotome

Catalog Number	Tip Size (mm)	Length (in.)
MA332R	6	7 1/4
MA333R	8	7 1/4
MA334R	4	7 1/2

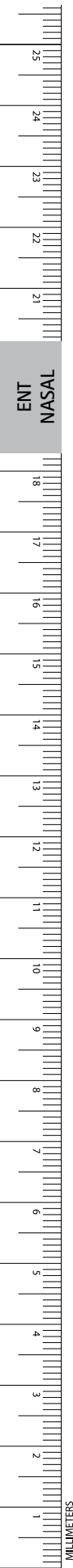



MB404R-MB373R



MB404R-MB373R

Osteotome W/ Hexagonal Handle

Catalog Number	Tip Size (mm)	Length (in.)
MB404R	2	6 1/4
MB405R	3	6 1/4
MB406R	4	6 1/4
MB407R	5	6 1/4
MB408R	6	6 1/4
MB409R	7	6 1/4
MB410R	8	6 1/4
MB411R	9	6 1/4
MB412R	10	6 1/4
MB413R	11	6 1/4
MB373R	12	6 1/4



MA384R

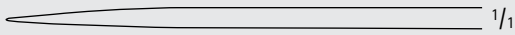

MA384R



MB388R



MB389R

RUBIN Osteotome, W/ Finger Grip

Catalog Number	Tip Size (mm)	Length (in.)
MA384R	14	6 1/4
MB388R	10	6 1/2
MB389R	14	6 1/2

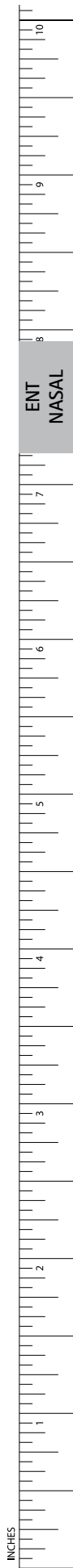

ENT-NASAL

Applicators and Probes

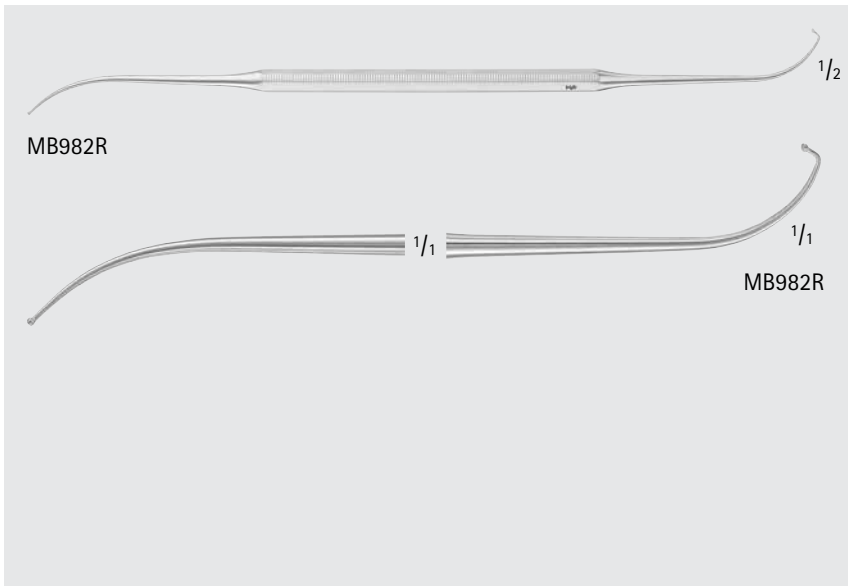
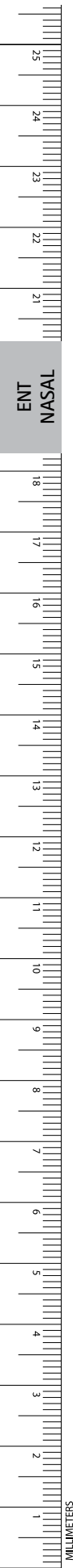

Frontal Ostium Seeker Probe, Double Ended

Catalog Number	Tip	Length (in.)
MB982R	CVD RIGHT, ANG	8 1/4

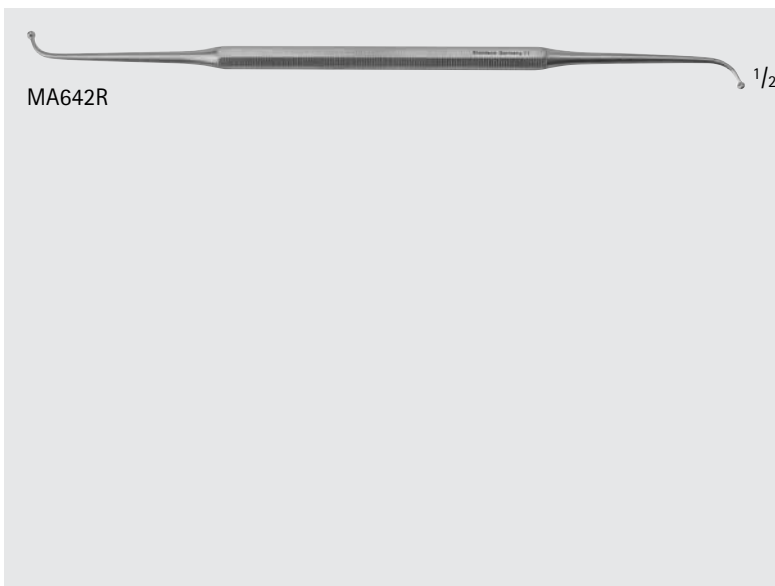

Maxillary Sinus Seeker Probe, Double Ended

Catalog Number	Tip	Tip Size (mm)	Length (in.)
MA642R	BALL	1.5 / 2	7 1/2

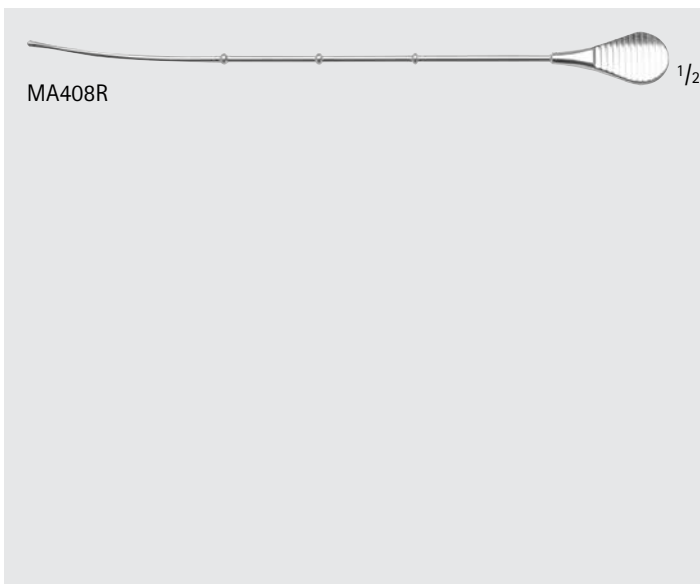

SKILLERN Sinus Probe

Catalog Number	Tip	Length (in.)
MA408R	MALLEABLE W/ BEADS AT 50, 70, AND 90 MM	6 3/4



OL354R-OL356R

BALLENGER Swivel Knife, Bayonet

Catalog Number	Blade Size (mm)	Length (in.)
OL354R	4 x 3	8 1/4
OL355R	5 x 4	8 1/4
OL356R	6 x 5	8 1/4

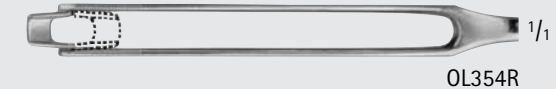

OL354R



OL355R



OL356R



MA205R-MA207R

BALLENGER Swivel Knife, Straight

Catalog Number	Blade Width (mm)	Length (in.)
MA205R	3	7 1/2
MB119R	3	7 3/4
MB118R	4	7 3/4
MA207R	5	7 1/2



MA205R-MA207R



MB119R-MB118R



MB119R



MB118R



OL109R

CONVERSE Septum Knife, Button End

Catalog Number	Blade	Length (in.)
OL109R	CVD	6



OL109R



OL113R

COTTLE Septum Knife, Round End

Catalog Number	Blade	Length (in.)
OL113R	STR	5 1/2



OL113R

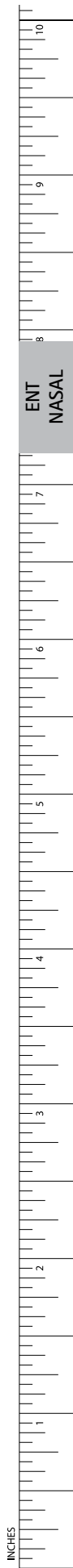

ENT-NASAL

Knives



OL120R



OL120R



MA212R



MA212R



MA211R

FREER Septum Knife

Catalog Number	Blade Shape	Blade Size (mm)	Length (in.)
OL120R	"D" SHAPED	3	6
MA212R	"D" SHAPED	3	6 1/8
MA211R	ANG	5 x 8	7



OL111R



OL111R



OL107R



OL107R

JOSEPH Knife, Button End

Catalog Number	Tip	Length (in.)
OL111R	STR	5 1/2
OL107R	CVD	6 7/8



OL102R-OL104R



OL102R



OL104R

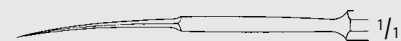

OL104R

JOSEPH Knife, Double Edge

Catalog Number	Blade	Blade Size (mm)	Length (in.)
OL102R	STR	5 x 23	5 3/4
OL104R	CVD	5 x 23	5 3/4

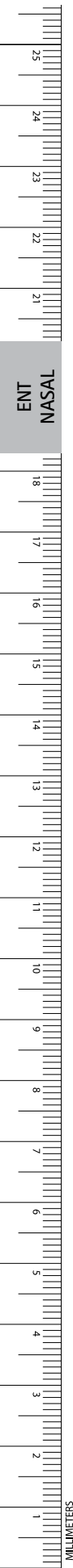



Suction Tube, Angled

Catalog Number	Tip	Tip Size (Gauge)	Length (in.)
MA010R	ANG	13	3



Nasal Suction Tube W/ Luer Hub, Tapered

Catalog Number	Tip Size (mm)	Length (in.)
GF919R	5	7

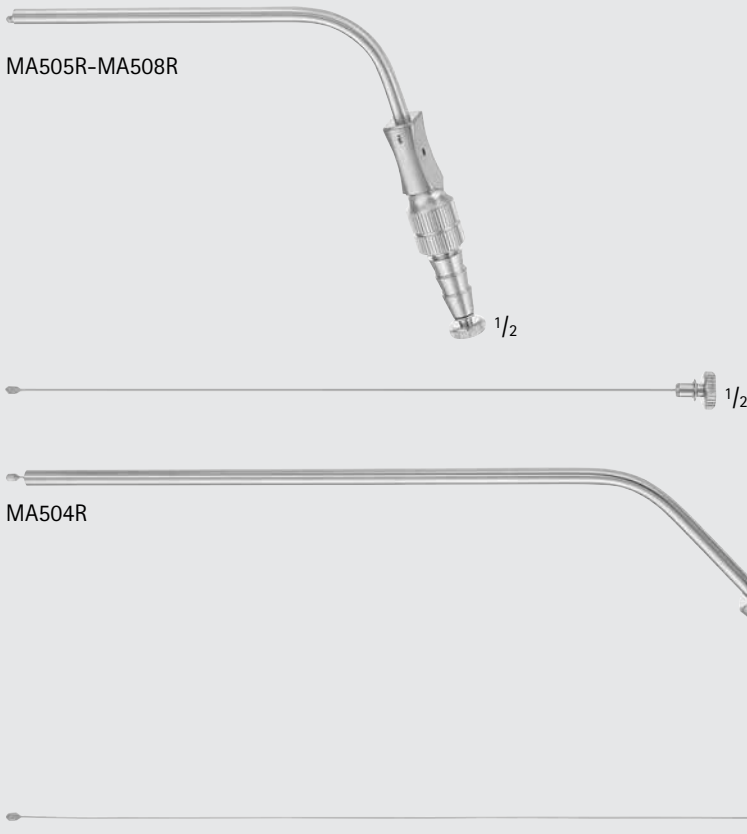

FERGUSON-FRAZIER Suction Tube

Catalog Number	Tip	Tip Size (FR)	Working Length (in.)	Length (in.)
MA505R	ANG	8	7 7/8	10 1/4
MA506R	ANG	10	7 7/8	10 1/4
MA508R	ANG	14	4	6 1/2
MA504R	ANG	14	5 7/8	8

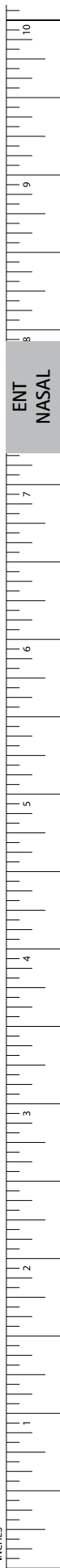

ENT-NASAL

Suction and Irrigation

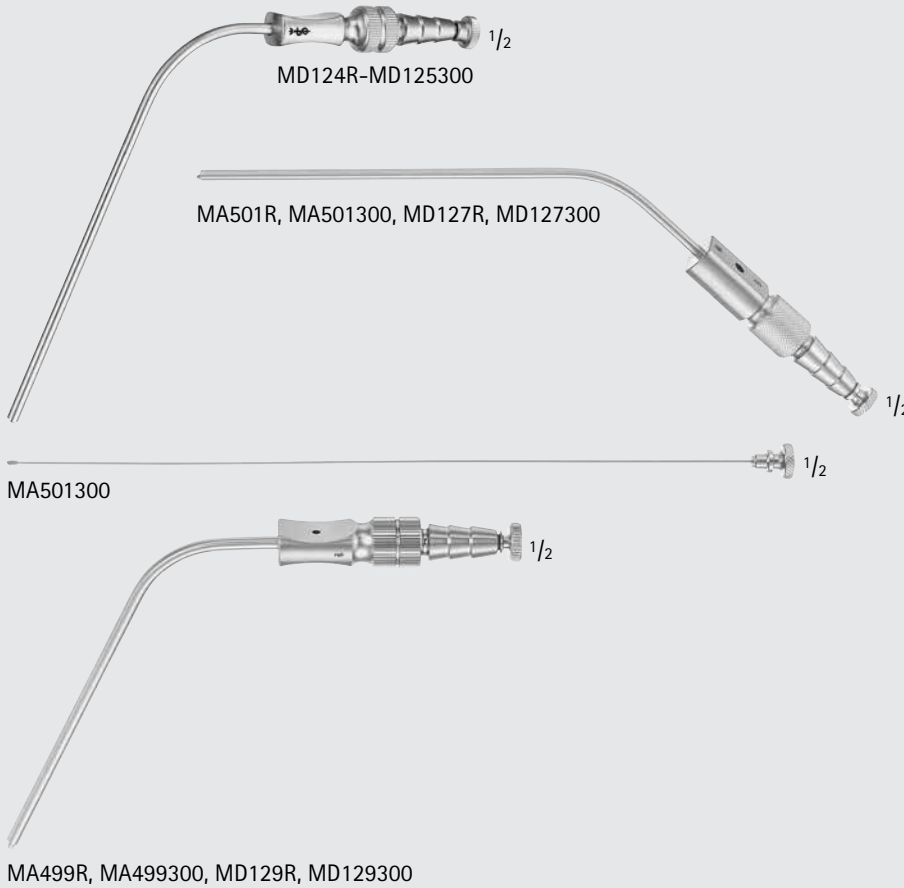

FRAZIER Suction Tube

Catalog Number	Tip Size (FR)	Description	Working Length (in.)
MD124R	7		4 1/4
MD124300	7	SUCTION STYLET W/ OLIVE TIP FOR MD124R	
MD125R	8		4 1/4
MD125300	8	SUCTION STYLET W/ OLIVE TIP FOR MD125R	
MA501R	9		4 1/4
MA501300		SUCTION STYLET W/ OLIVE TIP FOR MA501R	
MD127R	10		4 1/4
MD127300	10	SUCTION STYLET W/ OLIVE TIP FOR MD127R	
MA499R	11		4 1/4
MA499300	11	SUCTION STYLET W/ OLIVE TIP FOR MA499R	
MD129R	12		4 1/4
MD129300	12	SUCTION STYLET W/ OLIVE TIP FOR MD129R	

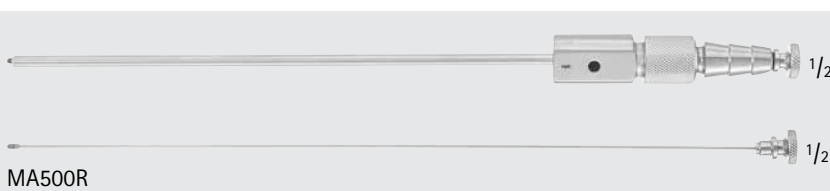

FRAZIER Suction Tube, Straight

Catalog Number	Tip	Working Length (in.)	Length (in.)
MA500R	STR	5 1/2	6 7/8



FRAZIER Suction Tube W/ Luer Hub

Catalog Number	Tip Size (FR)	Length (in.)
GF923R	9	7
GF925R	15	7

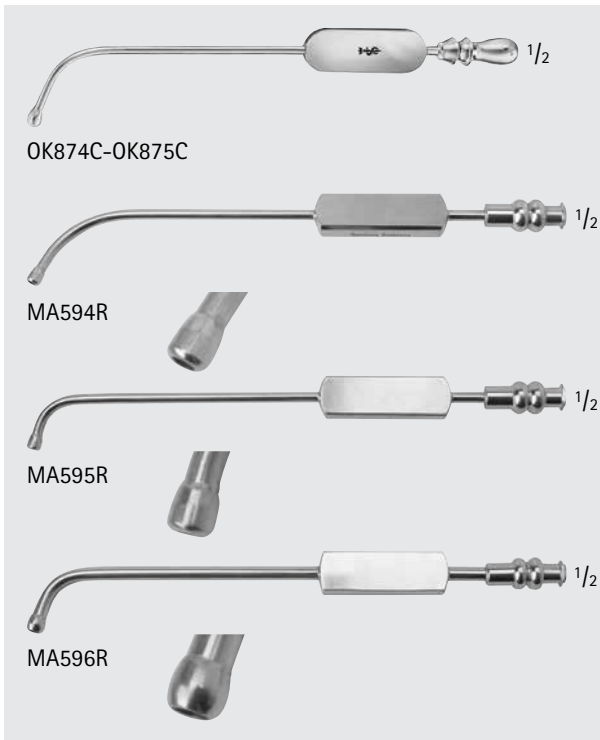

EICKEN Antrum Suction Tube, Bulbous

Catalog Number	Tip	Diameter (mm)	Length (in.)
OK874C	SMALL	2.5	5 1/8
OK875C	LARGE	3	5 1/8
MA594R	LONG CURVE	3	5 5/8
MA595R	SHORT CURVE	3	5 5/8
MA596R	SHORT CURVE	4	5 5/8

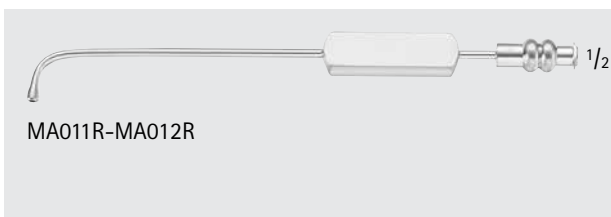

KILLIAN Antrum Cannula

Catalog Number	Tip Size	Tip Size (#)	Length (in.)
MA011R	SMALL	1	5
MA012R	LARGE	2	5

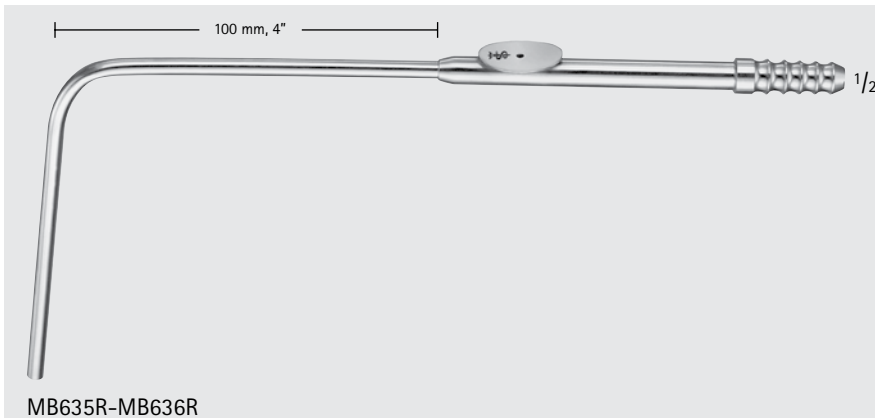

SACHS Suction Tube

Catalog Number	Tip Size	Length (in.)
MB635R	SMALL	8 1/2
MB636R	LARGE	8 1/2

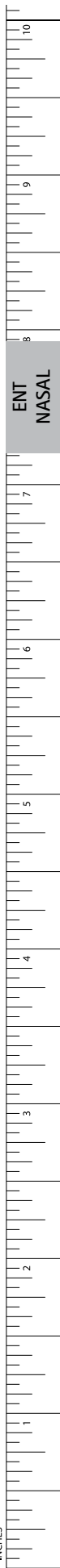

ENT-NASAL

Suction and Irrigation



GORNEY Suction Dissector, Elevator

Catalog Number	Tip Size (mm)	Length (in.)
OL168R	6-10	7
MA142R	3	8 1/2



MA142R

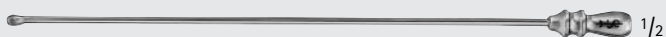

HAJEK Irrigating Cannula

Catalog Number	Diameter (mm)	Length (in.)
OK900	3.5	6 1/2

OK900



HOUSE Cutoff Adapter

Catalog Number	Tip	Tip Size (mm)
MA607R	TUBING END	4

MA607R

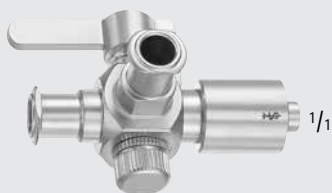

Stopcock Luer Adapter, Female to Male

Catalog Number	Description
MA716R	FEMALE TO MALE LUER LOCK W/ FEMALE RIGHT

MA716R



Luer Adapter

Catalog Number	Description
MA715R	MALE LUER LOCK-TO-HOSE

MA715R

ENT
NASAL

ENT-NASAL

Mallets, Hammers and Tamps

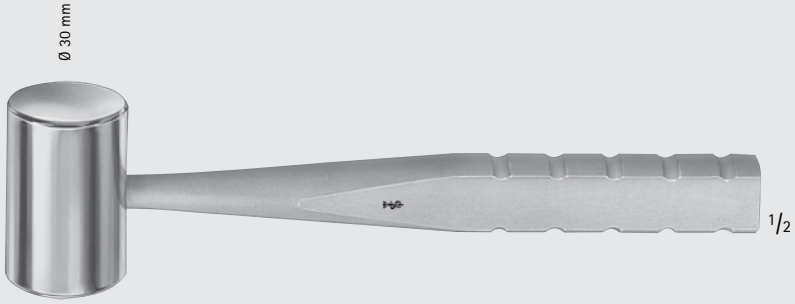

Ø 30 mm

FLO38R

1/2

COTTLE Mallet, Flat/Round, 235gr

Catalog Number	Diameter (mm)	Length (in.)
FLO38R	30	7 1/4



MB303R

1/2

CRANE Mallet

Catalog Number	Diameter (mm)	Length (in.)
MB303R	32	6 1/4



Ø 25 mm

DF114R

1/2

Mallet, 155gr

Catalog Number	Diameter (mm)	Length (in.)
DF114R	25	7 1/2

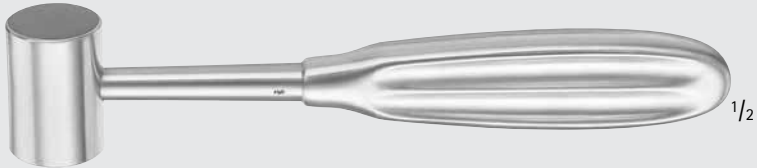

MA239R

1/2

Lead Mallet

Catalog Number	Diameter (mm)	Handle	Description	Length (in.)
MA239R	25	LARGE	LEAD FILLED	7 1/16



ENT-NASAL

Mallets, Hammers and Tamps

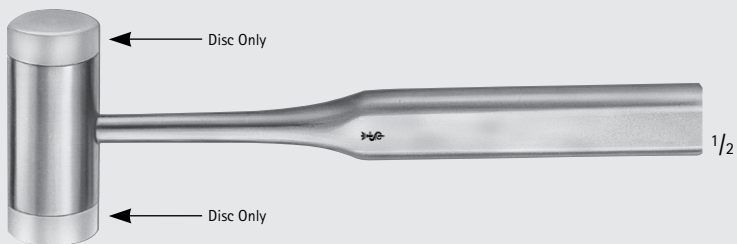

FL036R-FL037

Mallet W/ Removable Nylon Discs, 135gr

Catalog Number	Description	Diameter (mm)	Length (in.)
FL036R	COMPLETE	25	7 1/4
FL037	NYLON SPARE DISCS, F/FL036R, 2/SET	25	

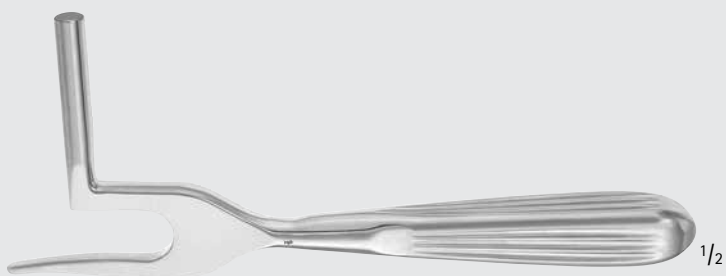

MA338R

QUISLING Intranasal Hammer

Catalog Number	Length (in.)
MA338R	6 3/4



FL093R-FL096R

Bone Tamp

Catalog Number	Diameter (mm)	Length (in.)
FL093R	3	6 1/4
FL094R	5	6 1/4
FL095R	7	6 1/4
FL096R	9	6 1/4



FL093R



FL094R



FL095R



FL096R

ENT
NASAL



MA589R-MA593R



MA589R



MA588R



MA592R

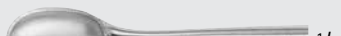

MA593R



FK651R-FK654R

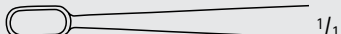

FK651R

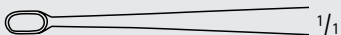

FK652R

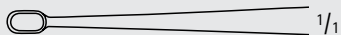

FK653R

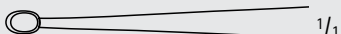

FK654R



MA591R



MA591R



MA590R



MA590R

Antrum Curette

Catalog Number	Tip	Tip Size (mm)	Length in.)
MA589R	OBLONG	-	7 1/2
MA588R	OVAL CUP	7 x 11	7 1/2
MA592R	OVAL CUP	8 x 11	7 1/2
MA593R	OVAL CUP	9 x 13	7 1/2
FK651R	OVAL CUP, ANG	9.5 x 4	7 1/2
FK652R	OVAL CUP, ANG	6 x 3	7 1/2
FK653R	55° CVD	6 x 3	7 1/2
FK654R	90° CVD	6 x 3	7 1/2
MA591R	BACKWARD CUTTING	7 x 10	7 1/2
MA590R	FORWARD CUTTING	7 x 10	7 1/2



ENT-NASAL

Curettes



FK817R



FK817R

BARTH Bone Curette, Double Ended

Catalog Number	Tip Size (mm)	Length (in.)
FK817R	2.3 x 6.0 / 2.7 x 7.0	7



OK811R-OK816R

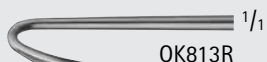

COAKLEY Antrum Curette

Catalog Number	Blade	Size (#)	Length (in.)
MB799R	-	SET OF 6 INCLUDES OK811R- OK816R	-
OK811R	SLIGHT ANG	1	6 3/4
OK812R	45°	2	6 3/4
OK813R	REV ANG	3	6 3/4
OK814R	SLIGHT ANG	4	6 3/4
OK815R	45°	5	6 3/4
OK816R	45°	6	6 3/4

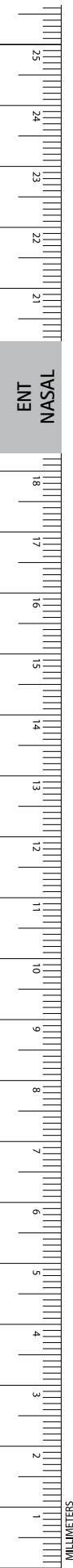



FK813R

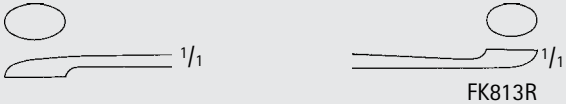

JACOBSON Bone Curette, Double Ended

Catalog Number	Tip Size (mm)	Length (in.)
FK813R	4.3 x 6.5 / 4.5 x 8.5	5 1/2



FK803R

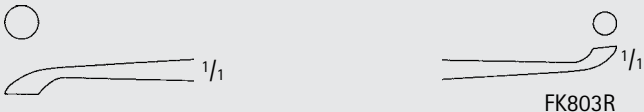

JANSEN Bone Curette, Double Ended

Catalog Number	Diameter (mm)	Length (in.)
FK803R	4.3 / 3.6	6 1/4



FK840R

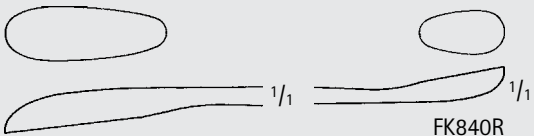

VOLKMANN Bone Curette, Double Ended

Catalog Number	Tip Size (mm)	Length (in.)
FK840R	7.5 x 21.0 / 6.0 x 11.0	5 1/8
FK842R	7.5 x 21.0 / 6.0 x 11.0	6 3/4



FK842R

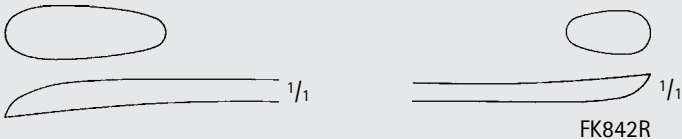

FK814R

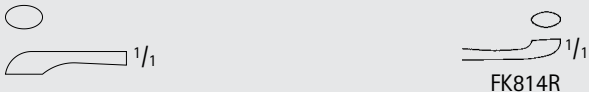

WILLIGER Bone Curette, Double Ended

Catalog Number	Tip Size (mm)	Length (in.)
FK814R	2.0 x 3.5 / 3.0 x 4.5	5 3/4

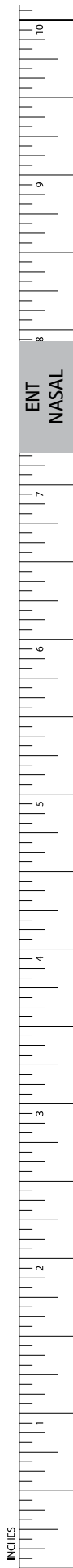

ENT-NASAL

Curettes

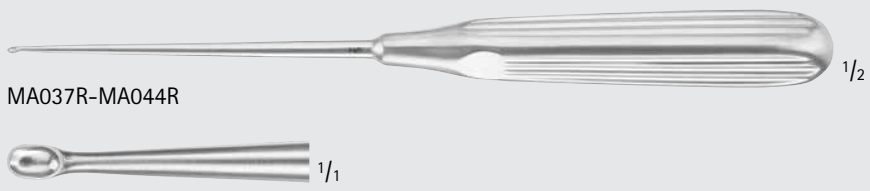

LEMPERT Bone Curette

Catalog Number	Size (#)	Length (in.)
MA037R	000000	8
MA038R	00000	8
MA039R	0000	8
MA044R	2	8

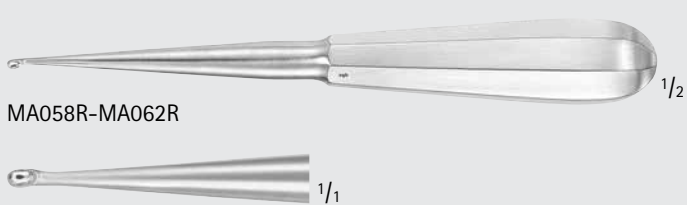
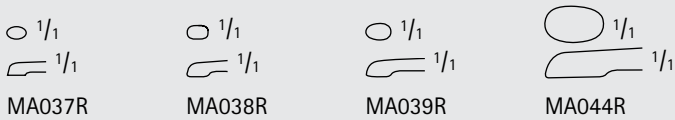

SPRATT Mastoid Curettes

Catalog Number	Tip Size (mm)	Size (#)	Length (in.)
MA058R	2.5 x 4	00	6 1/2
MA059R	3 x 5	0	6 1/2
MA060R	3.5 x 6	1	6 1/2
MA061R	4.5 x 8	3	6 1/2
MA062R	5.5 x 9	4	6 1/2

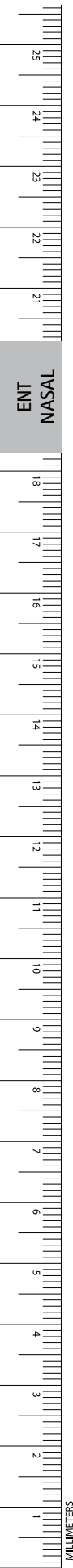
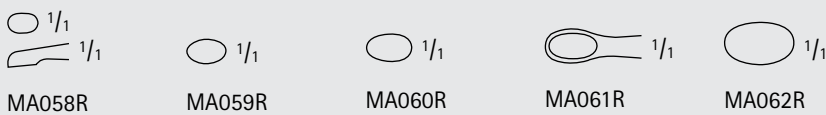

ALEXANDER Bone Rongeur

Catalog Number	Jaw Size (mm)	Jaw	Length (in.)
FO440R	3.2 x 27	ANG	5 1/2



FO440R



FO440R

BANE-HARTMANN Bone Rongeur

Catalog Number	Jaw Size (mm)	Jaw	Length (in.)
FO457R	4.0 x 32	CVD	6 7/8

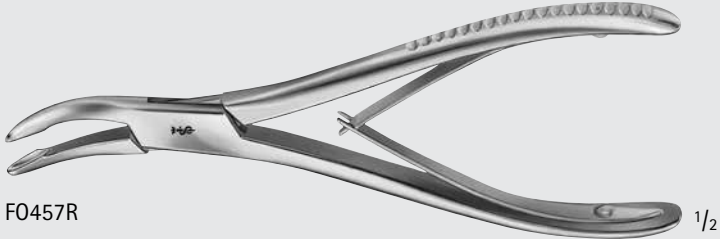

FO457R



FO457R

BEYER Bone Rongeur

Catalog Number	Jaw Size (mm)	Jaw	Handle	Length (in.)
FO453R	3.2 x 32	CVD	Single Action	7
FO514R	4.0 x 30	CVD	Double Action	7

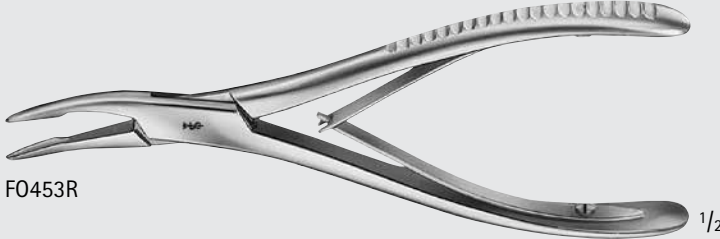

FO453R



FO453R



FO514R

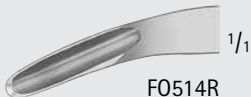

FO514R

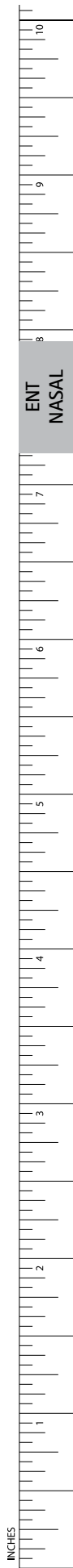

ENT-NASAL

Rongeurs

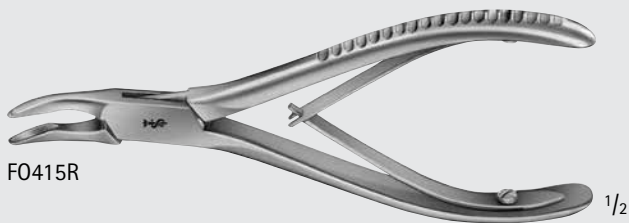

FO415R

1/2



FO415R

1/1

BLUMENTHAL Bone Rongeur

Catalog Number	Jaw Size (mm)	Jaw	Length (in.)
FO415R	3.5 x 25	CVD	6 1/8

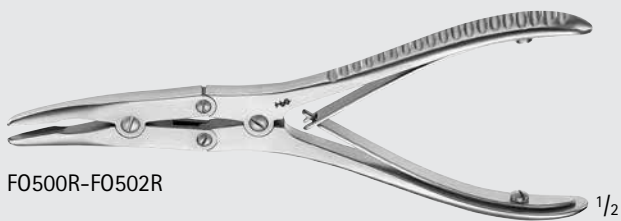

FO500R-FO502R

1/2



FO500R

1/1

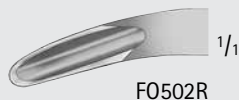

FO502R

1/1

BOEHLER Bone Rongeur, Double Action

Catalog Number	Jaw Size (mm)	Jaw	Jaw End	Length (in.)
FO500R	3.0 x 27	CVD	NARR	6 1/8
FO502R	3.5 x 30	CVD	WIDE	6 1/8

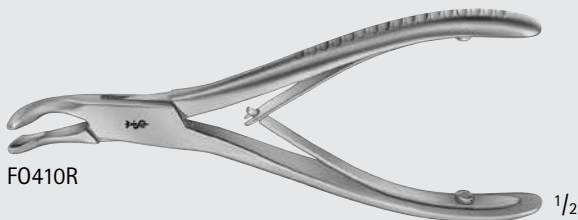

FO410R

1/2



FO410R

1/1

Bone Rongeur

Catalog Number	Jaw Size (mm)	Jaw	Length (in.)
FO410R	3.8 x 19	CVD	5 1/2

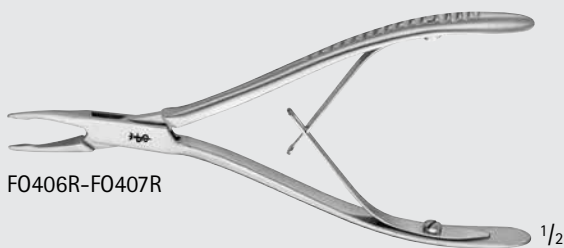

FO406R-FO407R

1/2



FO406R

1/1



FO407R

1/1

FRIEDMANN Micro Rongeur

Catalog Number	Jaw Size (mm)	Jaw	Length (in.)
FO406R	1.3 x 19	STR	5 1/2
FO407R	1.3 x 20	CVD	5 1/2

ENT
NASAL

MILLIMETERS



FO430R-FO432R

1/2



FO430R

1/1



FO432R

1/1



FO442R

1/2

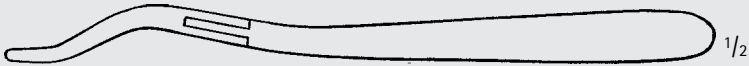

1/2



FO442R

1/1

JANSEN Bone Rongeur

Catalog Number	Jaw Size (mm)	Jaw	Length (in.)
FO430R	4.2 x 35	STR	6 7/8
FO432R	4.5 x 30	CVD	6 7/8
FO442R	3.8 x 37	ANG	7 1/2

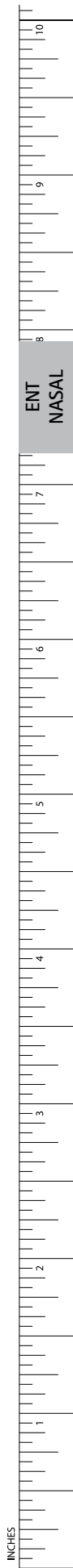

INCHES

ENT-NASAL

Rongeurs

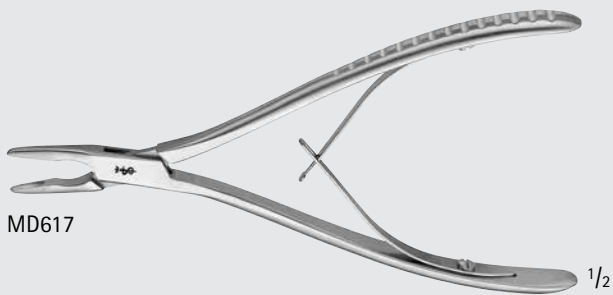

MD617

1/2



MD617

1/1

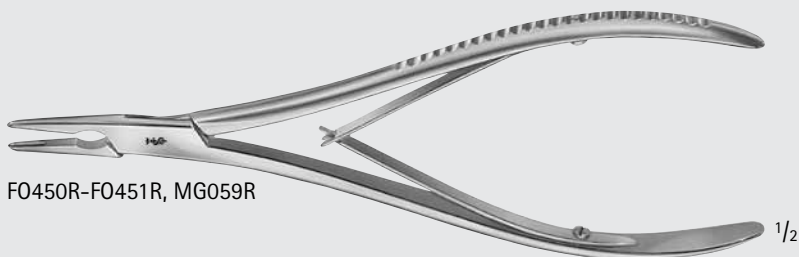

FO450R-FO451R, MG059R

1/2



FO450R

1/1



MG059R

1/1



FO451R

1/1

LEMPERT Bone Rongeur

Catalog Number	Jaw Size (mm)	Jaw	Length (in.)
MD617	2.0 x 23	DEL, STR	6 1/2
FO450R	2.2 x 27	STR	7 7/8
MG059R	2.5 x 30	CVD	6 1/4
FO451R	2.2 x 27	CVD	7 7/8

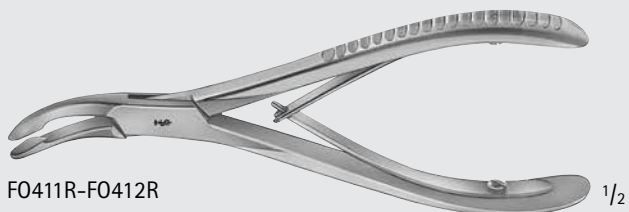

FO411R-FO412R

1/2



FO411R

1/1

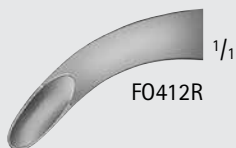

FO412R

1/1

LUER Bone Rongeur

Catalog Number	Jaw Size (mm)	Jaw	Length (in.)
FO411R	4.2 x 20	CVD	6
FO412R	4.2 x 26	STRONG CVD	6 1/8

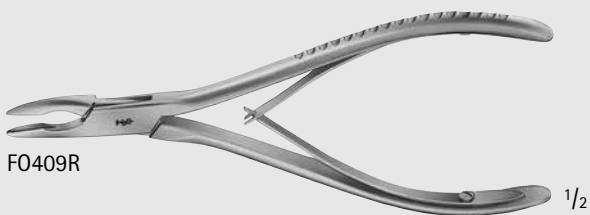

FO409R

1/2

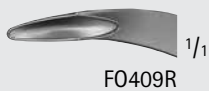

FO409R

1/1

LUER-FRIEDMANN Bone Rongeur

Catalog Number	Jaw Size (mm)	Jaw	Length (in.)
FO409R	2.2 x 22	CVD	5 3/4

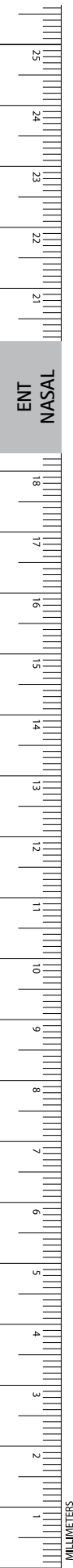

ENT
NASAL

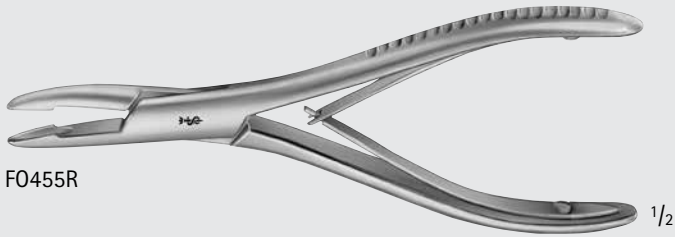

FO455R

1/2



1/1

FO455R

MEAD Bone Rongeur

Catalog Number	Jaw Size (mm)	Jaw	Length (in.)
FO455R	3.5 x 30	CVD	6 1/2



FO515R

1/2



1/1

FO515R

ZAUFAL-JANSEN Bone Rongeur, Double Action

Catalog Number	Jaw Size (mm)	Jaw	Length (in.)
FO515R	4.5 x 29	CVD	7

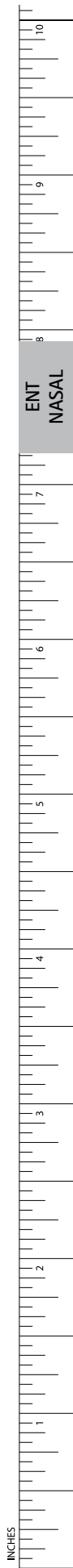

INCHES

ENT-NASAL

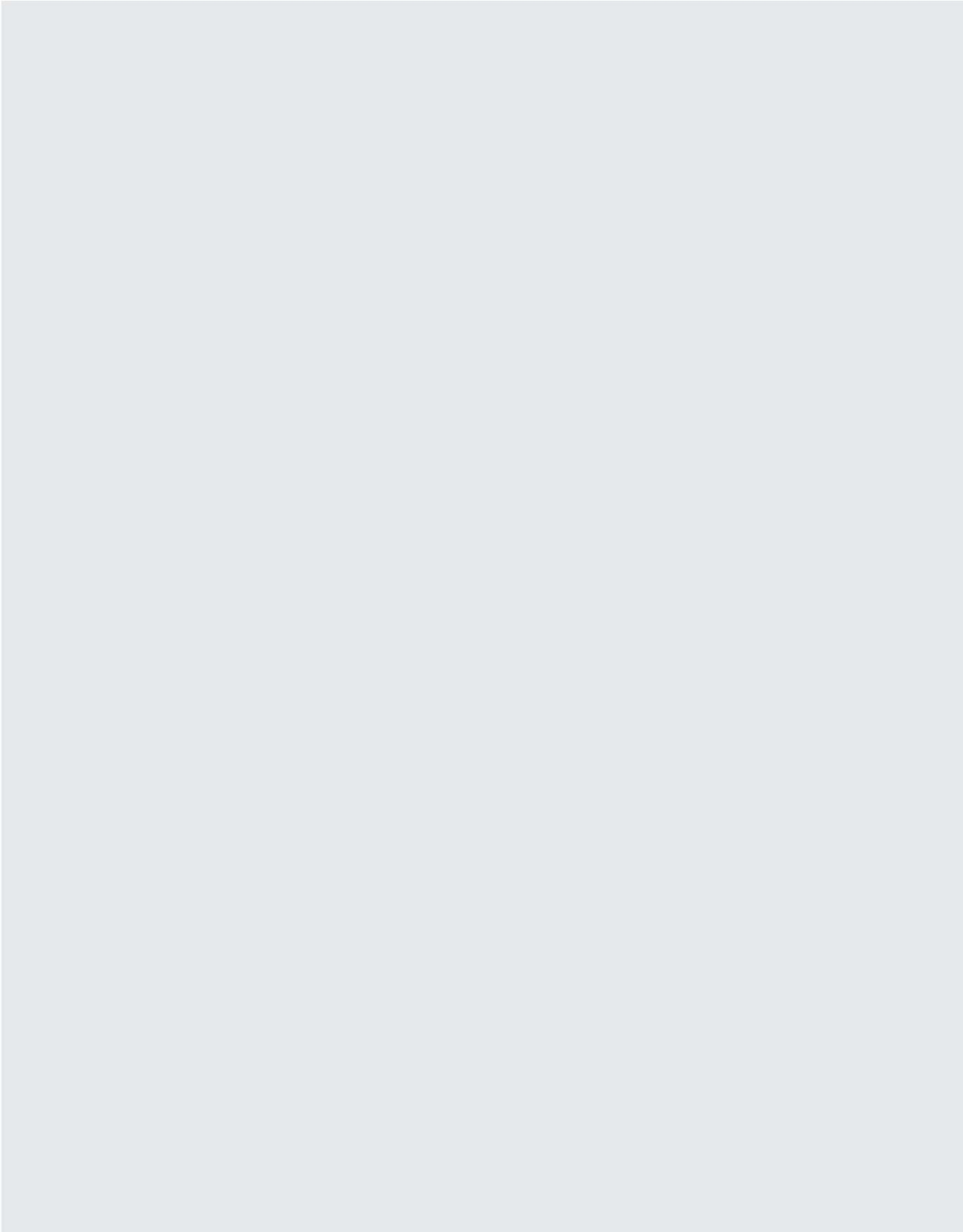
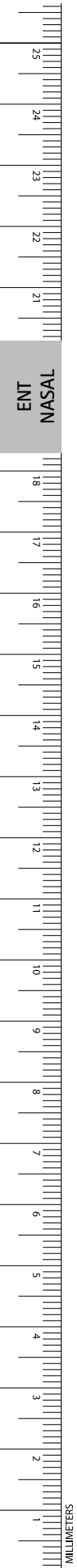



ENT-ORAL

Scissors	706 - 708
Needles	709
Forceps	709 - 712
Clamps	713 - 719
Tracheal Dilators / Hooks / Retractors	720 - 721
Retractors	722 - 724
Tonsil Dissectors	725
Adenotomes, Tonsil Snares and Wires	726 - 728
Mouth Gags	729 - 737
Tonsil Knives	738
Suction Tubes	739
Adenoid Curettes	740 - 742
Syringes	743
Laryngeal Mirrors	744
Amalgam Carriers	745

ENT-ORAL

Oral Scissors

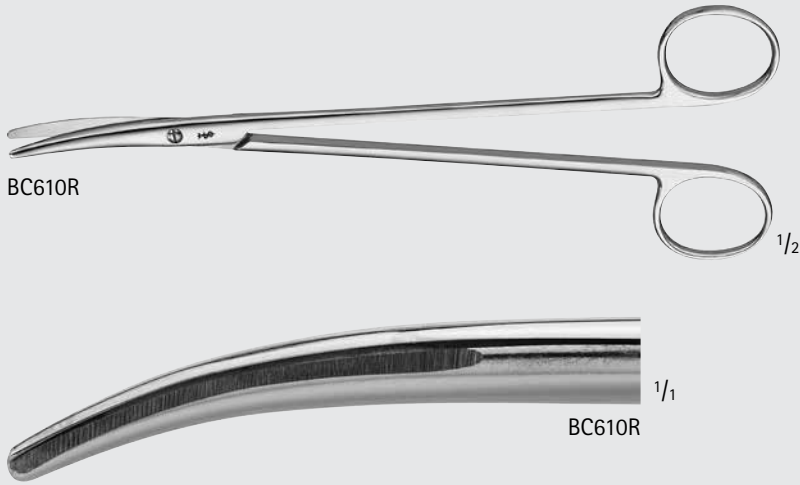

LILLIE Dissecting Scissors

Catalog Number	Tip	Blade	Length (in.)
BC610R	B/B	CVD	7 7/8

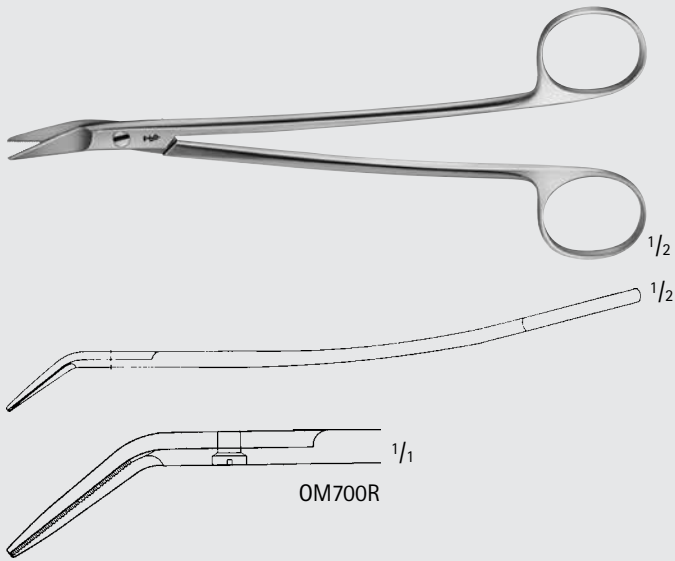

DEAN Tonsil Scissors

Catalog Number	Tip	Blade	Length (in.)
OM700R	B/B	ANG-SERR	6 3/4

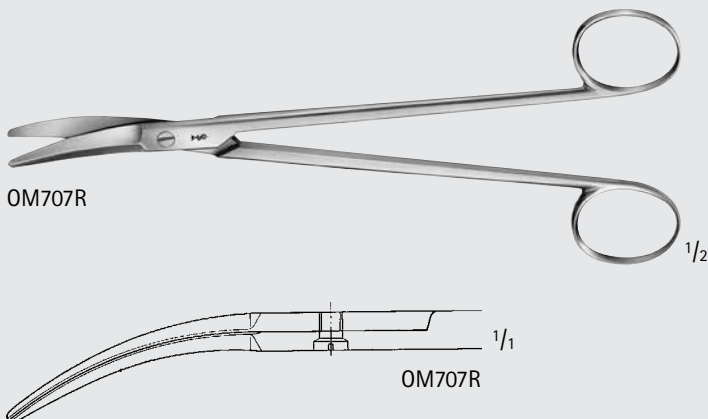

BOETTCHER Tonsil Scissors

Catalog Number	Tip	Blade	Length (in.)
OM707R	B/B	CVD	7

ENT
ORAL

MILLIMETERS

BROPHY Gum Scissors

Catalog Number	Tip	Blade	Length (in.)
MA445R	S/S	CVD	5 1/2

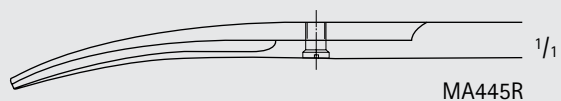
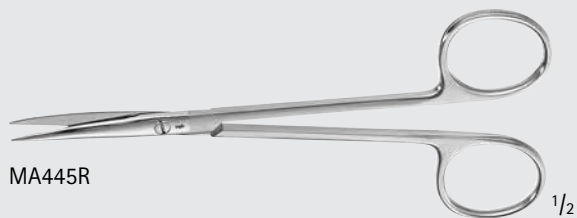

DUROTIP™ Tungsten Carbide Scissors

- Excellent cutting accuracy
- Long working life
- Gold-plated rings

DUROTIP TC Gum Scissors, Delicate

Catalog Number	Tip	Blade	Length (in.)
DO208R	S/S	STR	4 3/4
DO209R	S/S	CVD	4 3/4

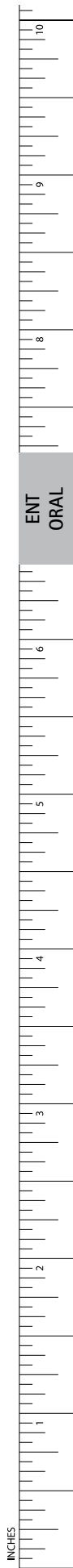
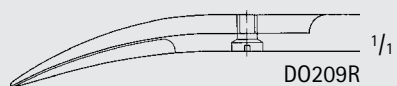
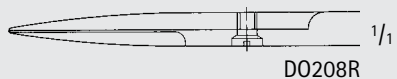
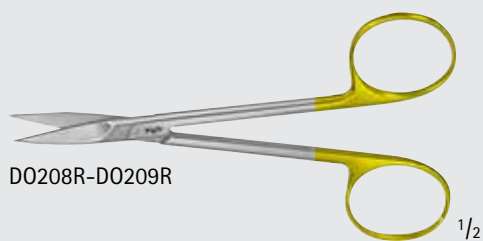

INCHES

ENT-ORAL

Laryngeal Scissors

Micro Laryngeal Scissors, W/ Flush Port

Catalog Number	Tip	Blade	Working Length (in.)
OP310R	S/S	STR	9 3/4
OP311R	S/S	CVD-LEFT	9 3/4
OP312R	S/S	CVD-RIGHT	9 3/4
OP313R	S/S	ANG-UP	9 3/4

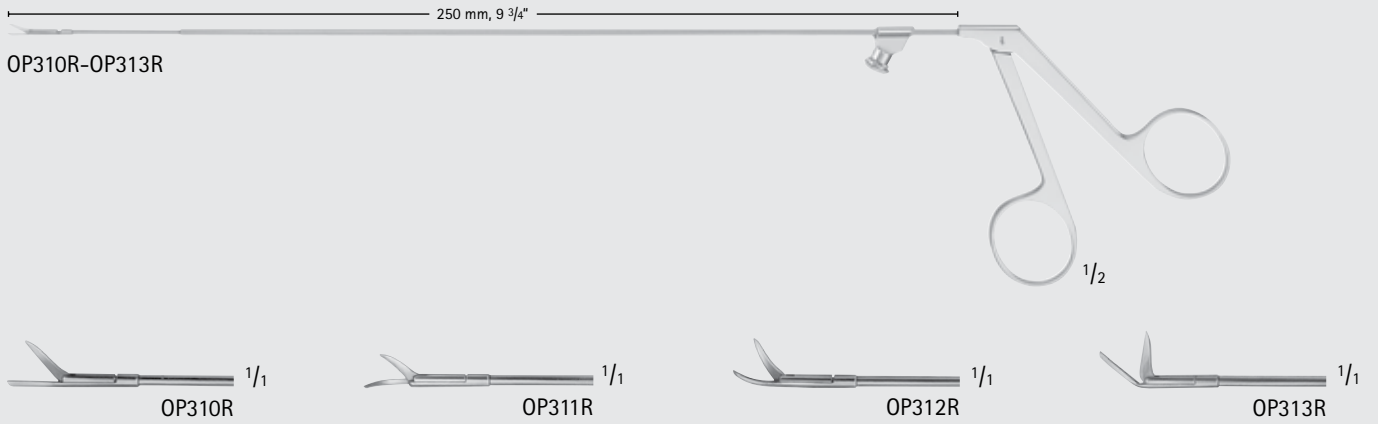

KLEINSASSER Micro Scissors

Catalog Number	Tip	Blade	Blade Size (mm)	Working Length (in.)
MA460R	B/B	STR	4	14

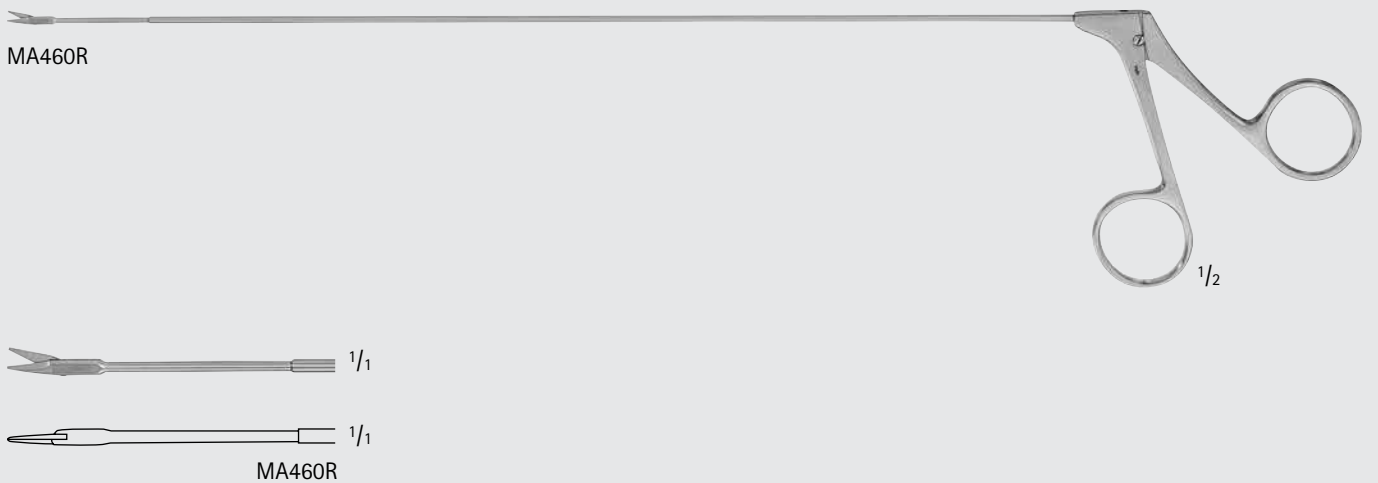

ENT
ORAL

MILLIMETERS

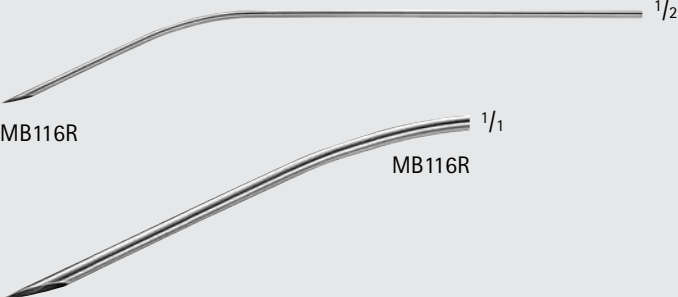

MB116R $\frac{1}{2}$

MB116R $\frac{1}{1}$

DINGMAN Wire Passing Needle

Catalog Number	Tip	Length (in.)
MB116R	CVD	6 3/4

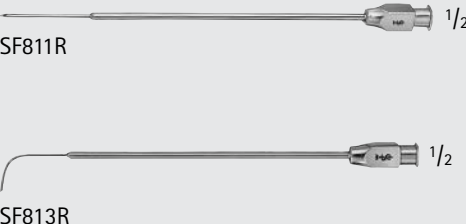

SF811R $\frac{1}{2}$

SF813R $\frac{1}{2}$

Tonsil Needle, 23 Gauge

Catalog Number	Tip	Tip Size (mm)	Length (in.)
SF811R	STR	DIAM. 0.8	3
SF813R	CVD	DIAM. 0.8	3

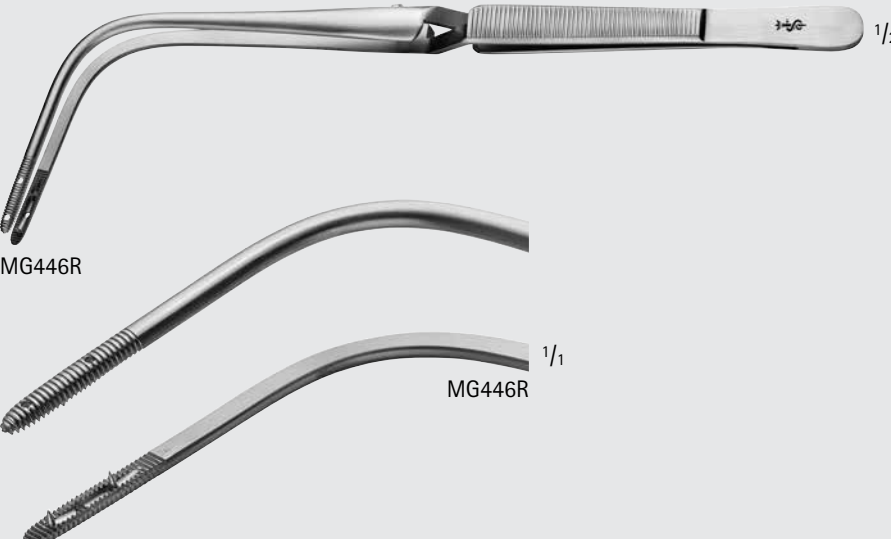

MG446R $\frac{1}{2}$

MG446R $\frac{1}{1}$

JACKSON Laryngeal Self-Closing Dressing Forceps

Catalog Number	Tip	Teeth	Length (in.)
MG446R	SERR	1 x 2	9



ENT
ORAL

INCHES

ENT-ORAL

Forceps

Laryngeal Forceps, W/ Flush Port

Catalog Number	Jaw	Working Length (in.)
OP300R	STR	9 3/4
OP301R	CVD-LEFT	9 3/4
OP302R	CVD-RIGHT	9 3/4

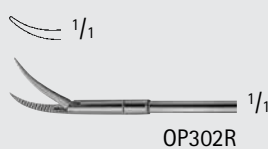
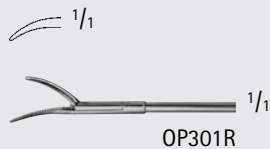
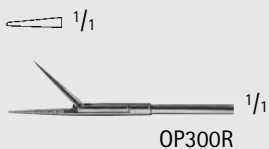
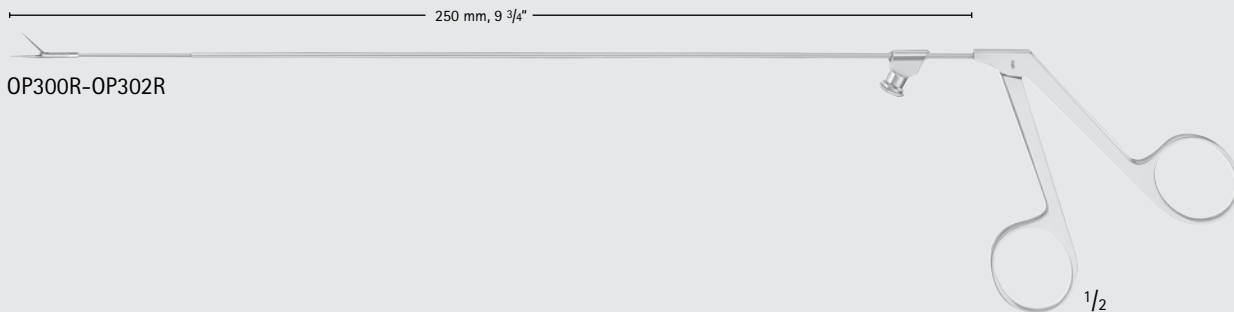

Micro Laryngeal Cup Forceps, W/ Flush Port

Catalog Number	Cup Size (mm)	Jaw	Working Length (in.)
OP304R	2	STR	9 3/4
OP305R	2	ANG-LEFT	9 3/4
OP306R	2	ANG-RIGHT	9 3/4
OP307R	2	ANG-UP	9 3/4

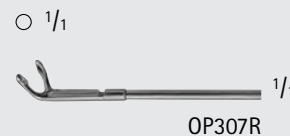
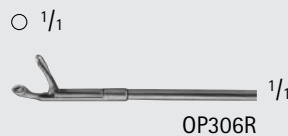
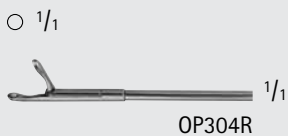
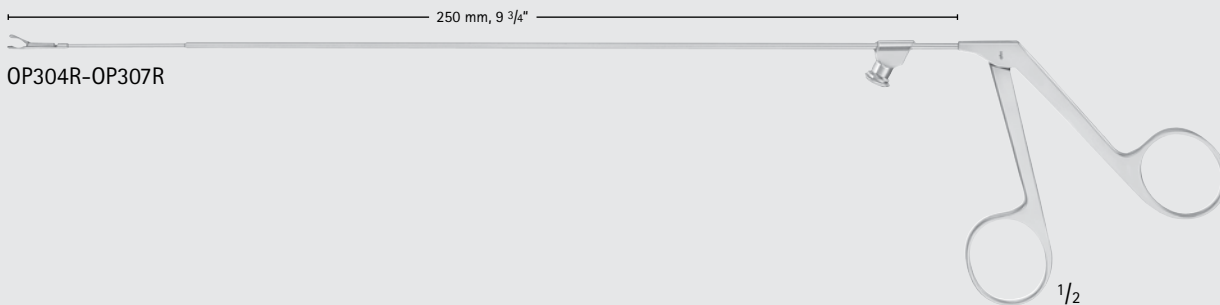

ENT
ORAL

MILLIMETERS

Alligator Grasping Forceps

Catalog Number	Tip	Tip Size (mm)	Working Length (in.)	Length (in.)
MA663R	SERR	8.8 x 4	11	13 3/4

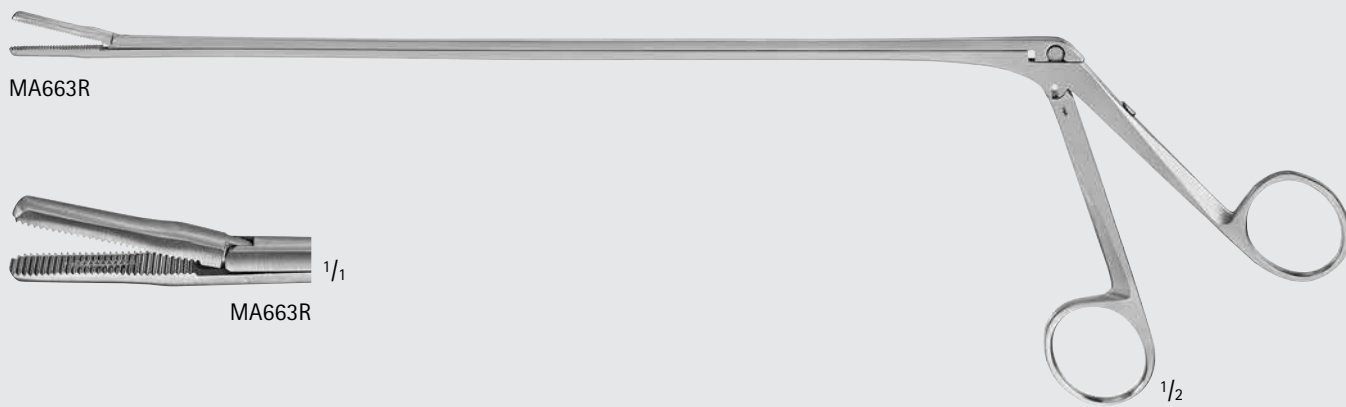

MA663R

MA663R

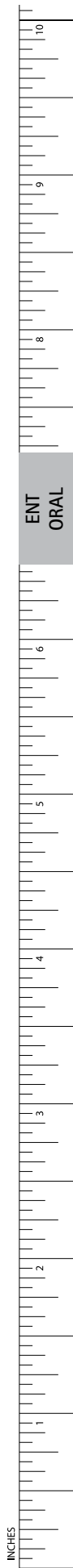

INCHES

ENT-ORAL

Forceps

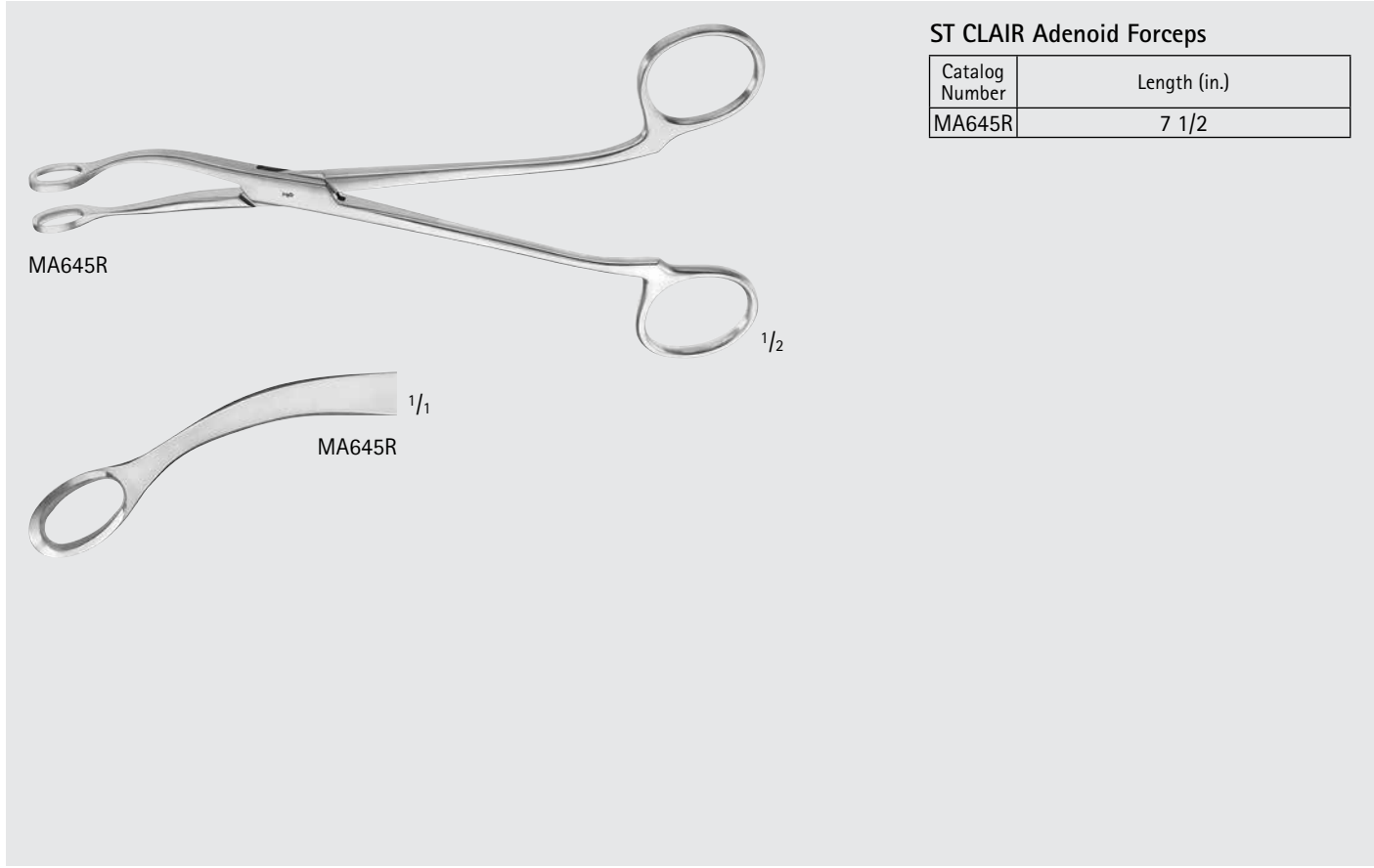
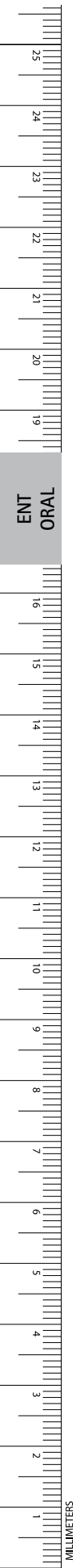

ST CLAIR Adenoid Forceps

Catalog Number	Length (in.)
MA645R	7 1/2

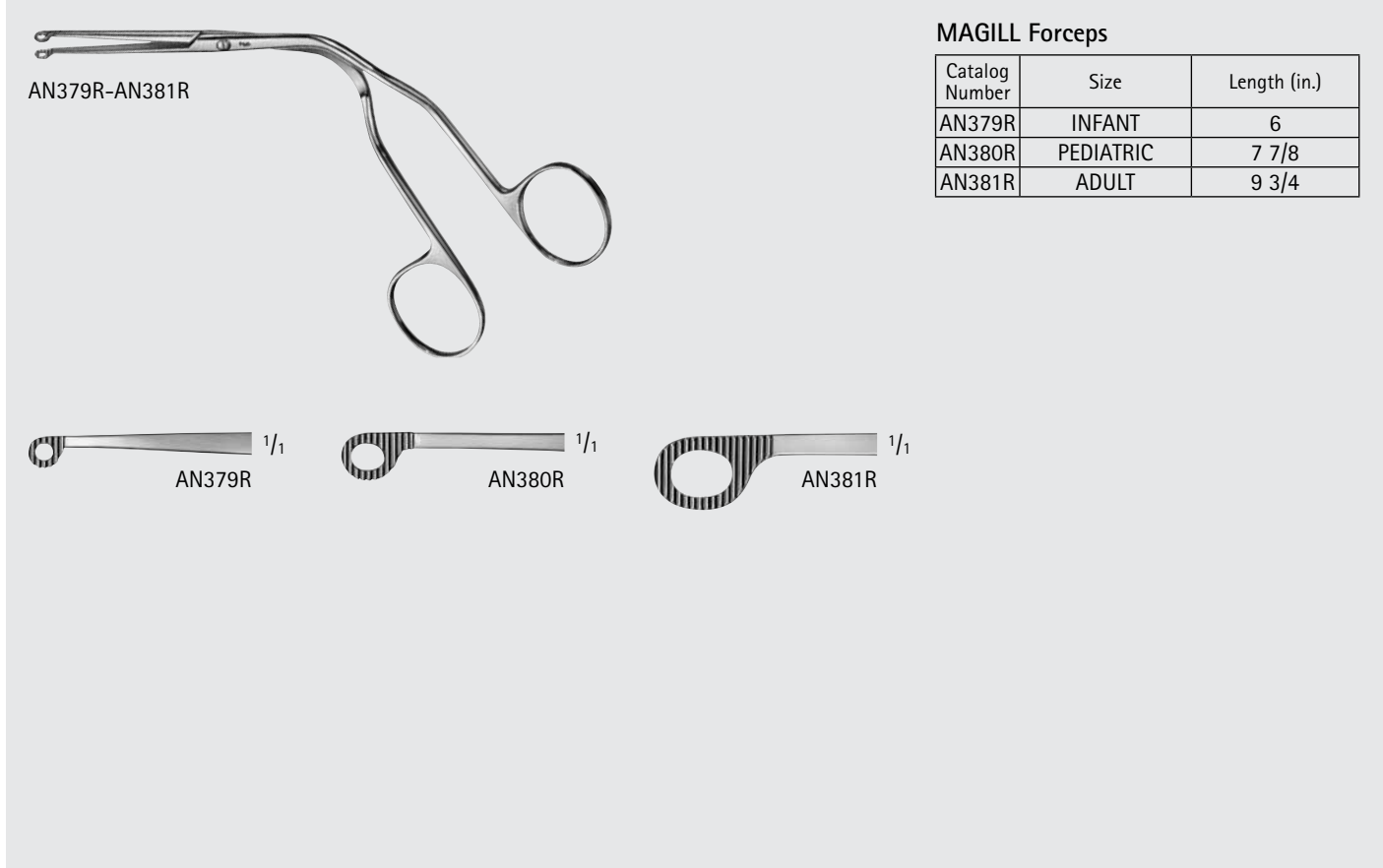

MAGILL Forceps

Catalog Number	Size	Length (in.)
AN379R	INFANT	6
AN380R	PEDIATRIC	7 7/8
AN381R	ADULT	9 3/4

SCHNIDT Tonsil Clamp

Catalog Number	Ring Handle	Jaw	Length (in.)
MA172R	OPEN RING	STR	7 1/2
BH961R	OPEN-RING	SLIGHT-CVD	7 1/4
BH963R	OPEN-RING	CVD	7 1/4
BH957R	CLOSED-RING	SLIGHT-CVD	7 1/4
BH959R	CLOSED-RING	CVD	7 1/4

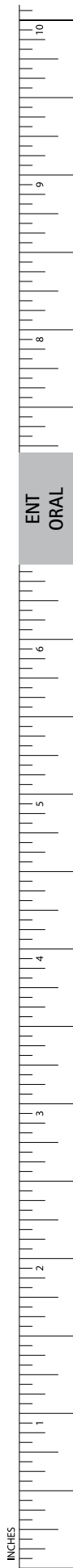
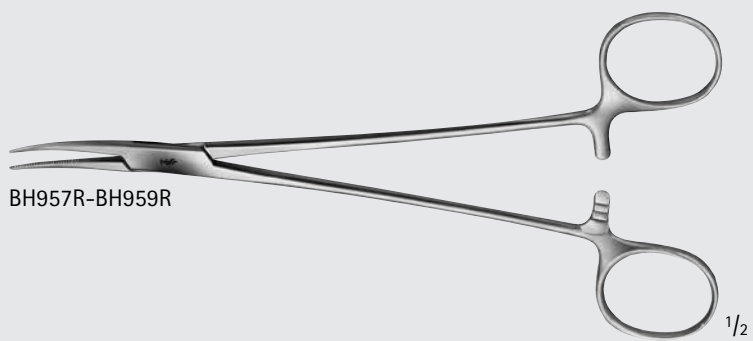
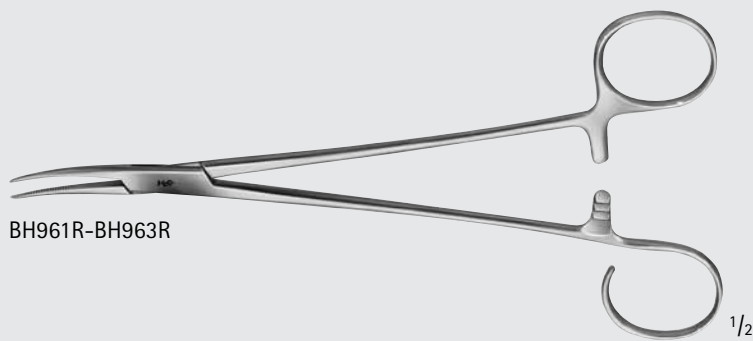
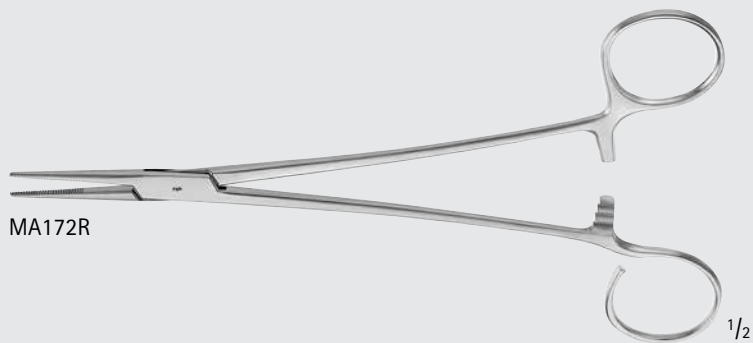

INCHES

ENT-ORAL

Clamps

Tonsil Clamp, X-long

Catalog Number	Jaw	Length (in.)
MB103R	CVD	14 1/2

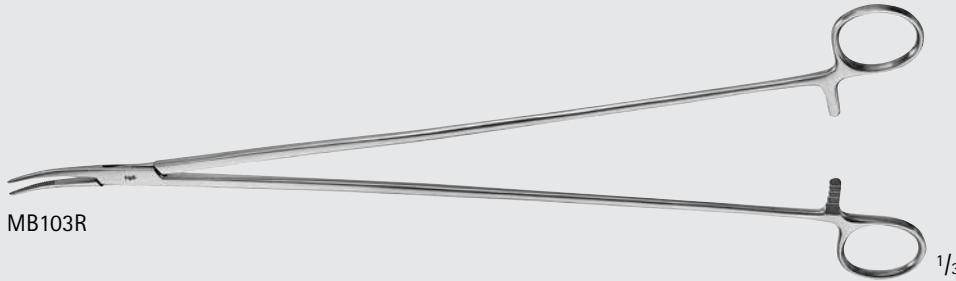

MB103R

1/3



MB103R

1/1

ADSON Tonsil Clamp, Delicate

Catalog Number	Jaw	Length (in.)
BH200R	STR	7 1/4
BH201R	CVD	7 1/4

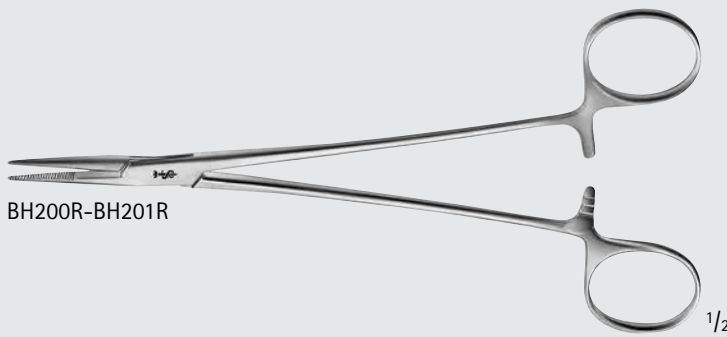

BH200R-BH201R

1/2



BH200R

1/1



BH201R

1/1

NISSEN Tonsil Clamp, Delicate

Catalog Number	Jaw	Length (in.)
BH199R	CVD	7 1/4

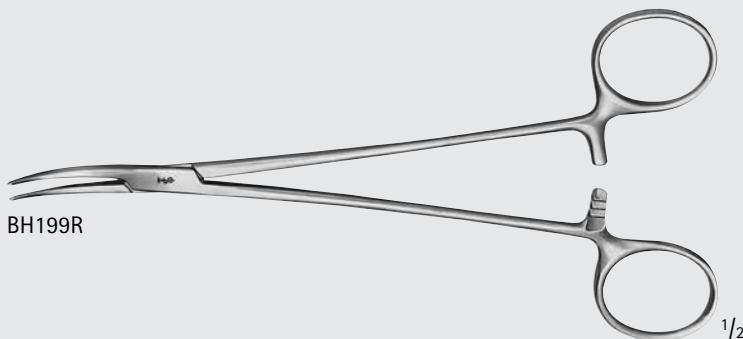

BH199R

1/2



BH199R

1/1

ENT
ORAL

MILLIMETERS

NEGUS Tonsil Clamp

Catalog Number	Jaw	Length (in.)
BH951R	HEAVY-CVD	7 1/2
BH952R	U-CVD	7 1/2

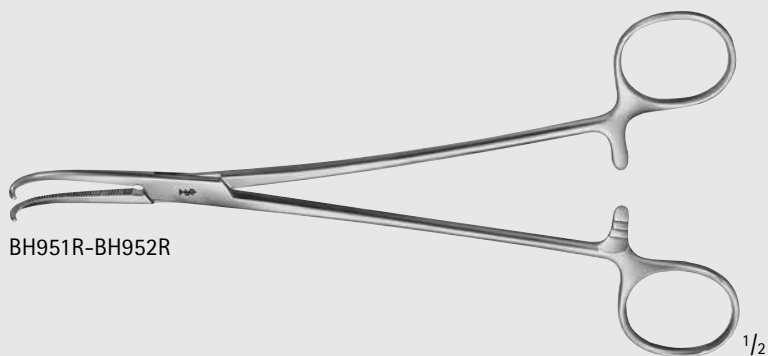

BH951R-BH952R

1/2

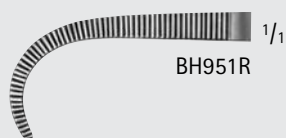

BH951R

1/1

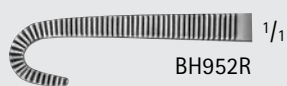

BH952R

1/1

MCHENRY Tonsil Artery and Sponge Holding Clamp

Catalog Number	Jaw	Length (in.)
MB533R	CVD	8

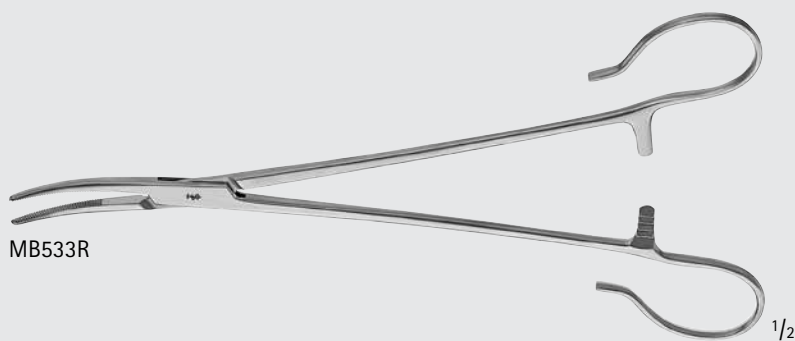

MB533R

1/2

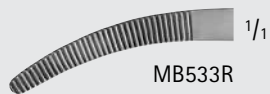

MB533R

1/1

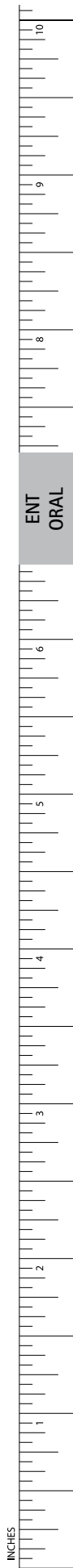

INCHES

ENT-ORAL

Clamps

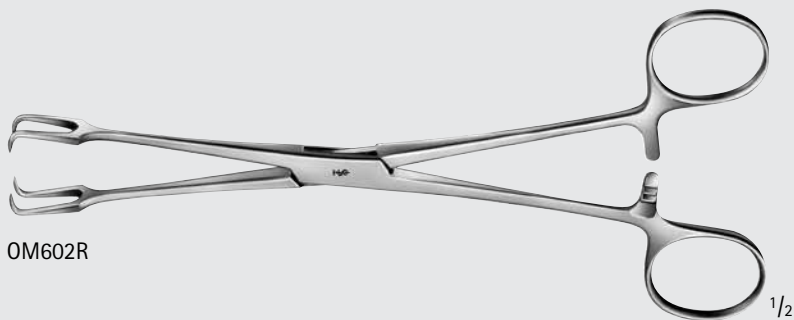

OM602R

1/2

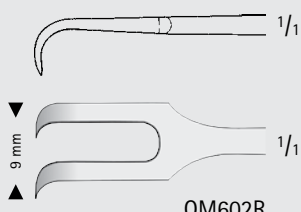

OM602R

MUSEUX Tonsil Clamp

Catalog Number	Tip	Length (in.)
OM602R	2 x 2	7 7/8



OM612R

1/2



OM612R

WHITE Tonsil Seizing Clamp

Catalog Number	Length (in.)
OM612R	7
OM613R	9 1/4

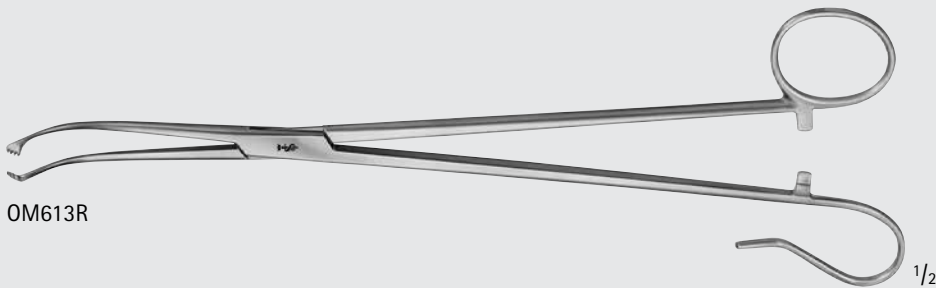

OM613R

1/2

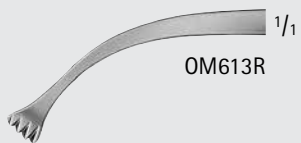

OM613R

ENT ORAL

ALLIS-COAKLEY Tonsil Clamp

Catalog Number	Jaw	Length (in.)
MA539R	STR	7 7/8
MA540R	STRONG CVD	7 5/8

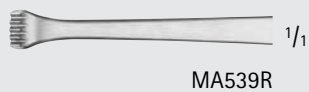
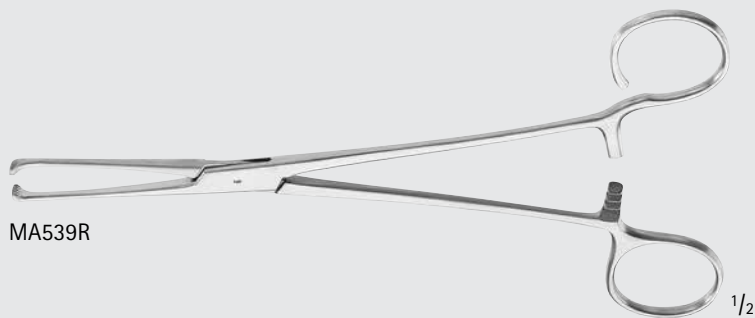

COLVER Tonsil Seizing Clamp

Catalog Number	Length (in.)
OM611R	7 7/8

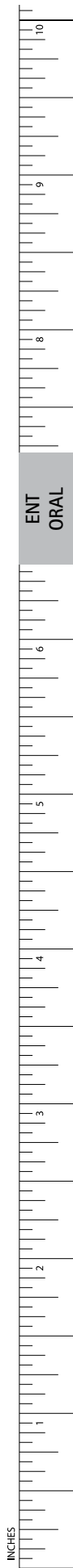

ENT-ORAL

Clamps

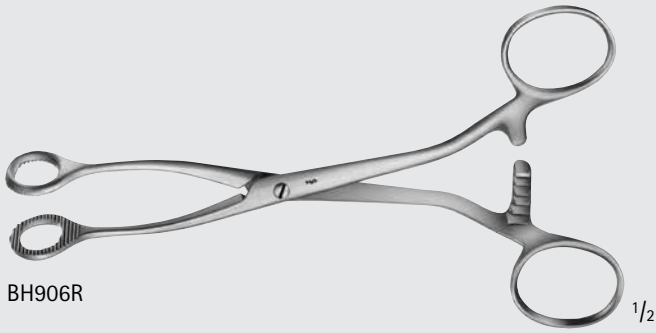

BH906R

1/2

COLLIN Tongue Clamp

Catalog Number	Jaw	Length (in.)
BH906R	OVAL	6 1/4

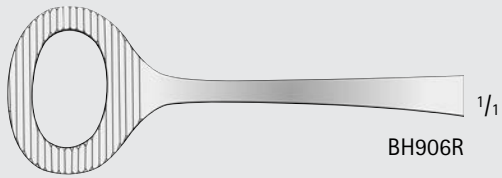

BH906R

1/1

ENT
ORAL

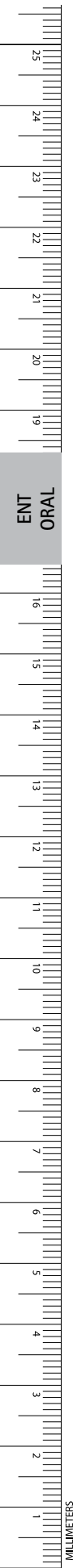

HEYWOOD-SMITH Tongue Clamp

Catalog Number	Tip	Length (in.)
AN710R	SERR	7 7/8
AN711R	SERR	8 1/4

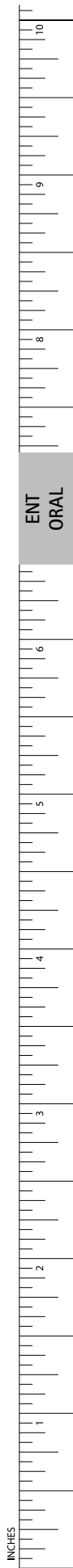
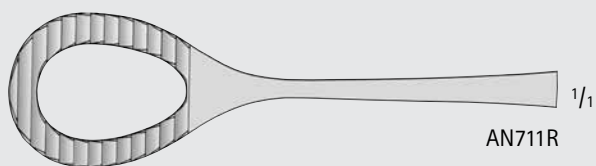
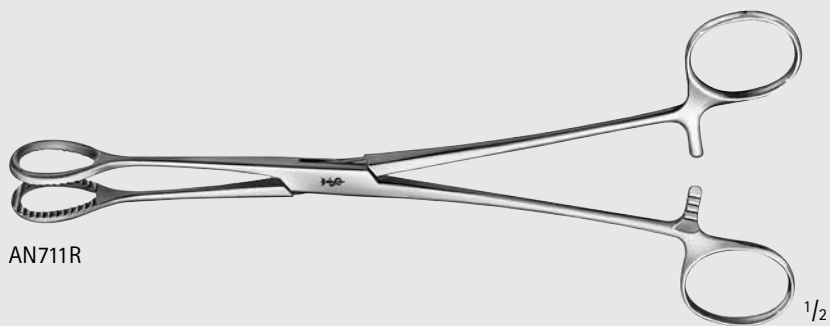
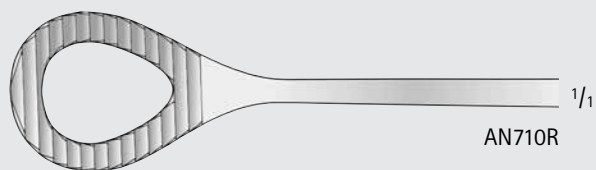
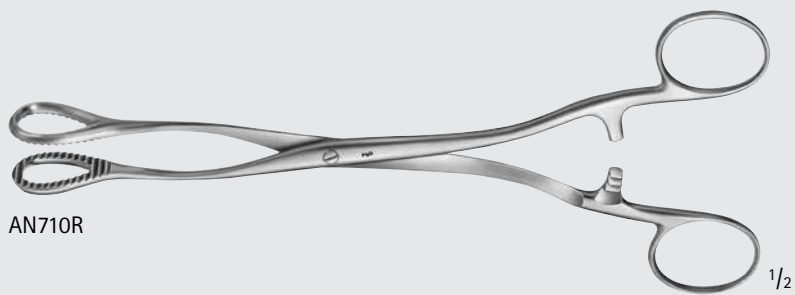

INCHES

ENT
ORAL

ENT-ORAL

Tracheal Dilators/Hooks/Retractors



FA025R

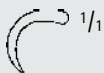

FA026R



BOSE Tracheal Hook

Catalog Number	Tip	Length (in.)
FA025R	CVD-LEFT	6 1/2
FA026R	CVD-RIGHT	6 1/2



BT103R-BT107R



BT103R



BT106R



BT107R

Tracheal Retractor

Catalog Number	Tip	Blade End	Length (in.)
BT103R	SHARP	1 PRONG	7
BT106R	BLUNT	1 PRONG	7
BT107R	BLUNT	2 PRONGS	7



MB230



1/1



1/1

MB230

JACKSON Tracheal Retractor

Catalog Number	Length (in.)
MB230	7



FA005R

1/2

TROUSSEAU Tracheal Dilator

Catalog Number	Length (in.)
FA005R	4 3/4

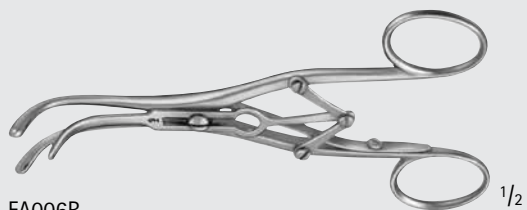

FA006R

1/2

LABORDE Tracheal Dilator

Catalog Number	Length (in.)
FA006R	5
FA007R	5 1/4

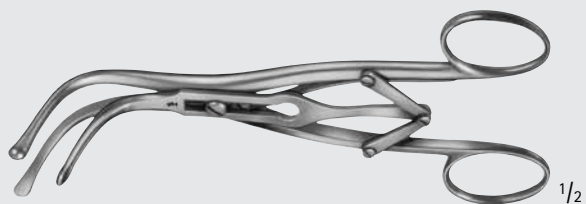

FA007R

1/2

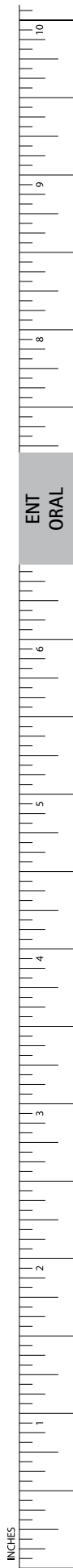

INCHES

ENT-ORAL

Retractors

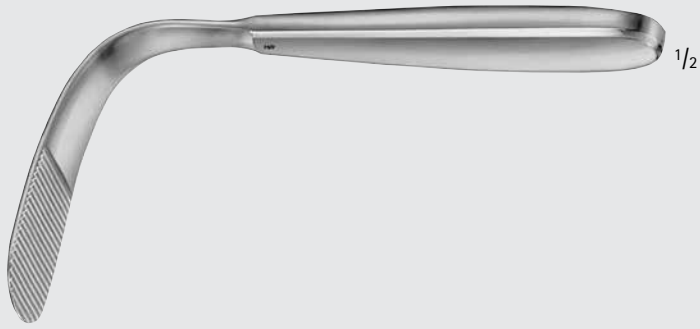

OM235R

TOBOLD Tongue Depressor

Catalog Number	Length (in.)
OM235R	6 1/4



OM236R-OM237R

WEDER Tongue Depressor

Catalog Number	Size	Length (in.)
OM236R	SMALL	5
OM237R	LARGE	5

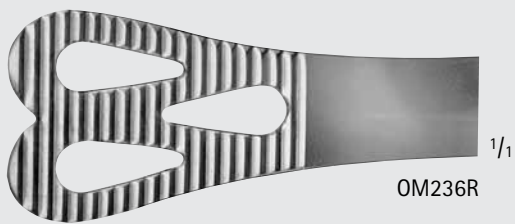

OM236R

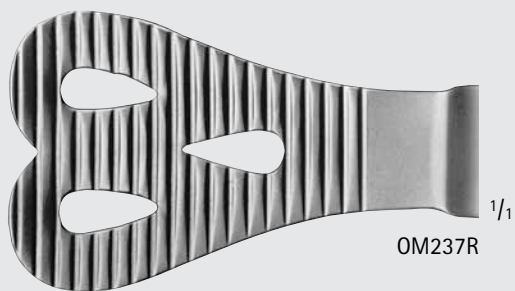

OM237R

ENT
ORAL

MILLIMETERS

ENT-ORAL

Retractors

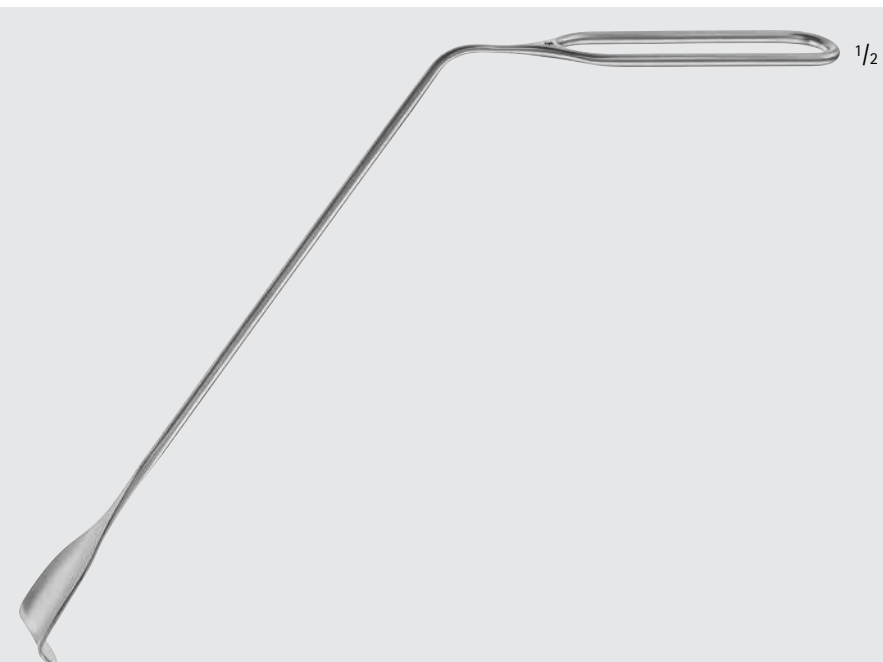

LOTHROP Uvula Retractor

Catalog Number	Blade Size (mm)	Length (in.)
MA719R	17 x 20	9 5/8

MA719R



MA719R



GOODYEAR Uvula Retractor

Catalog Number	Blade Size (mm)	Length (in.)
MA608R	15	7 3/8

MA608R



LAHEY Goiter Retractor

Catalog Number	Blade Size (mm)	Length (in.)
MB785R	24 x 8	7 7/8

MB785R



MB785R

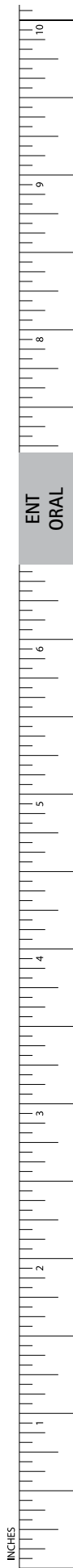

INCHES

ENT-ORAL

Retractors



MA434R-MA437R

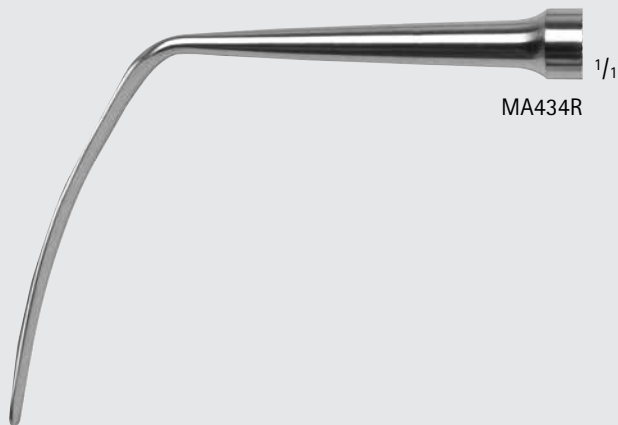

MA434R



MA436R

SEWALL Orbital Retractor

Catalog Number	Blade Size (mm)	Length (in.)
MA434R	7 x 52	6 3/4
MA435R	9 x 44	6 3/8
MA436R	11 x 50	6 3/8
MA437R	13 x 67	6 3/4



MA435R

ENT
ORAL



ENT-ORAL

Tonsil Dissectors

HURD Tonsil Dissector / Pillar Retractor

Catalog Number	Tip Size (mm)	Length (in.)
OM660R	6	8 1/2
OM661R	10	8 1/2

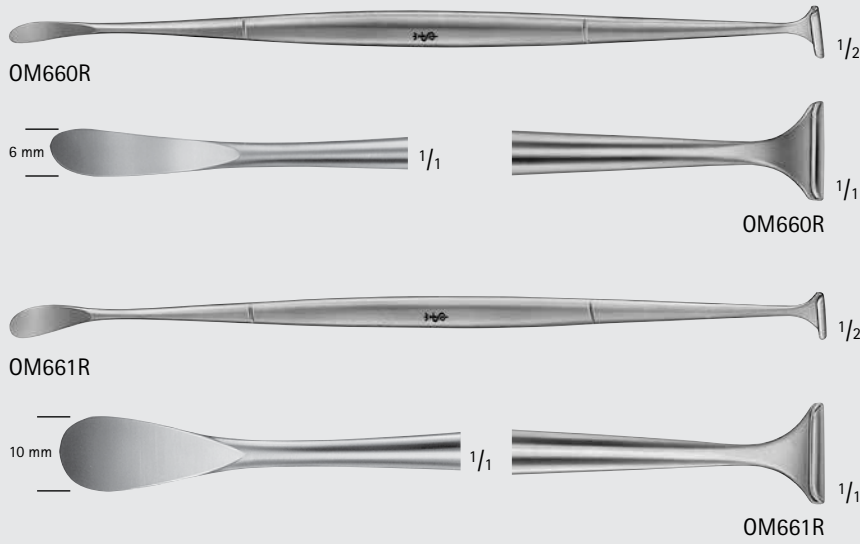

HENKE Tonsil Dissector

Catalog Number	Tip Size (mm)	Length (in.)
OM668R	12	9 1/4

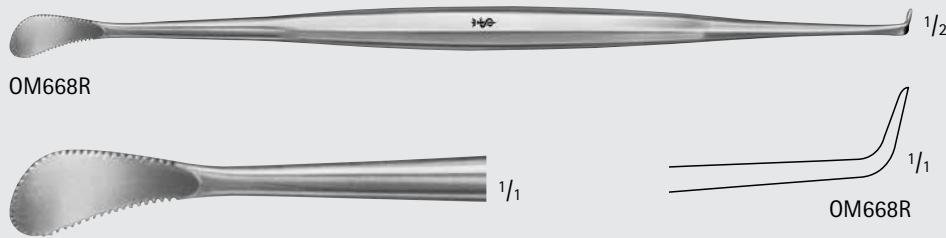

LOTHROP Tonsil Knife and Dissector

Catalog Number	Length (in.)
MA289R	8 1/4

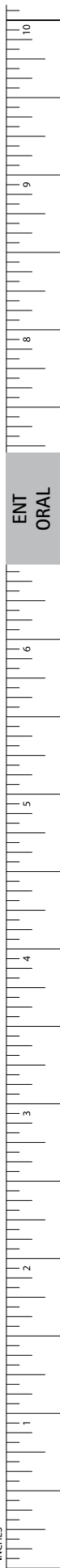

INCHES

ENT-ORAL

Adenotomes/Tonsil Snares/Wires



OM391R-OM398R

LA FORCE Adenotome

Catalog Number	Size (#)	Description	Length (in.)
OM391R	1	-	9 1/4
OM392R	2	-	9 1/4
OM393R	3	-	9 1/4
OM396R	-	SPARE BLADE F/ OM391R	-
OM397R	-	SPARE BLADE F/ OM392R	-
OM398R	-	SPARE BLADE F/ OM393R	-



OM396R



1/1

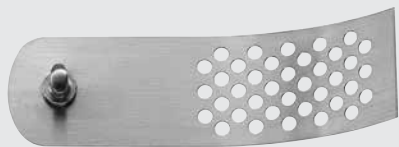

OM397R



1/1

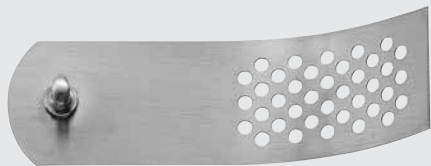

OM398R



1/1

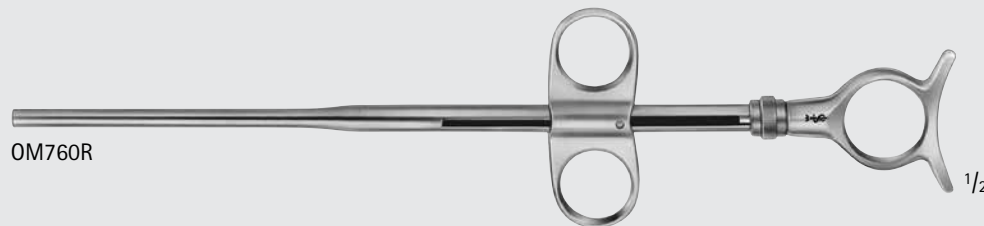

OM760R

EVES Tonsil Snare W/ 25 Gauge Wire

Catalog Number	Description	Length (in.)
OM760R	W/O RATCHET	9 3/4
OM761R	W/ RATCHET	9 3/4



OM761R

ENT ORAL

MILLIMETERS

LEWIS Tonsil Snare

Catalog Number	Description	Length (in.)
MA714R	INCLUDES 12 #8 SNARE WIRES	10 1/4

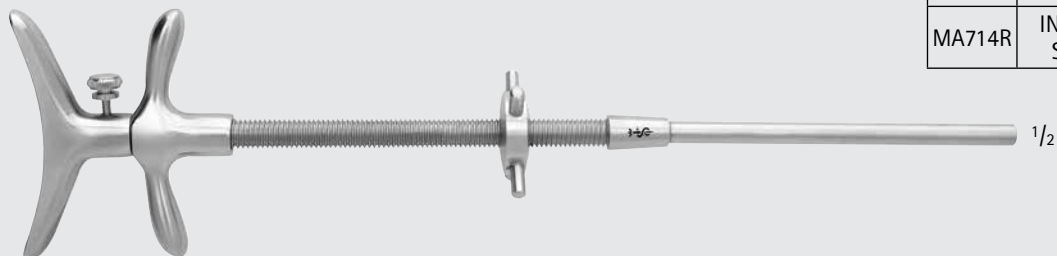

MA714R

SAGE Tonsil Snare

Catalog Number	Description	Length (in.)
MA493R	W/ SNARE WIRES	11
MA490R	12 #6 SNARE WIRES	4

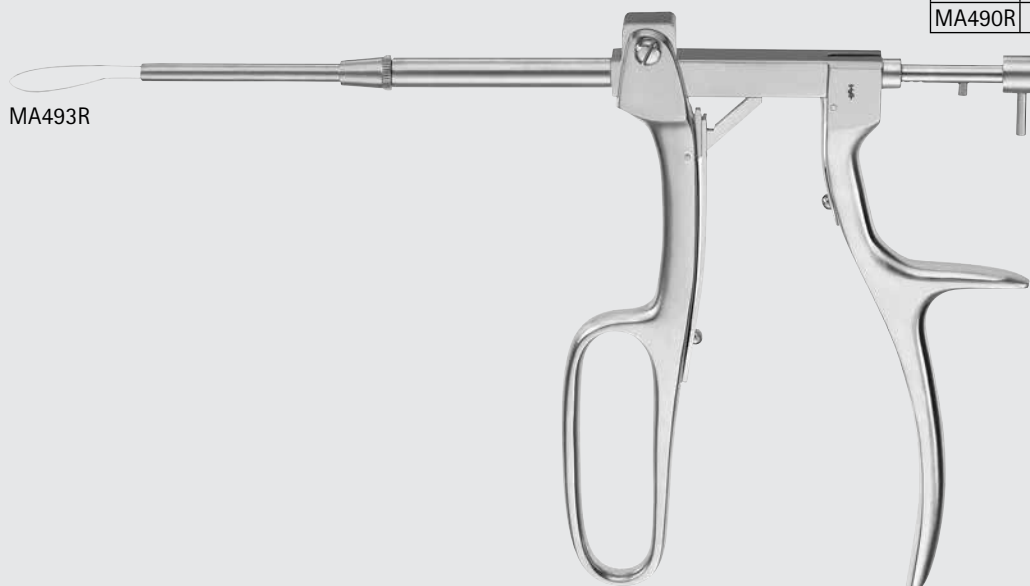

MA493R

1/2



MA490R

1/4

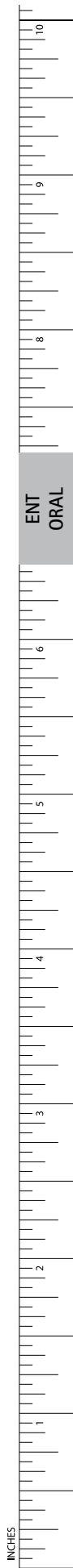

ENT ORAL

ENT-ORAL

Tonsil Snares/Wires/Adenotomes

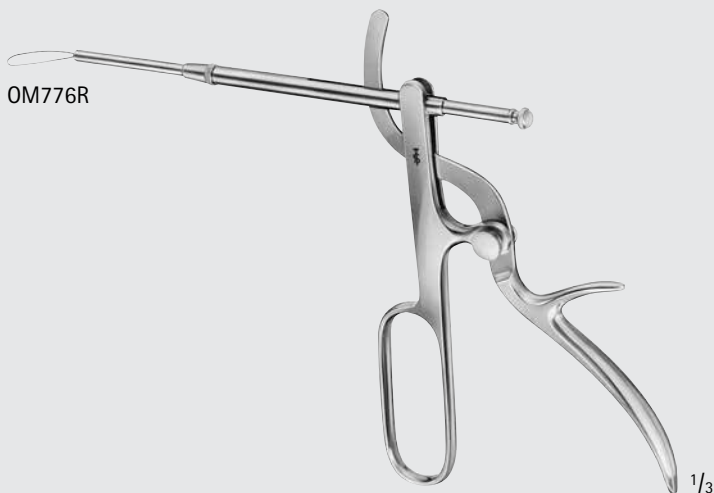

TYDING Tonsil Snare

Catalog Number	Description
OM781R	-
OM776R	TIP ONLY, STR

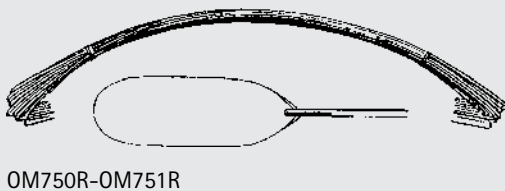

Tonsil Snare Wire

Catalog Number	Diameter (mm)	Size (#)	Sales Unit	Length (mm)
MA490R	1.4	6	12/BOX	100
OM750R	0.3	7	12/BOX	100
OM751R	0.5	8	12/BOX	100

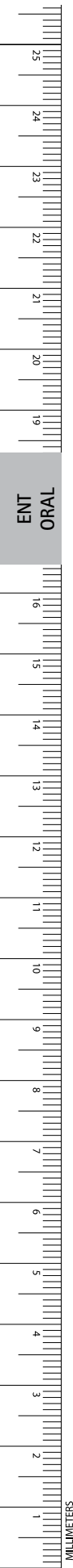

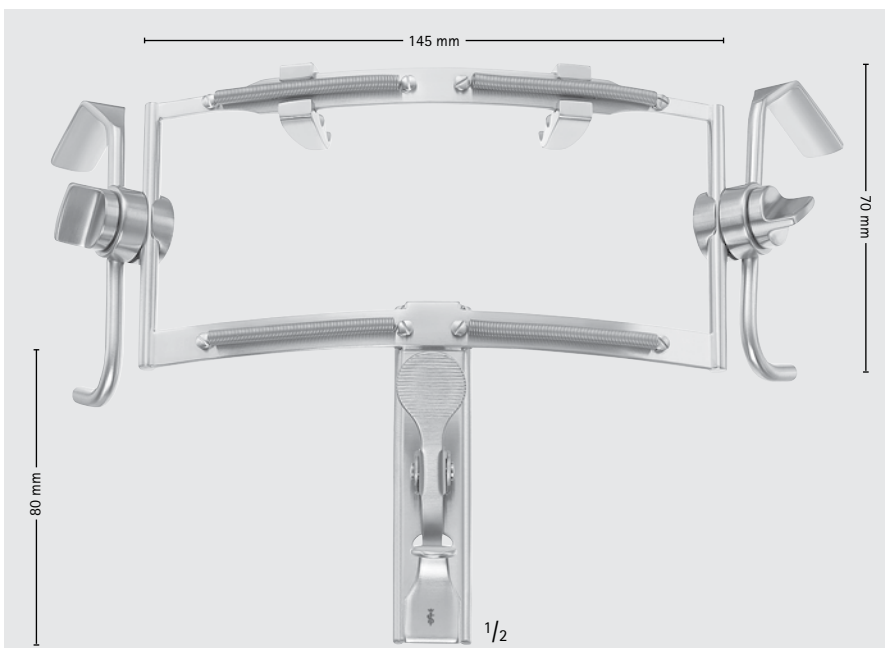

DINGMAN Mouth Gag

Catalog Number	Description
MA299R	COMPLETE SET WITH 3 BLADES AND FRAME

MA299R Includes:
 1 Mouth Gag OM105R,
 1 Blade of each OM171R, OM172R, OM177R

MA299R



MOLT Mouth Gag, Pediatric

Catalog Number	Description	Length (in.)	Length (m)
OM038R	-	4	-
TA009706	SPARE SILICONE TUBE ONLY, LATEX-FREE	-	1

TA009706 Protective covers for OM038R and OM040R available as silicone tubing which may be cut to length

OM038R



DOYEN-COLLIN Mouth Gag

Catalog Number	Description	Length (in.)	Length (m)
OM040R	-	4 3/4	-
TA009706	SPARE SILICONE TUBE ONLY, LATEX-FREE	-	1

TA009706 Protective covers for OM038R and OM040R available as silicone tubing which may be cut to length

OM040R, TA009706

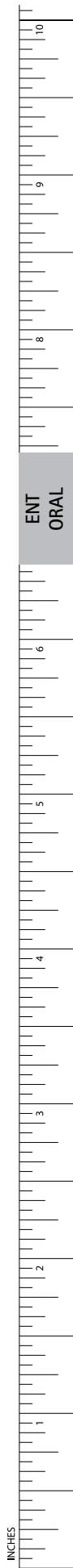

ENT-ORAL

Mouth Gags



OM041R, TA005771

DOYEN-JANSEN Mouth Gag

Catalog Number	Description	Length (in.)	Length (m)
OM041R	-	5 1/2	-
TA005771	SPARE SILICONE TUBE ONLY, LATEX-FREE	-	1

TA005771 Protective covers for OM041R available as silicone tubing which may be cut to length



OM047R

DENHARDT Mouth Gag

Catalog Number	Length (in.)
OM047R	5

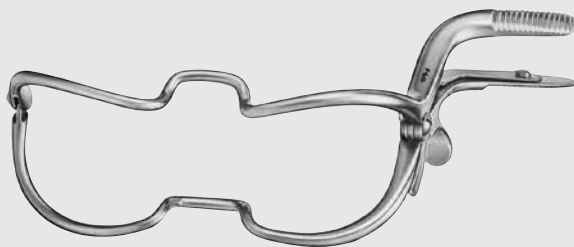

OM070R-OM073R

WHITEHEAD-JENNINGS Mouth Gag

Catalog Number	Length (in.)
OM070R	3 1/2
OM071R	4 1/4
OM072R	5 1/8
OM073R	6



OP299

Teeth Protector, Latex-Free Rubber

Catalog Number	Size
OP299	ADOLESCENT AND ADULT

DAVIS Mouth Gag

Catalog Number	Blade Size (mm)	Size (#)	Description	Length (in.)
MA302R	-	-	COMPLETE SET, RIGHT	-
MA303R	-	-	COMPLETE SET, LEFT	-
MA307R	-	-	RIGHT FRAME ONLY	6
MA304R	20 x 34	1	BLADE	5 1/4
MA305R	23 x 64	2	BLADE	5 1/4
MA306R	25 x 79	3	BLADE	5 1/4
MA308R	25 x 85	3 1/2	BLADE	5 1/8
MA309R	25 x 95	4	BLADE	5 1/8
MA310R	25 x 106	5	BLADE	5 1/8
OM170	SILICONE INSERT			

MA302R Includes:

1 Blades w/ Tube of each MA304R, MA307R, OM112R, MA315R, OM114R, OM115R

MA303R Includes:

1 Blades w/ Tube of each OM116R, MA304R, OM112R, MA315R, OM114R, OM115R



MA307R



MA304R



MA305R



MA306R



MA308R



MA309R



MA310R

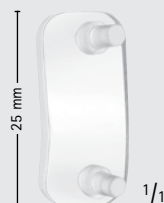

OM170

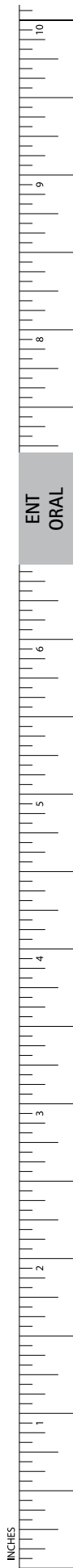

INCHES

ENT-ORAL

Mouth Gags



MA315R



MA319R

DAVIS Mouth Gag W/ Tube

Catalog Number	Blade Size (mm)	Size (#)
MA315R	24 x 80	3
MA319R	25 x 90	3

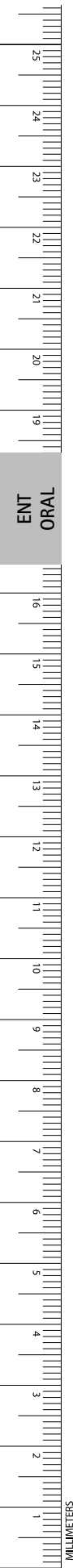

DAVIS-BOYLE Mouth Gag

Catalog Number	Blade Size (mm)	Size	Description	Length (in.)
OM118R	-	CHILD	FRAME ONLY	5 1/4
OM119R	-	TEEN	FRAME ONLY	5 3/4
OM116R	-	ADULT	FRAME ONLY	6 3/4
OM112R	25 x 62	-	BLADE	-
OM113R	25 x 75	-	BLADE	-
OM114R	25 x 92	-	BLADE	-
OM115R	25 x 108	-	BLADE	-
OM170	SILICONE INSERT			



OM118R



OM119R



OM116R



OM112R-OM115R

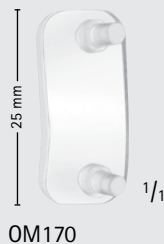

OM170

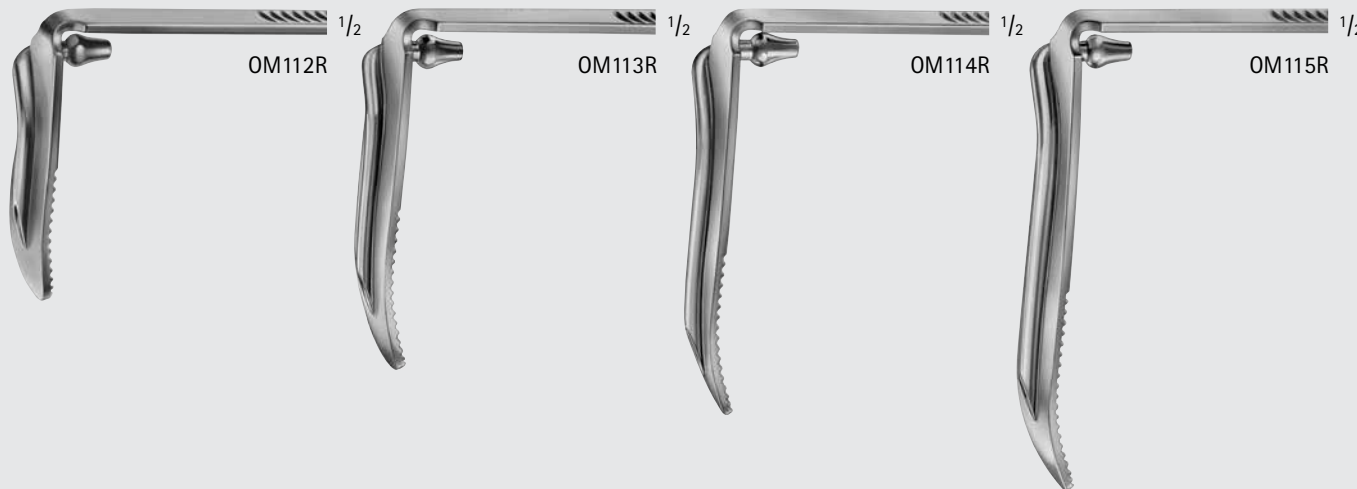

OM112R

OM113R

OM114R

OM115R

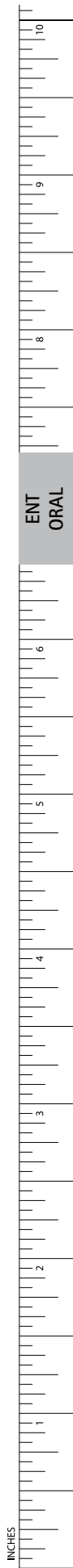

INCHES

ENT ORAL

ENT-ORAL

Mouth Gags

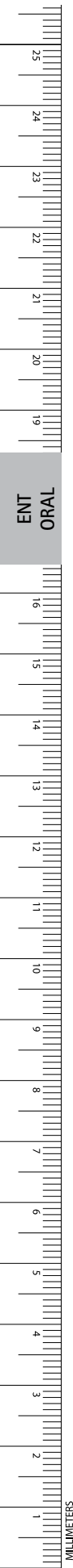

OM169R



OM170



OM179R

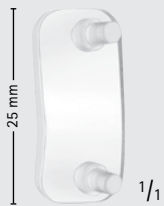

DAVIS-MEYER Tongue Depressor Frame

Catalog Number	Description
OM169R	FRAME, COMPLETE
OM170	SILICONE INSERT
OM179R	PALATE BLADE

MCIVOR Mouth Gag

Catalog Number	Blade Size (mm)	Size (#)	Description	Length (in.)
MA311R	-	-	COMPLETE WITH FRAME AND 3 TONGUE BLADES	-
MA312R	22 x 69	1	BLADE	5 3/8
MA313R	24 x 90	2	BLADE	5 3/8
MA314R	25 x 100	3	BLADE	5 3/8
OM104R	-	-	FRAME F/ TONGUE DEPRESSOR	5 1/2
OM104201	-	-	REPLACEMENT TUBE F/ OM104R	-
OM101R	25 x 55	-	BLADE	-
OM102R	25 x 62	-	BLADE	-
OM103R	25 x 75	-	BLADE	-
MB595R	57 x 23	2	BLADE, RIGHT	-
MB596R	72 x 27	3	BLADE, RIGHT	-
MB597R	88 x 33	4	BLADE, RIGHT	-
MB598R	57 x 23	2	BLADE, LEFT	-
MB599R	72 x 27	3	BLADE, LEFT	-
MB600R	88 x 33	4	BLADE, LEFT	-
MA301R	97 x 36	5	BLADE, LEFT	-
MA300R	97 x 36	5	BLADE, RIGHT	-

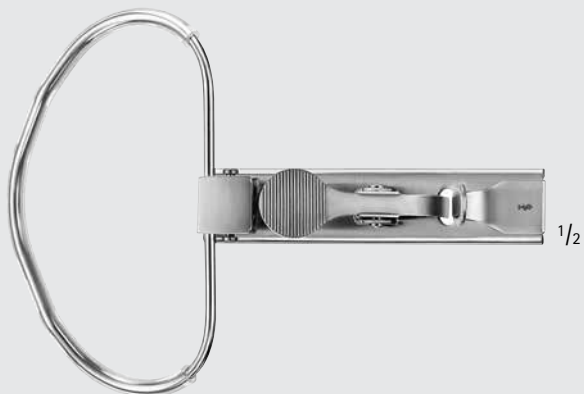

MA311R



MA312R-MA314R

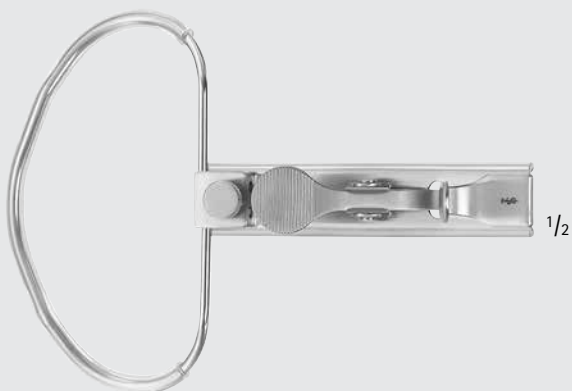

OM104R



OM101R-OM103R

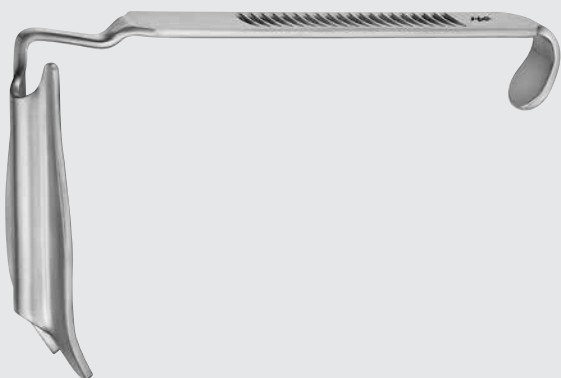

MB595R-MB600R



MA300R-MA301R

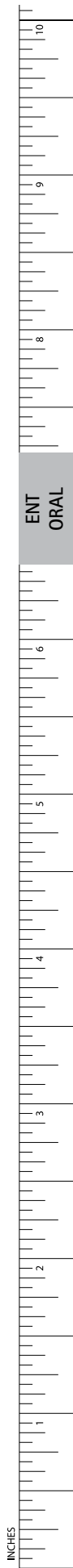

ENT ORAL

INCHES

ENT-ORAL

Mouth Gags



OM171R-OM178R

RUSSEL-DAVIS Tongue Blade

Catalog Number	Blade Size (mm)
OM171R	29 x 67
OM172R	33 x 75
OM173R	38 x 85
OM174R	40 x 92
OM175R	46 x 100
OM176R	18 x 57
OM177R	22 x 67
OM178R	25 x 75



OM171R



OM172R



OM173R



OM174R



OM175R



OM176R



OM177R



OM178R

ENT
ORAL

MILLIMETERS

GAST Tongue Blade

Catalog Number	Blade Size (mm)
OM181R	28 x 64
OM182R	34 x 74
OM183R	38 x 87



OM181R-OM183R



OM181R

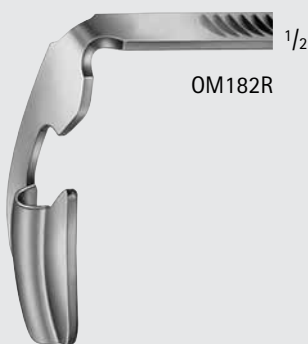

OM182R



OM183R

DRAFFIN Chest Support, W/ 4 Height Rings

Catalog Number	Length (in.)
OM186R	18 7/8

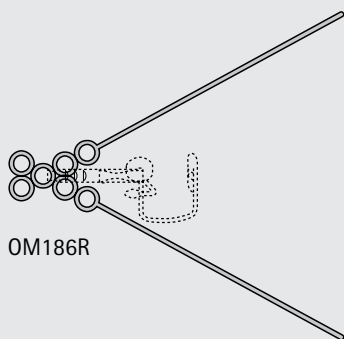

OM186R

MAGAUAN Plate, F/ Holding OM186R

Catalog Number	Length (in.)
OM187R	16

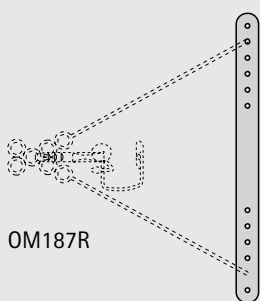

OM187R

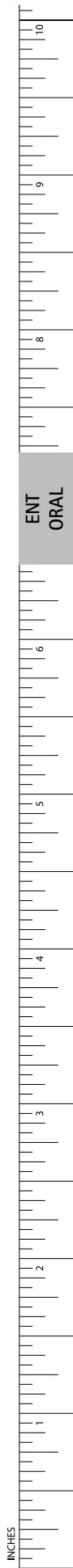

INCHES

ENT-ORAL

Tonsil Knives



OM681R



OM681R

ABRAHAM Tonsil Knife

Catalog Number	Length (in.)
OM681R	8 3/4



OM688R



OM688R

FISHER Tonsil Knife

Catalog Number	Length (in.)
OM688R	8

ENT
ORAL

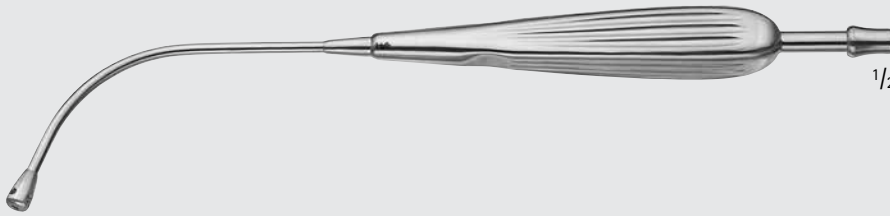

ANDREWS Pynchon Suction Tube

Catalog Number	Description	Length (in.)
MD613	-	9
MD613001	TIP ONLY F/ MD613	-

MD613



MD613001

OP360R-OP362R

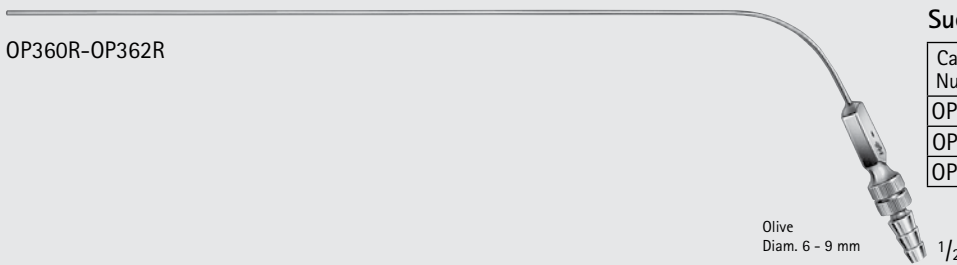

Suction Tube, W/ Finger Cut-Off

Catalog Number	Tip Size (mm)	Working Length (in.)
OP360R	2.0	9 3/4
OP361R	2.5	9 3/4
OP362R	3.0	9 3/4

Olive
Diam. 6 - 9 mm

MB366R-MB369R

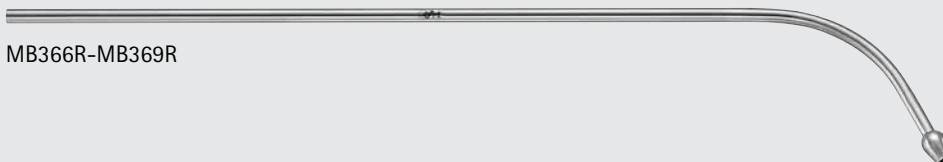

JACKSON Velvet Eye Aspirating Tube

Catalog Number	Diameter (mm)	Length (in.)
MB366R	4.0	10
MB367R	4.0	16 3/8
MB368R	4.0	22
MB369R	4.0	18 1/8



ENT
ORAL

INCHES

ENT-ORAL

Curettes



OM471R-OM474R

BARNHILL Adenoid Curette

Catalog Number	Tip Size (mm)	Length (in.)
OM471R	11	7 7/8
OM472R	13	7 7/8
OM473R	15	7 7/8
OM474R	17	7 7/8

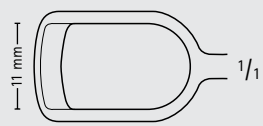

OM471R



OM472R



OM473R

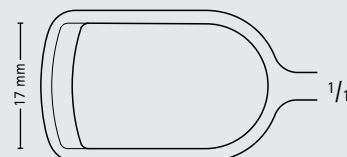

OM474R



OM451R-OM456R

BECKMANN Adenoid Curette

Catalog Number	Tip Size (mm)	Length (in.)
OM451R	9.25	7 7/8
OM452R	11.5	7 7/8
OM453R	12	7 7/8
OM454R	13	7 7/8
OM455R	15.5	7 7/8
OM456R	16	7 7/8
OM500R	10	8 3/4
OM501R	12	8 3/4
OM502R	14	8 3/4
OM503R	16	8 3/4
OM504R	18	8 3/4
OM505R	20	8 3/4

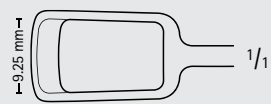

OM451R



OM452R

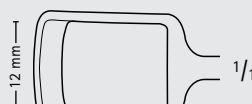

OM453R



OM454R



OM455R



OM456R



OM500R-OM505R



OM500R



OM501R



OM502R

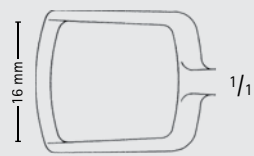

OM503R



OM504R



OM505R

ENT
ORAL



MA654R-MA656R

JONES Adenoid Curette

Catalog Number	Tip Size (mm)	Size (#)	Size	Length (in.)
MA656R	4	1	INFANT	8 3/4
MA655R	6	2	CHILD	8 7/8
MA654R	8	3	ADULT	8 7/8



MA656R



MA655R



MA654R



MA291R

MIDDLETON Adenoid Curette

Catalog Number	Tip Size (mm)	Length (in.)
MA291R	7	8 7/8



MA291R



OM510R-OM514R

NEGUS Adenoid Curette

Catalog Number	Tip Size (mm)	Length (in.)
OM510R	10	7 7/8
OM511R	12.25	7 7/8
OM512R	14	7 7/8
OM513R	16.5	7 7/8
OM514R	18	7 7/8

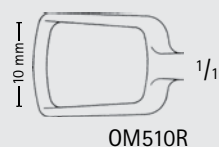

OM510R

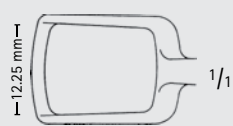

OM511R

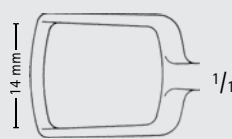

OM512R



OM513R



OM514R

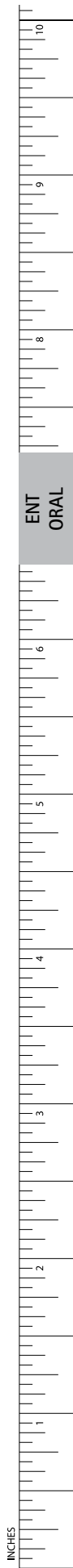

INCHES

ENT-ORAL

Curettes



US149-US150

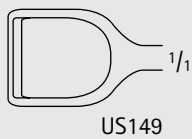

US149

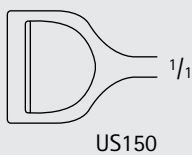

US150



MA066R-MA067R

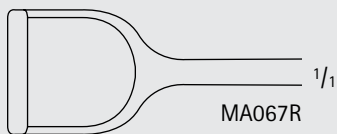

MA067R

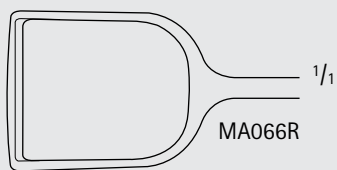

MA066R

STUBBS Adenoid Curette

Catalog Number	Tip Size (mm)	Size (#)	Length (in.)
US149	11	0	8 1/2
US150	14	1	8 1/2
MA067R	16	2	8 1/2
MA066R	18	3	8 1/2



MB316R



MB316R

VOGEL Adenoid Curette, Infant

Catalog Number	Tip Size (mm)	Length (in.)
MB316R	7	8 1/2

ENT
ORAL

MILLIMETERS

ENT-ORAL Syringes

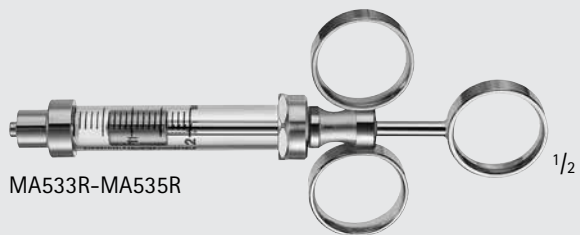

Syringe

Catalog Number	Diameter (mm)	Volume (cc)	Length (in.)
MA533R	11	3	5 1/2
MA534R	14	5	5 1/2
MA535R	17	10	5 1/2

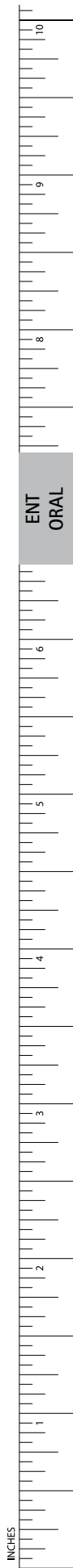

INCHES

ENT-ORAL

Laryngeal Mirrors



OM078R-OM090R

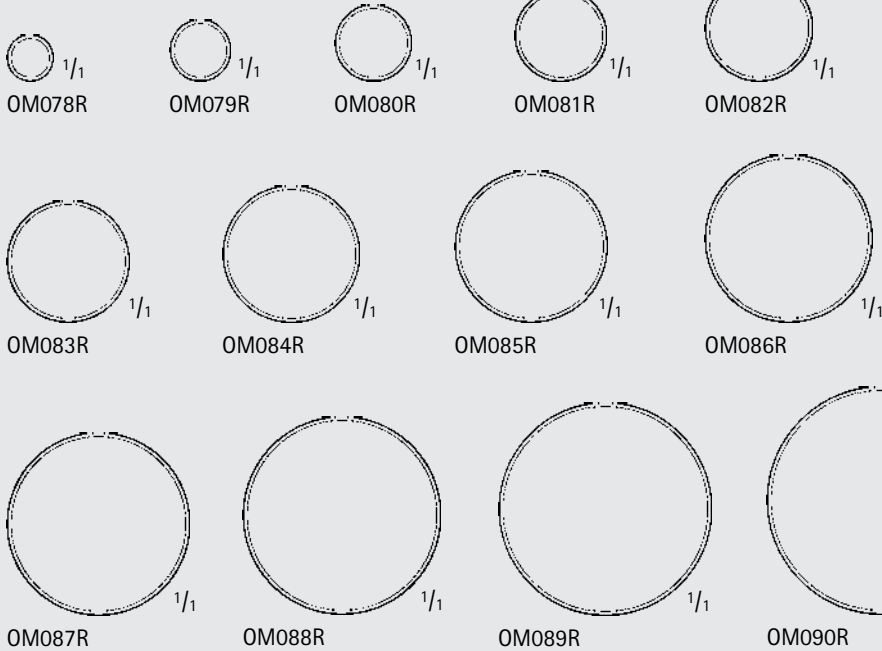

Laryngeal Mirror, Rigid, W/ Hex Handle

Catalog Number	Size (#)	Diameter (mm)	Length (in.)
OM078R	000	6.0	7
OM079R	00	8.0	7
OM080R	0	10.0	7
OM081R	1	12.0	7
OM082R	2	14.0	7
OM083R	3	16.0	7
OM084R	4	18.0	7
OM085R	5	20.0	7
OM086R	6	22.0	7
OM087R	7	24.0	7
OM088R	8	26.0	7
OM089R	9	28.0	7
OM090R	10	30.0	7

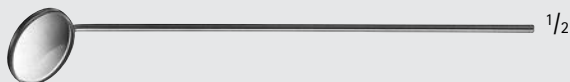

AC468R-AC480R



AC481R

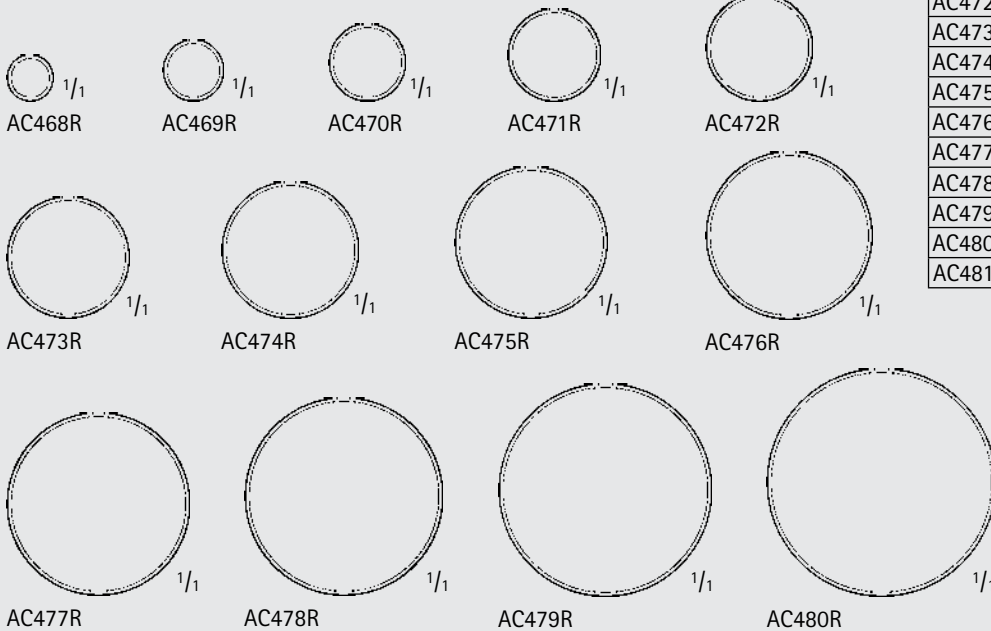

Laryngeal Mirror, Rigid, F/ Handle
AC481R

Catalog Number	Size (#)	Diameter (mm)	Length (in.)
AC468R	000	6.0	4 3/4
AC469R	00	8.0	4 3/4
AC470R	0	10.0	4 3/4
AC471R	1	12.0	4 3/4
AC472R	2	15.0	4 3/4
AC473R	3	16.0	4 3/4
AC474R	4	18.0	4 3/4
AC475R	5	20.0	4 3/4
AC476R	6	22.0	4 3/4
AC477R	7	24.0	4 3/4
AC478R	8	26.0	4 3/4
AC479R	9	28.0	4 3/4
AC480R	10	30.0	4 3/4
AC481R	-	HANDLE	4 1/4

ENT
ORAL

MILLIMETERS

ENT-ORAL

Amalgam Carriers



Amalgam Carrier, Double Ended

Catalog Number	Size	Length (in.)
MG574R	MEDIUM / LARGE	7 7/8

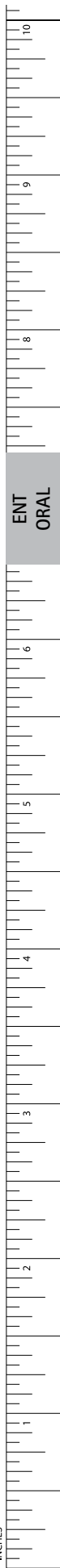
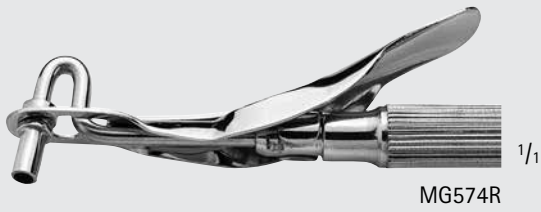

ENT-ORAL

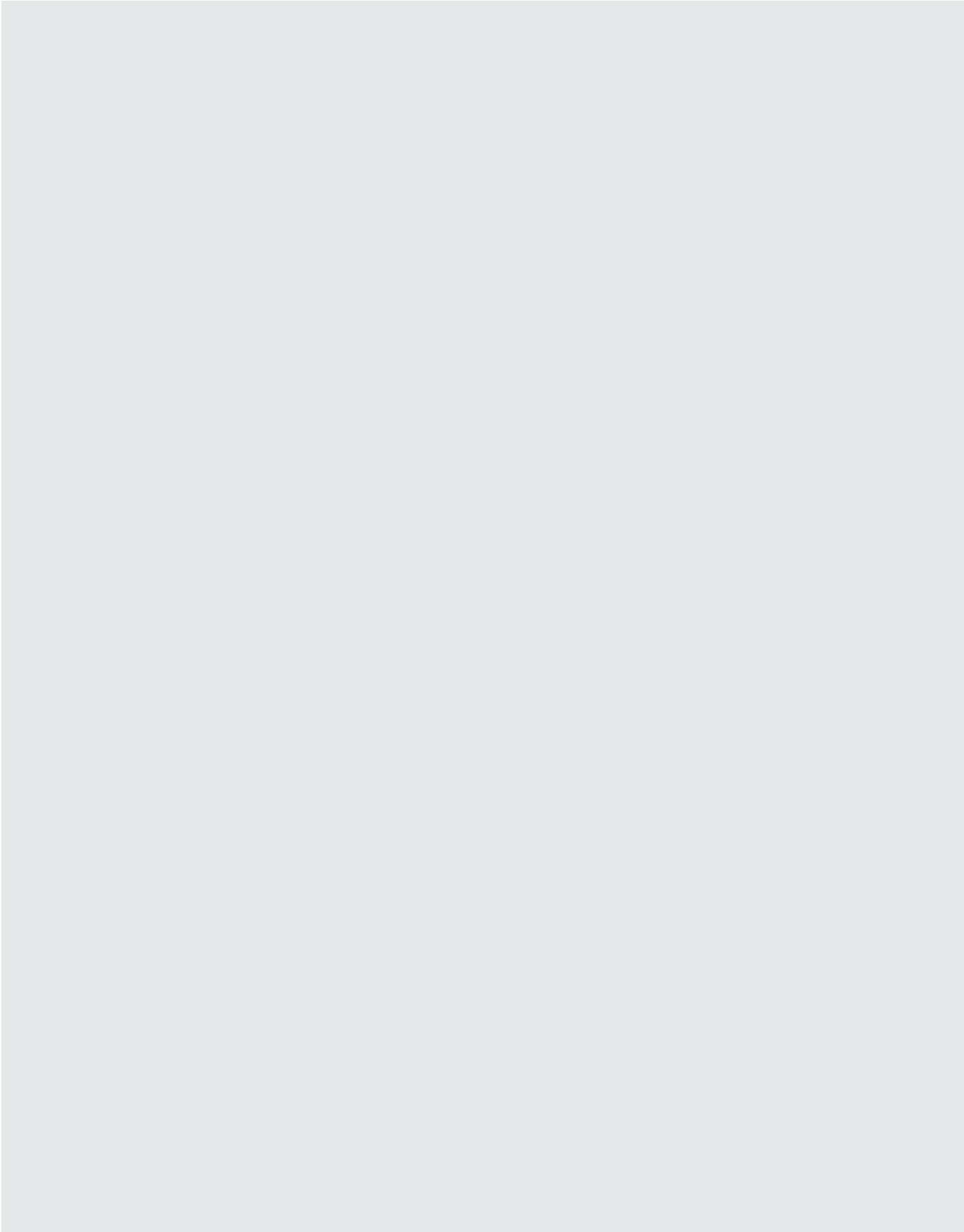
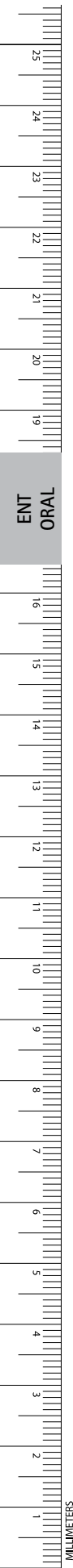



Plastic Surgery

Scissors	748 - 768
Needle Holders	768 - 772
Forceps	773 - 782
Hooks and Retractors	783 - 793
Aluminum Hand	794
Knives	795 - 797
Suction Instruments	798
Bone Instruments	799 - 807
Micro Vessel Clips and Clamps	808 - 810

Plastic Surgery

Scissors

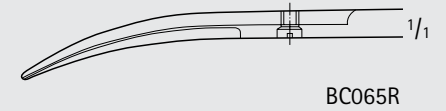
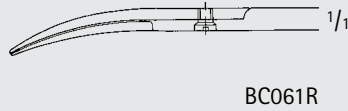
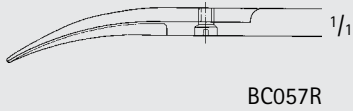
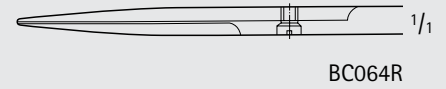
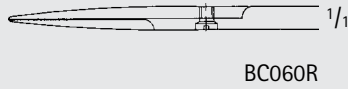
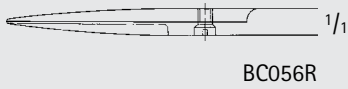
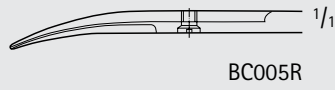
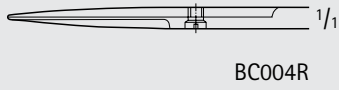
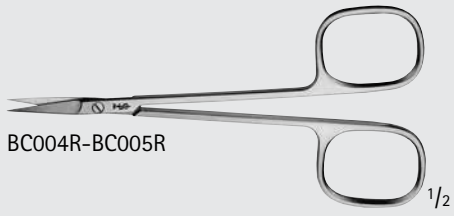

Iris Scissors, Delicate

Catalog Number	Tip	Blade	Handle	Length (in.)
BC004R	S/S	STR	SQUARE	4 1/2
BC005R	S/S	CVD	SQUARE	4 1/2
BC056R	S/S	STR	ROUND	3 3/4
BC060R	S/S	STR	ROUND	4 1/8
BC064R	S/S	STR	ROUND	4 3/4
BC057R	S/S	CVD	ROUND	3 3/4
BC061R	S/S	CVD	ROUND	4 1/8
BC065R	S/S	CVD	ROUND	4 3/4

PLASTIC SURGERY

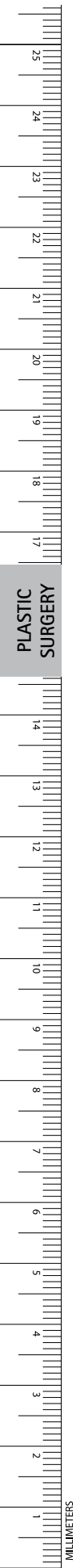

Iris Scissors, Ribbon Handle

Catalog Number	Tip	Blade	Length (in.)
MB605R	S/S	STR	4
BC190R	S/S	CVD	4



Suture Scissors

Catalog Number	Tip	Blade	Length (in.)
BC130R	S/S	STR	4 3/4
BC140R	S/S	STR	5 1/8
BC144R	B/B	STR	5 1/8
BC135R	B/B	CVD, DEL	4 3/4
BC131R	S/S	CVD	4 3/4
BC141R	S/S	CVD	5 1/8
BC145R	B/B	CVD	5 1/8

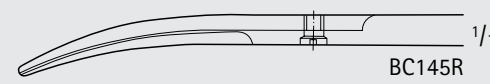
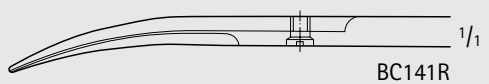
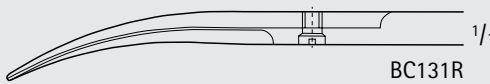
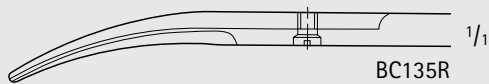
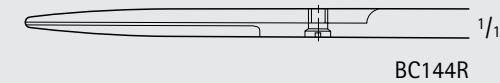
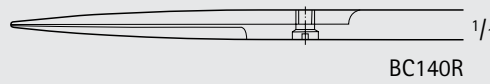
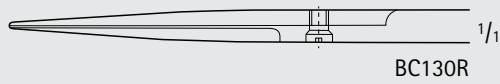

Plastic Surgery

Scissors

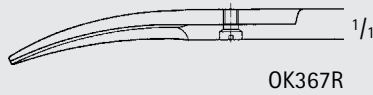
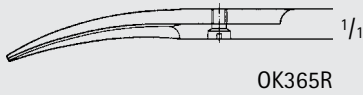
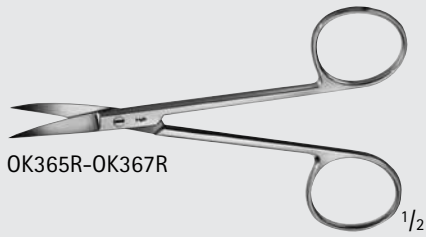

COTTLE-MASING Plastic Scissors

Catalog Number	Tip	Blade	Length (in.)
OK365R	S/S	CVD	4 1/8
OK367R	B/B	CVD	4 1/8

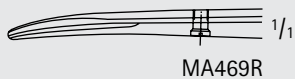
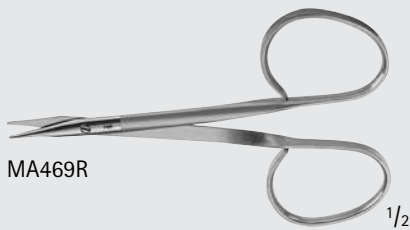
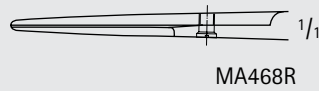
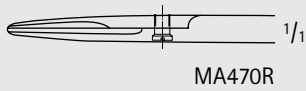
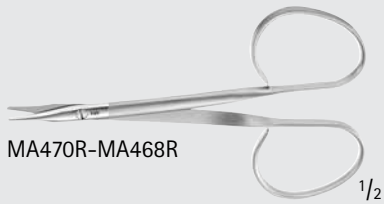

STEVENS Tenotomy Scissors

Catalog Number	Tip	Blade	Handle	Weight	Length (in.)
MA470R	B/B	STR	RIBBON	LIGHT	3 3/4
MA468R	B/B	STR	RIBBON	HEAVY	3 7/8
MA469R	B/B	CVD	RIBBON	HEAVY	3 3/4

STEVENS Tenotomy Scissors
(continued)

Catalog Number	Tip	Blade	Handle	Length (in.)
BC008R	S/S	STR	SQUARE	4 1/2
BC010R	B/B	STR	SQUARE	4 1/2
BC009R	S/S	CVD	SQUARE	4 1/2
BC011R	B/B	CVD	SQUARE	4 1/2
BC170R	S/S	STR	ROUND	4 1/4
BC172R	B/B	STR	ROUND	4 1/4
MA467R	B/B	STR	ROUND	5 3/4
BC171R	S/S	CVD	ROUND	4 1/4
BC173R	B/B	CVD	ROUND	4 1/4
MA466R	B/B	CVD	ROUND	5 3/4

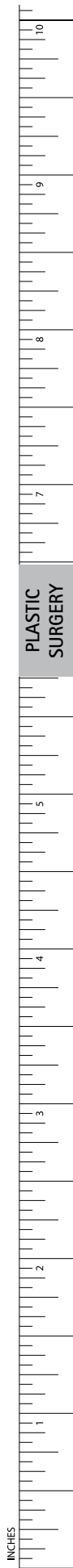
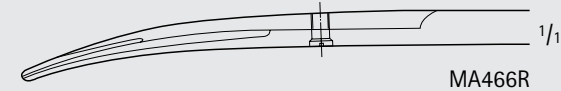
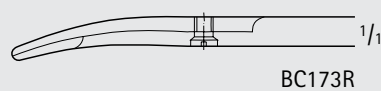
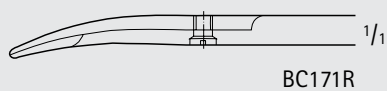
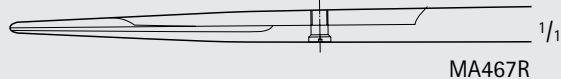
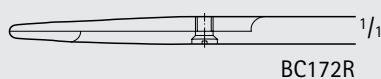
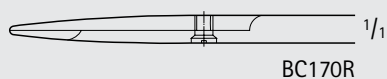
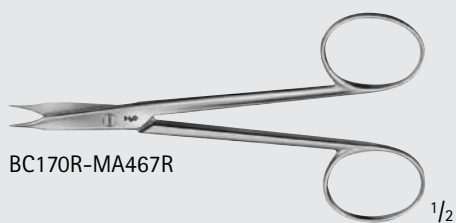
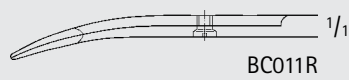
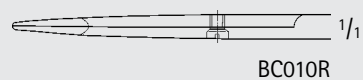
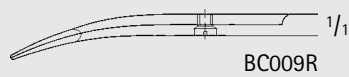
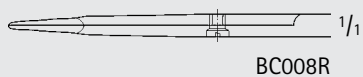
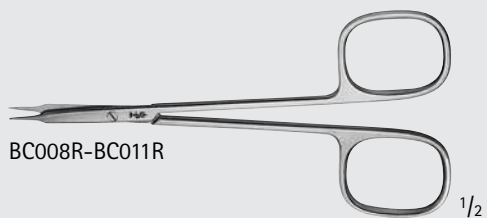

INCHES

PLASTIC SURGERY

Plastic Surgery

Scissors

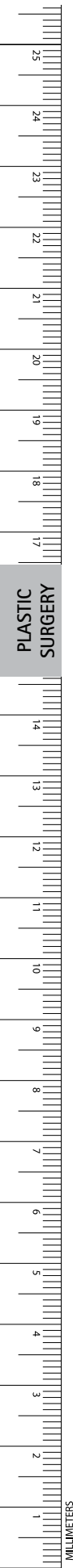

BC194R-BC195R

1/2

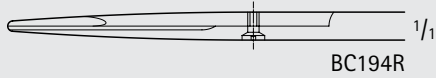

BC194R

1/1

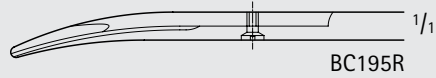

BC195R

1/1

STEVENS Tenotomy Scissors, Delicate

Catalog Number	Tip	Blade	Length (in.)
BC194R	B/B	STR	5
BC195R	B/B	CVD	5

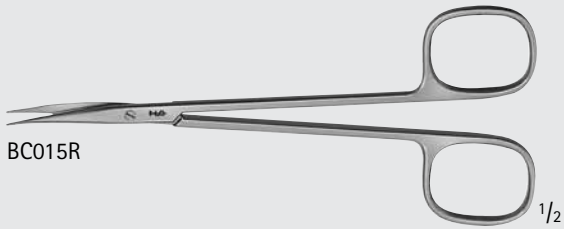

BC015R

1/2

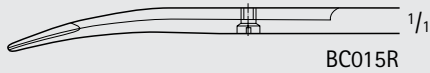

BC015R

1/1

REYNOLDS-JAMESON Tenotomy Scissors, Delicate

Catalog Number	Tip	Blade	Handle	Length (in.)
BC015R	B/B	CVD	SQUARE	5 1/2

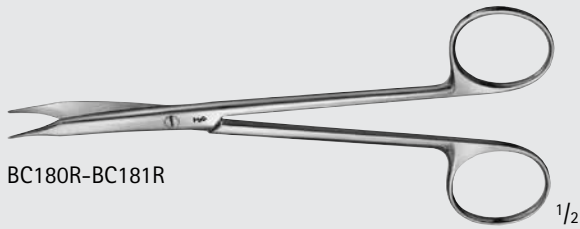

BC180R-BC181R

1/2

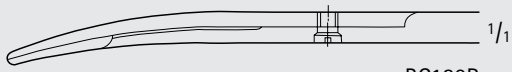

BC180R

1/1

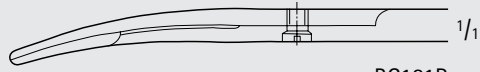

BC181R

1/1

REYNOLDS Tenotomy Scissors, Delicate

Catalog Number	Tip	Blade	Length (in.)
BC180R	B/B	CVD	5 3/4
BC181R	B/B	CVD	6 7/8

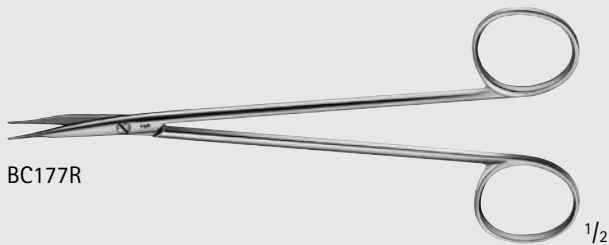

BC177R

1/2

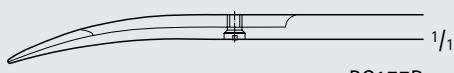

BC177R

1/1

JAMESON Tenotomy Scissors, Delicate

Catalog Number	Tip	Blade	Length (in.)
BC177R	B/B	CVD	6

JAMESON SuperCut Scissors, Delicate

Catalog Number	Tip	Blade	Length (in.)
BC911R	B/B	CVD	5 1/8
BC915R	B/B	CVD	6
BC919R	B/B	CVD	7



BC911R, BC915R, BC919R

1/2



BC911R

1/1



BC915R

1/1



BC919R

1/1

POTTS Tenotomy Scissors

Catalog Number	Tip	Blade	Length (in.)
BC178R	B/B	CVD	6 7/8
BC179R	B/B	CVD	8

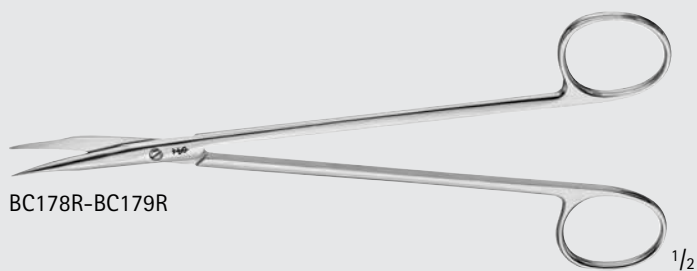

BC178R-BC179R

1/2



BC178R

1/1

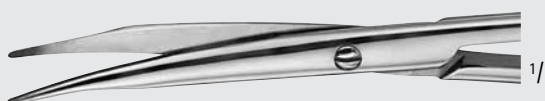

BC179R

1/1

Nerve Dissecting Scissors

Catalog Number	Tip	Blade	Length (in.)
BC628R	S/S	CVD	6

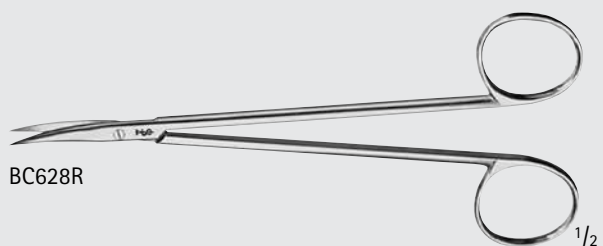

BC628R

1/2

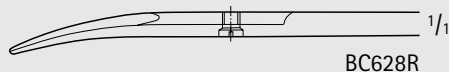

BC628R

1/1

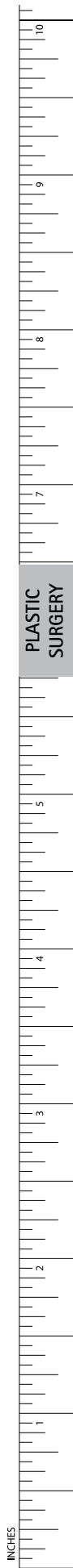

PLASTIC SURGERY

INCHES

Plastic Surgery

Scissors



BC006R-BC007R

JOSEPH Scissors, Delicate

Catalog Number	Tip	Blade	Handle	Length (in.)
BC006R	S/S	STR	SQUARE	6
BC007R	S/S	CVD	SQUARE	6
BC156R	S/S	STR	ROUND	6
BC157R	S/S	CVD	ROUND	6

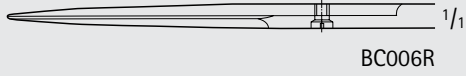

BC006R

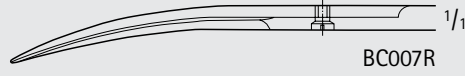

BC007R

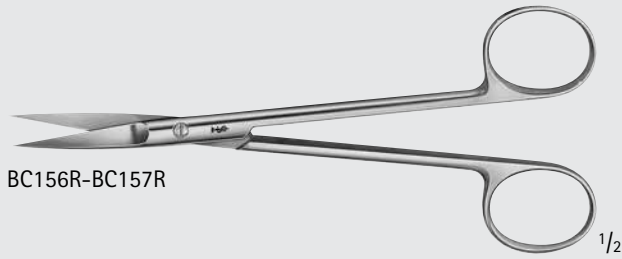

BC156R-BC157R

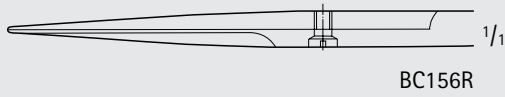

BC156R

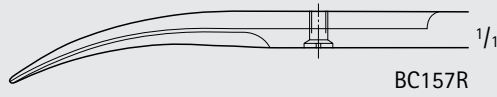

BC157R

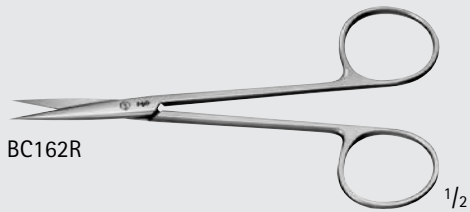

BC162R

KILNER Scissors

Catalog Number	Tip	Blade	Length (in.)
BC162R	S/S	STR	4 1/2
BC166R	FLAT	CVD	5
BC168R	FLAT	CVD	6

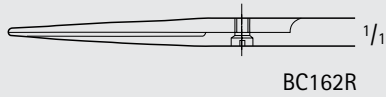

BC162R

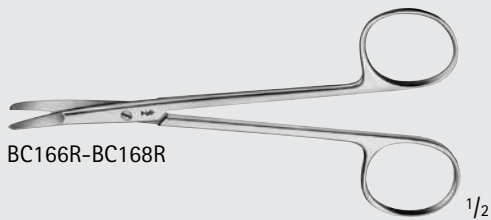

BC166R-BC168R

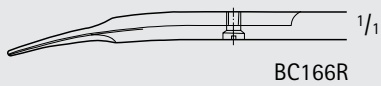

BC166R

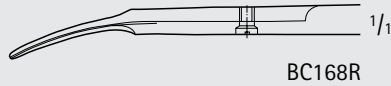

BC168R

PLASTIC SURGERY

Strabismus Scissors

Catalog Number	Tip	Blade	Length (in.)
BC164R	B/B	STR	4 1/2
BC165R	B/B	CVD	4 1/2

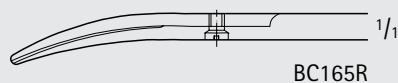
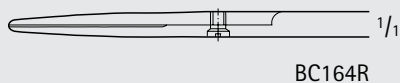
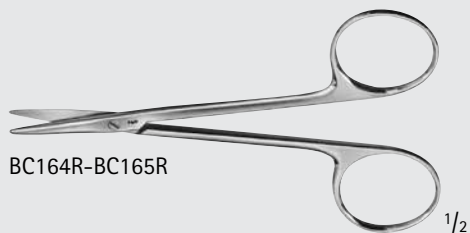

LITTLER Scissors

Catalog Number	Tip	Blade	Length (in.)
BC163R	W/EYE	CVD	4 1/2

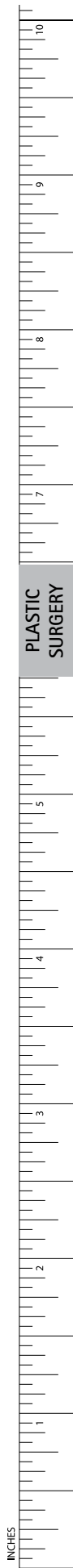
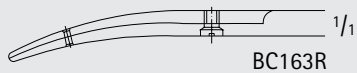

Plastic Surgery

Scissors

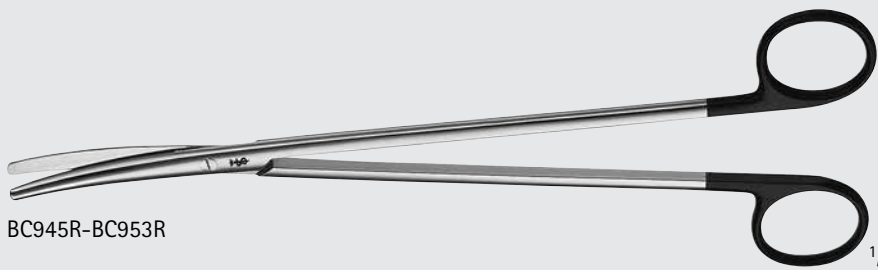
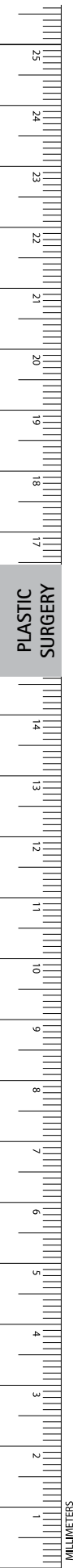

BC945R-BC953R

METZENBAUM SuperCut Scissors

Catalog Number	Tip	Blade	Length (in.)
BC945R	B/B	CVD	9
BC947R	B/B	CVD	10 1/4
BC949R	B/B	CVD	11 1/4
BC951R	B/B	CVD	11 3/4
BC953R	B/B	CVD	14

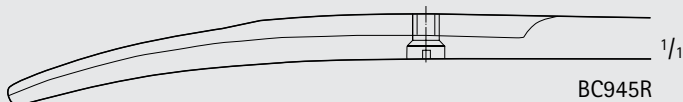

BC945R

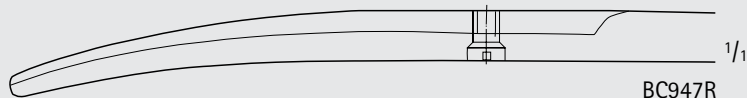

BC947R

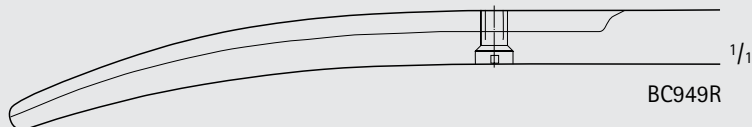

BC949R

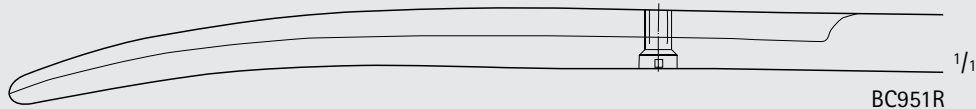

BC951R

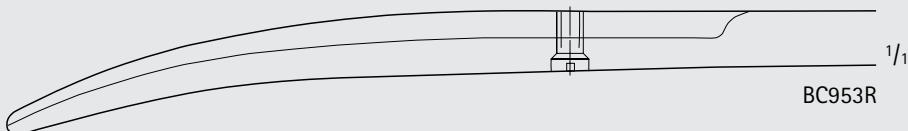

BC953R

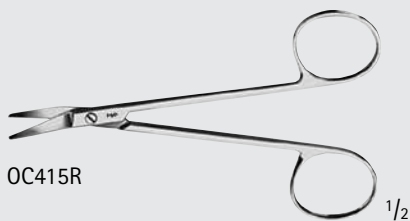

OC415R

GRAEFE Scissors

Catalog Number	Tip	Blade	Length (in.)
OC415R	B/B	LAT-ANG	4

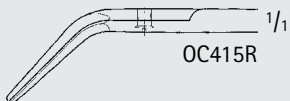

OC415R

FOMON Lower Lateral Scissors

Catalog Number	Tip	Blade	Length (in.)
OK373R	B/B	HEAVY-CVD	4 1/2
OK372R	B/B	HEAVY-CVD	5 1/4

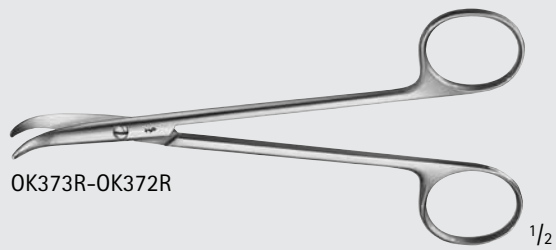

OK373R-OK372R

1/2

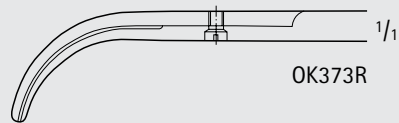

OK373R

1/1

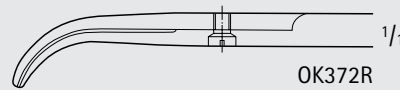

OK372R

1/1

SPENCER Suture Scissors

Catalog Number	Blade	Length (in.)
BC801R	STR	3 1/2
BC802R	STR	4 1/2



BC801R-BC802R

1/2

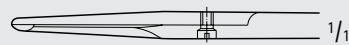

BC801R

1/1



BC802R

1/1

LITTAUER Ligature Scissors

Catalog Number	Blade	Length (in.)
BC803R	STR	5 1/4



BC803R

1/2



BC803R

1/1



PLASTIC SURGERY

INCHES

Plastic Surgery

Scissors

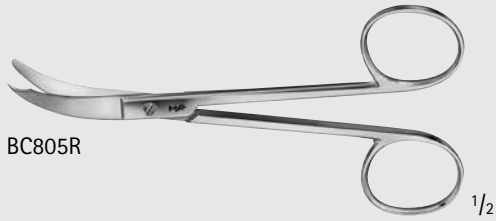

BC805R

1/2

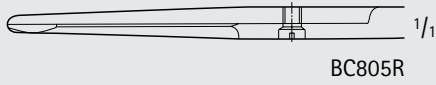

BC805R

1/1

NORTHBENT Ligature Scissors

Catalog Number	Tip	Blade	Length (in.)
BC805R	B/B	LAT-CVD	4 3/4

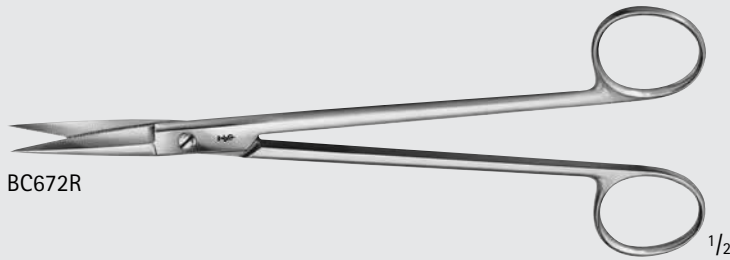

BC672R

1/2

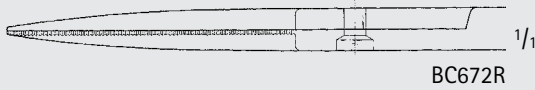

BC672R

1/1

Cartilage Scissors

Catalog Number	Tip	Blade	Length (in.)
BC672R	S/S	SERR	7 1/4

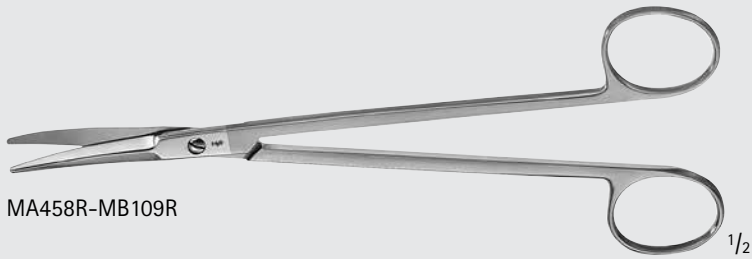

MA458R-MB109R

1/2

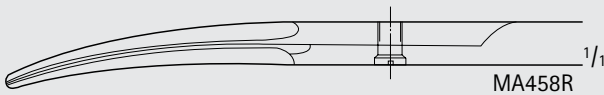

MA458R

1/1

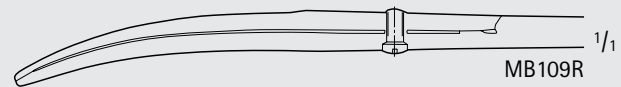

MB109R

1/1

KAYE Facelift Scissors

Catalog Number	Tip	Blade	Length (in.)
MA458R	SEMI-SHARP	CVD, SERR	6
MB109R	SEMI-SHARP	CVD, SERR	7 1/2



MB150R

1/2

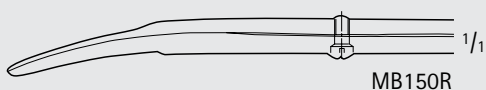

MB150R

1/1

METZENBAUM-LIPSETT Scissors

Catalog Number	Tip	Blade	Length (in.)
MB150R	B/B	CVD	5 1/2

PLASTIC SURGERY

GORNEY Scissors

Catalog Number	Tip	Blade	Length (in.)
BC184R	B/B	STR	5
BC188R	B/B	STR	7 3/4
BC189R	B/B	SLIGHT-CVD	7 3/4

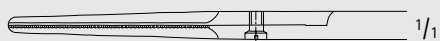

BC184R



BC188R

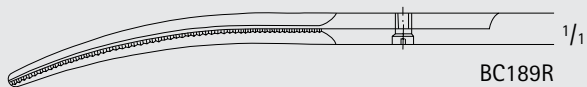

BC189R

GORNEY-FREEMAN SuperCut Scissors

Catalog Number	Tip	Blade	Length (in.)
MB632R	BEVELED BLUNT	STR	7 1/4
MB633R	BEVELED BLUNT	CVD	7 1/4

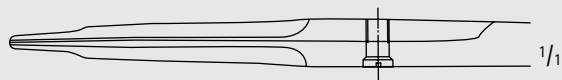
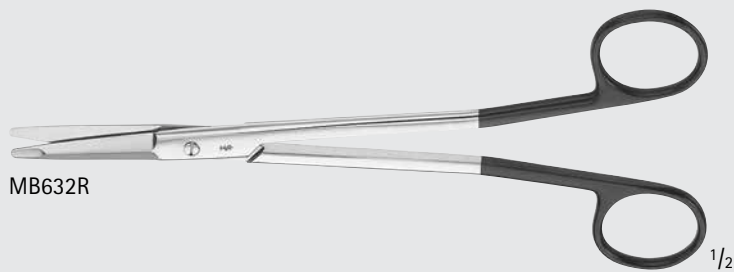

MB632R

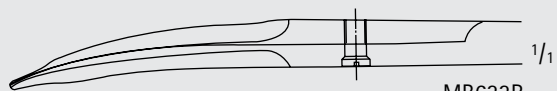

MB633R

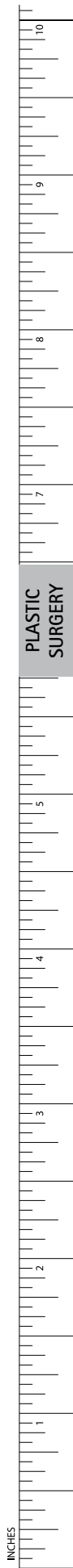

Plastic Surgery

DUROTIP™ TC Scissors

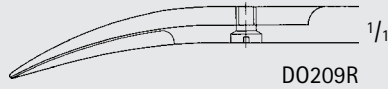
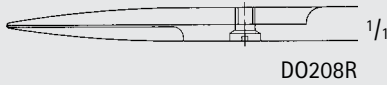
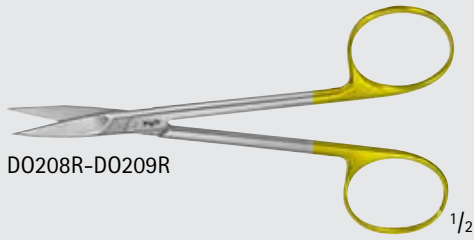

DUROTIP TC Delicate Scissors

Catalog Number	Tip	Blade	Length (in.)
DO208R	S/S	STR	4 3/4
DO209R	S/S	CVD	4 3/4

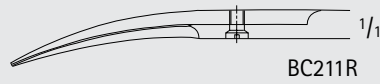
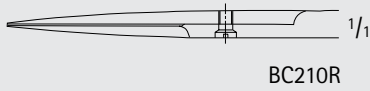

DUROTIP TC Iris Scissors, Delicate

Catalog Number	Tip	Blade	Length (in.)
BC210R	S/S	STR	4 1/4
BC211R	S/S	CVD	4 1/4

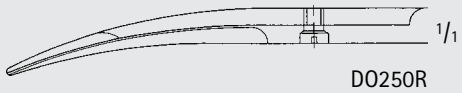
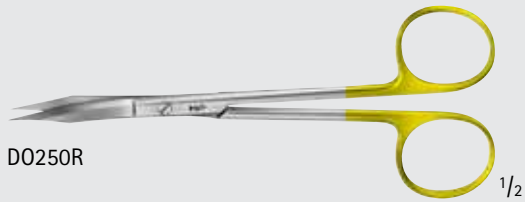

DUROTIP TC GOLDMAN-FOX Tenotomy Scissors, Delicate

Catalog Number	Tip	Blade	Length (in.)
DO250R	S/S	CVD, 1/SERR	5 1/8

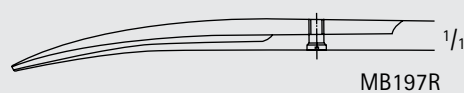
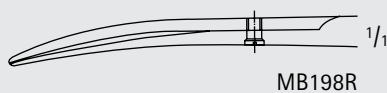

DUROTIP TC Par Scissors

Catalog Number	Tip	Length (in.)
MB198R	CVD, BLUNT	4 1/2
MB197R	CVD, BLUNT	5 3/4

PLASTIC SURGERY

DUROTIP TC GORNEY-FREEMAN
 Facelift Scissors

Catalog Number	Blade	Length (in.)
MB648R	STR, SERR	7 3/4
MB649R	CVD, SERR	7 3/4

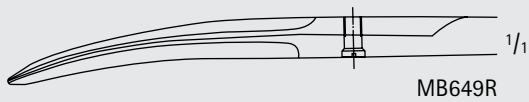
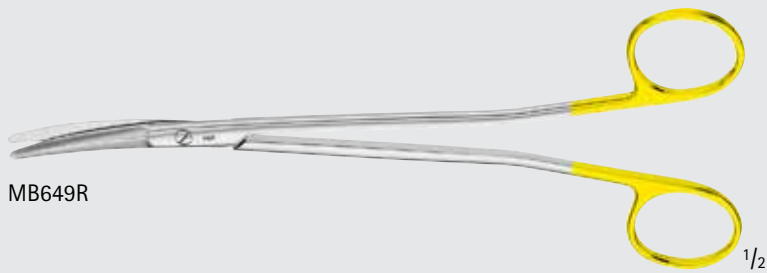
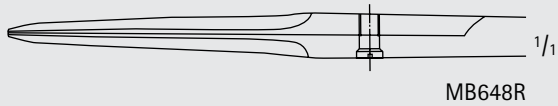
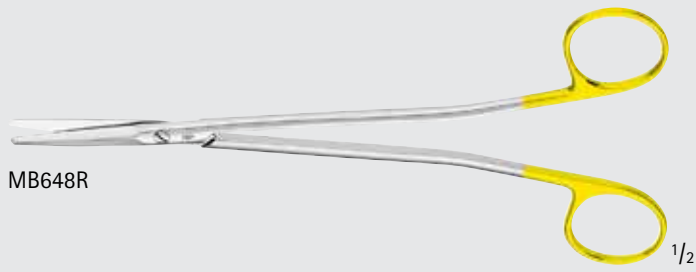

Wavecut

Wavecut scissors have one serrated cutting edge to help prevent tissue from slipping. The W after the item number indicates the scissors are the wavecut style, e.g. BC211W.

DUROTIP TC Iris Scissors, Wavecut

Catalog Number	Tip	Blade	Length (in.)
BC211W	S/S	CVD	4 1/4

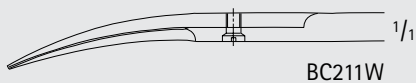
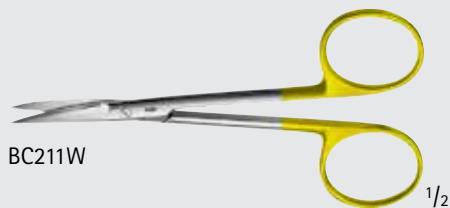

Plastic Surgery

DUROTIP™ TC Scissors



BC259W

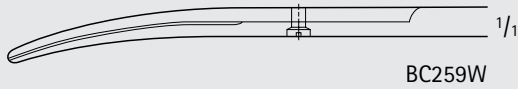

BC259W

DUROTIP TC Baby METZENBAUM Wavecut Dissecting Scissors, Delicate

Catalog Number	Tip	Blade	Length (in.)
BC259W	B/B	CVD	5 3/4

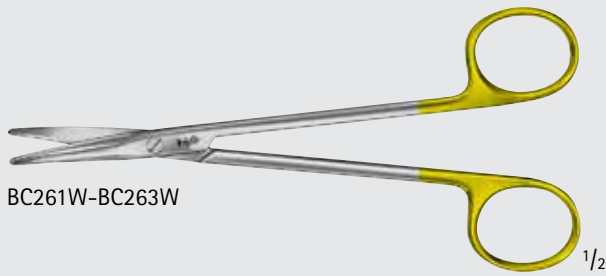

BC261W-BC263W

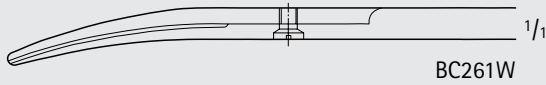

BC261W

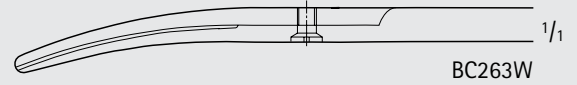

BC263W

DUROTIP TC METZENBAUM Wavecut Dissecting Scissors

Catalog Number	Tip	Blade	Length (in.)
BC261W	B/B	CVD	5 3/4
BC263W	B/B	CVD	7

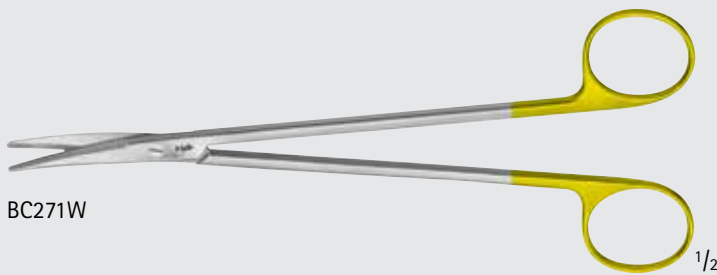

BC271W

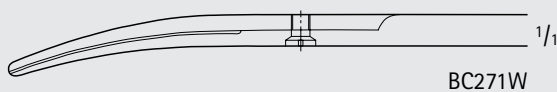

BC271W

DUROTIP TC METZENBAUM Wavecut Delicate Scissors

Catalog Number	Tip	Blade	Length (in.)
BC271W	B/B	CVD	7

PLASTIC SURGERY

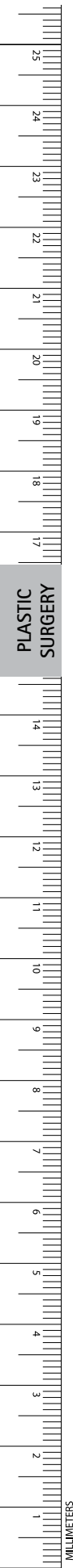



BC903R

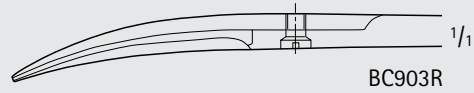

BC903R

SuperCut Scissors, Delicate

Catalog Number	Tip	Blade	Length (in.)
BC903R	S/S	CVD	5



BC909R



BC909R

GOLDMANN-FOX SuperCut Scissors,
Delicate

Catalog Number	Tip	Blade	Length (in.)
BC909R	S/S	CVD	5 1/8



Plastic Surgery

SuperCut Scissors

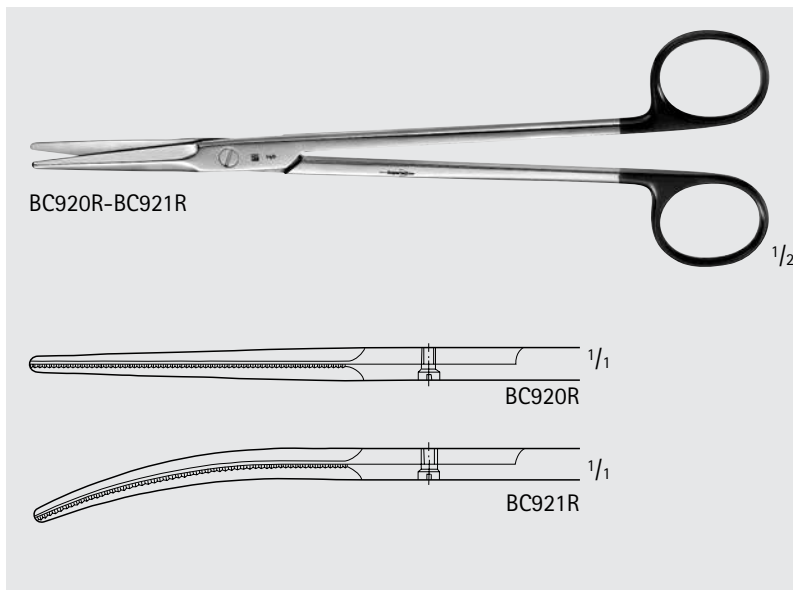
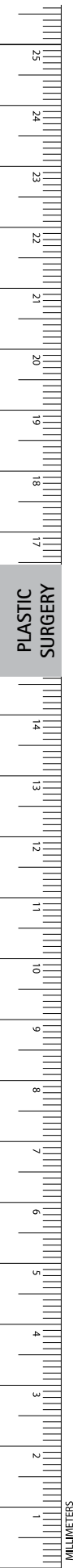

GORNEY SuperCut Scissors, Delicate

Catalog Number	Tip	Blade	Length (in.)
BC920R	B/B	STR	7 3/4
BC921R	B/B	CVD	7 3/4

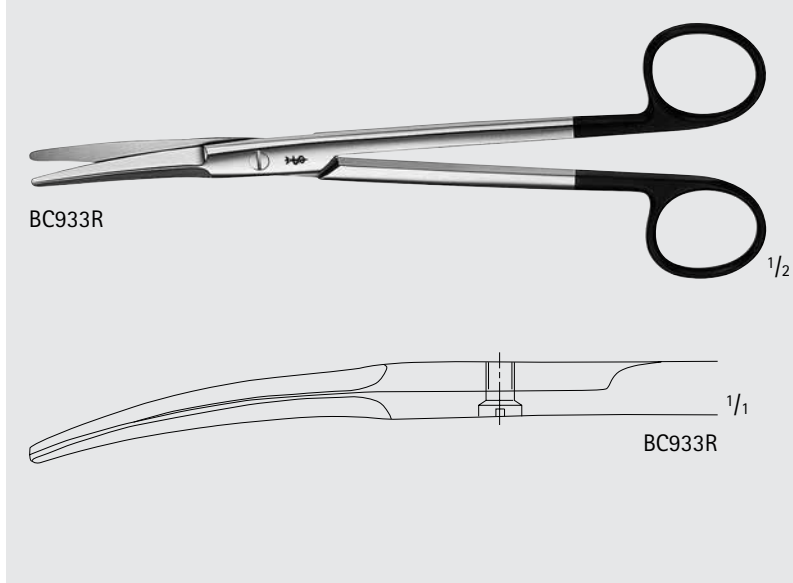

KAYE SuperCut Scissors, Delicate

Catalog Number	Blade	Length (in.)
BC933R	CVD	7 3/4

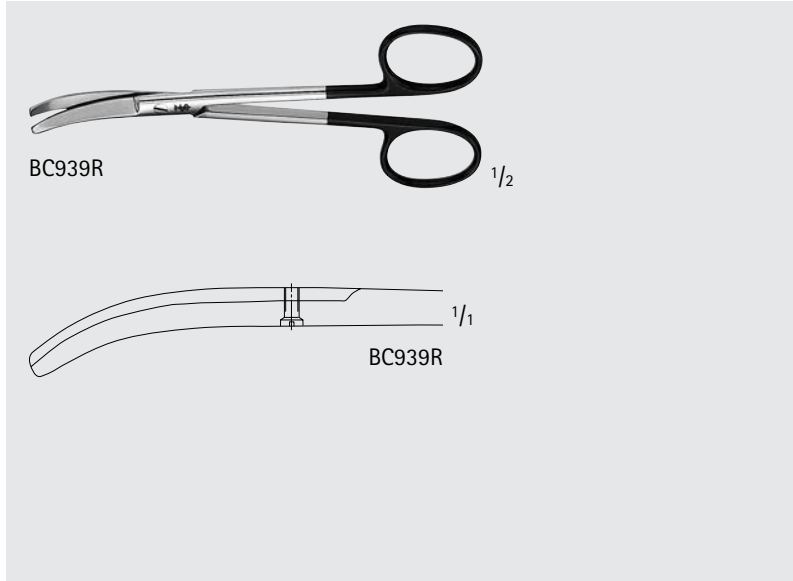

FOMON SuperCut Scissors

Catalog Number	Tip	Blade	Length (in.)
BC939R	B/B	CVD	4 1/2

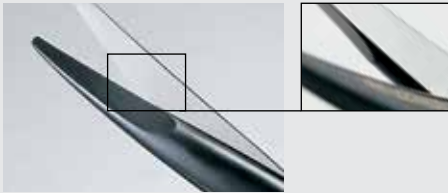

Microtome Edge

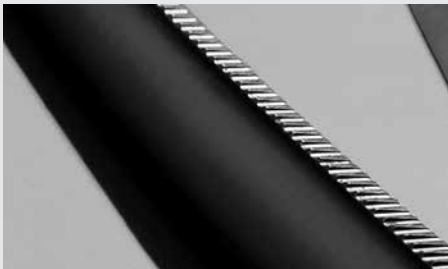

Wavecut

Noir Supreme Cut Scissors

- **Noir**
The combination of the renowned Aesculap Tungsten Carbide technology with the Aesculap Noir coating results in an extremely high surface hardness and therefore high wear resistance in daily hospital use.
- **Microtome edge**
The extremely sharp cutting edge of the scissors blade facilitates gentle cutting of tissue with minimal use of force.
- **Wavecut** helps prevent tissue from slipping out during the cutting process.
- The WB after the item number indicates the Noir scissors are the wavecut style, e.g. BC211WB.

For more information see our brochure number DOC637.



Noir Iris Dissecting Scissors

Catalog Number	Tip	Blade	Length (in.)
BC210B	S/S	STR	4 1/4
BC211B	S/S	CVD	4 1/4
BC211WB	S/S	CVD	4 1/4



Noir Strabismus Dissecting Scissors

Catalog Number	Tip	Blade	Length (in.)
BC257B	B/B	CVD	4 1/2
BC257WB	B/B	CVD	4 1/2



Noir Baby METZENBAUM Dissecting Scissors

Catalog Number	Tip	Blade	Length (in.)
BC259B	B/B	CVD	5 3/4
BC259WB	B/B	CVD	5 3/4



Plastic Surgery

Noir™ Supreme Cut Scissors

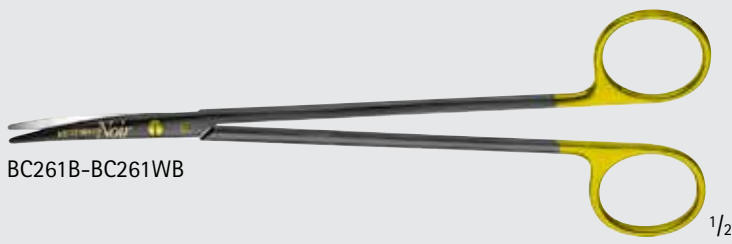

Noir METZENBAUM Dissecting Scissors

Catalog Number	Tip	Blade	Length (in.)
BC261B	B/B	CVD	5 3/4
BC261WB	B/B	CVD	5 3/4

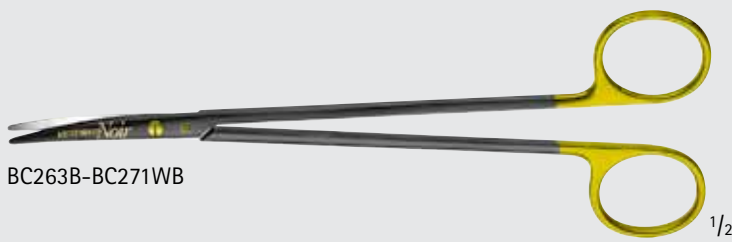

Noir METZENBAUM Dissecting Scissors

Catalog Number	Tip	Blade	Length (in.)
BC263B	B/B	CVD	7
BC263WB	B/B	CVD	7
BC271B	B/B	CVD, DEL	7
BC271WB	B/B	CVD, DEL	7



Noir TOENNIS-ADSON Dissecting Scissors

Catalog Number	Tip	Blade	Length (in.)
BC273B	B/B	CVD, DEL	6 7/8
BC273WB	B/B	CVD, DEL	6 7/8

PLASTIC SURGERY



MUELLER Micro Scissors

Catalog Number	Tip	Handle Color	Blade	Length (in.)
FM010R	S/S	BLUE	STR	4 3/4
FM040R	S/S	BLUE	STR	6 3/4
FM011R	S/S	BLUE	CVD	4 3/4
FM012R	S/B	BLUE	CVD	4 3/4
FM013R	B/B	BLUE	CVD	4 3/4
FM014R	S/BALL-PT	BLUE	CVD	4 3/4
FM041R	S/S	BLUE	CVD	6 3/4



FM010R-FM040R

1/2



1/1



1/1

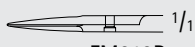

FM010R

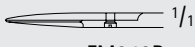

FM040R



FM011R-FM041R

1/2



1/1



1/1



1/1



1/1



1/1



FM011R

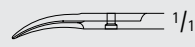

FM012R

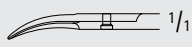

FM013R

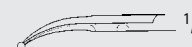

FM014R

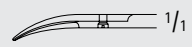

FM041R



FD251R-FD252R

1/2

Micro Scissors, Golf Ball Handle

Catalog Number	Blade	Length (in.)
FD252R	SLIGHT CVD, 1/SERR	7
FD251R	CVD	7



1/1

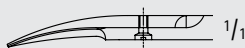

FD252R



1/1

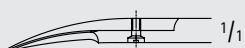

FD251R



PLASTIC SURGERY

INCHES

Plastic Surgery

Micro Scissors and Needle Holders

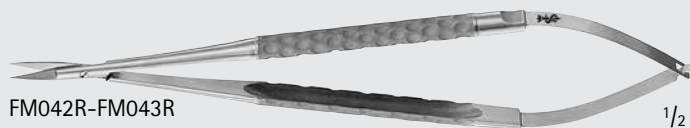

Micro Scissors, Golf Ball Handle

Catalog Number	Blade	Length (in.)
FM042R	STR	7
FM043R	CVD	7

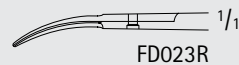
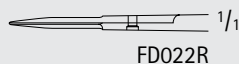
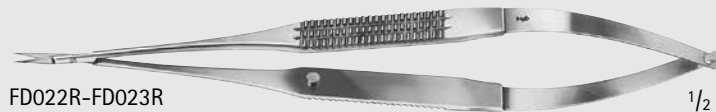

YASARGIL Micro Vessel Scissors

Catalog Number	Blade	Handle	Length (in.)
FD022R	STR	FLAT, SERR	7 1/4
FD023R	CVD	FLAT, SERR	7 1/4

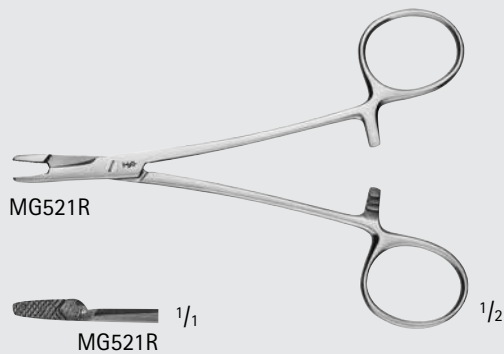

HEGAR-OLSEN Needle Holder

Catalog Number	Tip	Length (in.)
MG521R	SERR	4 3/4

PLASTIC SURGERY

MILLIMETERS

Plastic Surgery

DUROGRIP™ TC Needle Holders

Aesculap features Needle Holders with Tungsten Carbide (TC) inserts. A smooth jaw and three different serration patterns are available, depending on the size of the suture needle.

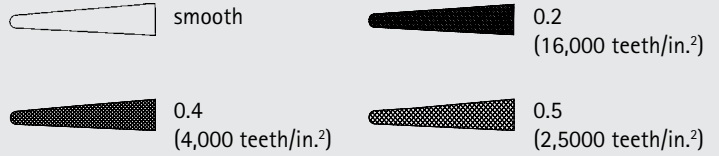
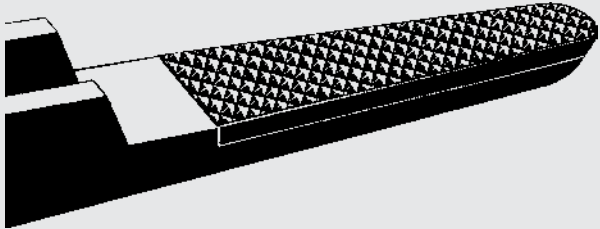

We recommend carbide inserts as follows:

Jaw Surface	Suture Material
Smooth	9/0 - 11/0
0.2 mm pitch of serration	6/0 - 10/0
0.4 mm pitch of serration	4/0 - 6/0
0.5 mm pitch of serration	up to 3/0



BM001R

1/2

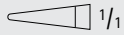

1/1

BM001R



BM002R

1/2



1/1 0.2

BM002R



BM004R

1/2

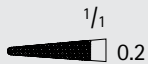

1/1 0.2

BM004R



BM005R

1/2

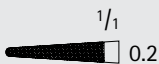

1/1 0.2

BM005R

DUROGRIP TC CASTROVIEJO Micro Needle Holder, Flat Handle

Catalog Number	Jaw	Length (in.)
BM001R	SMOOTH	5 3/4
BM002R	SERR	5 3/4
BM004R	SERR	7
BM005R	SERR	8 1/2

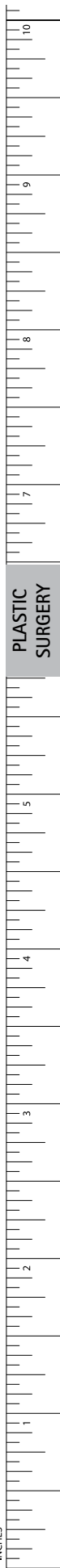

PLASTIC SURGERY

INCHES

Plastic Surgery

DUROGRIP™ TC Needle Holders

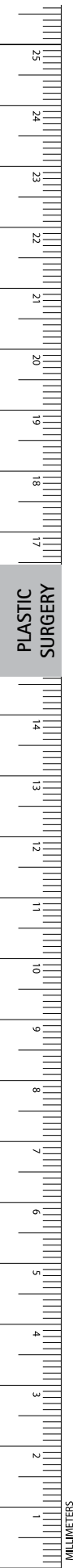

BM127R

1/2

1/1

BM127R

**DUROGRIP TC LEWIN Needle Holder/
Scissors**

Catalog Number	Jaw	Length (in.)
BM127R	SMOOTH	5

MG005R-MG006R, BM124R, BM128R

1/1

MG005R

1/1

MG006R

1/1

0.4

BM124R

1/1

0.4

BM128R

**DUROGRIP TC HEGAR-OLSON
Needle Holder/Scissors**

Catalog Number	Jaw	Length (in.)
MG005R	SMOOTH	4 3/4
MG006R	SERR	4 3/4
BM128R	SERR	5 3/4
BM124R	SERR	6 1/2

Plastic Surgery

DUROGRIP™ TC Needle Holders

DUROGRIP TC GILLIES Needle Holder/ Scissors

Catalog Number	Jaw	Handle	Length (in.)
BM129R	SERR	OFF-SET	6 1/4

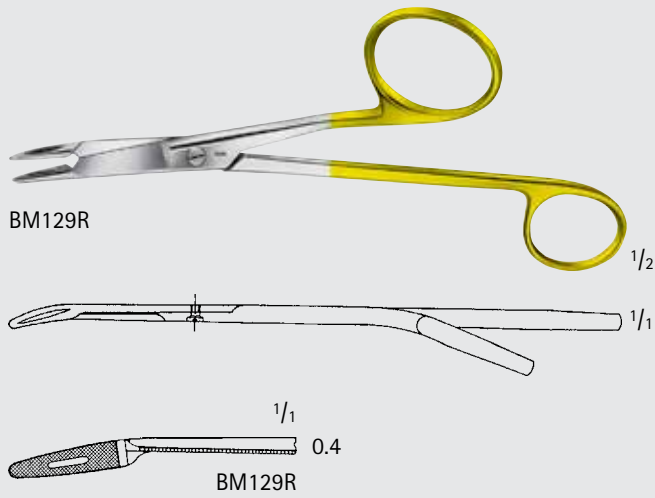

DUROGRIP TC CRILE-WOOD Needle Holder

Catalog Number	Jaw	Length (in.)
BM016R	SERR	5 3/4
BM017R	SERR	7 1/4
BM019R	SERR	7 7/8
BM030R	SERR	10 5/8
BM021R	SERR	12

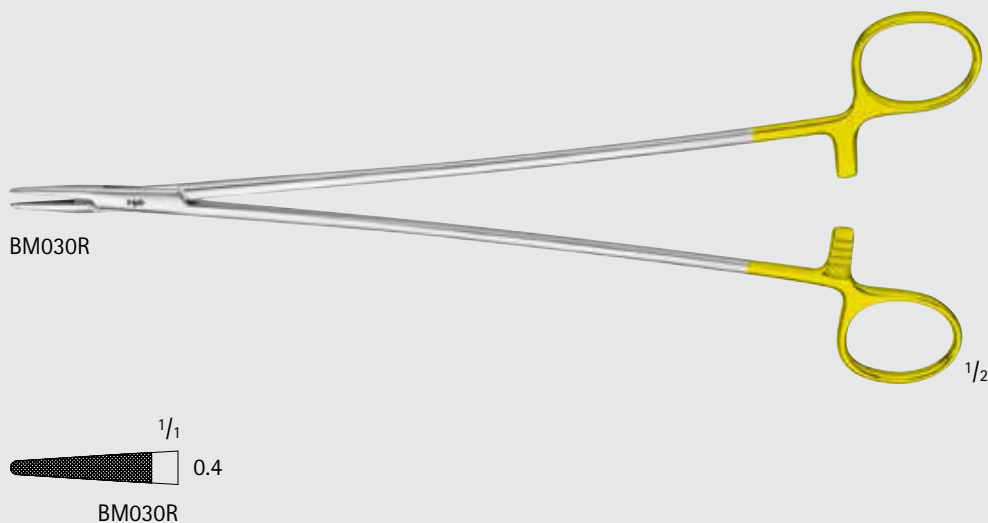
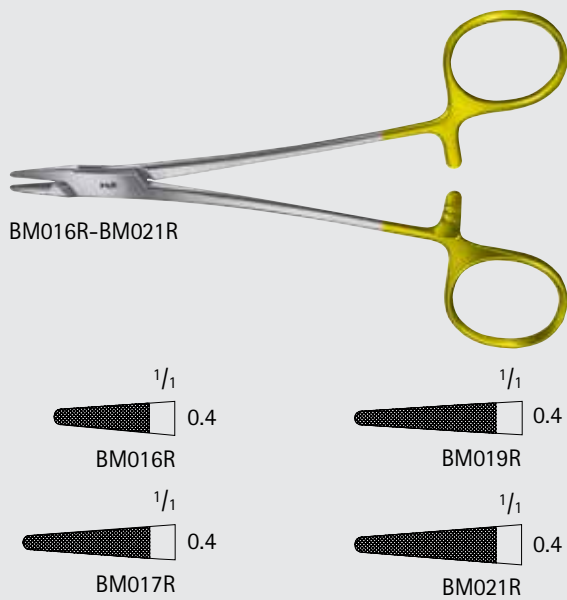

Plastic Surgery

DUROGRIP™ TC Needle Holders

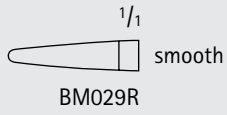
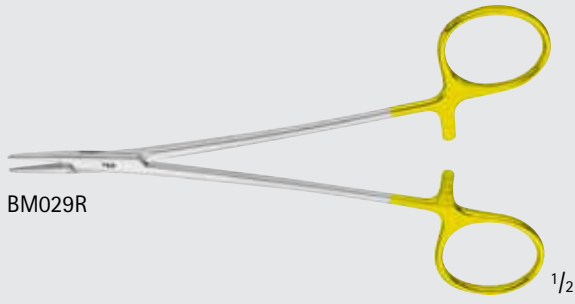

DUROGRIP TC CRILE-WOOD Needle Holder

Catalog Number	Jaw	Length (in.)
BM029R	SMOOTH	6

PLASTIC
SURGERY





MB295R



MB295R

CASTROVIEJO Suture Forceps

Catalog Number	Tip Size (mm)	Teeth	Length (in.)
MB295R	0.12	1 x 2	4 1/8



MB294R



MB294R

CASTROVIEJO COLIBRI Type Corneal Forceps

Catalog Number	Tip Size (mm)	Teeth	Length (in.)
MB294R	0.12	1 x 2	4 1/8



BD505R



BD505R

BONN Eye Forceps, W/ Platform

Catalog Number	Tip Size (mm)	Teeth	Length (in.)
BD505R	0.2	1 x 2	3 3/4



BD329R



BD329R

Jewelers Forceps

Catalog Number	Tip Size (mm)	Tip	Length (in.)
BD329R	0.3	ANG	4 1/4



BD330R



BD330R

Micro Forceps #4 Jewelers

Catalog Number	Tip Size (mm)	Length (in.)
BD330R	0.2	4 1/4

Plastic Surgery

Dressing and Tissue Forceps



BD345R



BD345R

Micro Jeweler's Forceps

Catalog Number	Tip Size (mm)	Teeth	Length (in.)
BD345R	0.4	1 x 2	5 1/4



BD336R



BD336R

WISE Micro Suture Forceps

Catalog Number	Tip Size (mm)	Tip	Length (in.)
BD336R	0.3	STR	5 1/4
BD337R	0.3	CVD	5 1/4



BD337R



BD337R



BD338R



BD338R

Micro Suture Forceps, W/ Platform

Catalog Number	Tip Size (mm)	Length (in.)
BD338R	0.3	4 3/4



BD340R



BD340R

AUSTIN Micro Suture Forceps, W/ Platform

Catalog Number	Tip Size (mm)	Length (in.)
BD340R	0.8	5 1/2

PLASTIC SURGERY





FD284R-FD287R

Micro Suture Forceps, Round Handle

Catalog Number	Tip Size (mm)	Tip	Length (in.)
FD284R	0.3	STR	6
FD286R	0.5	STR	7
FD285R	0.3	CVD	6
FD287R	0.5	CVD	7

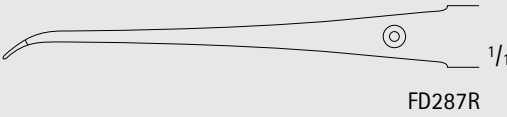
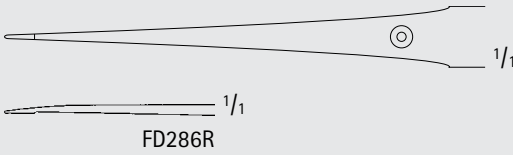
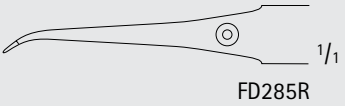
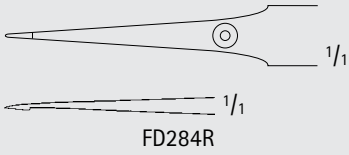

BD509R

MICRO-ADSON-BIEMER Forceps

Catalog Number	Teeth	Length (in.)
BD509R	1 x 2	4 3/4

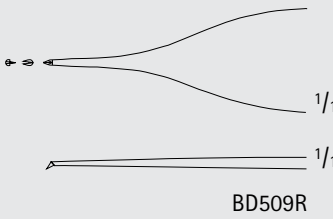

PLASTIC SURGERY

INCHES

Plastic Surgery

Dressing and Tissue Forceps



FM001R-FM006R

MUELLER Micro Forceps

Catalog Number	Tip Size (mm)	Handle Color	Teeth	Length (in.)
FM001R	0.15	BROWN	-	4 1/4
FM002R	0.20	BROWN	-	4 1/4
FM003R	0.30	BROWN	-	4 1/4
FM004R	0.50	BLACK	1 x 2	4 1/4
FM005R	1.20	GREY	RING	4 1/4
FM006R	1.20	GREY	TRI	4 1/4

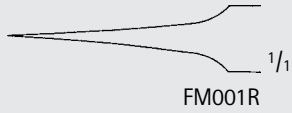

FM001R

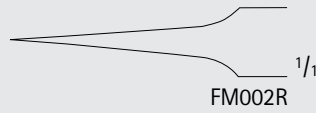

FM002R

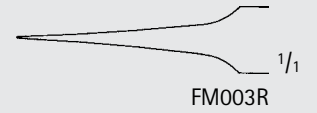

FM003R



FM004R

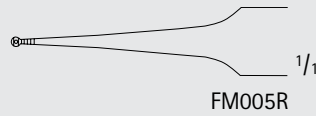

FM005R

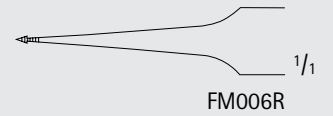

FM006R



BD260R

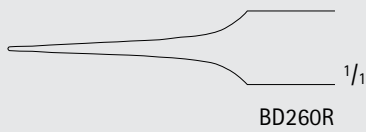

BD260R



BD261R

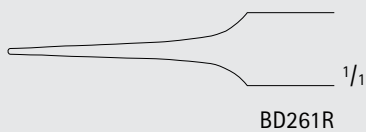

BD261R

LAZAR Micro Suture Forceps

Catalog Number	Tip Size (mm)	Length (in.)
BD260R	0.5	6 1/8
BD261R	0.8	6 1/8

PLASTIC SURGERY

Plastic Surgery

Bone and Tendon Forceps

HERZ Tendon Seizing Forceps

Catalog Number	Jaw	Length (in.)
BF303R	CVD	6 1/8

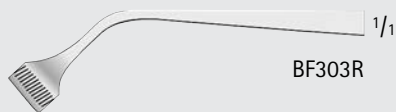
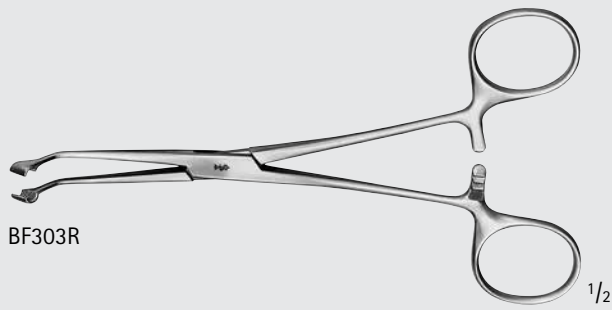

JACKSON Tendon Seizing Forceps

Catalog Number	Teeth	Length (in.)
BF306R	4 x 5	6 1/8

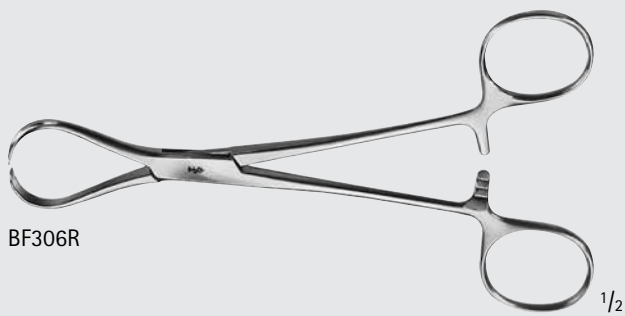

BUNNELL Tendon Passing Probe

Catalog Number	Length (in.)
MB363C	7 3/8
FO940R	9



PLASTIC SURGERY

Plastic Surgery

Bone and Tendon Forceps

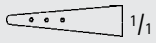
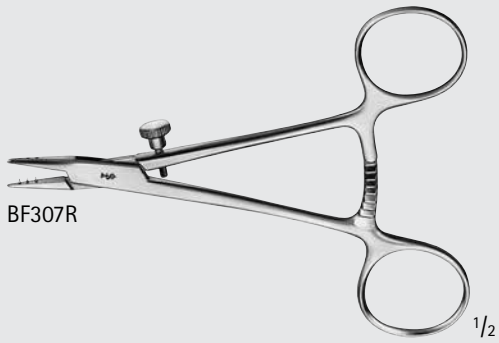

Tendon Seizing Forceps, W/ 3 Pins

Catalog Number	Length (in.)
BF307R	4 3/4

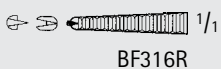
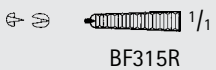
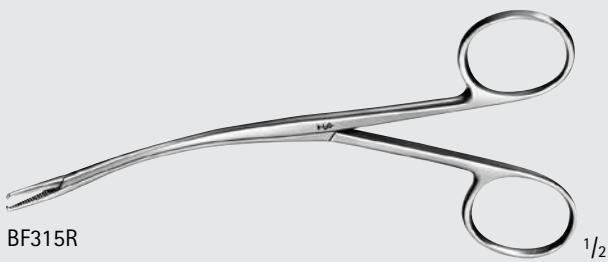
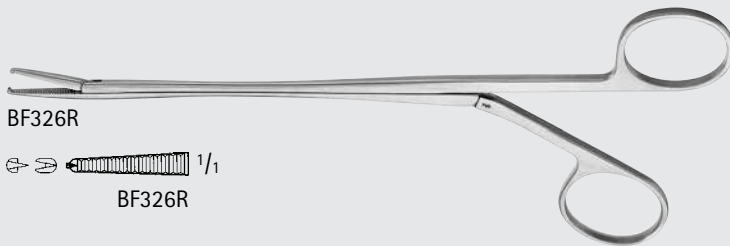
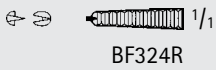
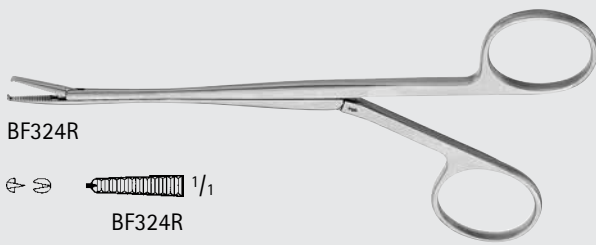

BRAND Tendon Holding Forceps

Catalog Number	Jaw	Teeth	Length (in.)
BF324R	STR	1 x 2	6
BF326R	STR	1 x 2	7 1/4
BF315R	CVD	1 x 2	6
BF316R	CVD	1 x 2	7 1/4



KLEINERT-KUTZ Tendon Retriever

Catalog Number	Size	Shaft	Length (in.)
MG091R	-	FLEXIBLE	8
MB985R	SMALL	RIGID	8 1/4

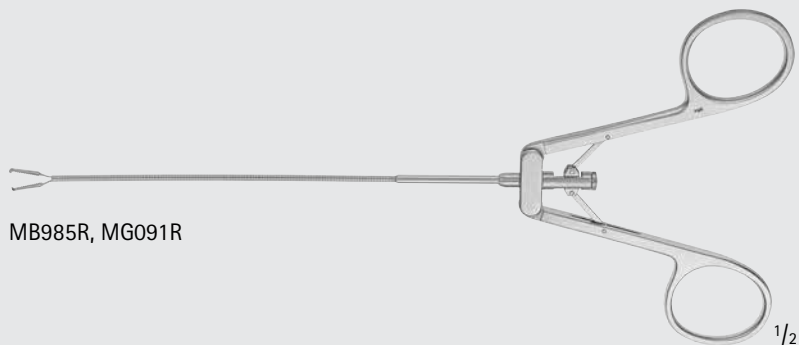

MB985R, MG091R



MG091R

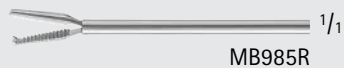

MB985R

CARROLL Tendon Pulling Forceps

Catalog Number	Length (in.)
MB474R	6



MB474R

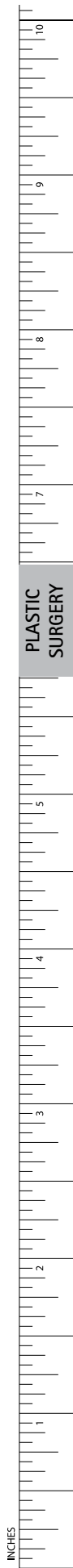

INCHES

Plastic Surgery

Bone and Tendon Forceps

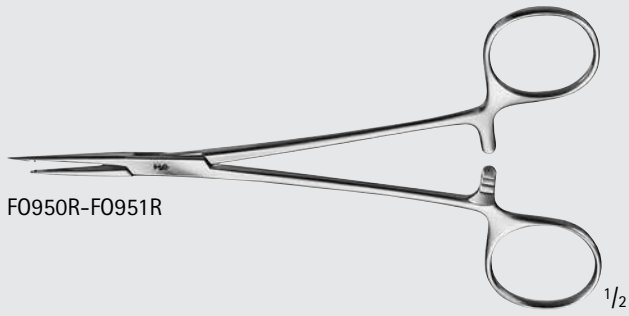

F0950R-F0951R

Tendon Interlacing Forceps

Catalog Number	Jaw	Length (in.)
F0950R	STR	6
F0951R	CVD	6

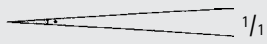

1/1



1/1



1/1

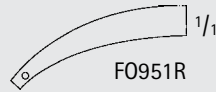

F0951R 1/1

F0950R

Tendon Stripper

Catalog Number	Length (in.)
F0935R	11 3/4
F0939R	19 3/4



F0935R-F0939R

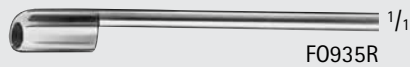

F0935R 1/1



1/1

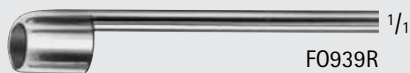

F0939R 1/1



1/1

PLASTIC SURGERY



BD952R



BD952R

Splinter Forceps

Catalog Number	Length (in.)
BD952R	3 1/8



BD963R-BD965R



BD963R



BD964R



BD965R

FEILCHENFELD Splinter Forceps

Catalog Number	Length (in.)
BD963R	3
BD964R	3 3/4
BD965R	4 1/2

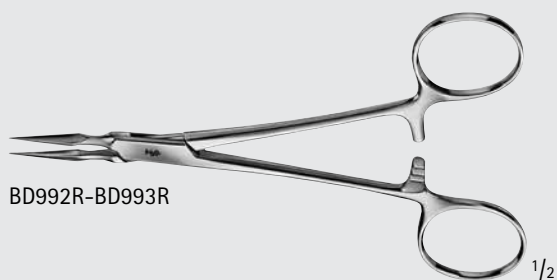

BD992R-BD993R



BD992R

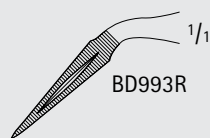

BD993R

STIEGLITZ Splinter Forceps

Catalog Number	Jaw	Length (in.)
BD992R	STR	5 1/2
BD993R	CVD	5 1/2

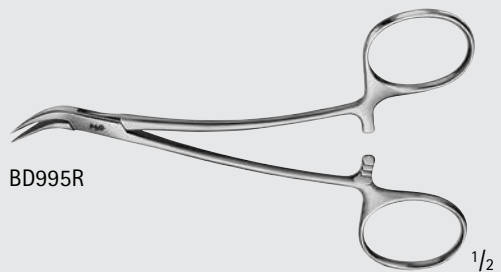

BD995R

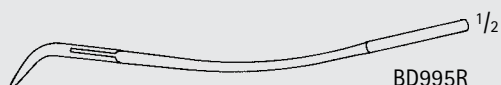

BD995R



PEET Splinter Forceps

Catalog Number	Length (in.)
BD995R	4 3/4

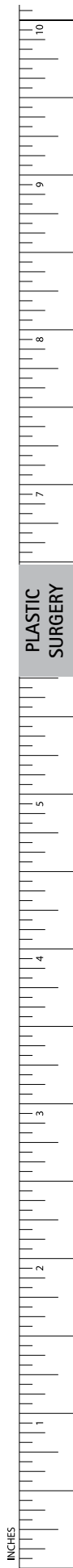

PLASTIC SURGERY

INCHES

Plastic Surgery

Hemostatic Forceps



CARREL Artery Forceps

Catalog Number	Length (in.)
BH100R	3 1/4

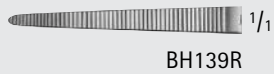

DANDY Forceps

Catalog Number	Jaw	Jaw Shape	Length (in.)
BH139R	SERR	CVD	5 1/2
BH143R	1 x 2 Teeth	LAT-CVD	5 1/2



OA332R-OA333R



OA332R



OA333R

GRAEFE Hook

Catalog Number	Tip	Length (in.)
OA332R	SHARP	5
OA333R	BLUNT	5



OA334R-OA335R

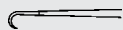

OA334R



OA335R

GUTHRIE Double Hook

Catalog Number	Tip	Length (in.)
OA334R	SHARP	5
OA335R	SHARP	5 1/8



OA336R-OA338R

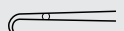

OA336R



OA337R



OA338R

ROLLET Hook Retractor

Catalog Number	Tip	Blade End	Length (in.)
OA336R	SHARP	2 PRONG	5 1/8
OA337R	SHARP	4 PRONG	5 1/4
OA338R	BLUNT	4 PRONG	5 1/4



OA340R

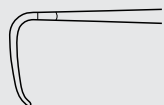

OA340R

PAUL Tendon Hook

Catalog Number	Tip	Blade End	Tip Size (mm)	Length (in.)
OA340R	BLUNT	3 PRONGS	11 x 8	4 3/4



OA351R



OA351R

JAEGER Hook Retractor, Fine

Catalog Number	Tip	Length (in.)
OA351R	SHARP	5 1/4

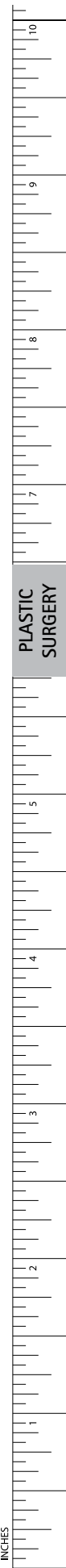

PLASTIC SURGERY

INCHES

Plastic Surgery

Hooks and Retractors



OL601R-OL603R

KLEINERT-KUTZ Skin Hook

Catalog Number	Size	Tip	Tip Size (mm)	Length (in.)
OL601R	1	SHARP	2.5	6 1/4
OL602R	2	SHARP	4.2	6 1/4
OL603R	3	SHARP	4.8	6 1/4

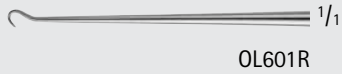

OL601R

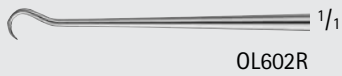

OL602R

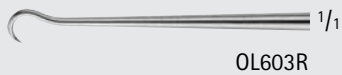

OL603R



OL610R

KILNER Skin Hook

Catalog Number	Tip	Length (in.)
OL610R	SHARP	6 1/4



OL610R



OL611R-OL612R

GILLIES Skin Hook

Catalog Number	Hook End	Tip	Length (in.)
OL611R	SMALL	SHARP	7
OL612R	LARGE	SHARP	7



OL611R

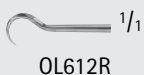

OL612R



OL619R

COTTLE Hook

Catalog Number	Tip	Length (in.)
OL619R	CVD, SHARP	6 1/4
OL617R	ANG, SHARP	6 1/4



OL619R



OL617R

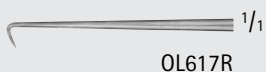

OL617R

PLASTIC SURGERY

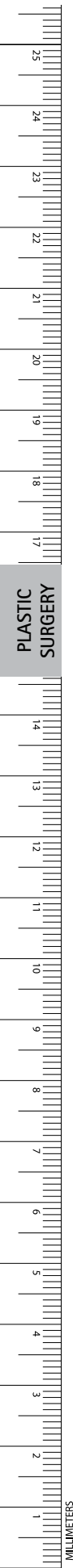



OL620R, MA185R, OL622R-OL624R, MD581

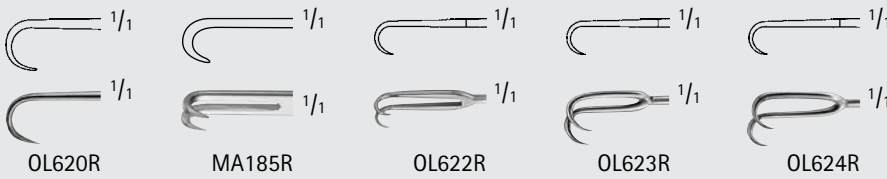

JOSEPH Skin Hook

Catalog Number	Tip	Prongs	Tip Size (mm)	Length (in.)
OL620R	SHARP	1	-	6 1/2
MA185R	SHARP	2	2	6 1/4
OL622R	SHARP	2	3	6 1/2
OL623R	SHARP	2	6	6 1/2
OL624R	SHARP	2	8	6 1/2
MD581	SHARP	2	10	6 1/2



MG370R



COTTLE-JOSEPH Double Hook

Catalog Number	Tip Size (mm)	Length (in.)
MG370R	12	5 3/4



OL621R

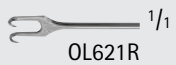
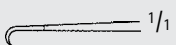

FREER Double Hook

Catalog Number	Length (in.)
OL621R	6



OA357R-OA359R

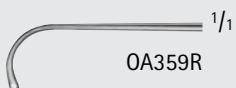
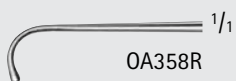
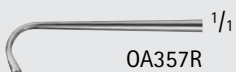

GRAEFE Strabismus Nerve/Vessel Hook

Catalog Number	Tip	Length (in.)
OA357R	SMALL	5 1/2
OA358R	MEDIUM	5 1/2
OA359R	LARGE	5 1/2



Plastic Surgery

Hooks and Retractors

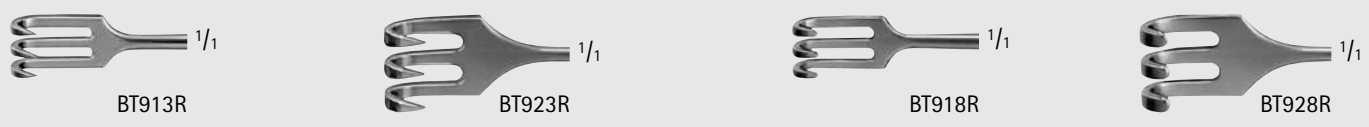
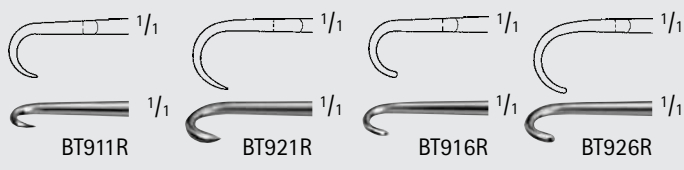
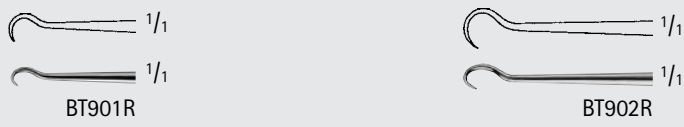

MANNERFELT Retractor

Catalog Number	Prongs	Tip	Blade Shape	Blade Size (mm)	Length (in.)
BT901R	1	SHARP	HOOK CVD	-	5 1/4
BT902R	1	SHARP	HOOK CVD	-	6 1/8
BT911R	1	SHARP	SMALL CVD	SMALL PRONG	6 1/8
BT921R	1	SHARP	SMALL CVD	LARGE PRONG	6 1/8
BT916R	1	BLUNT	SMALL CVD	SMALL PRONG	6 1/8
BT926R	1	BLUNT	SMALL CVD	LAGRGE PRONG	6 1/8
BT904R	2	SHARP	SMALL CVD	3.5 x 12	6 1/8
BT912R	2	SHARP	SMALL CVD	5 x 4	6 1/8
BT922R	2	SHARP	SMALL CVD	8 x 8	6 1/8
BT917R	2	BLUNT	SMALL CVD	5.5 x 4	6 1/8
BT927R	2	BLUNT	SMALL CVD	7 x 8	6 1/8
BT906R	2	SHORT	ANG	8 x 12.5	6 1/8
BT913R	3	SHARP	SMALL CVD	5.5 x 7.2	6 1/8
BT923R	3	SHARP	SMALL CVD	7 x 11	6 1/8
BT918R	3	BLUNT	SMALL CVD	5.5 x 7.2	6 1/8
BT928R	3	BLUNT	SMALL CVD	7 x 11	6 1/8

PLASTIC SURGERY





BT943R-BT946R

LANGENBECK-MANNERFELT Retractor

Catalog Number	Blade Size (mm)	Length (in.)
BT943R	15 x 6	6 1/8
BT944R	20 x 6	6 1/8
BT945R	25 x 6	6 1/8
BT946R	30 x 8	6 1/8

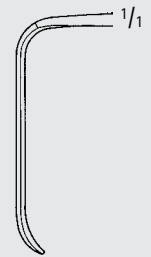
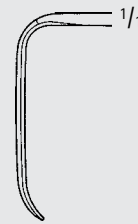
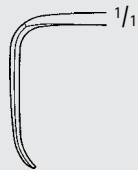

BT943R



BT944R



BT945R



BT946R



BT948R-BT958R

MANNERFELT Saddle Hook

Catalog Number	Tip Size (mm)	Length (in.)
BT940R	16 x 16	6 1/8
BT948R	12 x 12	6 1/8
BT949R	12 x 14	6 1/8
BT951R	14 x 16	6 1/8
BT958R	12 x 12 FEN	6 1/8

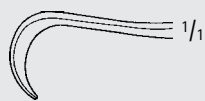
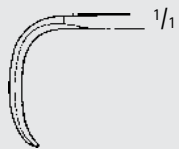

BT940R



BT948R



BT949R



BT951R

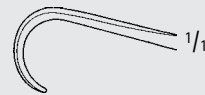

BT958R



BT964R

MANNERFELT Tendon Double Hook

Catalog Number	Length (in.)
BT964R	6 1/4



BT964R



Plastic Surgery

Hooks and Retractors



BT966R

1/2



1/1



1/1

BT966R

MANNERFELT Double Spatula

Catalog Number	Length (in.)
BT966R	6 1/4



MB727R-MB733R

1/2

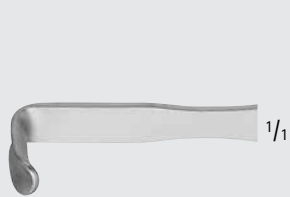

1/1



1/1

MB727R-MB733R

CRILE Retractor

Catalog Number	Size	Blade Size (mm)	Length (in.)
MB727R	1	3 x 11 / 6 x 21	4 1/4
MB728R	2	6 x 13 / 10 x 21	6 1/8
MB729R	3	16 x 25 / 17 x 35	6 1/4
MB730R	4	22 x 29 / 29 x 44	7
MB731R	5	29 x 41 / 35 x 51	7
MB732R	6	32 x 64 / 35 x 70	7 7/8
MB733R	7	41 x 76 / 51 x 79	8 7/8



MB384R

1/2

TEBBETTS Breast Spatula, Semi-Malleable

Catalog Number	Length (in.)
MB384R	12 1/2

PLASTIC SURGERY

TEBBETTS Breast Retractor

Catalog Number	Blade	Length (in.)
MB647R	DBL-ENDED	12



MB647R

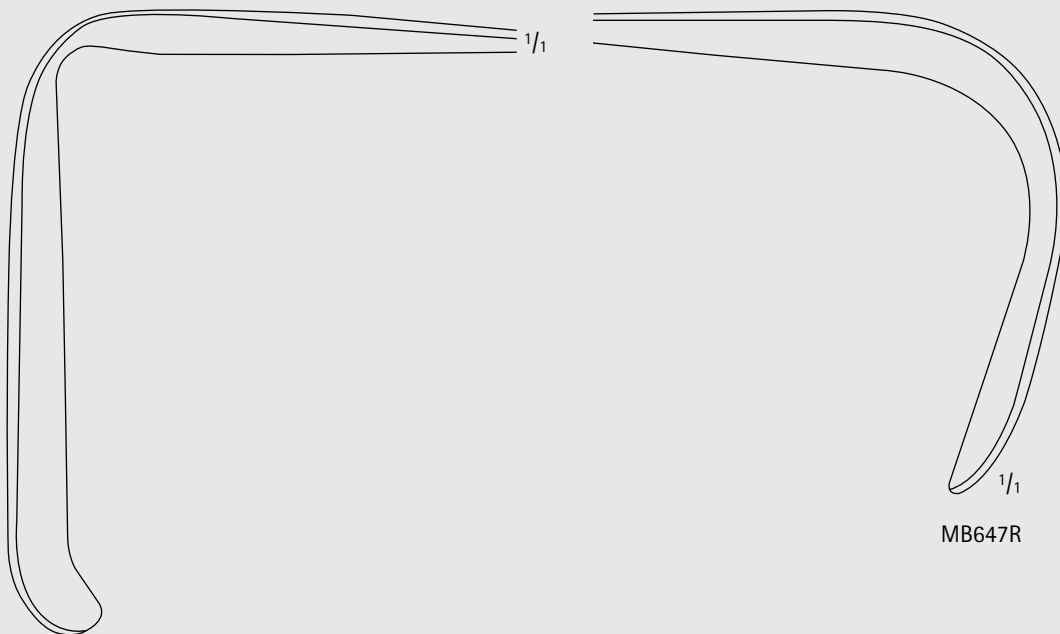

MB647R



MB934R

FREEMAN Facelift Retractor

Catalog Number	Length (in.)
MB934R	7

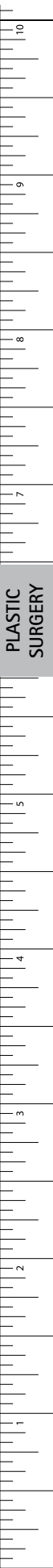

INCHES

Plastic Surgery

Hooks and Retractors



OL211R



OL211R



OL212R



OL212R

COTTLE Alar (MASING) Retractor

Catalog Number	Blade Size (mm)	Length (in.)
OL211R	6 x 12	5 1/2
OL212R	10 x 12	5 1/2



OA310R-OA314R



OA310R



OA311R

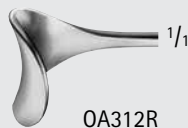

OA312R



OA313R



OA314R

DESMARRES Lid Retractor

Catalog Number	Blade Size (mm)	Length (in.)
OA310R	9 x 9	5 1/2
OA311R	9 x 12	5 1/2
OA312R	11 x 14	5 1/2
OA313R	12 x 16	5 1/2
OA314R	13 x 18	5 1/2

PLASTIC SURGERY

MILLIMETERS



BV001R

1/2

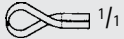

BV001R

1/1

FINSEN Retractor

Catalog Number	Tip	Blade End	Length (in.)
BV001R	SHARP	2 x 3 PRONGS	2

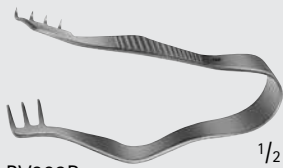

BV002R

1/2

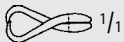

BV002R

1/1

FINSEN Retractor

Catalog Number	Tip	Blade End	Length (in.)
BV002R	SHARP	3 x 4 PRONGS	2 3/4



BV003R

1/2

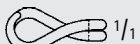

BV003R

1/1

FINSEN Modified Retractor

Catalog Number	Tip	Blade End	Length (in.)
BV003R	BLUNT	2 x 3 PRONGS	3



BV005R

1/2



BV005R

1/1

FINSEN Retractor

Catalog Number	Tip	Blade End	Length (in.)
BV005R	SHARP	3 x 4 PRONGS	2 3/4



BV008R, BV015R

1/2



BV015R

1/1



BV008R

1/1

HEISS Self-Retaining Retractor

Catalog Number	Tip	Prongs	Length (in.)
BV015R	SHARP	4 x 4	4
BV008R	BLUNT	4 x 4	4



PLASTIC SURGERY

INCHES

Plastic Surgery

Hooks and Retractors



BV006R-BV007R



BV006R

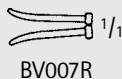

BV007R

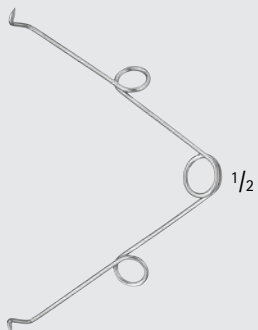

MD471

Spring Wire Retractor

Catalog Number	Tip	Prongs	Length (in.)
BV006R	BLUNT	3 x 3	1 3/4
BV007R	BLUNT	3 x 3	2 1/4
MD471	SHARP	1 x 1	3

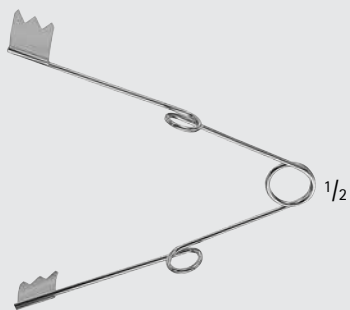

MB194R-MB195R

Spring Wire Retractor

Catalog Number	Length (in.)
MB194R	3 1/2
MB195R	4 1/2

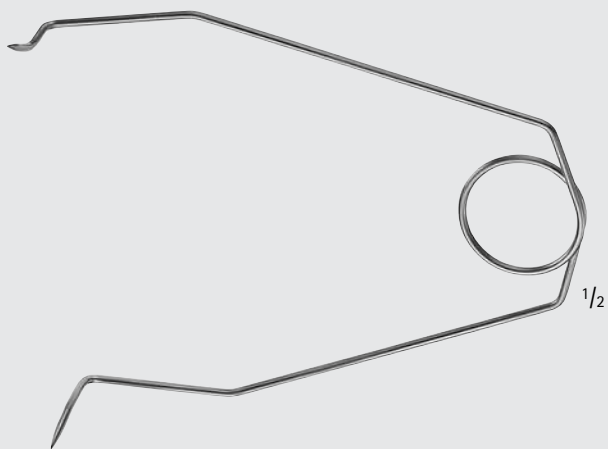

MB777R-MB196R

Spring Wire Retractor

Catalog Number	Size	Length (in.)
MB777R	SMALL	5
MB778R	MEDIUM	5 1/8
MB196R	LARGE	9

PLASTIC SURGERY



BV010R-BV011R

ALM Retractor

Catalog Number	Tip	Prongs	Length (in.)
BV010R	SHARP	4 x 4	2 3/4
BV011R	SHARP	4 x 4	4



BV010R



BV011R



BV028R

ALLPORT Retractor

Catalog Number	Tip	Prongs	Length (in.)
BV028R	SHARP	4 x 4	3 3/4



BV028R

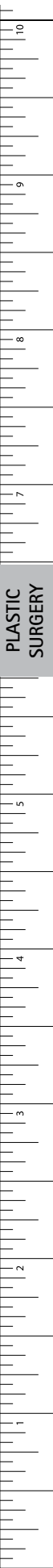

PLASTIC SURGERY

INCHES

Plastic Surgery

Aluminum Hand

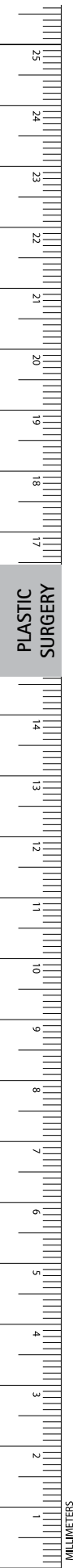

27.5 cm

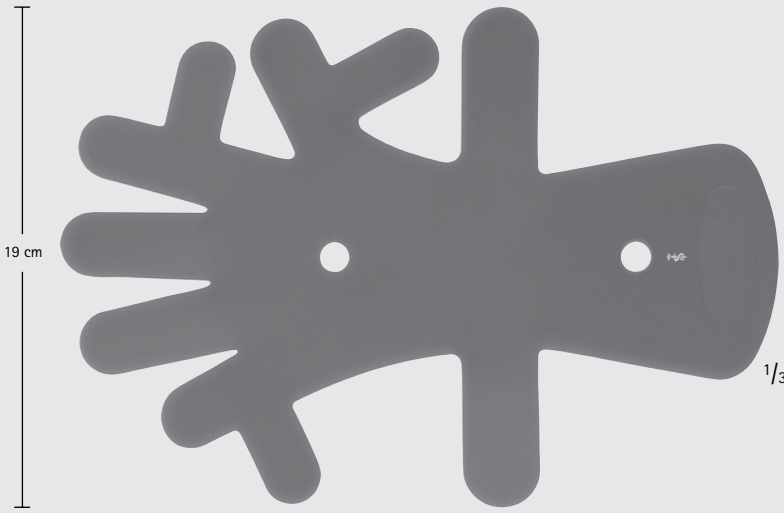

F0917A

Aluminum Hand, Blue Silicone Coated

Catalog Number	Size (in.)
F0917A	10 3/4 x 7 1/2
F0918A	16 1/8 x 11

41 cm

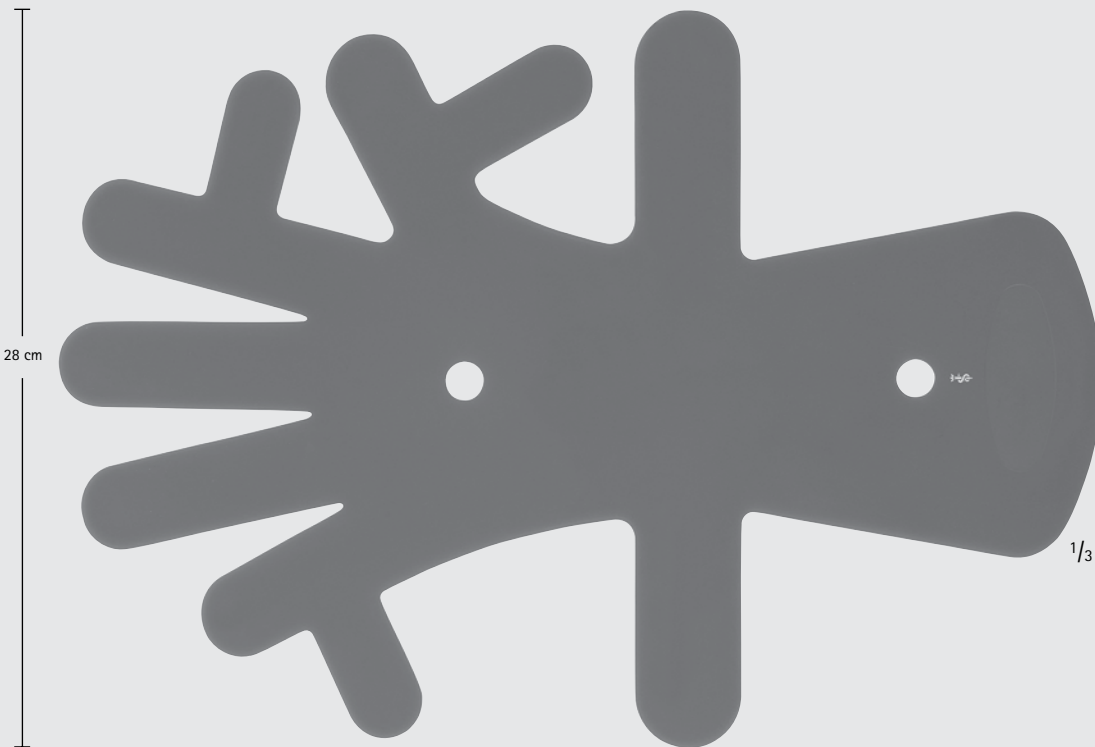

F0918A

Areola Cookie Cutter

Catalog Number	Diameter (mm)	Blade
AD123R	33.0	TOOTHED
AD125R	38.0	TOOTHED
AD127R	42.0	TOOTHED
AD129R	48.0	TOOTHED



AD123R ^{1/2}

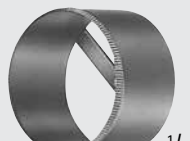

AD125R ^{1/2}



AD127R ^{1/2}



AD129R ^{1/2}



BA706R ^{1/3}

SCHINK Knife, Adjustable From 0.1 To 2.0MM

Catalog Number	Length (in.)
BA706R	11 3/4
BA708R	

BA706R Includes:
 1 Spare Blade BA708R and
 1 Skin Straightening Plate BA709R



BA708R

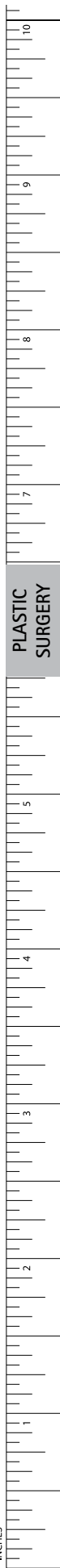

INCHES

Plastic Surgery

Knives

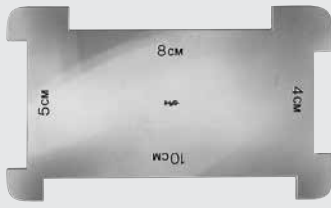

BA709R

Skin Straightening Plate

Catalog Number
BA709R



MD025

GOULIAN Skin Graft Knife Set

Catalog Number	Length (in.)
MD025	7 1/4
BA711R	BOX/50

MD025 includes 3 grafting templates: .20, .25, and .30 mm thick and blades



BA711R



MG575R

TEBBETTS Precision Knife Handle

Catalog Number	Blade Size (mm)	Length (in.)
MG575R	10 - 15	5 3/4



MG575R

PLASTIC SURGERY

MILLIMETERS

Skin Graft Knife

Catalog Number	Item	Length (in.)
BA718R	SPARE BLADE, STERILE, 10/PKG	-
BA719R	KNIFE, W/ O BLADE	11 3/4

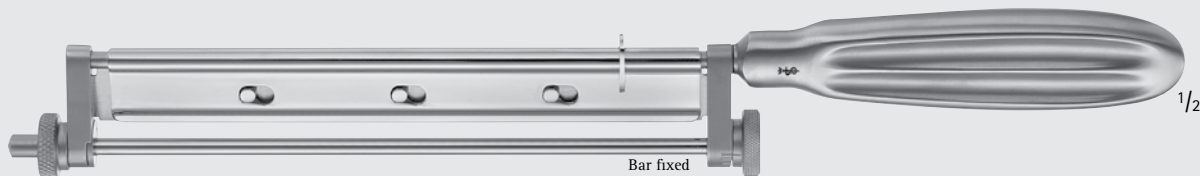

BA718R-BA719R

KEYES Dermal Punch Set

Catalog Number
OL670R

OL670R includes:
5 interchangeable tips, handle and rack



OL670R

FOX Dermal Currettes

Catalog Number	Diameter (mm)	Length (in.)
MG150R	2	5 5/8
MG151R	3	5 5/8
MG152R	4	5 5/8
MG153R	5	5 5/8
MG154R	6	5 5/8



MG150R-MG154R



MG150R



MG151R



MG152R



MG153R



MG154R



PLASTIC SURGERY

Plastic Surgery

Suction Instruments

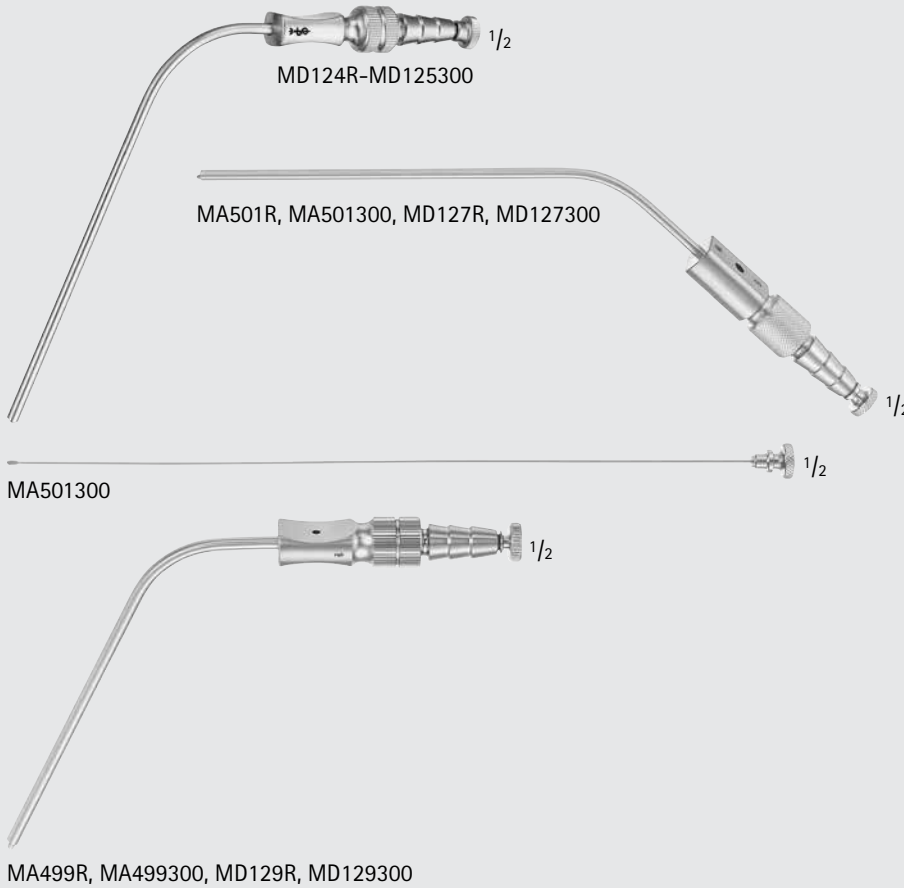

FRAZIER Suction Tube

Catalog Number	Tip Size (FR)	Description	Working Length (in.)
MD124R	7		4 1/4
MD124300	7	SUCTION STYLET W/ OLIVE TIP FOR MD124R	
MD125R	7		4 1/4
MD125300	8	SUCTION STYLET W/ OLIVE TIP FOR MD125R	
MA501R	9		4 1/4
MA501300		SUCTION STYLET W/ OLIVE TIP FOR MA501R	
MD127R	10		4 1/4
MD127300	10	SUCTION STYLET W/ OLIVE TIP FOR MD127R	
MA499R	11		4 1/4
MA499300	11	SUCTION STYLET W/ OLIVE TIP FOR MA499R	
MD129R	12		4 1/4
MD129300	12	SUCTION STYLET W/ OLIVE TIP FOR MD129R	

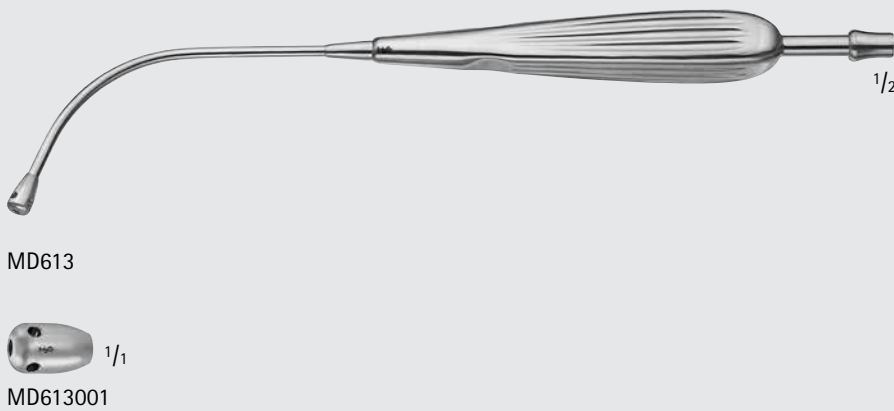

ANDREWS Pynchon Suction Tube

Catalog Number	Description	Length (in.)
MD613	-	9
MD613001	TIP ONLY F/ MD613	-

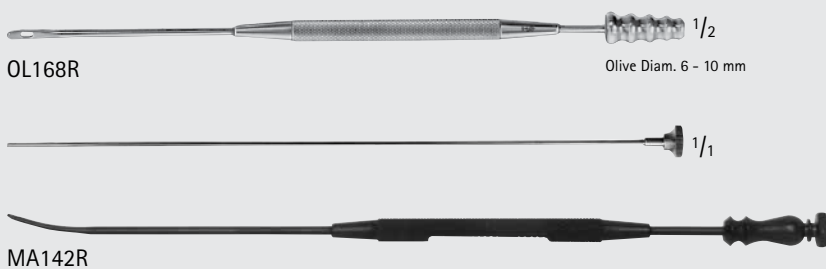

GORNEY Suction Dissector, Elevator

Catalog Number	Tip Size (mm)	Length (in.)
OL168R	6-10	7
MA142R	3	8 1/2



D0711R

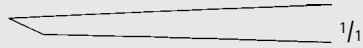

D0711R

LUCAS Chisel, Angled

Catalog Number	Tip Size (mm)	Length (in.)
D0711R	4	6 1/4



FL120R-FL128R

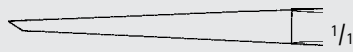

FL120R-FL128R

Chisel, Angled

Catalog Number	Tip Size (mm)	Length (in.)
FL120R	4	5 1/2
FL122R	6	5 1/2
FL124R	8	5 1/2
FL126R	10	5 1/2
FL128R	12	5 1/2



FL173R-FL176R

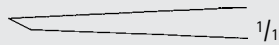

FL173R-FL176R



FL183R-FL187R

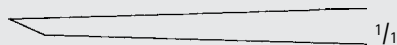

FL183R-FL187R

PARTSCH Chisel

Catalog Number	Tip Size (mm)	Length (in.)
FL173R	3	5 1/2
FL174R	4	5 1/2
FL175R	5	5 1/2
FL176R	6	5 1/2
FL183R	3	6 3/4
FL184R	4	6 3/4
FL185R	5	6 3/4
FL186R	6	6 3/4
FL187R	7	6 3/4



Plastic Surgery

Bone Instruments



D0715R

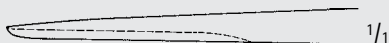

D0715R

LUCAS Gouge

Catalog Number	Tip Size (mm)	Length (in.)
D0715R	3	6 1/4



FL130R-FL136R

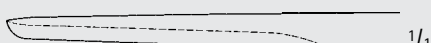

FL130R-FL136R

Gouge

Catalog Number	Tip Size (mm)	Length (in.)
FL130R	4	5 1/2
FL132R	6	5 1/2
FL134R	8	5 1/2
FL136R	10	5 1/2



FL153R

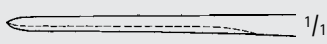

FL153R

MANNERFELT Gouge

Catalog Number	Tip Size (mm)	Length (in.)
FL153R	3	6 1/8



FL213R-FL216R



FL213R-FL216R



FL223R-FL227R

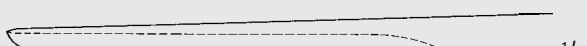

FL223R-FL227R

PARTSCH Gouge

Catalog Number	Tip Size (mm)	Length (in.)
FL213R	3	5 1/2
FL214R	4	5 1/2
FL215R	5	5 1/2
FL216R	6	5 1/2
FL223R	3	6 3/4
FL224R	4	6 3/4
FL225R	5	6 3/4
FL226R	6	6 3/4
FL227R	7	6 3/4



FL343R-FL347R

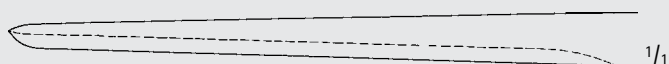

FL343R-FL347R

ALEXANDER Gouge

Catalog Number	Tip Size (mm)	Length (in.)
FL343R	7	6 3/4
FL345R	9	6 3/4
FL347R	11	6 3/4

PLASTIC SURGERY



OL307R

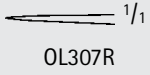

COTTLE Fishtail Chisel, W/ Protected Ends

Catalog Number	Tip Size (mm)	Length (in.)
OL307R	8	7



FL110R-FL118R

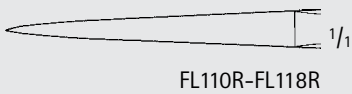

STRAND Osteotome

Catalog Number	Tip Size (mm)	Blade	Length (in.)
FL110R	4	STR	5 1/2
FL112R	6	STR	5 1/2
FL114R	8	STR	5 1/2
FL116R	10	STR	5 1/2
FL118R	12	STR	5 1/2



FL144R-FL148R

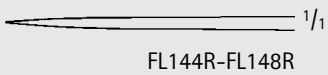

MANNERFELT Osteotome

Catalog Number	Tip Size (mm)	Length (in.)
FL144R	4	6 1/8
FL146R	6	6 1/8
FL148R	8	6 1/8



DF112R

Mallet, Lead Filled, 80gr

Catalog Number	Diameter (mm)	Length (in.)
DF112R	22	6 1/2



Plastic Surgery

Bone Instruments

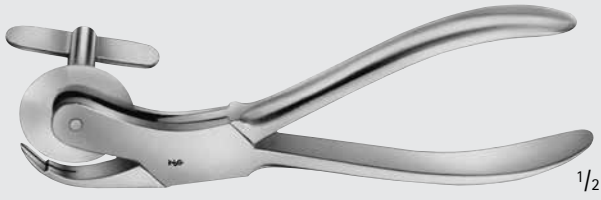

F0900R-F0901R



F0901R

Finger Ring Saw

Catalog Number	Item	Length (in.)
F0900R	COMPLETE	6
F0901R	REPLACEMENT BLADE	-



F0903R



F0903R

Nail Extracting Forceps

Catalog Number	Length (in.)
F0903R	5 1/4

PLASTIC SURGERY



D0810R

OBWEGESER Awl F/ Lower Jaw

Catalog Number	Length (in.)
D0810R	5 1/2



D0810R



D0812R

OBWEGESER Suture Wire Awl

Catalog Number	Length (in.)
D0812R	7 3/4
D0811R	9



D0812R



D0811R



D0811R



PLASTIC SURGERY

Plastic Surgery

Bone Instruments

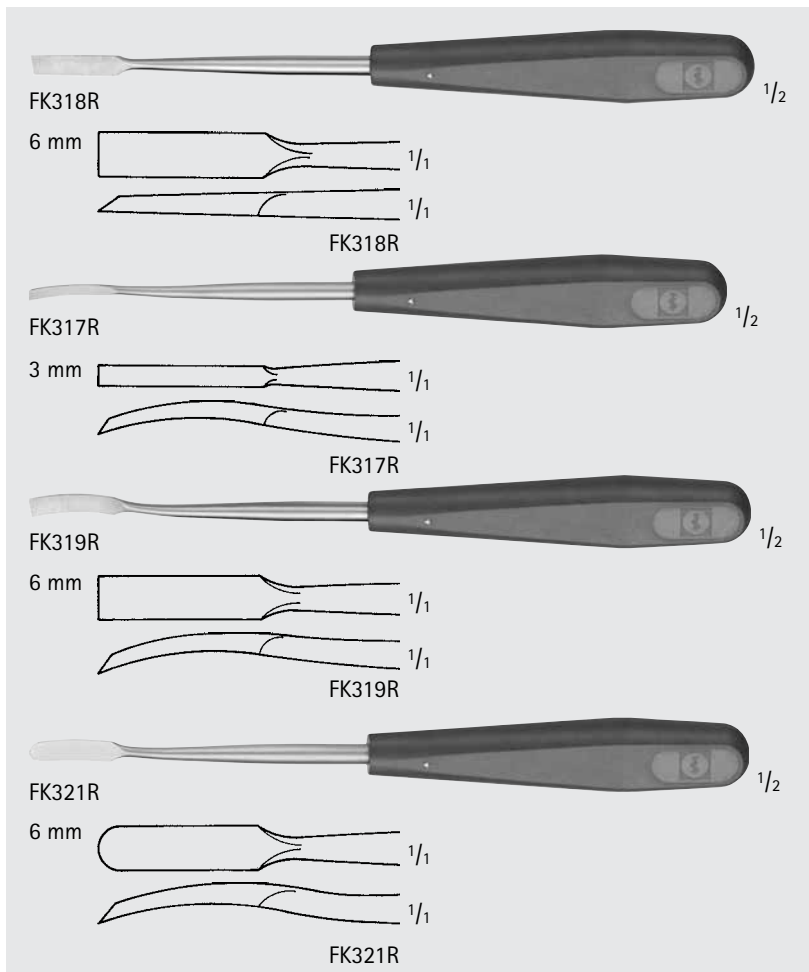
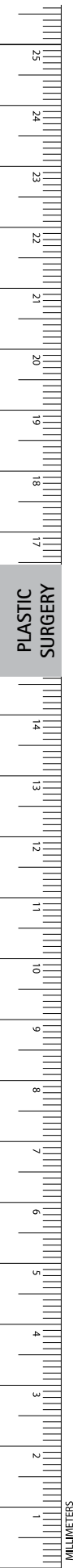

Raspatory W/ PEEK Handle

Catalog Number	Tip	Tip Size (mm)	Blade	Length (in.)
FK318R	FLAT	6	STR	7 1/2
FK317R	FLAT	3	CVD	7 1/4
FK319R	FLAT	6	CVD	7 1/2
FK321R	RND	6	CVD	7 1/2

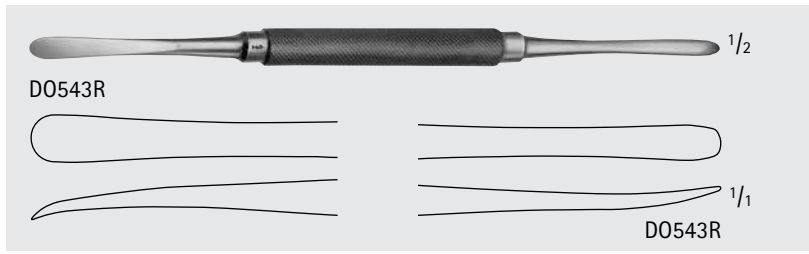

MOLT Raspatory and Elevator, Double Ended

Catalog Number	Length (in.)
D0543R	7

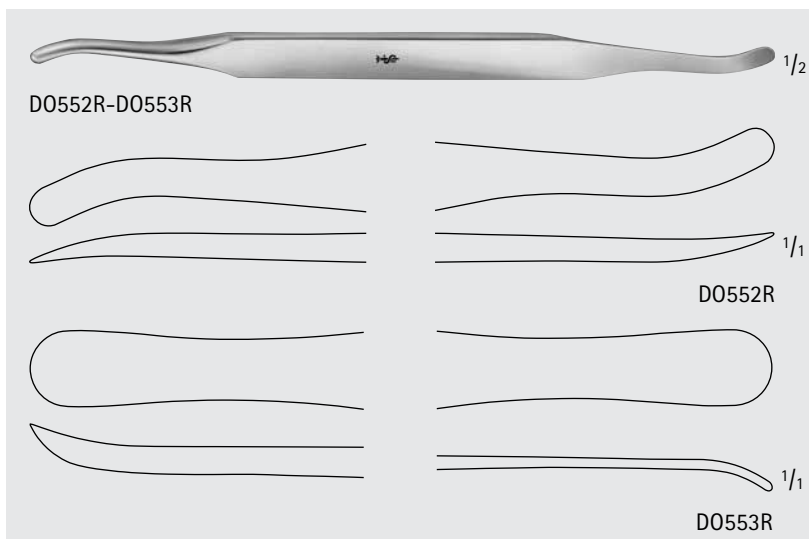

SELDIN Raspatory, Double Ended

Catalog Number	Size	Length (in.)
D0552R	SMALL	7 3/4
D0553R	LARGE	7 3/4



D0773R

MILLER Bone Rasp

Catalog Number	Tip Size (mm)	Length (in.)
D0773R	6.0 / 5.0	7

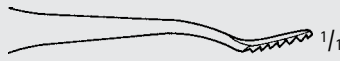

D0773R

5 mm



FK530R-FK552R

MANNERFELT Modified Elevator

Catalog Number	Tip	Tip Size (mm)	Length (in.)
FK530R	SPOON	4	6 1/8
FK532R	SPOON	7	6 1/8
FK534R	SPOON	9	6 1/8
FK541R	CVD	3	6 1/8
FK543R	CVD	6	6 1/8
FK552R	SLIGHT-CVD, ROUND	8	6 1/8

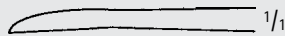
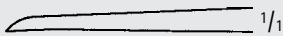

FK530R

FK532R

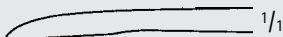

FK534R

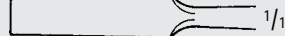
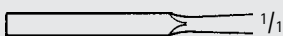
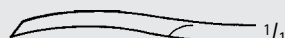
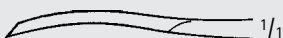

FK541R

FK543R

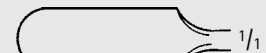
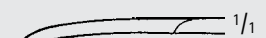

FK552R

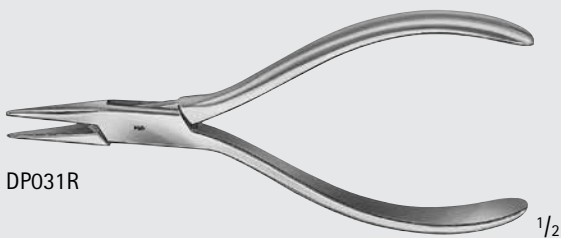

DP031R

MARBURG Needle Nose Pliers

Catalog Number	Tip	Length (in.)
DP031R	SERR	5 1/2



DP031R

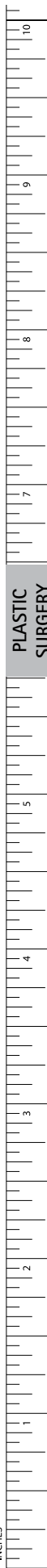

PLASTIC SURGERY

INCHES

Plastic Surgery

Bone Instruments



Universal Wire Cutter

Catalog Number	For Wire Size	Length (in.)
DP501R	SOFT, UP TO 1.5MM AND HARD, UP TO 1.0MM	6
DP505R	SOFT, UP TO 1.5MM AND HARD, UP TO 1.2MM	6 1/4

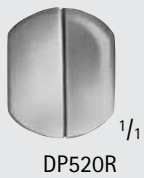

Wire Cutter, W/ Specially Hardened Cutting Edges

Catalog Number	For Wire Size	Blade End	Length (in.)
DP520R	SOFT, UP TO 1.5MM AND	X-HARD EDGE	5 3/4
DP530R	SOFT, UP TO 1.5MM AND	X-HARD EDGE	5 1/2

PLASTIC SURGERY

MILLIMETERS

DUROTIP™ TC Wire Cutting Scissors

Catalog Number	For Wire Size	Blade	Length (in.)
DP552R	SOFT, UP TO 1.2MM AND HARD, UP TO 0.8 MM	1-SERR	4 3/4

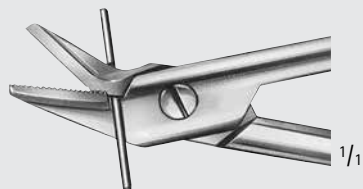
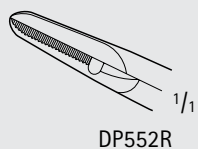
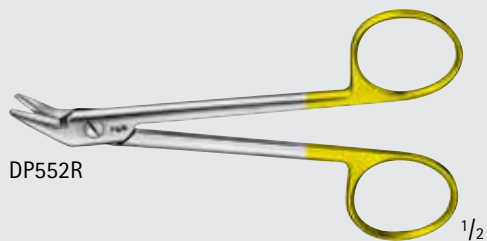

BEEBE Crown Scissors

Catalog Number	Tip	Blade	Length (in.)
DP560R	SHARP	STR	4 1/4
DP561R	SHARP	CVD	4 1/4
DP563R	BROAD	CVD	4 1/4
DP569R	ONE-SERR	CVD	4 1/4

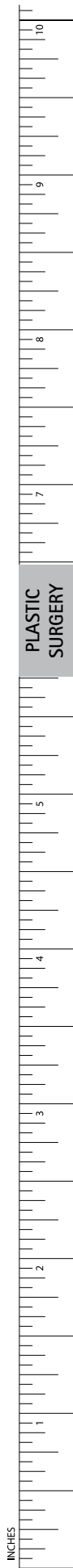
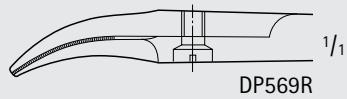
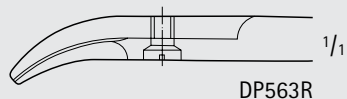
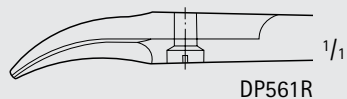
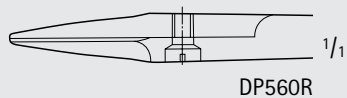

Plastic Surgery

Micro Vessel Clips and Clamps

- The arterial clips have a slightly inwards curved jaw tip to prevent slipping, see Fig.1
- The venous clips have a flat parallel closing jaw, see Fig. 2

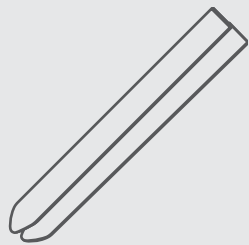

Fig. 1

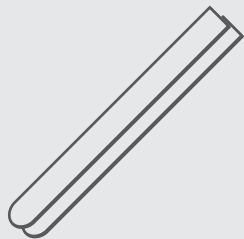
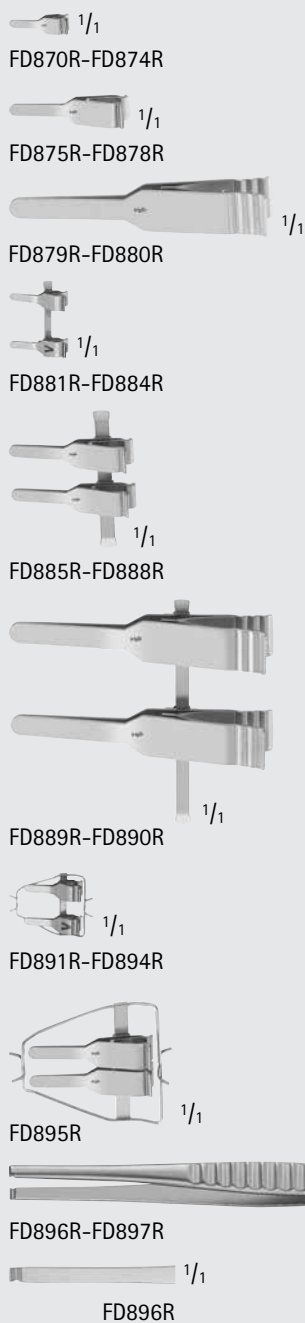

Fig. 2



ACLAND Micro Vessel Clips

Catalog Number	Jaw Length (mm)	Size	Description	Vessel Size (mm)
FD870R	8	B-1	Artery	0.3-1.0
FD871R	8	B-1	Vein	0.3-1.0
FD872R	11	B-2	Artery	0.6-1.4
FD873R	11	B-2	Vein	0.6-1.4
FD874R	16	B-3	Artery	1.0-2.2
FD875R	16	B-3	Vein	1.0-2.2
FD876R	24	HD-S	Artery	1.5-3.3
FD877R	24	HD-S	Vein	1.5-3.3
FD878R	35	RD-S	Artery	2.0-5.0
FD879R	35	RD-S	Vein	2.0-5.0
FD880R	8	B-1	Artery	0.3-1.0
FD881R	8	B-1	Vein	0.3-1.0
FD882R	11	B-2	Artery	0.6-1.4
FD883R	11	B-2	Vein	0.6-1.4
FD884R	16	B-3	Artery	1.0-2.2
FD885R	16	B-3	Vein	1.0-2.2
FD886R	24	HD-D	Artery	1.5-3.3
FD887R	24	HD-D	Vein	1.5-3.3
FD888R	35	RD-D	Artery	2.0-5.0
FD889R	35	RD-D	Vein	2.0-5.0
FD890R	8	B-1	Artery	0.3-1.0
FD891R	8	B-1	Vein	0.3-1.0
FD892R	11	B-2	Artery	0.6-1.4
FD893R	11	B-2	Vein	0.6-1.4
FD894R	16	B-3	Artery	1.0-2.2
FD895R	16	B-3	Vein	1.0-2.2
FD896R	5 1/2	B-1, B-2	Clip Applying Forceps	-
FD897R	5 1/2	B-3, HD, RD	Clip Applying Forceps	-

All items are sold individually

PLASTIC SURGERY

Plastic Surgery

Micro Vessel Clips and Clamps



FD560R-FD562R

BIEMER Vessel Clip

Catalog Number	Jaw Length (mm)	Jaw Opening (mm)	Closing Force
FD560R	6	4	30 - 40
FD561R	9	5	30 - 40
FD562R	9	5	20 - 25

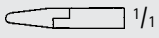

FD560R

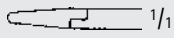

FD561R

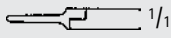

FD562R



FD568R

BIEMER Applying Forceps, F/ FD560R-FD562R, FD611R-FD615R

Catalog Number	Description	Length (in.)
FD568R	W/ O LOCK	5 1/2
FD569R	W/ LOCK	5 1/2



FD569R



FD571R

BIEMER Micro Approximator Only

Catalog Number	Jaw Length (mm)	Jaw Opening (mm)	Closing Force (gr)
FD571R	6	2	30 - 40

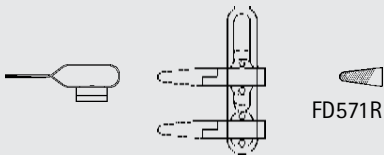

FD571R



FD572R

BIEMER Applying Forceps, F/ FD571R

Catalog Number	Length (in.)
FD572R	5 3/4



FD572R

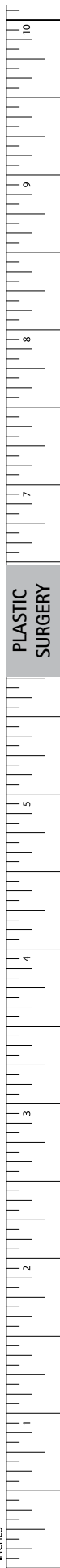

PLASTIC SURGERY

INCHES

Plastic Surgery

Micro Vessel Clips and Clamps



FD575R



FD576R



Micro Approximator

Catalog Number	Description
FD575R	COMPLETE WITH KEY
FD576R	KEY ALONE

BIEMER-MÜLLER Approximator

Catalog Number	Blade	Jaw Length (mm)	Jaw Opening (mm)	Closing Force (gr)
FD613R	STR, DEL	9	4	25 - 30
FD615R	STR	4,5	3	25 - 30
FD611R	STR	9	3	25 - 30
FD614R	ANG, DEL	9	3	25 - 30
FD612R	ANG	9	3	25 - 30



FD613R



FD615R



FD611R



FD614R



FD612R

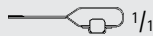
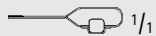
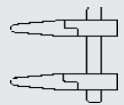
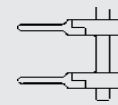
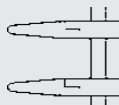
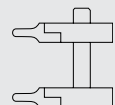
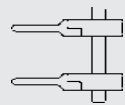

FD576R



FD635R

BIEMER Approximator, F/ Nerves

Catalog Number	Description
FD576R	KEY ALONE
FD635R	APPROXIMATOR COMPLETE WITH KEY AND NEEDLES
FD636R	SPARE NEEDLES, PR

PLASTIC SURGERY

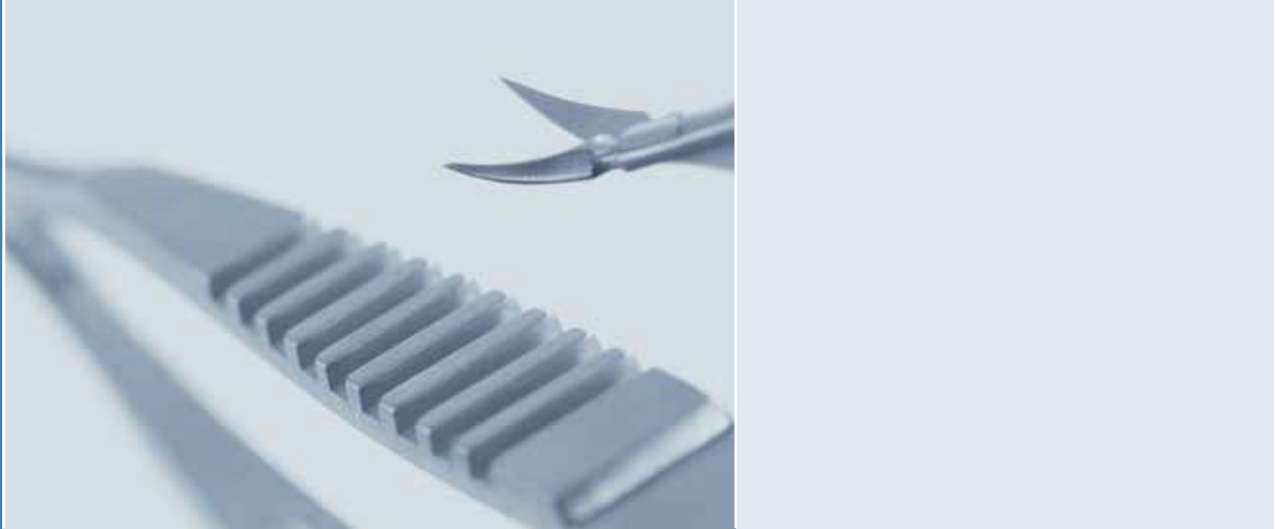

Eye

Scissors	812 - 828
Micro Needle Holders	829 - 831
Forceps	832 - 844
Specula	845 - 847
Hooks and Retractors	847 - 849
Hooks / Retractors / Manipulators	850 - 861
Fixation Rings and Markers	862 - 864
Probes and Dilators	865 - 866
Lacrimal Intubation Sets	867 - 868
Cannulas	869 - 875
Miscellaneous	876 - 877

Eye Scissors



BC190R, MA471R-MA474R, MB605R



MB605R $\frac{1}{1}$



BC190R $\frac{1}{1}$

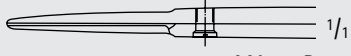

MA473R $\frac{1}{1}$

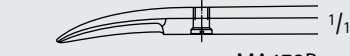

MA472R $\frac{1}{1}$

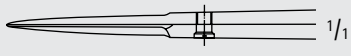

MA471R $\frac{1}{1}$

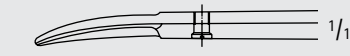

MA474R $\frac{1}{1}$

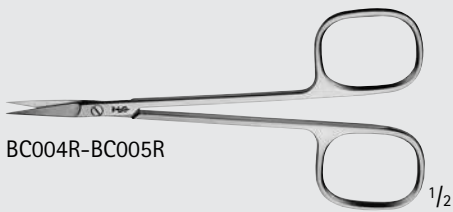

BC004R-BC005R $\frac{1}{2}$

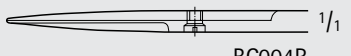

BC004R $\frac{1}{1}$

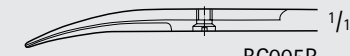

BC005R $\frac{1}{1}$

Iris Scissors

Catalog Number	Tip	Blade	Handle	Length (in.)
MB605R	S/S	STR	RIBBON	4
MA471R	S/S	STR	RIBBON	4 1/4
MA473R	B/B	STR	RIBBON	4 1/4
BC190R	S/S	CVD	RIBBON	4
MA472R	S/S	CVD	RIBBON	4 1/4
MA474R	B/B	CVD	RIBBON	4 1/4
BC004R	S/S	STR	SQUARE	4 1/2
BC005R	S/S	CVD	SQUARE	4 1/2

EYE

Iris Scissors (continued)

Catalog Number	Tip	Blade	Handle	Length (in.)
BC100R	S/S	STR	ROUND	3 1/2
BC056R	S/S	STR	ROUND	3 3/4
BC060R	S/S	STR	ROUND	4 1/8
BC110R	S/S	STR	ROUND	4 1/4
BC112R	S/B	STR	ROUND	4 1/4
BC106R	S/S	STR	ROUND	4 1/2
BC064R	S/S	STR	ROUND	4 3/4
BC101R	S/S	CVD	ROUND	3 1/2
BC057R	S/S	CVD	ROUND	3 3/4
BC061R	S/S	CVD	ROUND	4 1/8
BC111R	S/S	CVD	ROUND	4 1/4
BC113R	S/B	CVD	ROUND	4 1/4
BC107R	S/S	CVD	ROUND	4 1/2
BC065R	S/S	CVD	ROUND	4 3/4
BC117R	S/S	LAT-ANG	ROUND	4 1/4
BC050R	S/S	STR	ROUND, CENTERED	4 1/4

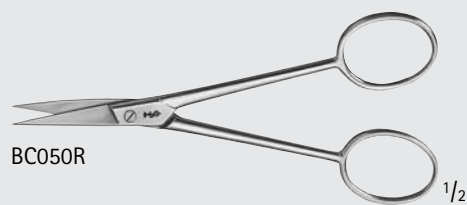
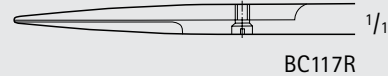
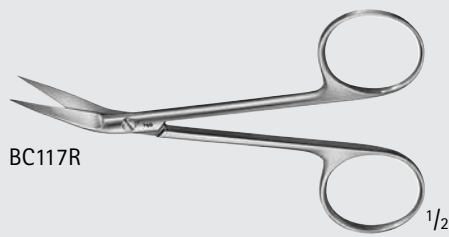
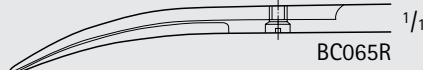
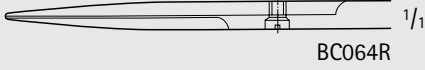
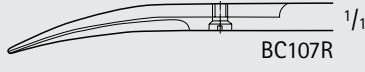
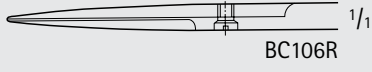
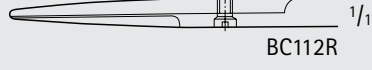
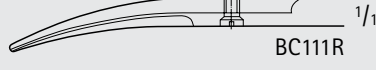
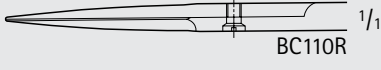
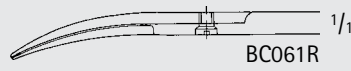
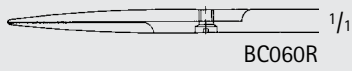
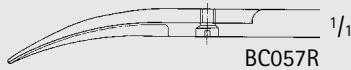
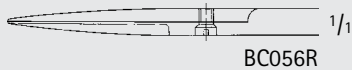
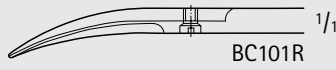
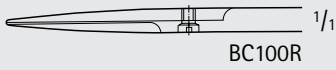

EYE

INCHES

Eye Scissors



MA468R-MA470R

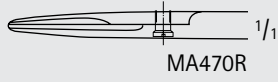

MA470R

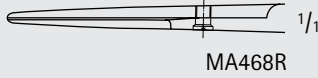

MA468R

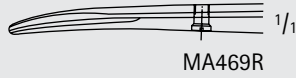

MA469R

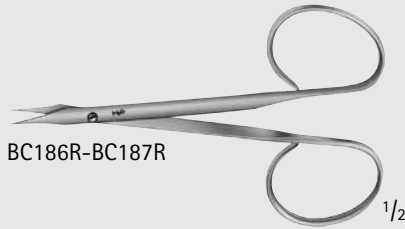

BC186R-BC187R

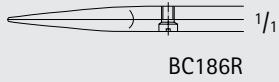

BC186R

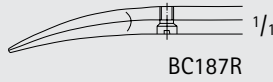

BC187R

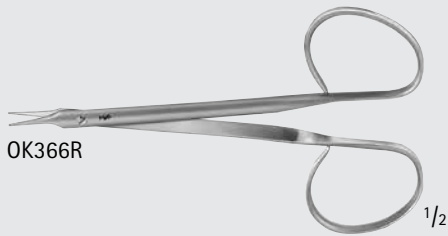

OK366R

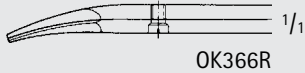

OK366R

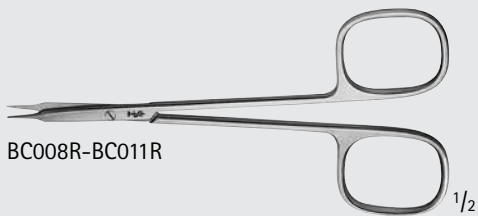

BC008R-BC011R

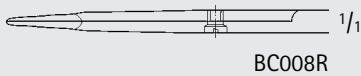

BC008R

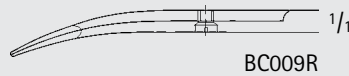

BC009R

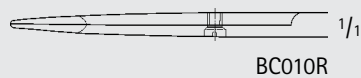

BC010R

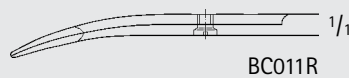

BC011R

STEVENS Tenotomy Scissors

Catalog Number	Tip	Blade	Handle	Length (in.)
BC186R	S/S	STR	RIBBON	4
MA470R	B/B	STR	RIBBON	3 3/4
MA468R	B/B	STR	RIBBON	3 7/8
MA469R	B/B	CVD	RIBBON	3 3/4
BC187R	S/S	CVD	RIBBON	4
OK366R	B/B	CVD	RIBBON	4 1/4
BC008R	S/S	STR	SQUARE	4 1/2
BC010R	B/B	STR	SQUARE	4 1/2
BC009R	S/S	CVD	SQUARE	4 1/2
BC011R	B/B	CVD	SQUARE	4 1/2

**STEVENS Tenotomy Scissors
(continued)**

Catalog Number	Tip	Blade	Handle	Length (in.)
BC170R	S/S	STR	ROUND	4 1/4
BC172R	B/B	STR	ROUND	4 1/4
BC194R	B/B	STR	ROUND	5
MA467R	B/B	STR	ROUND	5 3/4
BC171R	S/S	CVD	ROUND	4 1/4
BC173R	B/B	CVD	ROUND	4 1/4
BC195R	B/B	CVD	ROUND	5
MA466R	B/B	CVD	ROUND	5 3/4

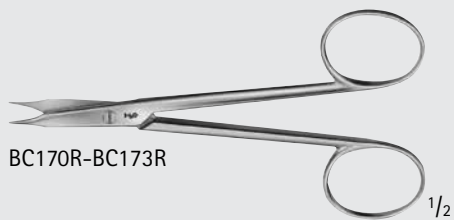

BC170R-BC173R

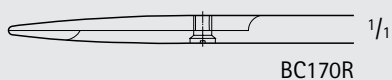

BC170R

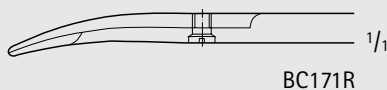

BC171R

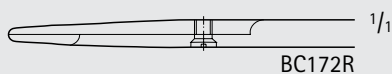

BC172R

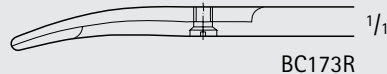

BC173R



BC194R-BC195R

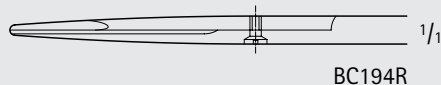

BC194R

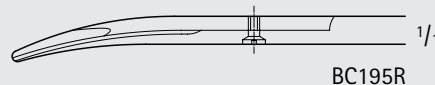

BC195R

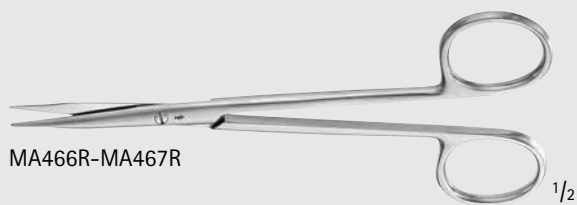

MA466R-MA467R

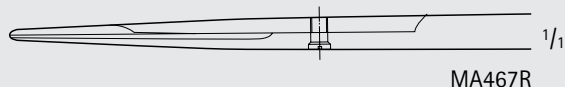

MA467R

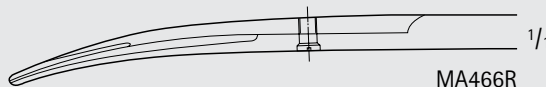

MA466R

JAMESON-WERBER Tenotomy Scissors

Catalog Number	Tip	Blade	Length (in.)
BC175R	B/B	DEL, CVD	5 1/8

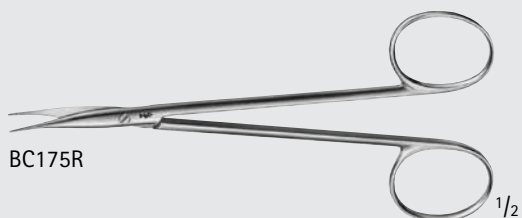

BC175R

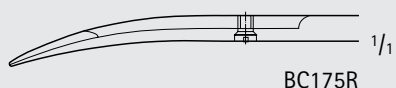

BC175R



Eye Scissors



Strabismus Scissors, Delicate

Catalog Number	Tip	Blade	Handle	Length (in.)
MA610R	B/B	CVD	RIBBON	4 1/4
BC020R	B/B	STR	SQUARE	4 1/2
BC021R	B/B	CVD	SQUARE	4 1/2
BC164R	B/B	STR	ROUND	4 1/2
BC165R	B/B	CVD	ROUND	4 1/2

KNAPP Strabismus Scissors, Delicate

Catalog Number	Tip	Blade	Length (in.)
MA462R	B/B	STR	4 3/4
MA461R	B/B	CVD	4 3/4



Enucleation Scissors

Catalog Number	Tip	Blade	Length (in.)
OC430R	B/B	SLIGHT CVD	5
US141	B/B	MEDIUM CVD	5 1/4
MA874R	B/B	FULL CVD	5 1/8



MA874R, OC430R, US141R

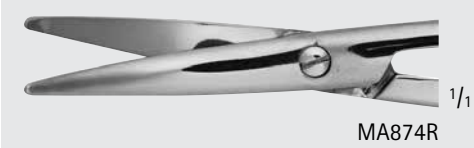

MA874R

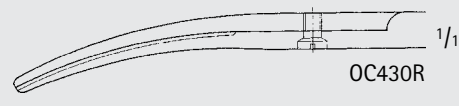

OC430R



US141

Eye Scissors

Catalog Number	Tip	Blade	Length (in.)
MA475R	PROBE	ANG	4 1/2

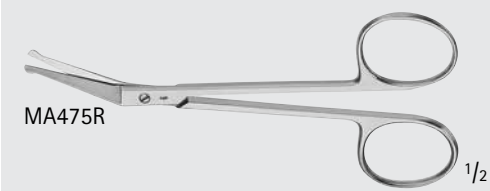

MA475R

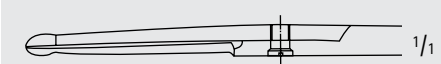

MA475R

Utility Scissors, Ribbon Handle

Catalog Number	Tip	Blade	Length (in.)
MA476R	B/B	STR	4
MA477R	B/B	CVD	4
MA478R	B/B	CVD	4

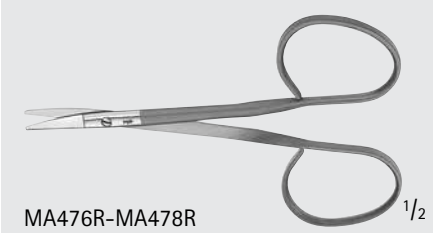

MA476R-MA478R

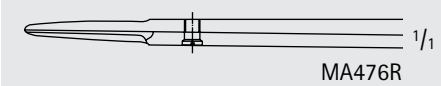

MA476R

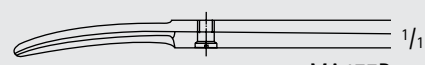

MA477R

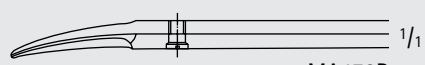

MA478R

Eye Scissors



MA479R-MA480R

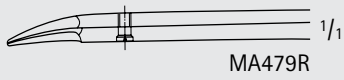

MA479R

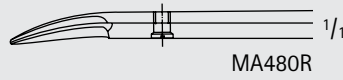

MA480R

Stitch Scissors, Ribbon Handle

Catalog Number	Tip	Blade	Length (in.)
MA479R	S/S	CVD	3 3/4
MA480R	S/S	CVD	4 3/4



MA976R



MA976R

Stitch Scissors

Catalog Number	Tip	Blade	Length (in.)
MA976R	S/S	STR	4

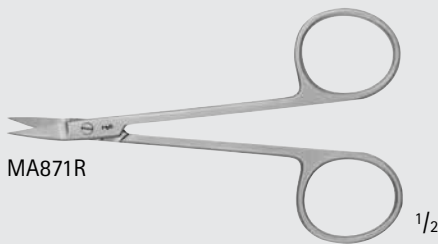

MA871R



MA871R

WILMER Conjunctival Scissors

Catalog Number	Tip	Blade	Length (in.)
MA871R	S/S	ANG-FLAT	4 1/8

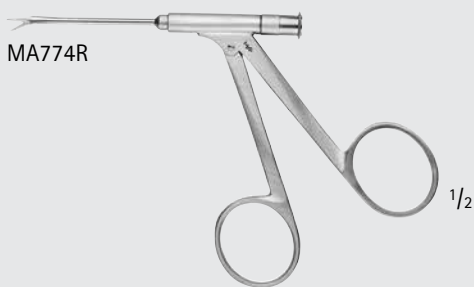

MA774R



MA774R

IOL Cutter

Catalog Number	Blade	Blade Length (mm)	Diameter (mm)	Length (in.)
MA774R	SERR	6	2	4 1/2

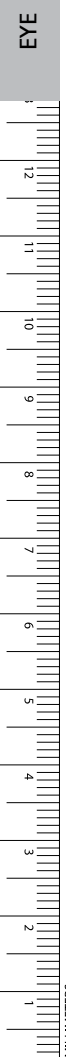

DUROTIP Tungsten Carbide (TC) Scissors

- Excellent cutting accuracy
- Long working life
- Gold-plated rings



BC210R-BC211R

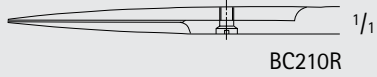

BC210R

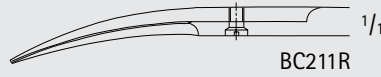

BC211R

DUROTIP TC Iris Scissors, Delicate

Catalog Number	Tip	Blade	Length (in.)
BC210R	S/S	STR	4 1/4
BC211R	S/S	CVD	4 1/4

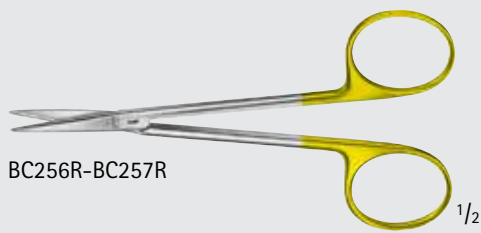

BC256R-BC257R

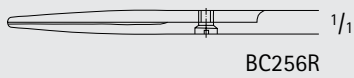

BC256R

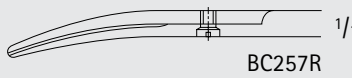

BC257R

DUROTIP TC Strabismus Scissors, Delicate

Catalog Number	Tip	Blade	Length (in.)
BC256R	B/B	STR	4 1/2
BC257R	B/B	CVD	4 1/2



Eye

DUROTIP™ Scissors



Wavecut

- Wavecut scissors have one serrated cutting edge to help prevent tissue from slipping. The W after the item number indicates the scissors are the wavecut style, e.g. BC211W.



BC211W

1/2

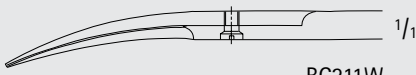

BC211W

1/1

DUROTIP TC Iris Scissors, Wavecut

Catalog Number	Tip	Blade	Length (in.)
BC211W	S/S	CVD	4 1/4

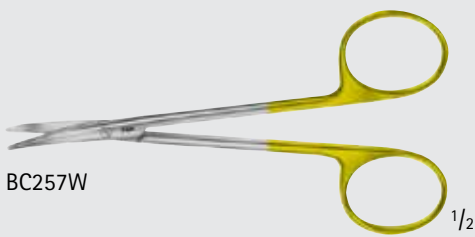

BC257W

1/2

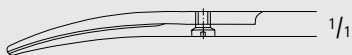

BC257W

1/1

DUROTIP TC Strabismus Wavecut Scissors

Catalog Number	Tip	Blade	Length (in.)
BC257W	B/B	CVD	4 1/2

EYE

MILLIMETERS



OC498R-OC500R

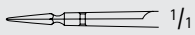

OC498R

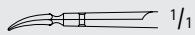

OC499R



OC500R

VANNAS Micro Scissors

Catalog Number	Tip	Blade	Handle	Length (in.)
OC498R	S/S	STR	FLAT, SERR	3 1/4
OC499R	S/S	CVD	FLAT, SERR	3 1/4
OC500R	S/S	ANG	FLAT, SERR	3 1/4



FD011R-FD015R

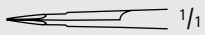

FD014R

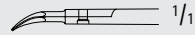

FD015R

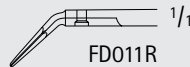

FD011R

VANNAS Micro Scissors

Catalog Number	Tip	Blade	Handle	Length (in.)
FD014R	S/S	STR	FLAT, SERR	4 3/4
FD015R	S/S	CVD	FLAT, SERR	4 3/4
FD011R	S/S	ANG	FLAT, SERR	4 3/4
FD018R	S/S	STR	FLAT, SERR	6 1/4
FD019R	S/S	CVD	FLAT, SERR	6 1/4



FD018R-FD019R

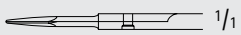

FD018R

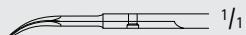

FD019R



MA865R

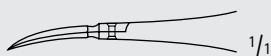

MA865R

VANNAS Micro Scissors, Wide Handle

Catalog Number	Tip	Tip Size (mm)	Blade	Handle	Length (in.)
MA865R	S/S	10	CVD	FLAT, WIDE SERR	4 3/4



Eye Scissors

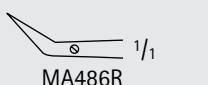
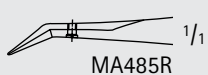
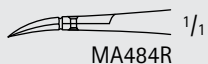
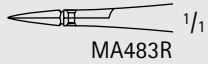

VANNAS Capsulotomy Scissors

Catalog Number	Tip	Blade	Handle	Length (in.)
MA483R	S/S	STR	FLAT, SERR	3 1/4
MA484R	S/S	CVD	FLAT, SERR	3 1/4
MA485R	S/S	ANG-DOWN	FLAT, SERR	3 1/4
MA486R	S/S	ANG-UP	FLAT, SERR	3 1/4

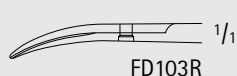
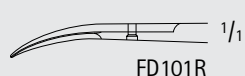
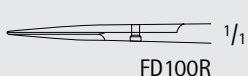
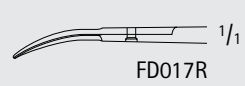
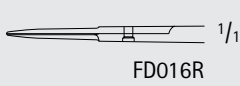
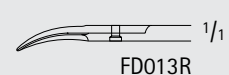
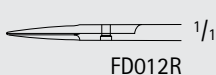
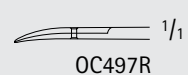
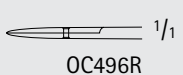

Micro Scissors

Catalog Number	Tip	Blade	Handle	Length (in.)
OC496R	S/S	STR	FLAT, SERR	4 1/8
OC497R	S/S	CVD	FLAT, SERR	4 1/8
FD012R	S/S	STR	FLAT, SERR	4 3/4
FD013R	S/S	CVD	FLAT, SERR	4 3/4
FD016R	S/S	STR	FLAT, SERR	6 1/4
FD017R	S/S	CVD	FLAT, SERR	6 1/4
FD100R	S/S	STR	ROUND	5 3/4
FD101R	S/S	CVD	ROUND	5 3/4
FD103R	B/B	CVD	ROUND	5 3/4

EYE

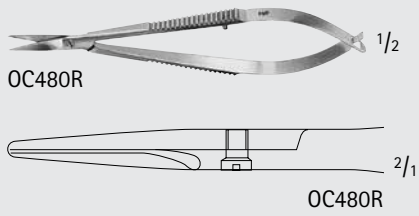

MCCLURE Micro Scissors

Catalog Number	Tip	Blade	Handle	Length (in.)
OC480R	S/S	STR	FLAT, SERR	3 3/4

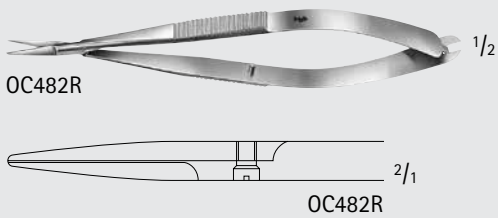

NOYES Micro Scissors

Catalog Number	Tip	Blade	Handle	Length (in.)
OC482R	S/B	STR	FLAT, SERR	5

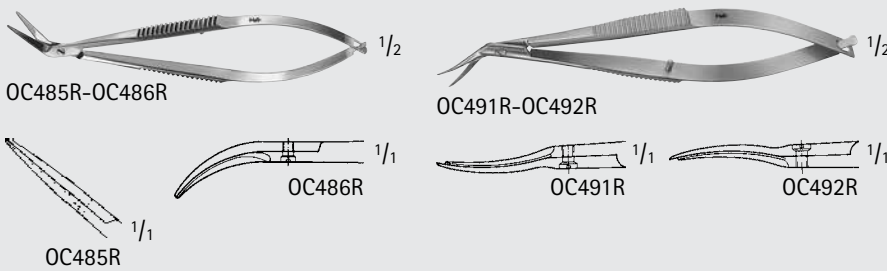

CASTROVIEJO Corneal Scissors

Catalog Number	Tip	Blade	Handle	Length (in.)
OC485R	B/B	LAT-ANG	FLAT, SERR	3 3/4
OC486R	B/B	LAT-CVD	FLAT, SERR	3 3/4
OC491R	B/B	LEFT-CVD	FLAT, SERR	4 3/8
OC492R	B/B	RIGHT-CVD	FLAT, SERR	4 3/8

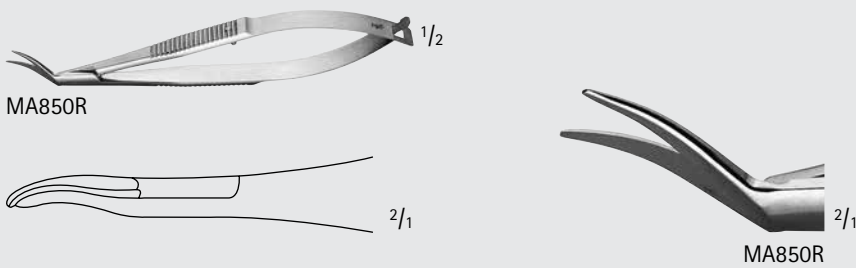

CASTROVIEJO Corneal Section Scissors

Catalog Number	Tip	Tip Size (mm)	Blade	Handle	Length (in.)
MA850R	B/B	9	CVD, ANG RIGHT	FLAT, SERR	4 1/4
MA851R	B/B	9	CVD, ANG LEFT	FLAT, SERR	4 1/4

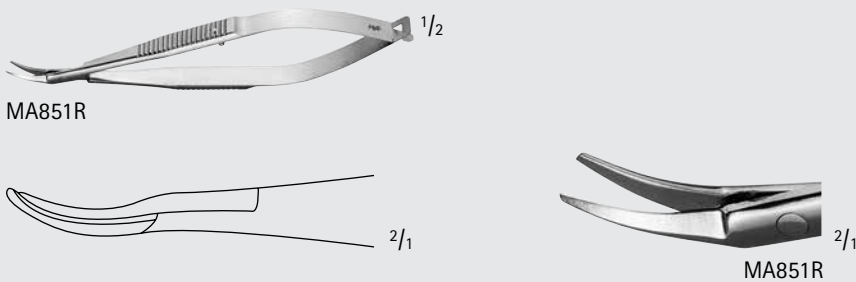

Eye Scissors



MA858R



MA858R

CASTROVIEJO Universal Corneal Scissors

Catalog Number	Tip	Tip Size	Blade	Handle	Length (in.)
MA858R	B/B	16 MM FROM MID-SCREW	CVD	FLAT, FENESTRATED	4 3/4



MA848R

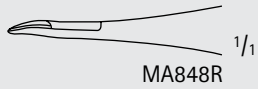

MA848R



MA849R

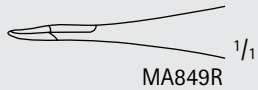

MA849R

CASTROVIEJO Corneal Scissors

Catalog Number	Tip	Tip Size	Blade	Handle	Length (in.)
MA848R	B/B	SMALL	CVD RIGHT	FLAT, WIDE SERR	4
MA849R	B/B	SMALL	CVD LEFT	FLAT, WIDE SERR	4



MA852R

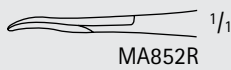

MA852R



MA853R

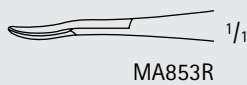

MA853R

TROUTMAN-CASTROVIEJO Corneal Scissors, W/ Catch

Catalog Number	Tip	Tip Size	Blade	Handle	Length (in.)
MA852R	B/B	MEDIUM	CVD RIGHT	FLAT, WIDE SERR	4 1/8
MA853R	B/B	MEDIUM	CVD LEFT	FLAT, WIDE SERR	4 1/8



MA854R

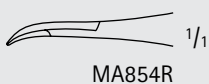

MA854R



MA855R

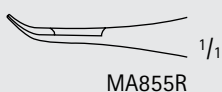

MA855R

TROUTMAN-KATZIN Corneal Scissors, W/ Catch

Catalog Number	Tip	Blade	Handle	Length (in.)
MA854R	B/B	STRONG CVD RIGHT	FLAT, WIDE SERR	4 1/8
MA855R	B/B	STRONG CVD LEFT	FLAT, WIDE SERR	4 1/8

EYE



MA847R

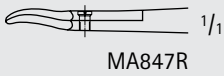

MA847R

TROUTMAN Corneal Scissors, W/ Catch

Catalog Number	Tip	Blade	Handle	Length (in.)
MA847R	B/B	CVD RIGHT	FLAT, WIDE SERR	4 1/8



MA859R

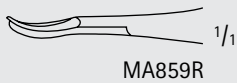

MA859R

KATZIN Corneal Transplant Scissors

Catalog Number	Tip	Tip Size	Blade	Handle	Length (in.)
MA859R	B/B	MEDIUM	CVD RIGHT	FLAT, FENESTRATED	4 1/8
MA860R	B/B	MEDIUM	CVD LEFT	FLAT, FENESTRATED	4 1/8



MA860R



MA860R



MA856R

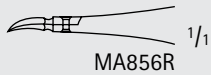

MA856R

RICH Corneal Scissors

Catalog Number	Tip	Tip Size	Blade	Handle	Length (in.)
MA856R	S/S	X-DEL	CVD RIGHT	FLAT, WIDE SERR	4 1/8
MA857R	S/S	X-DEL	CVD LEFT	FLAT, WIDE SERR	4 1/8



MA857R

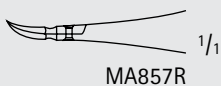

MA857R



MA873R

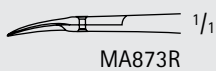

MA873R

Micro Iris Scissors

Catalog Number	Tip	Tip Size	Blade	Handle	Length (in.)
MA873R	S/S	10 MM FROM MID-SCREW	CVD	FLAT, SERR	4 1/8



EYE

INCHES

Eye Scissors

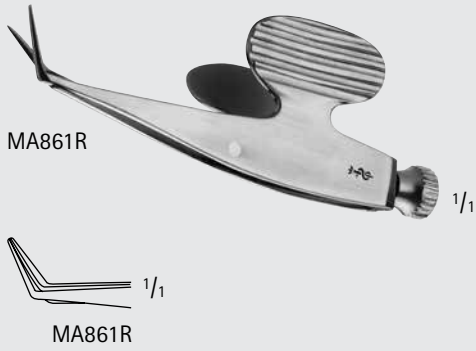

BARRAQUER Iris Scissors

Catalog Number	Tip	Tip Size (mm)	Blade	Length (in.)
MA861R	B/B	8	ANG	2 1/4



JAFFE Stitch Scissors

Catalog Number	Tip	Blade	Handle	Length (in.)
MA862R	X-SHARP/ X-SHARP	CVD	FLAT, WIDE SERR	4 3/4

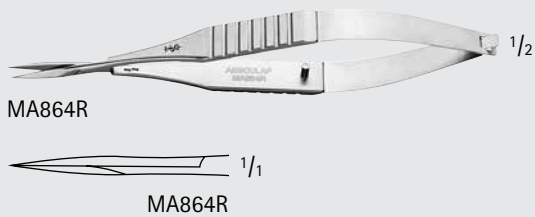

Stitch Scissors, Fine

Catalog Number	Tip	Blade	Handle	Length (in.)
MA864R	S/S	STR	FLAT, WIDE SERR	5 1/8

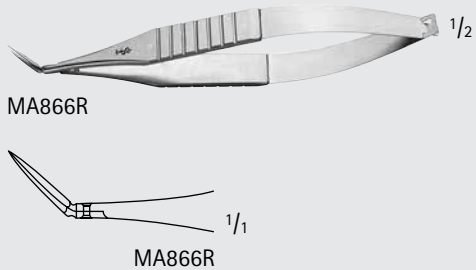

STERN-GILLS Scissors

Catalog Number	Tip	Tip Size (mm)	Blade	Handle	Length (in.)
MA866R	S/S	10	STR-ANG FORWARD	FLAT, WIDE SERR	4 1/2

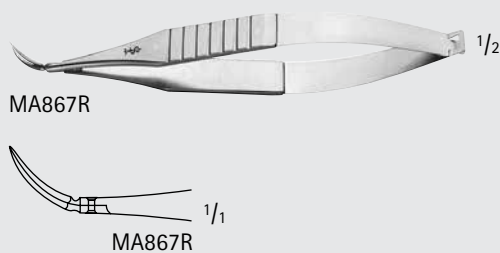

URIBE-STERN Scissors

Catalog Number	Tip	Tip Size (mm)	Blade	Handle	Length (in.)
MA867R	S/S	10	CVD-ANG FORWARD	FLAT, WIDE SERR	4 3/4



UTHOFF-GILLS Capsulotomy Scissors

Catalog Number	Tip	Tip Size (mm)	Blade	Handle	Length (in.)
MA868R	B/B	10	ANG, CVD	FLAT, WIDE SERR	4 3/4



MA868R

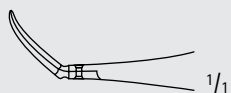

MA868R

GILLS-WELSH VANNAS Scissors

Catalog Number	Tip	Tip Size (mm)	Handle	Length (in.)
MA870R	S/S	11	FLAT, WIDE SERR	3 1/4



MA870R

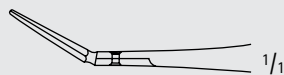

MA870R

DEWECKER Iris Scissors

Catalog Number	Tip	Blade	Length (in.)
MA612R	S/B	CVD	4 1/2



MA612R

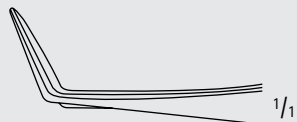

MA612R



INCHES

Eye Scissors

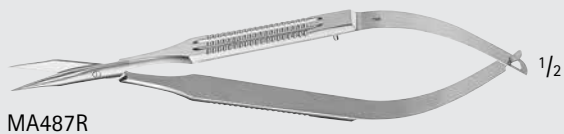

MA487R

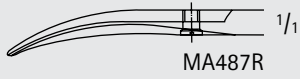

MA487R



US137-US138

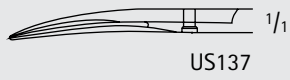

US137

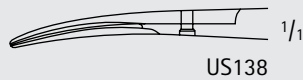

US138

WESTCOTT Stitch and Utility Scissors

Catalog Number	Tip	Blade	Handle	Length (in.)
MA487R	S/S	CVD	FLAT, SERR	5 1/2
US137	S/S	CVD	FLAT, SERR	4 1/2
US138	B/B	CVD	FLAT, SERR	4 1/2



MA613R

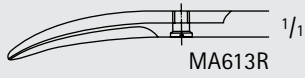

MA613R

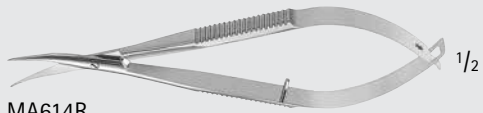

MA614R

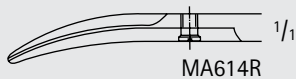

MA614R

WESTCOTT Tenotomy Scissors

Catalog Number	Tip	Blade	Handle	Length (in.)
MA613R	B/B	CVD, RIGHT HAND	FLAT, SERR	4 3/4
MA614R	B/B	CVD, LEFT HAND	FLAT, SERR	4 3/4



FD020R-FD021R

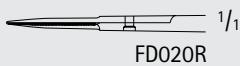

FD020R

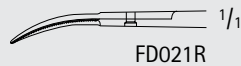

FD021R

MILLES I Micro Scissors

Catalog Number	Tip	Blade	Handle	Length (in.)
FD020R	S/S	STR, SERR	FLAT, SERR	6 1/4
FD021R	S/S	CVD, SERR	FLAT, SERR	6 1/4



MA360R



MA360R



BM560R, BM562R

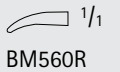

BM560R

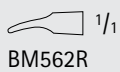

BM562R



FD230R-FD231R

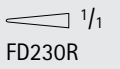

FD230R

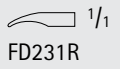

FD231R



MA352R

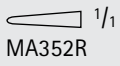

MA352R



MA357R



MA357R

**BARRAQUER Micro Needle Holder,
Round Knurled Handle W/O Catch**

Catalog Number	Tip	Length (in.)
FD230R	STR	4 3/4
MA352R	STR	5 1/4
BM562R	CVD, DEL	4 3/4
MA360R	CVD	4 1/4
BM560R	CVD	4 1/2
FD231R	CVD	4 3/4
MA357R	CVD	5 1/4



FD232R-FD233R

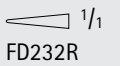

FD232R

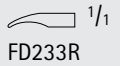

FD233R



MA351R

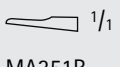

MA351R



MA358R



MA358R

**BARRAQUER Micro Needle Holder,
Round Knurled Handle W/ Catch**

Catalog Number	Tip	Length (in.)
FD232R	STR	4 3/4
MA351R	STR	5 1/4
FD233R	CVD	4 3/4
MA358R	CVD	5 1/4

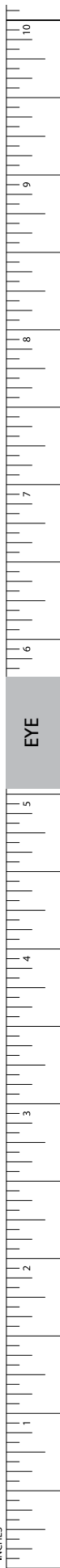

Eye

Micro Needle Holders

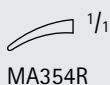
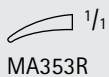

COHEN Micro Needle Holder, Round Knurled Handle

Catalog Number	Tip	Handle	Length (in.)
MA353R	CVD	W/O CATCH	4 1/8
MA354R	CVD	W/ CATCH	4 1/8

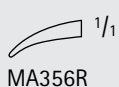
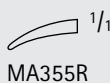

TROUTMAN Micro Needle Holder, Flat Handle W/ Catch

Catalog Number	Tip	Length (in.)
MA355R	CVD	4 3/4
MA356R	CVD	5 1/8

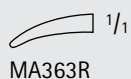
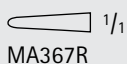
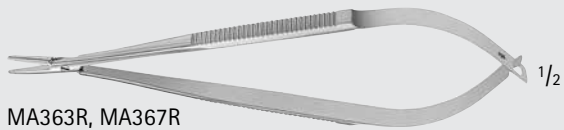
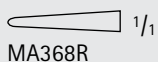
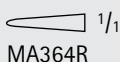

CASTROVIEJO Micro Needle Holder, Flat Handle

Catalog Number	Tip	Jaw Length (mm)	Handle	Length (in.)
MA365R	STR	9	W/ CATCH	5 1/2
MA366R	STR	9	W/ CATCH	5 1/8
MA368R	STR	16	W/ CATCH	5 7/8
MA364R	STR	10	W/ CATCH	5 3/8
MA367R	STR	10	W/O CATCH	5 3/8
MA363R	CVD	10	W/O CATCH	5 3/8



Micro Needle Holder, Round Knurled Handle W/O Catch

Catalog Number	Tip	Length (in.)
MA628R	DEL, CVD	4 3/4

EYE



FD242R-FD243R

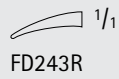
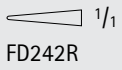

Micro Needle Holder, Round Knurled Handle W/ Catch

Catalog Number	Tip	Length (in.)
FD242R	STR	6
FD243R	CVD	6



MA907R



HAMPTON Micro Needle Holder, Heavy Jaw, Round Knurled Handle W/ Catch

Catalog Number	Tip	Length (in.)
MA907R	CVD	5 1/8



MA908R, MA911R

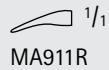
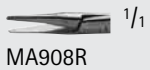

MA909R-MA910R

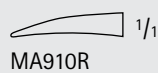
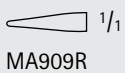

MCPHERSON Micro Needle Holder, Flat Handle, Delicate

Catalog Number	Tip	Handle	Length (in.)
MA908R	STR	SERR W/ CATCH	4 1/4
MA909R	STR	FENESTRATED W/O CATCH	4 1/4
MA911R	CVD	SERR W/O CATCH	4 1/8
MA910R	CVD	FENESTRATED W/ CATCH	4 1/8



INCHES

Eye Forceps

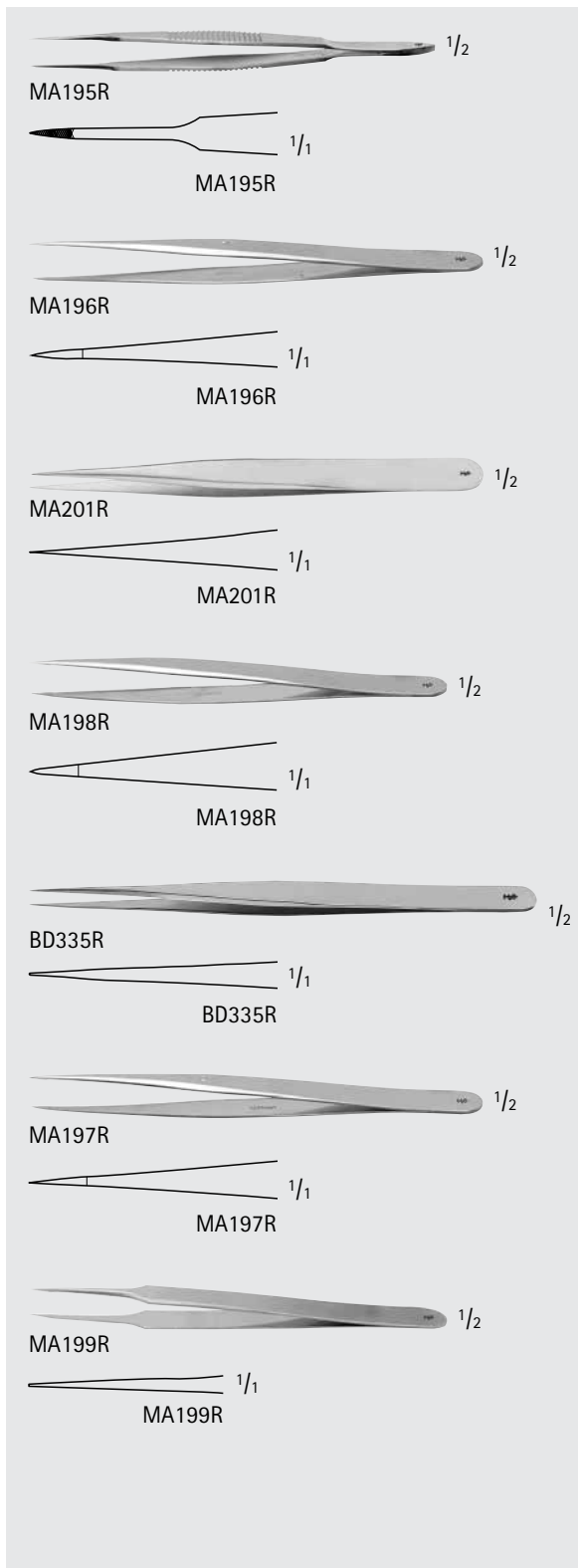

Micro Jewelers Forceps

Catalog Number	Tip	Tip Size (mm)	Tip Size (#)	Length (in.)
MA195R	STR, W/ PLATFORM, X-SERR	3	-	4 1/4
MA196R	STR, FINE, W/ PLATFORM	6	1	4 3/4
MA201R	STR, FINE	-	1	4 3/4
MA198R	STR, X-FINE, W/ PLATFORM	5	3	4 3/8
BD335R	STR	0.3	3	5 1/4
MA197R	STR, X-FINE, W/ PLATFORM	5	3	4 3/4
MA199R	STR, X-FINE, W/ PLATFORM	6	4	4 3/8
BD330R	STR	0.2	4	4 1/4
MA200R	STR, X-FINE, W/ PLATFORM	6	5	4 3/8
BD331R	STR	0.15	5	4 1/4
BD333R	CVD	0.20	5	4 1/2

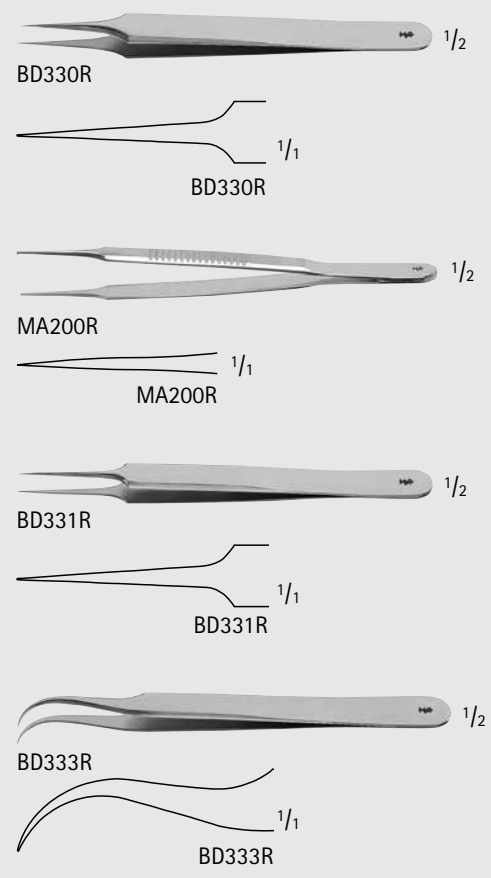



Micro Forceps

Catalog Number	Tip	Jaw	Length (in.)
BD320R	STR	SMOOTH	4
BD321R	ANG	SMOOTH	4

BARRAQUER Cilia Forceps

Catalog Number	Tip	Tip Size (mm)	Length (in.)
MA893R	SLIGHT-ANG	6	4 1/9

WISE Micro Suture Forceps W/ Platform

Catalog Number	Tip	Tip Size (mm)	Length (in.)
BD336R	STR	0.3	5 1/4
BD337R	CVD	0.3	5 1/4

Iris Forceps, Delicate

Catalog Number	Tip	Jaw	Length (in.)
OC020R	STR	SERR	4
OC021R	CVD	SERR	4
OC022R	HEAVY-CVD	SERR	4

Iris Forceps, X-Fine

Catalog Number	Tip	Teeth	Length (in.)
OC024R	STR	1 x 2	4
OC025R	CVD	1 x 2	4
OC026R	HEAVY-CVD	1 x 2	4

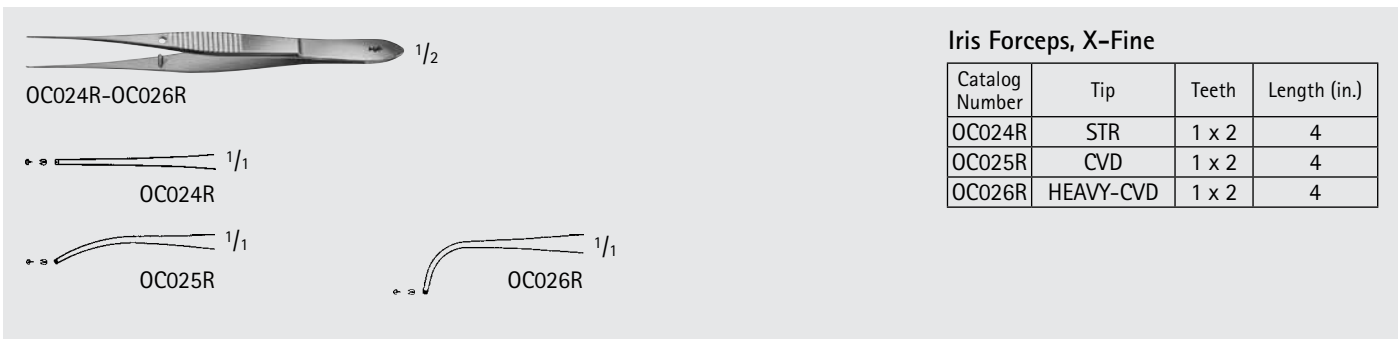
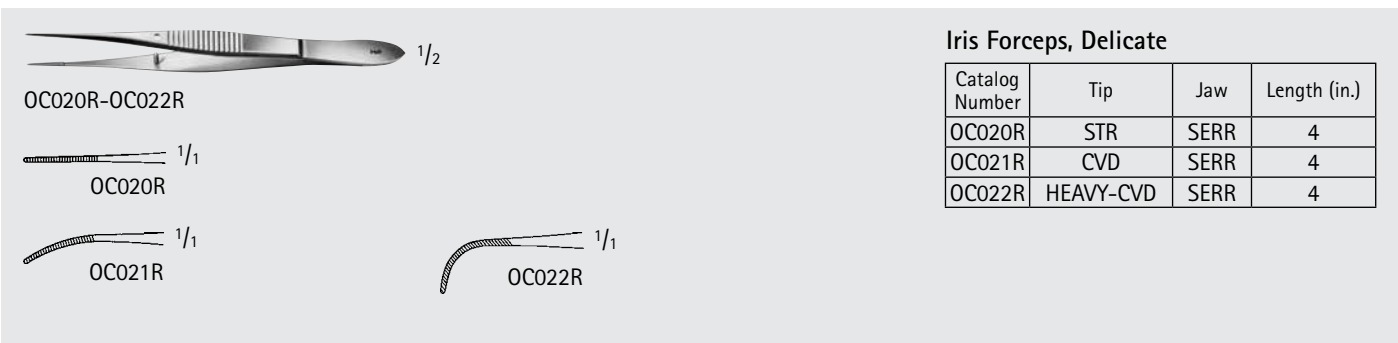
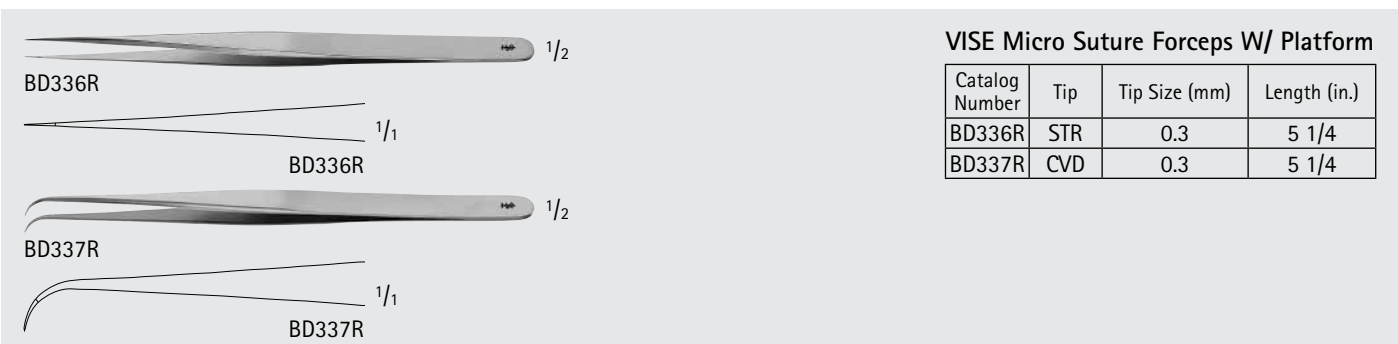
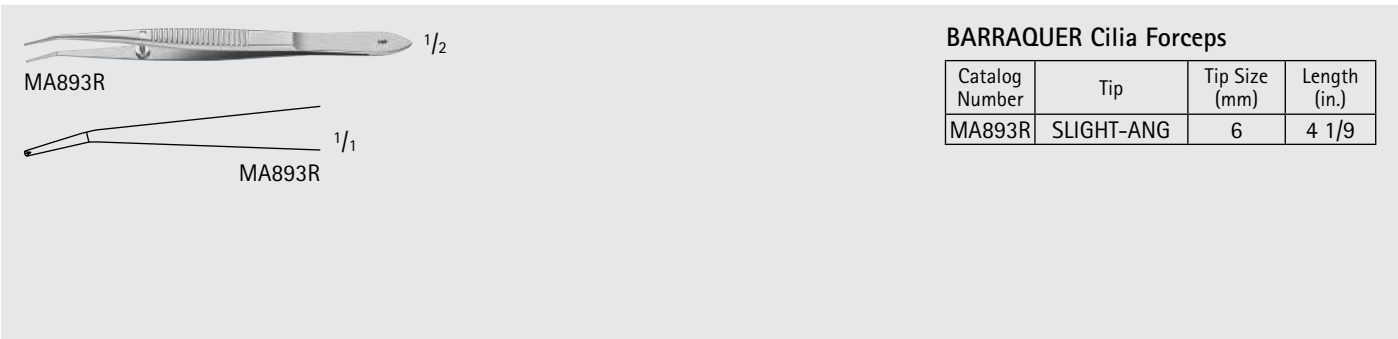
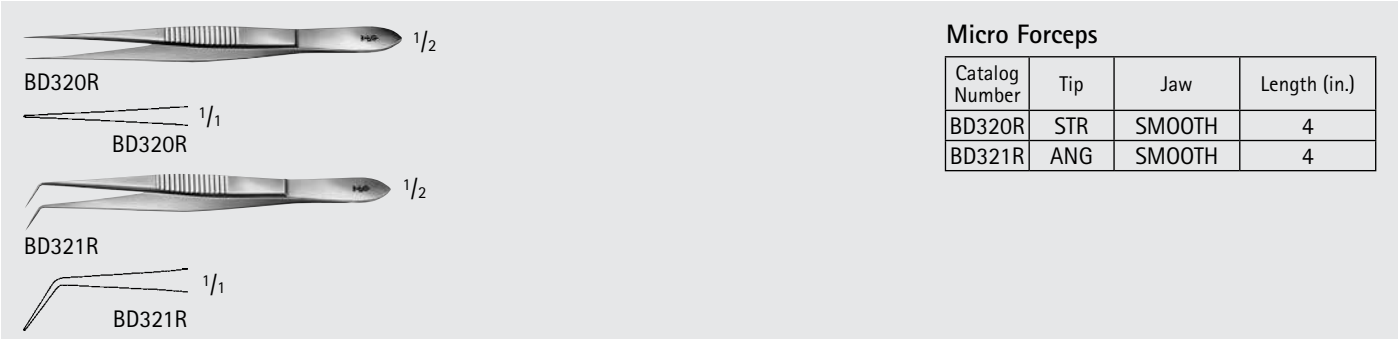

Eye Forceps

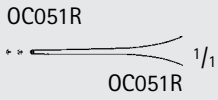

BISHOP-HARMON Iris Forceps

Catalog Number	Teeth	Jaw	Length (in.)
OC051R	1 x 2	-	3 1/4
MD580	-	SERR	3 1/2

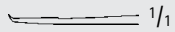
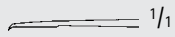
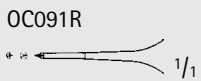

OC091R

ST. MARTIN Tissue Forceps, Delicate

Catalog Number	Teeth	Length (in.)
OC091R	1 x 2	3 1/8

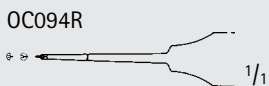

OC094R

CASTROVIEJO Tissue Forceps, Delicate

Catalog Number	Tip Size (mm)	Teeth	Length (in.)
OC094R	0.9	1 x 2	4



US133

CASTROVIEJO Fixation Forceps, W/O Platform

Catalog Number	Tip Size (mm)	Teeth	Length (in.)
US133	0.5	1 x 2	4 1/4

EYE

MILLIMETERS

CASTROVIEJO Suture Forceps,
W/ 1 x 2 Teeth

Catalog Number	Tip	Tip Size (mm)	Platform	Handle	Length (in.)
MB295R	STR	0.12	YES	SERR	4 1/8
MA153R	STR	0.12	YES	SERR	4 3/8
MA152R	STR	0.22	YES	SERR	4 1/4
MA158R	STR	0.3	YES	SERR	4 1/8
MB477R	STR	0.3	YES	SERR	4 3/8
MA148R	STR	0.5	YES	WIDE	4 1/4
MA150R	STR	0.5	YES	SERR	4 1/4
US136	STR	0.5	NO	WIDE W/ LOCK	4 1/4
MA151R	STR	0.9	YES	SERR	4 1/4
MA149R	STR	1.5	YES	WIDE	4 1/4
MA154R	ANG 45°	0.5	YES	SERR	4 1/4

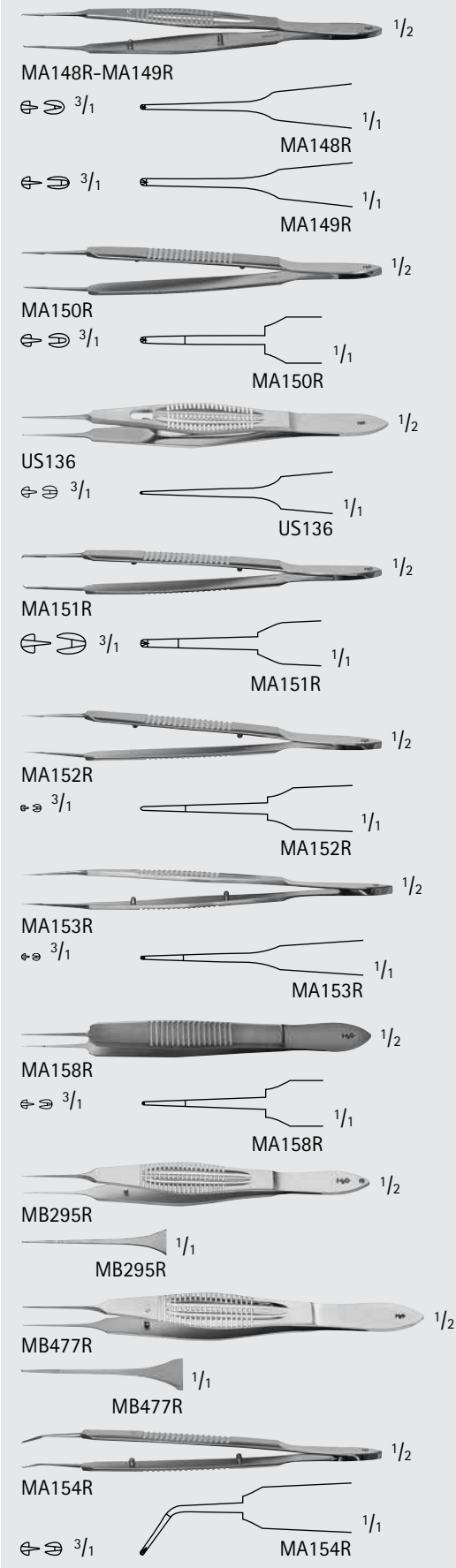

Eye Forceps



MA618R

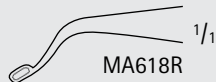

MA618R

CASTROVIEJO Capsule Forceps, Cross-Action

Catalog Number	Tip	Length (in.)
MA618R	10 MM FROM ANGLE TO TIP	4 1/8



MB294R



MB294R

CASTROVIEJO Colibri Type Corneal Forceps

Catalog Number	Tip Size (mm)	Teeth	Length (in.)
MB294R	0.12	1 x 2	4 1/8



BD505R

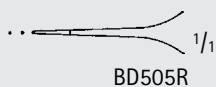

BD505R

BONN Eye Forceps, W/ Platform

Catalog Number	Tip Size (mm)	Teeth	Length (in.)
BD505R	0.2	1 x 2	3 3/4



OC100R

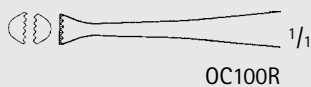

OC100R

GRAEFE Tissue Forceps

Catalog Number	Length (in.)
OC100R	4 1/4



FD280R-FD281R

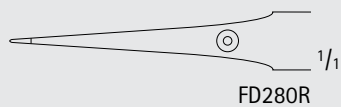

FD280R

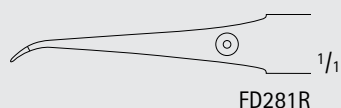

FD281R

Suture Tying Forceps, W/ Platform

Catalog Number	Tip	Tip Size (mm)	Length (in.)
FD280R	STR	0.3	4 3/4
FD281R	CVD	0.3	4 3/4



MA875R

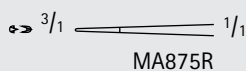

MA875R

OSHER-ELSCHNIG Forceps, W/ Platform

Catalog Number	Tip	Tip Size (mm)	Teeth	Length (in.)
MA875R	0.12	3	1 x 2	4 1/8



MA160R-MA161R



MA160R-MA161R

BONACCOLTO Utility Forceps

Catalog Number	Tip Size (mm)	Length (in.)
MA160R	1.2 x 16	4 1/4
MA161R	1.7 x 17	4 1/4



MA876R

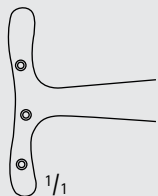

MA876R

PUTTERMAN-Type Muscle Forceps, W/ Lock

Catalog Number	Tip	Jaw	Length (in.)
MA876R	6 PINS	SERR	4



MA886R



MA886R

TENNANT Tying Forceps, W/ Platform

Catalog Number	Tip	Tip Size (mm)	Jaw	Handle	Length (in.)
MA886R	X-DEL	6	SMOOTH	ROUND	4 1/4



MA885R



MA885R

SINSKEY Tying Forceps

Catalog Number	Tip	Jaw	Handle	Length (in.)
MA885R	X-DEL	SMOOTH, CVD	FLAT, WIDE SERR	4



EYE

INCHES

Eye Forceps

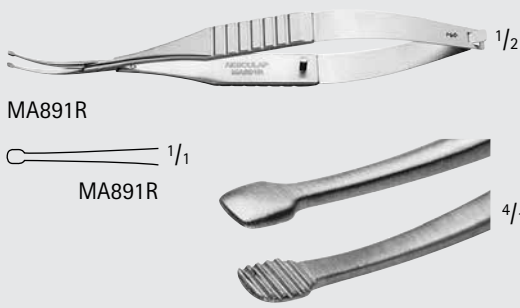

**SHEPARD Lens Holding Forceps,
Cross-Action**

Catalog Number	Tip	Jaw	Handle	Length (in.)
MA891R	DUCKBILL	CVD	FLAT, WIDE SERR	5



**CLAYMAN Lens Holding Forceps,
Cross-Action**

Catalog Number	Tip	Jaw	Handle	Length (in.)
MA892R	DEL, ANG	CVD	FLAT, WIDE SERR	4 3/4

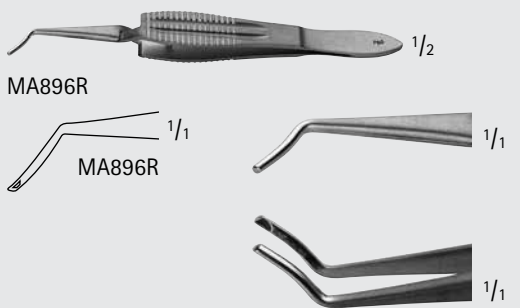

Scleral Plug Forceps, Cross-Action

Catalog Number	Tip	Tip Size (mm)	Jaw	Handle	Length (in.)
MA896R	CVD	9	ANG	FLAT, SERR	4 1/8

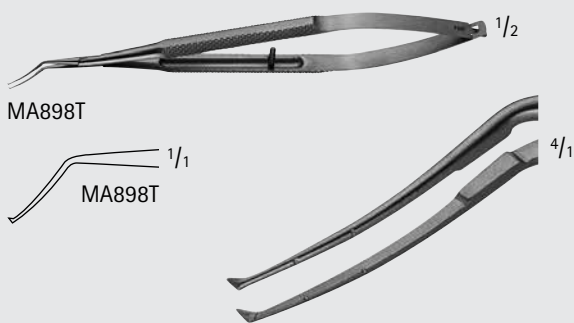

**DEVGAN Titanium Capsulorhexis
Forceps, Cross-Action**

Catalog Number	Tip	Handle	Length (in.)
MA898T	X-DEL, SEMI-SHARP	ROUND	5

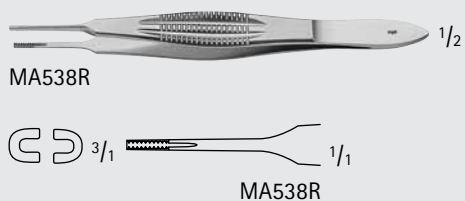

GRIFFITHS-BROWN Tissue Forceps

Catalog Number	Tip	Length (in.)
MA538R	DEL	4 1/4

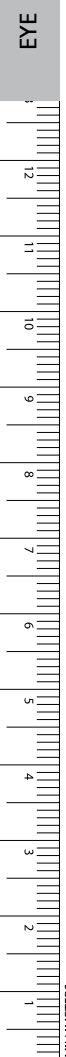

BONN Suture Forceps, W/ Platform

Catalog Number	Tip Size (mm)	Teeth	Length (in.)
MA155R	0.12	1 x 2	3 3/4

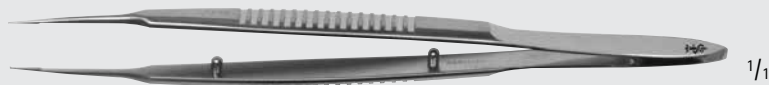

MA155R

1/1

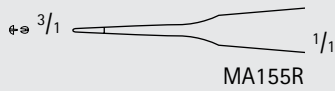

MA155R

BONN Tissue Forceps

Catalog Number	Tip Size (mm)	Teeth	Length (in.)
MA878R	0.12	1 x 2	3 3/4



MA878R

1/1

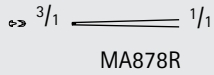

MA878R

THORPE Conjunctival Fixation Forceps, W/ Platform

Catalog Number	Teeth	Length (in.)
MA157R	2 x 3	3 3/4



MA157R

1/1

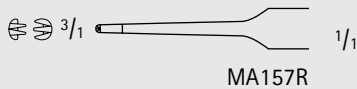

MA157R

THORPE Corneal Forceps W/ Platform

Catalog Number	Tip Size (mm)	Jaw	Teeth	Length (in.)
MA901R	0.12	STR	2 x 3, ANG 45°	3 3/4



MA901R

1/1

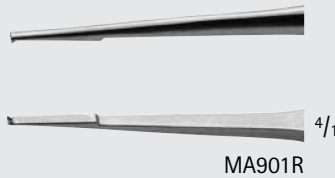

MA901R

LESTER Fixation Forceps

Catalog Number	Teeth	Length (in.)
MA166R	FINE, 1 x 2	3 3/4
MA167R	FINE, 2 x 3	3 3/4



MA166R-MA167R

1/1

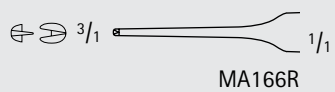

MA166R

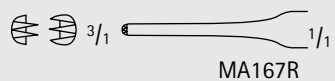

MA167R



EYE

INCHES

Eye Forceps



MA170R-MA171R

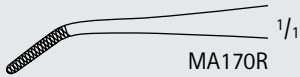

MA170R

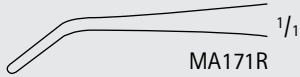

MA171R

NUGENT Utility Forceps

Catalog Number	Jaw	Jaw Length (mm)	Length (in.)
MA170R	SERR, ANG 45°	10	4 1/4
MA171R	SMOOTH, ANG 45°	10	4 1/4



MA902R

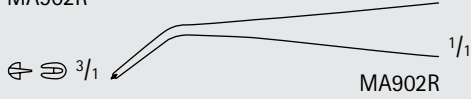

MA902R

TROUTMAN Superior Rectus Forceps

Catalog Number	Tip Size (mm)	Jaw	Teeth	Length (in.)
MA902R	10	ANG	1 x 2	4 1/8



MA316R-MA317R



MA316R-MA317R

BERKE Ptosis Forceps, W/ Lock

Catalog Number	Jaw Length (mm)	Length (in.)
MA316R	20	4
MA317R	27	4 1/8



MA548R

Serrefine Clamp

Catalog Number	Tip	Jaw	Jaw Length (mm)	Length (in.)
MA548R	STR	SERR	10	1 3/8



MA881R

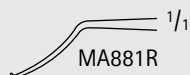

MA881R



4/1

LEHNER-UTRATA Capsulotomy Forceps

Catalog Number	Tip	Tip Size (mm)	Length (in.)
MA881R	ANG	12	3 1/2

EYE



UTRATA Capsulorhexis Forceps

Catalog Number	Tip	Tip Size (mm)	Handle	Length (in.)
MA617R	ANG	12	FLAT, SERR	3 1/8
MG363R	ANG	11	FLAT, FENESTRATED	4

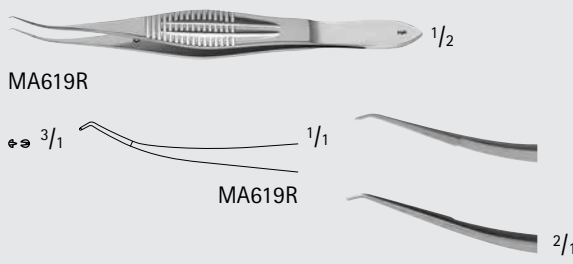

COLIBRI-Style Corneal Forceps, W/ Platform

Catalog Number	Tip	Tip Size (mm)	Teeth	Length (in.)
MA619R	ANG 50°	6	1 x 2	4 1/4



TROUTMAN-BARRAQUER Corneal Forceps

Catalog Number	Tip Size (mm)	Teeth	Length (in.)
MA620R	0.12	1 x 2	2 7/8

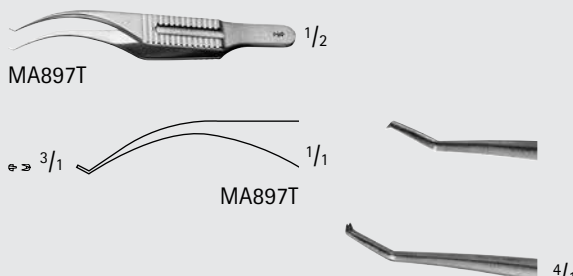

Titanium COLIBRI Forceps

Catalog Number	Tip Size (mm)	Jaw	Teeth	Length (in.)
MA897T	0.12	SMOOTH	1 x 2	3



MCPHERSON Angled Corneal Suturing Forceps, W/ Platform

Catalog Number	Tip	Tip Size (mm)	Teeth	Length (in.)
MA621R	ANG 45°	5	1 x 2	3 3/8



EYE

INCHES

Eye Forceps



BRACKEN Iris Forceps

Catalog Number	Tip	Jaw	Length (in.)
MA622R	CVD	CROSS-SERR	3 7/8

KELMAN-MCPHERSON Forceps, W/ Platform

Catalog Number	Tip	Tip Size (mm)	Length (in.)
MA624R	ANG 45°	8.5	3 3/8

MCPHERSON Forceps, W/ Platform

Catalog Number	Tip	Tip Size (mm)	Length (in.)
MA625R	STR	5	3 1/4

BECHERT-MCPHERSON Forceps

Catalog Number	Tip	Tip Size (mm)	Jaw	Length (in.)
MA879R	ANG	10	SMOOTH	3 1/4

SHEETS-MCPHERSON Forceps

Catalog Number	Tip	Tip Size (mm)	Jaw	Length (in.)
MA880R	1 MM X-SERR	10	ANG	3 1/4



MA626R



MA626R



MA726R



MA726R

JAMESON Muscle Forceps, W/ Lock

Catalog Number	Tip Size (mm)	Jaw	Length (in.)
MA626R	12	ANG, LEFT	3 3/8
MA726R	12	ANG, RIGHT	4



MA623R

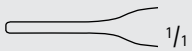

MA623R

MCCULLOUGH Utility Forceps

Catalog Number	Tip	Tip Size (mm)	Jaw	Length (in.)
MA623R	STR	15	SMOOTH	3 5/8



MA899R



MA899R

Tying Forceps

Catalog Number	Jaw	Handle	Length (in.)
MA899R	SMOOTH	FLAT, SERR	4 1/4



MA900R



MA900R

Alabama University Forceps, W/ Platform

Catalog Number	Tip	Tip Size (mm)	Length (in.)
MA900R	V-GROOVED	15	3 1/2



INCHES

Eye Forceps



MA882R

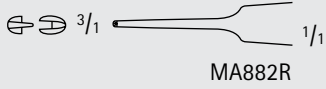

MA882R

Von GRAEFE Iris Forceps

Catalog Number	Tip	Teeth	Length (in.)
MA882R	STR	1 x 2	3



MA883R

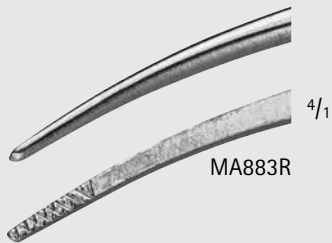

MA883R

GILL Iris Forceps

Catalog Number	Tip	Jaw	Length (in.)
MA883R	CVD	CROSS-SERR	3



MA877R

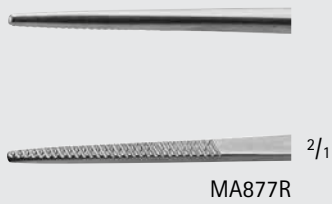

MA877R

WILLS Hospital Utility Forceps

Catalog Number	Tip	Jaw	Length (in.)
MA877R	STR	SERR	4



MA884R



MA884R

WATZKE Sleeve Spreading Forceps

Catalog Number	Tip	Jaw Length (mm)	Length (in.)
MA884R	ANG	10	4 3/4

EYE

BARRAQUER Eye Speculum

Catalog Number	Blade Size (mm)	Frame	Length (in.)
MA751R	10	WIRE	1 1/2
OA200R	10	WIRE	1 3/4
MA752R	14	HEAVY WIRE	1 3/4
MA754R	15	SOLID	1 3/4

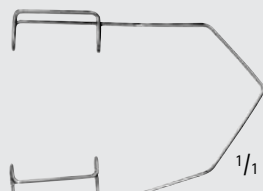

OA200R

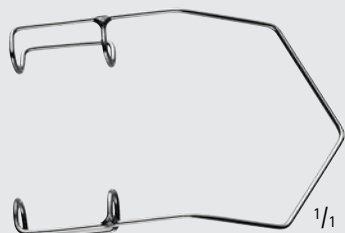

MA752R



MA754R

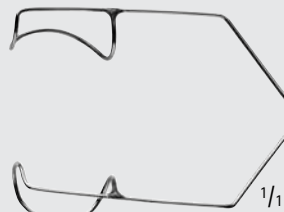

MA751R

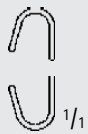

KRATZ-BARRAQUER Eye Speculum

Catalog Number	Blade Size (mm)	Blade Shape	Length (in.)
MA756R	10	PEDIATRIC	1 3/8
MA755R	14	ADULT	1 1/2

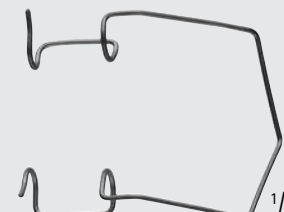

MA756R

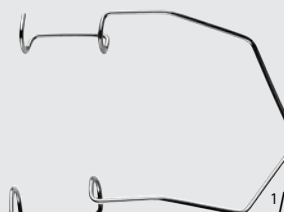

MA755R



INCHES

Eye Specula



MA757R

ALPHONSO Speculum, Infant

Catalog Number	Blade Size (mm)	Length (in.)
MA757R	7 x 5 AND 9 WIDE	1 3/4



MA750R



MA758R



MA759R



MA760R



MA764R

LIEBERMAN Speculum, Adjustable

Catalog Number	Blade Size (mm)	Blade Shape	Length (in.)
MA750R	16	STR, SQUARE WIRE	3 1/8
MA758R	14	ANG, SQUARE WIRE	3 1/4
MA759R	14	ANG, V-SHAPE WIRE	3 1/4
MA760R	14	ANG, SOLID	3 1/4
MA764R	14	ANG, REVERSIBLE, SOLID	3 1/8



MA763R



MA762R

JAFFE Wire Lid Retractor, Pair

Catalog Number	Blade Size (mm)	Length (in.)
MA763R	13	1 1/2
MA762R	15	1 1/2

EYE



OA218R

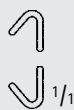

OA218R

SAUER Eye Speculum

Catalog Number	Length (in.)
OA218R	1 3/8



MA638R



MA638R



OA225R

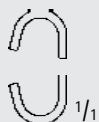

OA225R

LANCASTER Eye Speculum

Catalog Number	Length (in.)
MA638R	2 3/4
OA225R	3 1/8

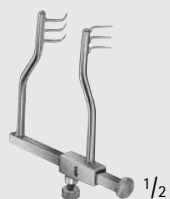

BV013R



BV013R

LOGAN Modified REILL Self-Retaining Retractor

Catalog Number	Length (in.)
BV013R	2



INCHES

Eye

Hooks and Retractors



MA434R-MA437R

SEWALL Orbital Retractor

Catalog Number	Blade Size (mm)	Length (in.)
MA434R	7 x 52	6 3/4
MA435R	9 x 44	6 3/8
MA436R	11 x 50	6 3/8
MA437R	13 x 67	6 3/4

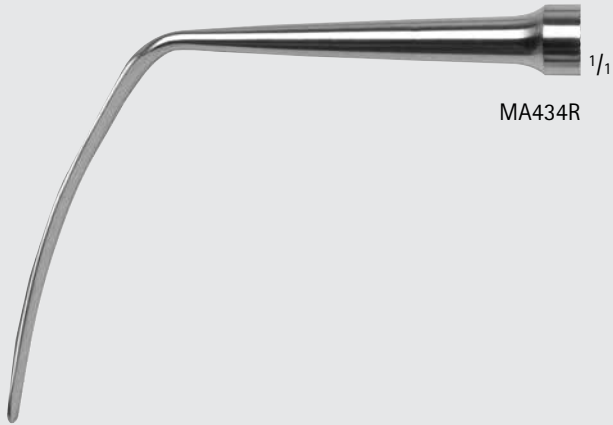

MA434R



MA435R



MA436R



MA437R





OA310R-OA314R

DESMARRES Lid Retractor

Catalog Number	Blade Size (mm)	Length (in.)
OA310R	9 x 9	5 1/2
OA311R	9 x 12	5 1/2
OA312R	11 x 14	5 1/2
OA313R	12 x 16	5 1/2
OA314R	13 x 18	5 1/2



OA310R



OA311R



OA312R



OA313R



OA314R

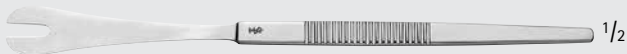

MA749R

SCHEPENS Orbital Retractor

Catalog Number	Tip	Blade Size (mm)	Length (in.)
MA749R	SMOOTH	14 x 61	6 1/8



MA765

JAEGER Lid Plate, Clear Plastic

Catalog Number	Blade Size (mm)	Length (in.)
MA765	20/23	3 3/4



Eye

Hooks / Retractors / Manipulators



MA766R

BERKE-JAEGER Lid Plate

Catalog Number	Blade Size (mm)	Length (in.)
MA766R	20/30	4 1/4



MA731R

WELLS Enucleation Spoon

Catalog Number	Diameter (mm)	Length (in.)
MA731R	21	5 3/4



MA744R-MA745R



MA744R



MA745R

BUNGE Evisceration Spoon

Catalog Number	Tip	Diameter (mm)	Length (in.)
MA744R	SMALL	8	5 1/4
MA745R	LARGE	12	5 1/2



MA761R

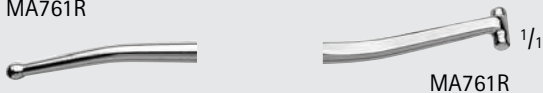

MA761R

SCHOCKET Scleral Depressor, Double Ended

Catalog Number	Length (in.)
MA761R	5 1/4



MA747R



MA747R

FLYNN Scleral Depressor

Catalog Number	Diameter (mm)	Length (in.)
MA747R	5	3 1/8

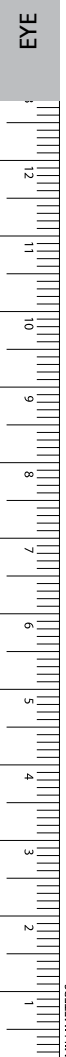

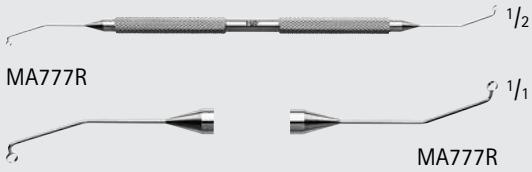

WHITMAN-SHEPHERD Capsule Polisher, Double Ended

Catalog Number	Tip	Length (in.)
MA777R	LEFT ANG, RIGHT ANG	5 1/8

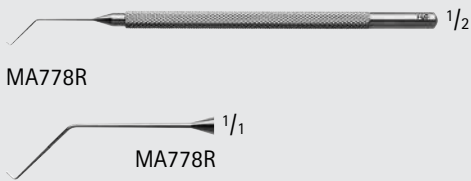

KOCH Stop and Chop Manipulator, Angled Shaft

Catalog Number	Tip Size (mm)	Length (in.)
MA778R	1.5	4 3/4

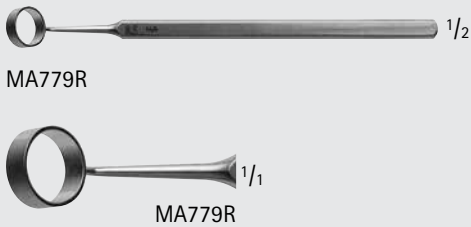

CAMELLIN Style LASIK Alcohol Well

Catalog Number	Diameter (mm)	Length (in.)
MA779R	8.5	4 1/2

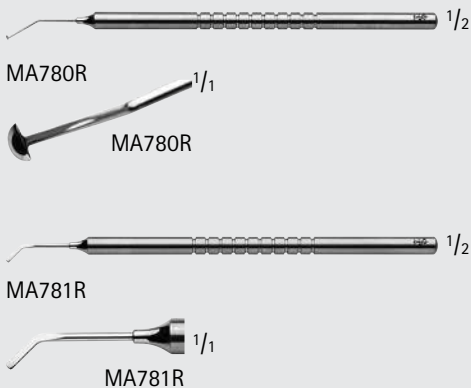

SLOANE LASIK Spatula

Catalog Number	Tip	Description	Length (in.)
MA780R	SEMI-CIRCULAR, BEVELED EDGE	MICRO HOE	4 1/2
MA781R	SEMI-SHARP	EPI PEELER	4 1/2



Eye

Hooks / Retractors / Manipulators

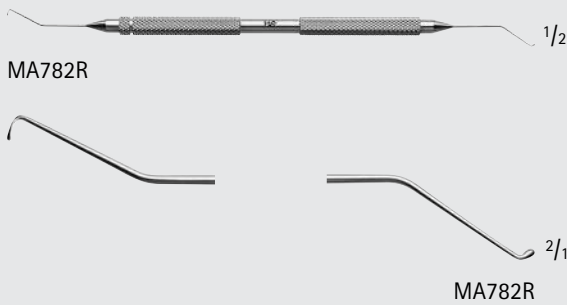

CHANG-SEIBEL Phaco Chopper, Double Ended

Catalog Number	Tip	Style	Length (in.)
MA782R	ANG C-SHAPED BLUNT CHOPPER / VERTICAL SAFETY CHOPPER	F/ LEFT HAND	5 1/2

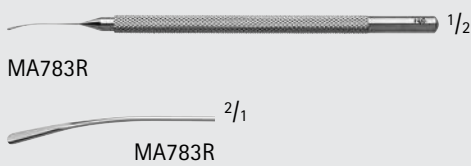

KOCH Nucleus Spatula

Catalog Number	Tip	Tip Size (mm)	Length (in.)
MA783R	SLIGHTLY CVD W/ DUCKBILL TIP	1	4 1/2

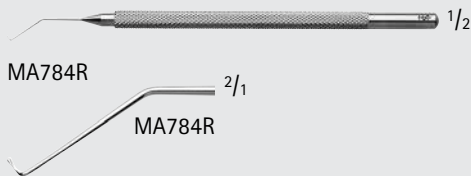

LIEBERMAN Nucleus Manipulator

Catalog Number	Style	Shaft	Length (in.)
MA784R	F/ LEFT HAND	ANG	4 1/2

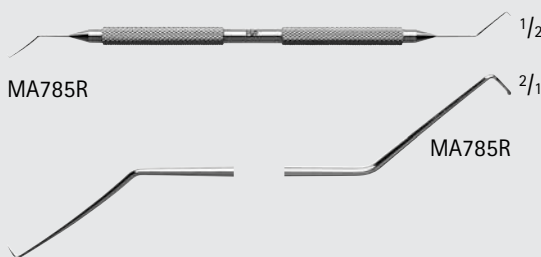

CHANG Combo Phaco Chopper, Double Ended

Catalog Number	Tip	Style	Shaft	Length (in.)
MA785R	C-SHAPED BLUNT CHOPPER / 1.3 MM SHARP QUICK CHOP TIP	F/ LEFT HAND	ANG	5 1/4

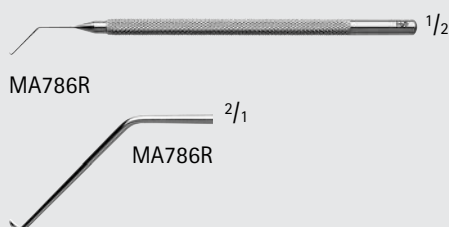

NAGAHARA Nucleus Spatula

Catalog Number	Tip	Style	Shaft	Length (in.)
MA786R	FLAT INTERIOR EDGE	F/ LEFT HAND	ANG	4 1/4

EYE

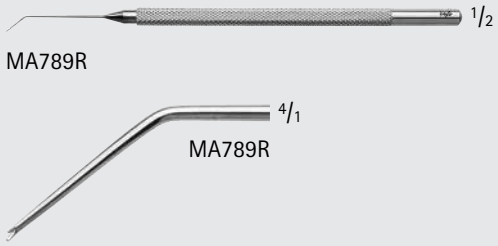

BECHERT Nucleus Rotator

Catalog Number	Tip	Shaft	Length (in.)
MA789R	Y-SHAPED	ANG 45° 7 MM FROM TIP	4 3/4

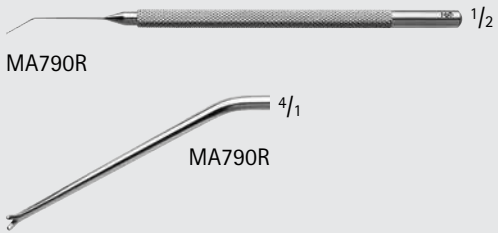

JAFFE-BECHERT Nucleus Rotator

Catalog Number	Tip	Shaft	Length (in.)
MA790R	Y-SHAPED	ANG 45° 9 MM FROM TIP	4 3/4

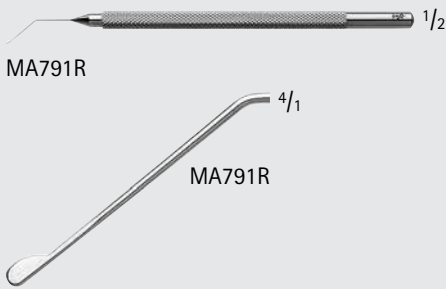

DRYSDALE Nucleus Manipulator

Catalog Number	Tip	Length (in.)
MA791R	PADDLE-SHAPED	4 1/4

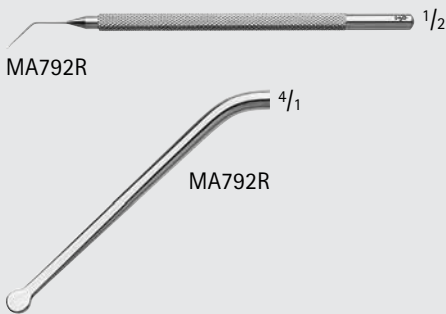

PISACANO Nucleus Rotator

Catalog Number	Tip	Length (in.)
MA792R	VERTICAL FLAT	4 1/4

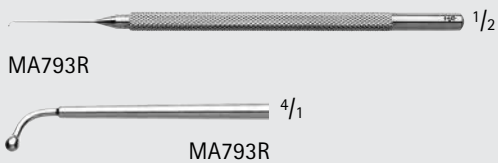

ANIS-WAND Nucleus Manipulator

Catalog Number	Tip	Tip Size (mm)	Shaft	Length (in.)
MA793R	BALL-SHAPED	0.5	STR	4 3/4



Eye

Hooks / Retractors / Manipulators

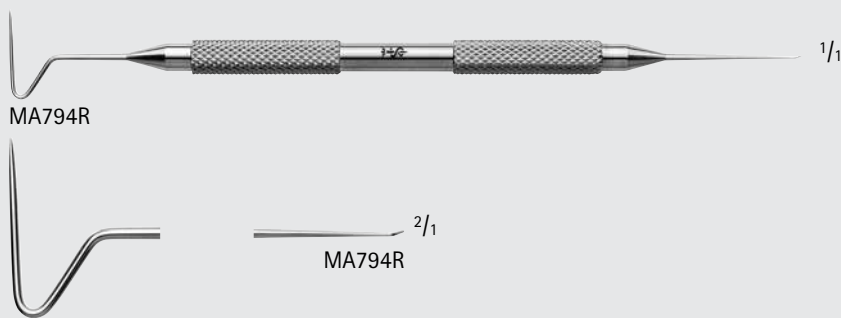

SIEBEL Flap Lifter and Spatula, Double Ended

Catalog Number	Tip	Length (in.)
MA794R	Z-SHAPED AND 1.5 MM ANG POINT	4 1/8

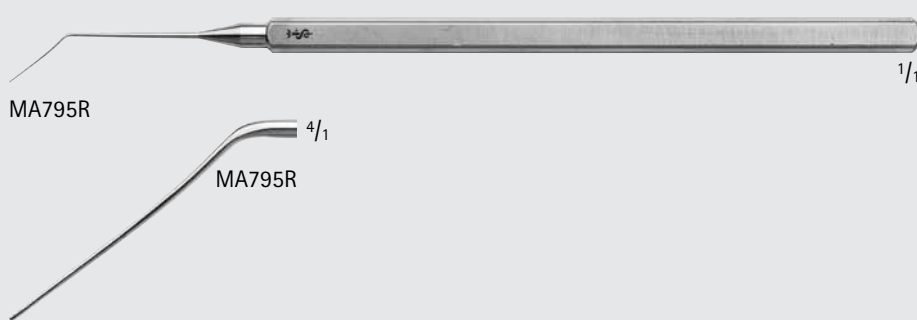

JAFFE Lens Spatula

Catalog Number	Tip	Tip Size (mm)	Length (in.)
MA795R	FLAT	0.5	4 3/4

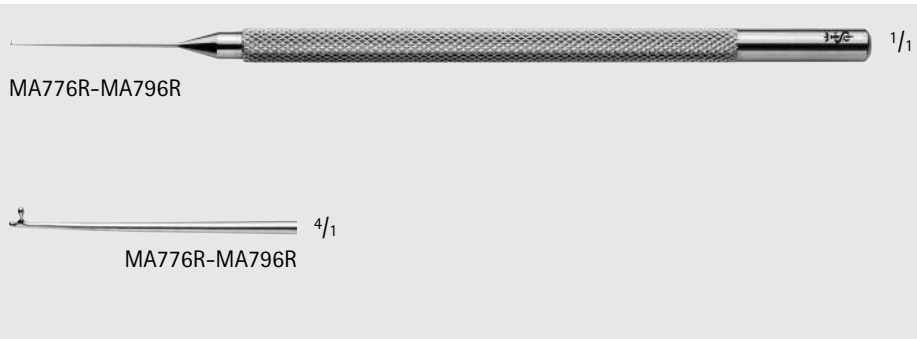

LESTER IOL Manipulator

Catalog Number	Tip	Tip Size (mm)	Shaft	Length (in.)
MA776R	TEARDROP-SHAPED	0.25	STR	4 1/2
MA796R	TEARDROP-SHAPED	0.25	ANG	4 1/2

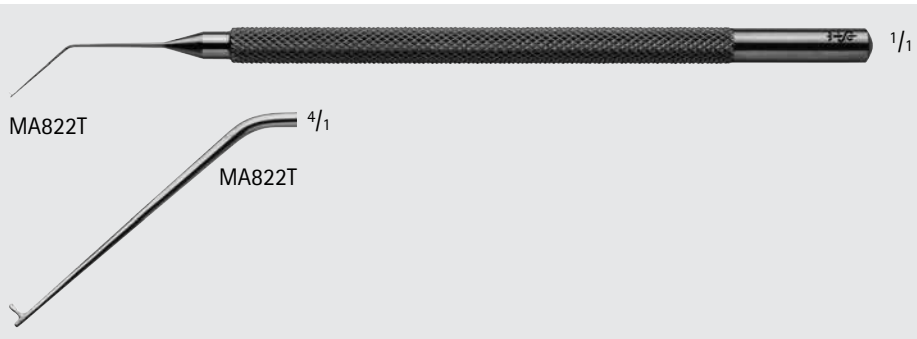

LESTER II Titanium IOL Manipulator

Catalog Number	Tip	Tip Size (mm)	Shaft	Length (in.)
MA822T	TEARDROP-SHAPED	0.20	ANG	4 1/2

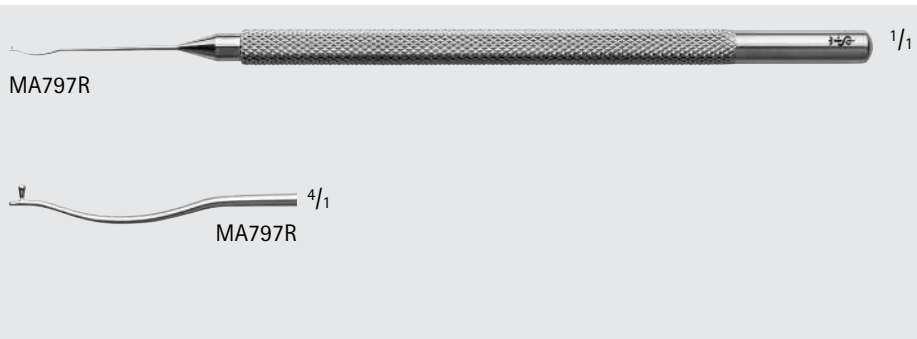

MALONEY IOL Manipulator

Catalog Number	Tip	Tip Size (mm)	Shaft	Length (in.)
MA797R	TEARDROP-SHAPED	0.25	CVD	4 1/2

1
2
3
4
5
6
7
8
9
10
11
12
13
14
15
16
17
18
19
20
21
22
23
24
25



MA637R



MA637R

BARRAQUER Cyclodialysis Spatula

Catalog Number	Blade Size (mm)	Blade	Length (in.)
MA637R	0.5 x 15	ANG	4 7/8

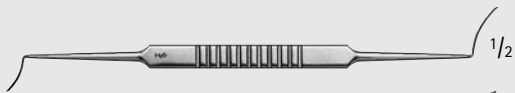

MA799R



MA799R

CASTROVIEJO Cyclodialysis Spatula, Double Ended

Catalog Number	Blade Size (mm)	Length (in.)
MA799R	0.5 x 10 / 0.5 x 15	5 1/8



MA798R

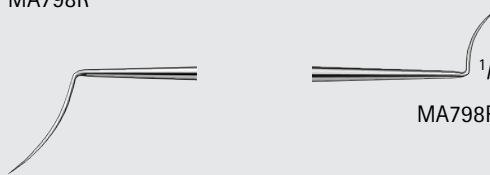

MA798R

CASTROVIEJO Synechia Spatula, Double Ended

Catalog Number	Blade Size (mm)	Length (in.)
MA798R	0.5	5 1/4

MA798R



MA823R



MA823R

NEW ORLEANS Lens Loop

Catalog Number	Tip	Length (in.)
MA823R	4 x 10	5 1/2



MA801R

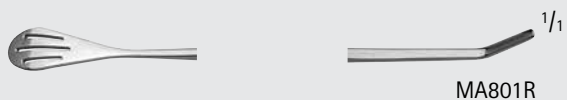

MA801R

PATON Spatula and Spoon, Double Ended

Catalog Number	Tip	Length (in.)
MA801R	6 MM WIDE GROOVED SPOON / 1.5 MM FLAT BLADE ANG AT 8 MM	5 1/2



INCHES

Eye

Hooks / Retractors / Manipulators



MA803R

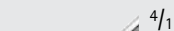

MA803R

GRAETHER Collar Button

Catalog Number	Tip	Shaft	Length (in.)
MA803R	0.6 MM BUTTON	ANG 45° 10 MM FROM TIP	4 3/4



MA805R

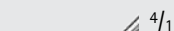

MA805R

CLAYMAN-JAFFE Lens Hook

Catalog Number	Tip	Tip Size (mm)	Shaft	Length (in.)
MA805R	ANG 90° BLUNT	0.15	ANG 45° 10 MM FROM TIP	4 1/2



MA806R

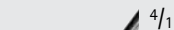

MA806R

HARRS-SINSKEY Lens Manipulating Hook

Catalog Number	Tip	Tip Size (mm)	Shaft	Handle	Length (in.)
MA806R	BLUNT	0.25	ANG 45° 10 MM FROM TIP	FLAT	4 1/2



MA630R



MA630R



MA824R

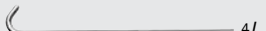

MA824R

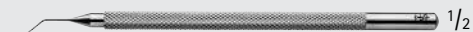

MA804R

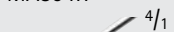

MA804R



MA807R



MA807R



MA808R

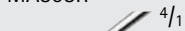

MA808R

SINSKEY Lens Manipulating Hook

Catalog Number	Tip	Tip Size (mm)	Shaft	Handle	Length (in.)
MA630R	BLUNT	0.25	STR	FLAT	4 5/8
MA824R	BLUNT	0.20	MODIFIED CVD	FLAT	4 1/2
MA804R	BLUNT, REVERSE	0.20	ANG	FLAT	4 1/2
MA807R	BLUNT	0.25	STR	ROUND	4 1/2
MA808R	BLUNT	0.25	ANG	ROUND	4 1/2

EYE

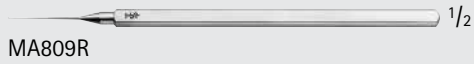

MA809R



MA809R



MA810R



MA810R



MA811R



MA811R



MA812R



MA812R

SINSKEY II Lens Manipulating Hook

Catalog Number	Tip	Tip Size (mm)	Shaft	Handle	Length (in.)
MA809R	BLUNT	0.2	STR	FLAT	4 1/2
MA810R	BLUNT	0.2	ANG	FLAT	4 1/2
MA811R	BLUNT	0.2	STR	ROUND	4 1/2
MA812R	BLUNT	0.2	ANG	ROUND	4 1/2



MA825T



MA825T



MA819T

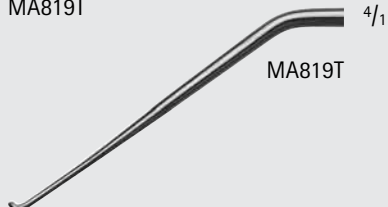

MA819T

SINSKEY II Titanium Lens Manipulating Hook

Catalog Number	Tip	Tip Size (mm)	Shaft	Handle	Length (in.)
MA825T	BLUNT	0.2	STR	FLAT	4 1/2
MA819T	BLUNT	0.2	ANG	ROUND	4 1/2



EYE

INCHES

Eye

Hooks / Retractors / Manipulators

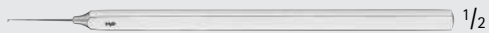

MA631R



MA631R



MA813R-MA814R

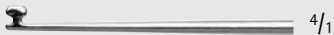

MA813R

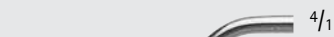

MA814R



MA815R-MA816R



MA815R

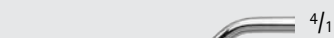

MA816R

KUGLEN Iris Hook and Lens Manipulator

Catalog Number	Tip	Tip Size (mm)	Shaft	Handle	Length (in.)
MA631R	K-HOOK	0.5	STR	SQUARE	4 5/8
MA813R	PUSH-PULL	-	STR	FLAT	4 1/2
MA814R	PUSH-PULL	-	ANG	FLAT	4 1/2
MA815R	PUSH-PULL	-	STR	ROUND	4 1/2
MA816R	PUSH-PULL	-	ANG	ROUND	4 1/2



MA827T



MA827T



MA826T

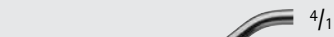

MA826T

KUGLEN Titanium Iris Hook and Lens Manipulator

Catalog Number	Tip	Shaft	Handle	Length (in.)
MA827T	K-HOOK	STR	ROUND	4 1/2
MA826T	PUSH-PULL	ANG	ROUND	4 1/2

EYE

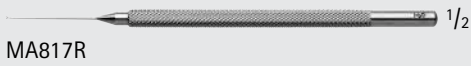

MA817R

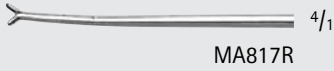

MA817R

OSHER "Y"-Hook Lens Manipulator

Catalog Number	Tip	Shaft	Length (in.)
MA817R	Y-SHAPED	STR	4 1/2



MA818R

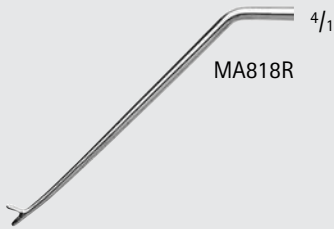

MA818R

JAFFE-MALTZMAN Lens Manipulating Hook

Catalog Number	Tip	Tip Size (mm)	Shaft	Length (in.)
MA818R	V-SHAPED	0.15	ANG	4 1/2



MA775R



MA775R

MCPHERSON Iris Spatula

Catalog Number	Blade Size (mm)	Length (in.)
MA775R	1 x 16	4 1/2



MA820R

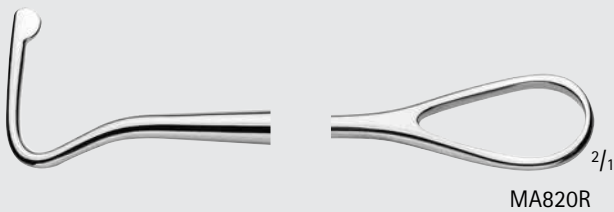

MA820R

KIRBY Hook and Muscle Loop, Double Ended

Catalog Number	Blade Size (mm)	Length (in.)
MA820R	5 x 10	6 1/8

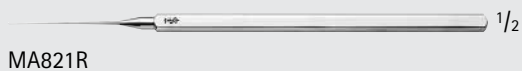

MA821R



MA821R

BONN Micro Iris Hook

Catalog Number	Tip	Shaft	Length (in.)
MA821R	BLUNT	STR	5



INCHES

Eye

Hooks / Retractors / Manipulators



MA632R



MA632R



MA828R



MA828R

JAMESON Muscle Hook

Catalog Number	Size	Tip Size (mm)	Length (in.)
MA632R	SMALL	9	5 1/4
MA828R	LARGE	10	5 1/4



MA633R



MA633R

GREEN Strabismus Hook

Catalog Number	Tip	Tip Size (mm)	Length (in.)
MA633R	FLAT	8	5 1/8



MA634R



MA634R

Twist Fixation Hook

Catalog Number	Tip	Length (in.)
MA634R	RIGHT, CLOCKWISE TWIST	4 1/4

EYE

MILLIMETERS



MA635R



MA635R

GASS Retinal Detachment Hook

Catalog Number	Length (in.)
MA635R	5 5/8



MA636R

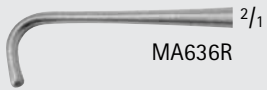

MA636R

STEVENS Tenotomy Hook

Catalog Number	Tip	Tip Size (mm)	Length (in.)
MA636R	CVD, BLUNT	5	4 5/8



MA800R



MA800R

ALFONSO Nucleus Trisector

Catalog Number	Tip Size (mm)	Length (in.)
MA800R	1.5	4 3/4



MA194R



MA194R

TYRELL Iris Hook

Catalog Number	Tip	Tip Size (mm)	Length (in.)
MA194R	SHARP	2	4 3/4



EYE

Eye

Fixation Rings and Markers



MA732R-MA742R

FLIERINGA Scleral Fixation Ring

Catalog Number	Diameter (mm)	Description
MA743R	12-22	SET OF 8 RINGS
MA732R	12	-
MA733R	13	-
MA734R	14	-
MA735R	15	-
MA736R	16	-
MA737R	17	-
MA738R	18	-
MA739R	19	-
MA740R	20	-
MA741R	21	-
MA742R	22	-



MA975R



MA975R

OSHER-NEUMANN Corneal Marker

Catalog Number	Tip	Length (in.)
MA975R	8 BLADES	4 1/8



MA829R



MA829R

THORNTON Swivel Fixation Ring

Catalog Number	Tip	Diameter (mm)	Length (in.)
MA829R	BLUNT TEETH	13	4 1/2

EYE

MILLIMETERS



MA833R



MA833R

MENDEZ Degree Gauge, Calibrated 10° from 0–180°

Catalog Number	Inner Diameter (mm)	Compatible w/	Length (in.)
MA833R	12	MA836R	4 1/4



MA836R



MA836R

BORES Axis Marker

Catalog Number	Compatible w/	Length (in.)
MA836R	MA833R	4



MA834R



MA834R

HENDERSON Degree Gauge

Catalog Number	Tip	Compatible w/	Length (in.)
MA834R	BEVELED FACE, SMOOTH	MA837R	4 1/8

For use with MA837R



MA835R



MA835R

HENDERSON Alignment Marker

Catalog Number	Tip	Compatible w/	Length (in.)
MA835R	BLUNT PIN MARKINGS AT 3, 6 AND 9 O'CLOCK	MA834R AND MA837R	4

For use with MA837R



MA837R



MA837R

HENDERSON Toric IOL Marker

Catalog Number	Tip	Compatible w/	Length (in.)
MA837R	2.5 MM AXIS MARKS	MA834R	4



INCHES

Eye

Fixation Rings and Markers



MA838R-MA841R



MA838R



MA839R



MA840R

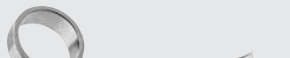

MA841R

BORES Optical Zone Marker

Catalog Number	Inner Diameter (mm)	Length (in.)
MA838R	3.5	4
MA839R	6	4 1/8
MA840R	7	4 1/8
MA841R	8	4 1/8



MA842R-MA846R



MA842R



MA843R



MA844R



MA845R

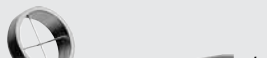

MA846R

HOFFER Optical Zone Marker

Catalog Number	Inner Diameter (mm)	Length (in.)
MA842R	4.25	4
MA843R	5	4
MA844R	5.5	4
MA845R	6	4
MA846R	8	4 1/8

EYE

MILLIMETERS

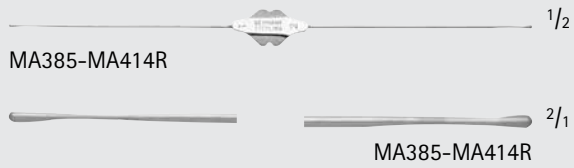

WILLIAMS Lacrimal Probe, Double Ended

Catalog Number	Tip Size (#)	Length (in.)
MA385	0000/000	5 1/8
MA410R	00/0	5 1/2
MA411R	1/2	5 1/2
MA412R	3/4	5 1/2
MA413R	5/6	5 1/2
MA414R	7/8	5 1/2

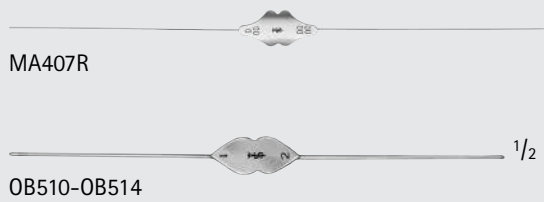

BOWMAN Lacrimal Probe, Double Ended

Catalog Number	Tip Size (#)	Tip Size (mm)	Description	Length (in.)
MA409	-	-	SET OF 6	-
MA407R	0000/000	-	-	5 5/8
OB510	00/0	0.7 / 0.8	-	5 1/8
OB511	1/2	0.9 / 1.1	-	5 1/8
OB512	3/4	1.3 / 1.4	-	5 1/8
OB513	5/6	1.5 / 1.6	-	5 1/8
OB514	7/8	1.8 / 1.9	-	5 1/8

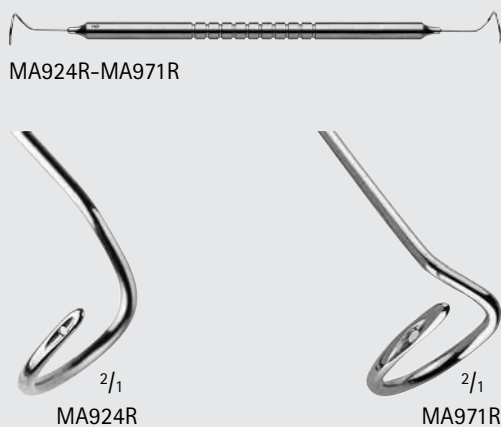

Pigtail Lacrimal Probe, Double Ended, W/ Suture Holes

Catalog Number	Tip	Diameter (mm)	Length (in.)
MA924R	BLUNT	8	5 1/8
MA971R	BLUNT	8	6 1/8



EYE

INCHES

Eye

Probes and Dilators

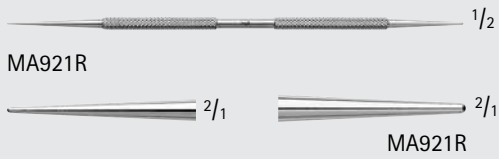

CASTROVIEJO Lacrimal Dilator, Double Ended

Catalog Number	Tip	Length (in.)
MA921R	FINE TAPPER/ MEDIUM TAPER	4 3/4

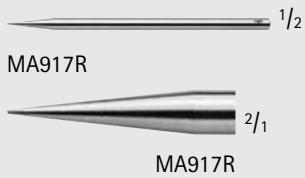

RUEDEMANN Lacrimal Dilator

Catalog Number	Tip	Length (in.)
MA917R	12 MM TAPER	2 3/4

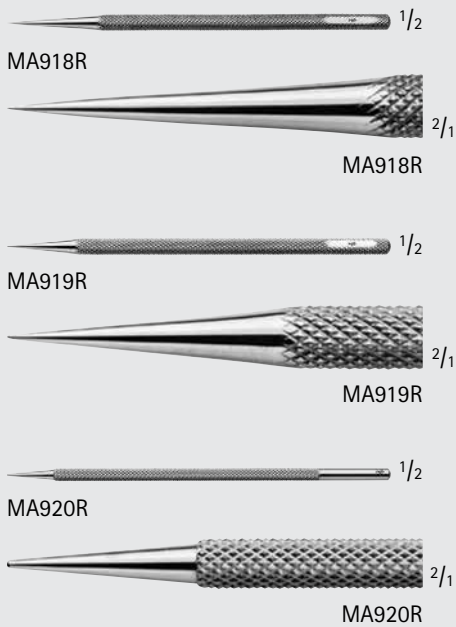

WILDER Lacrimal Dilator

Catalog Number	Tip	Tip Size (mm)	Size	Length (in.)
MA918R	LONG TAPER	23	1	4
MA919R	MEDIUM TAPER	18	2	4
MA920R	SHORT TAPER	13	3	4

EYE

MILLIMETERS

**CATALANO Lacrimal Intubation Set,
Single Use**

Catalog Number	Description
MA915R	TWO 0.7 MM PROBES ATTACHED TO 250 MM LONG SILICONE TUBING

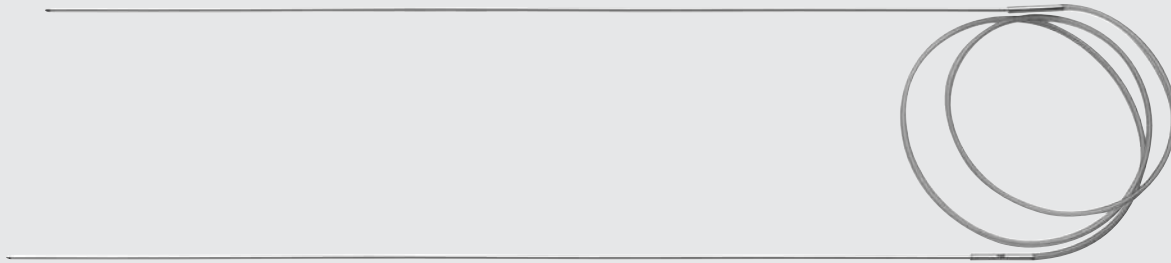

MA915R

**JACKSON Lacrimal Intubation Set,
Single Use**

Catalog Number	Description
MA916R	TWO 0.9 MM PROBES ATTACHED TO 250 MM LONG SILICONE TUBING

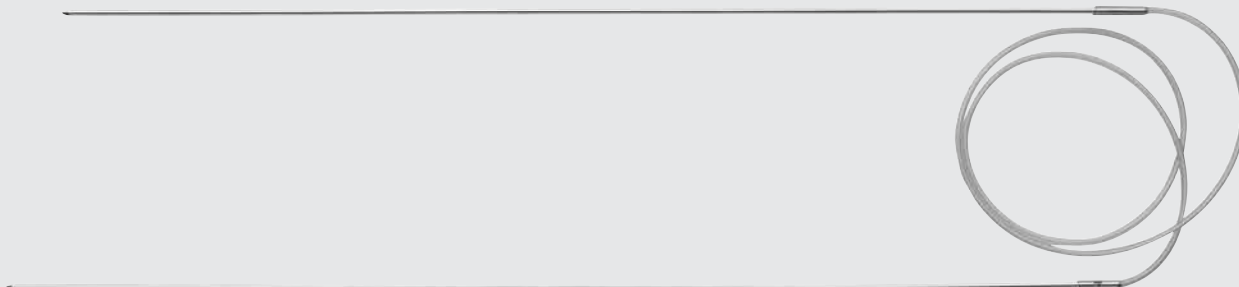

MA916R



INCHES

Eye

Lacrimal Intubation Sets



CRAWFORD Lacrimal Intubation Set, Single Use

Catalog Number	Description
MA922R	TWO OLIVE-TIPPED 0.8 MM PROBES ATTACHED TO 250 MM LONG SILICONE TUBING



MA922R

CRAWFORD Retrieving Hook

Catalog Number	Compatible w/	Length (in.)
MA923R	MA922R	5 1/8

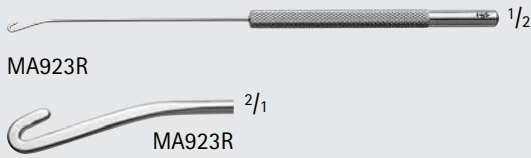

MA923R

MA923R ^{2/1}

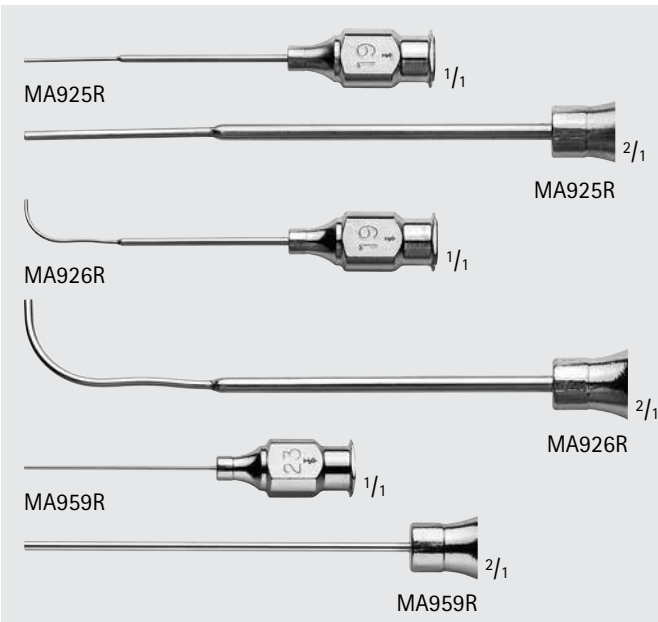

Lacrimal Cannula

Catalog Number	Tip	Tip Size (Gauge)	Shaft	Length (in.)
MA925R	REINFORCED, MALLEABLE	23	STR	1 3/8
MA926R	REINFORCED, MALLEABLE	23	CVD	1 3/8
MA959R	-	23	STR	1

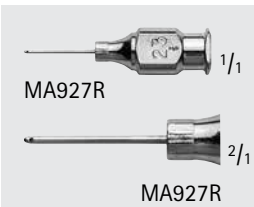

SHAHINIAN Lacrimal Cannula

Catalog Number	Tip	Tip Size (Gauge)	Shaft	Length (in.)
MA927R	0.3 MM SIDE PORT	23	STR	3/8

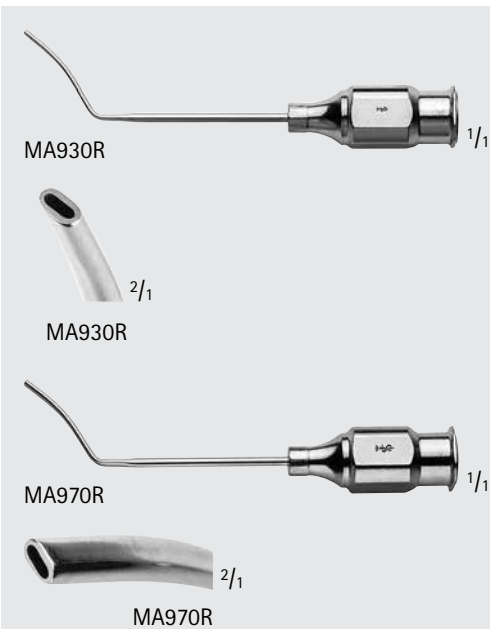

RANDOLPH Cyclodialysis Cannula

Catalog Number	Tip	Tip Size (Gauge)	Shaft	Length (in.)
MA930R	THIN	19	ANG 13 MM FROM TIP	1 3/8
MA970R	DEL	19	ANG 13 MM FROM TIP	1 1/4

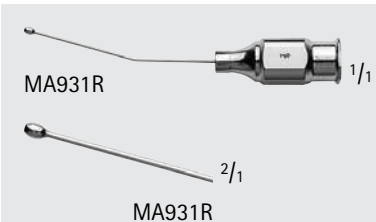

TROUTMAN Olive Tip Cannula

Catalog Number	Tip	Tip Size (Gauge)	Shaft	Length (in.)
MA931R	1	25	SLIGHT-CVD	1



INCHES

Eye Cannulas



MA932R



MA932R

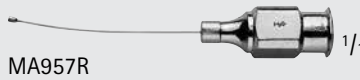

MA957R



MA957R

JENSEN Capsule Polisher, Roughened Tip, W/ Front Opening

Catalog Number	Tip	Tip Size (Gauge)	Shaft	Length (in.)
MA932R	OLIVE	25	CVD	1
MA957R	OLIVE	27	CVD	1



MA933R

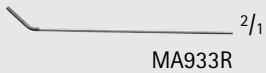

MA933R

KNOLLE Capsule Polisher, Roughened Tip

Catalog Number	Tip	Tip Size (Gauge)	Length (in.)
MA933R	2 MM ANG	30	3/4



MA934R-MA937R

BISHOP-HARMON Anterior Chamber Irrigator, 19 GA, Angled

Catalog Number	Description	Length (in.)
MA934R	COMPLETE SET	-
MA935	SILICONE BULB, 28 x 55 MM	-
MA936	PLASTIC ADAPTER, F/ USE W/ MA935	-
MA937R	CANNULA	1

MA934R Includes:

1 Cannula MA937R

1 Plastic Adaptor MA936

1 Silicone Bulb MA935



MA938R



MA938R

Hydrodissection Cannula

Catalog Number	Tip	Tip Size (Gauge)	Shaft	Length (in.)
MA938R	FLATTENED, FRONT OPENING	25	ANG	3/4

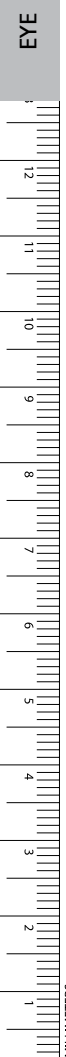



MA939R



MA939R

BRACKEN Irrigating Cannula

Catalog Number	Tip	Tip Size (Gauge)	Shaft	Length (in.)
MA939R	FLATTENED BEVELED, FRONT OPENING	19	CVD	1 1/4



MA940R

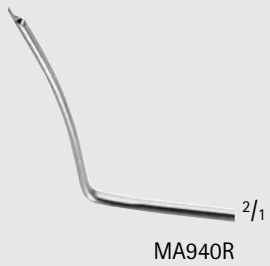

MA940R

SLADE LASIK Cannula

Catalog Number	Tip	Tip Size (Gauge)	Shaft	Length (in.)
MA940R	FLATTENED SPATULA, FRONT OPENING	26	ANG	1/2

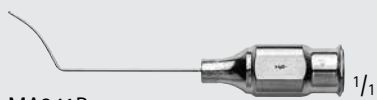

MA941R

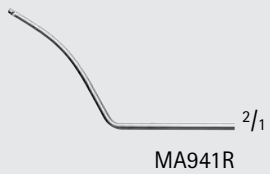

MA941R

BURATTO Cannula

Catalog Number	Tip	Tip Size (Gauge)	Shaft	Length (in.)
MA941R	FLATTENED, 1 FRONT AND 2 SIDE PORTS	25	ANG	1



Eye Cannulas

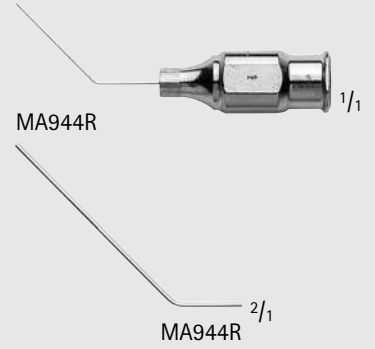
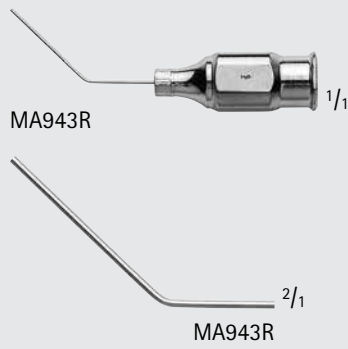
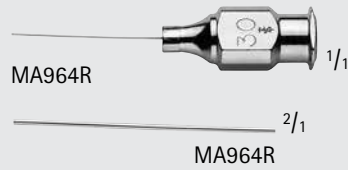
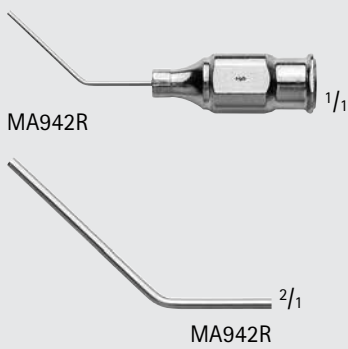
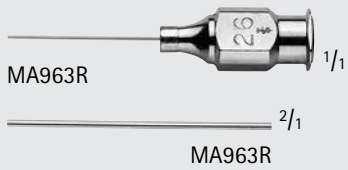
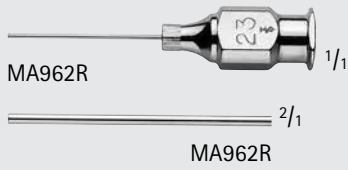

MCINTYRE Anterior Chamber Cannula

Catalog Number	Tip	Tip Size (Gauge)	Shaft	Length (in.)
MA962R	BLUNT	23	STR	3/4
MA963R	BLUNT	26	STR	3/4
MA964R	BLUNT	30	STR	3/4
MA942R	BLUNT	23	ANG 12 MM FROM TIP	3/4
MA943R	BLUNT	26	ANG 12 MM FROM TIP	3/4
MA944R	BLUNT	30	ANG 12 MM FROM TIP	3/4

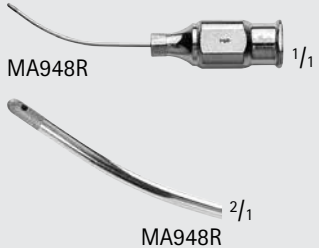
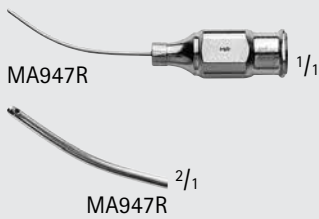
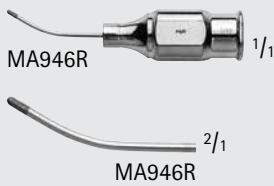
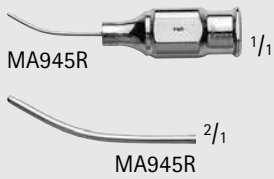

SIMCOE Cortex Extractor, Side Port

Catalog Number	Tip	Tip Size (Gauge)	Shaft	Length (in.)
MA945R	SMOOTH, 0.3 MM	23	CVD	1/2
MA946R	ROUGHENED, 0.3 MM	23	CVD	1/2
MA947R	SMOOTH, 0.3 MM	23	CVD	3/4
MA948R	ROUGHENED, 0.3 MM	23	CVD	3/4



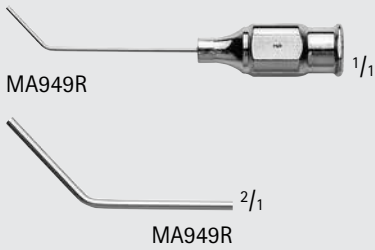

MORRISON Aspirating Cannula, Front Opening

Catalog Number	Tip	Tip Size (Gauge)	Shaft	Length (in.)
MA949R	SMOOTH, BLUNT	23	ANG 7 MM FROM TIP	1

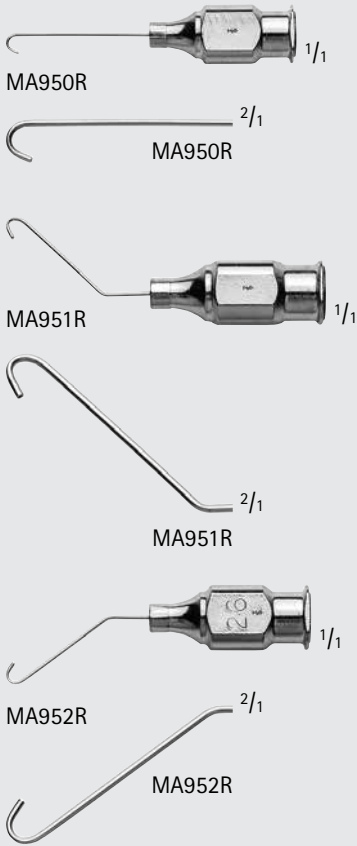

MCINTYRE-BINKHORST Cannula, Front Opening, Hook Shape

Catalog Number	Tip	Tip Size (Gauge)	Shaft	Length (in.)
MA950R	SMOOTH, BLUNT	26	STR	3/4
MA951R	SMOOTH, BLUNT	26	RIGHT ANG	3/4
MA952R	SMOOTH, BLUNT	26	LEFT ANG	3/4

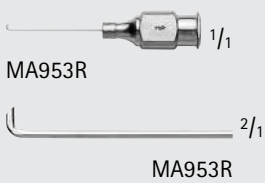

CHANG Nucleus Hydrodissector Cannula

Catalog Number	Tip	Tip Size (Gauge)	Shaft	Length (in.)
MA953R	FLAT, BEVELED OPENING	27	RIGHT ANG	1/2

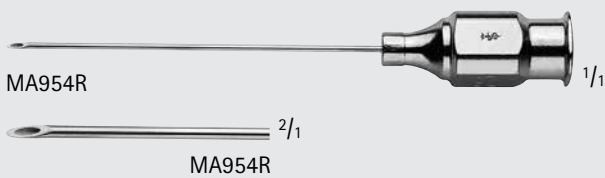

ATKINSON Retrobulbar Needle

Catalog Number	Tip Size (Gauge)	Shaft	Length (in.)
MA954R	23	STR	1 3/8



EYE

INCHES

Eye Cannulas

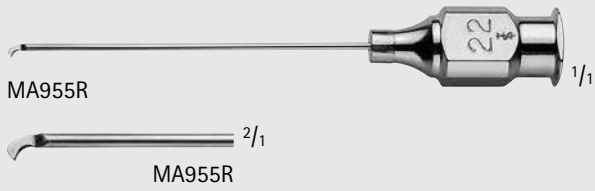

KELMAN Cystotome

Catalog Number	Tip Size (Gauge)	Shaft	Length (in.)
MA955R	22	STR	1 1/4

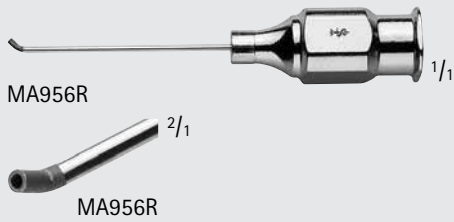

KRATZ Capsule Scrubber

Catalog Number	Tip	Tip Size (Gauge)	Shaft	Length (in.)
MA956R	ROUGHENED	23	ANG	3/4

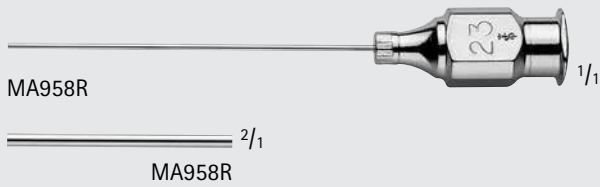

Backflush Infusion Cannula

Catalog Number	Tip Size (Gauge)	Shaft	Length (in.)
MA958R	23	STR	1 3/8

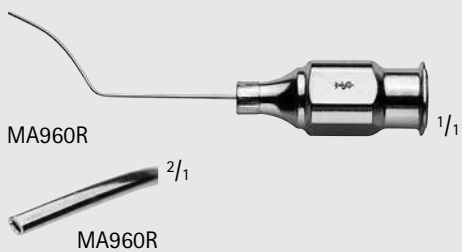

NICHAMIN Hydrodissection Cannula

Catalog Number	Tip Size (Gauge)	Shaft	Length (in.)
MA960R	25	ANG	1

EYE

MILLIMETERS



MA640R

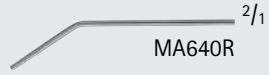

MA640R



MA641R

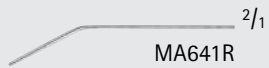

MA641R

Air Injection Cannula

Catalog Number	Tip Size (mm)	Tip Size (Gauge)	Shaft	Length (in.)
MA640R	5	27	ANG	3/4
MA641R	5	30	ANG	3/4



MA968R

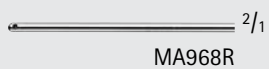

MA968R

WEST Lacrimal Cannula, Side Port

Catalog Number	Tip Size (mm)	Tip Size (Gauge)	Shaft	Length (in.)
MA968R	0.3	23	STR	1 1/4

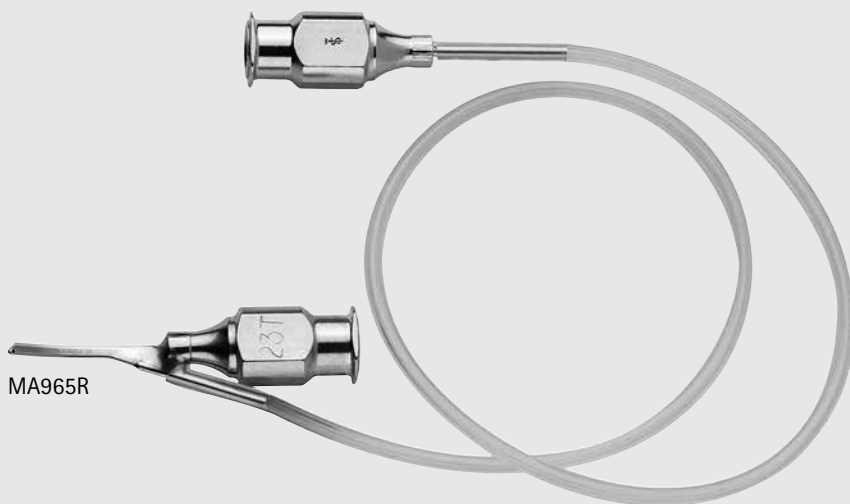

MA965R

SIMCOE Irrigating Aspirating Unit

Catalog Number	Tip Size (Gauge)	Description
MA965R	23	ASPIRATION THROUGH 0.3 MM TOP PORT, IRRIGATION THROUGH FRONT PORT, USES 225 MM TUBING



Eye

Miscellaneous



MA002R



MA001R

BRAUNSTEIN Fixed Caliper, Double Ended

Catalog Number	Tip Size (mm)	Length (in.)
MA002R	3.0 / 3.5	2 3/4
MA001R	3.5 / 4.0	2 3/4



MB791R



OB793R

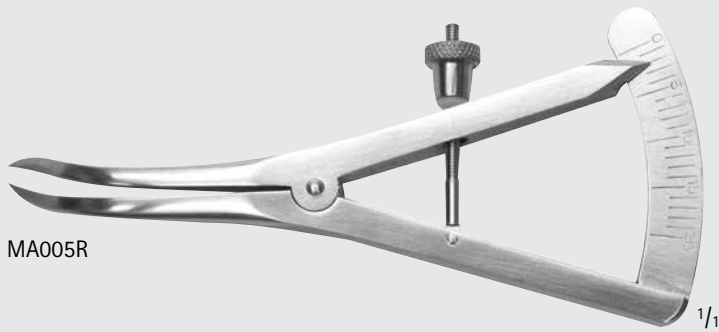

MA005R

CASTROVIEJO Eye Caliper

Catalog Number	Tip	Description	Length (in.)
MB791R	STR	0 - 15 MM RANGE	3 1/8
OB793R	STR	0 - 40 MM RANGE	6 3/4
MA005R	CVD	0 - 20 MM RANGE	3 3/8



MA888R



MA888R

AKAHOSHI Combo Prechopper, Cross-Action

Catalog Number	Jaw	Jaw Length (mm)	Length (in.)
MA888R	STR	4.5	4 1/4

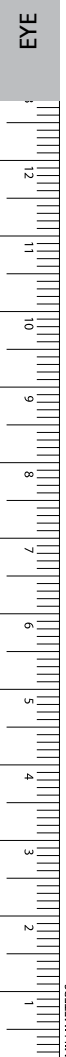

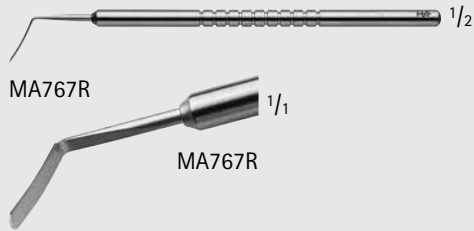

Corneal Dissector Knife

Catalog Number	Blade	Shaft	Length (in.)
MA767R	CVD	ANG	4 1/2

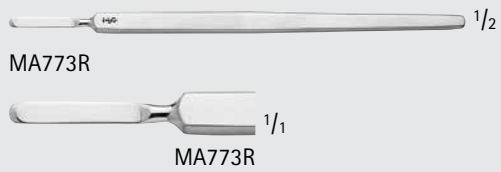

TOOKE Corneal Knife

Catalog Number	Blade	Blade Size (mm)	Length (in.)
MA773R	STR	3 x 18	4 3/4

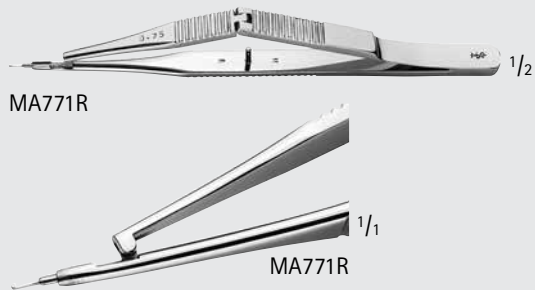

KELLY-DESCEMET'S Membrane Punch

Catalog Number	Diameter (mm)	Length (in.)
MA771R	1	5 1/8

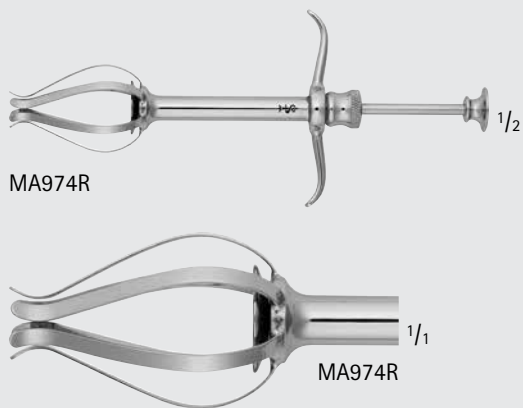

CARTER Sphere Introducer

Catalog Number	Length (in.)
MA974R	5

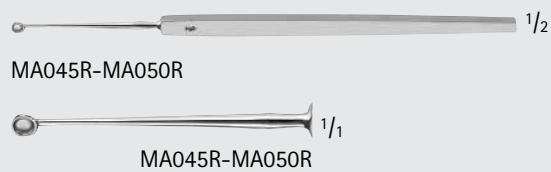

MEYERHOEFFER Chalazion Curette

Catalog Number	Tip Size (#)	Cup (mm)	Length (in.)
MA045R	0	1.5	5
MA046R	1	1.7	5
MA047R	2	2	5
MA049R	3	2.5	5
MA050R	4	3.5	5



EYE

INCHES

Eye

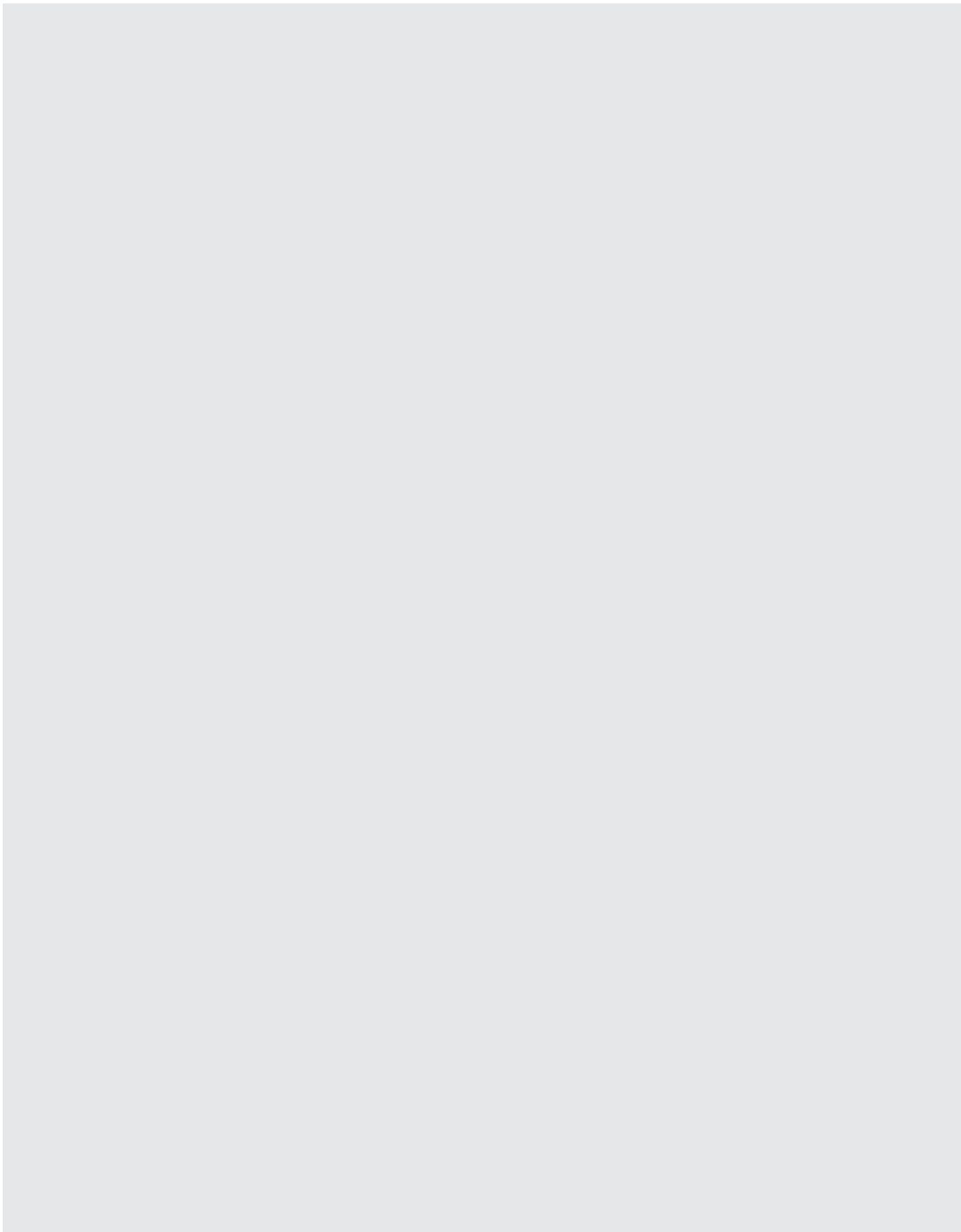



Orthopedics/Spine

Scissors	880 - 885
Plaster/Nail/Wire Instruments	886 - 898
Meniscus Instruments	899
Forceps	900 - 916
Retractors	917 - 956
Rasps	957 - 959
Elevators and Bone Levers	960 - 973
Chisels/Gouges/Osteotomes	974 - 987
Mallets/Impactors/Bone Tamps	988 - 994
Drills/Burr/Reamers	995 - 996
Reamers and Trephines	997
Curettes	998 - 1013
Microdiscectomy Instruments	1014 - 1018
Dissectors and Probes	1019
Rongeurs	1020 - 1049
Kerrison Bone Punches	1050 - 1057
KAIRison Pneumatic Bone Punch	1058 - 1059
Bone Cutters	1060 - 1063
Rulers, Calipers and Gauges	1064 - 1065

Orthopedics/Spine

Scissors



BC881R-BC989R

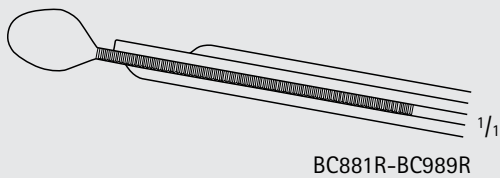

BC881R-BC989R

Universal Bandage Scissors

Catalog Number	Handle Color	Length (in.)
BC881R	BLACK	7
BC980R	RED	7
BC981R	BLUE	7
BC983R	YELLOW	7
BC985R	ORANGE	7
BC987R	PINK	7
BC988R	LIGHT GREEN	7
BC989R	VIOLET	7



BC885R-BC979R

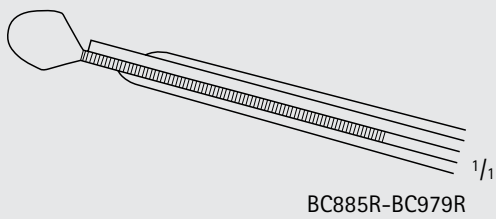

BC885R-BC979R

LISTER Universal Bandage Scissors

Catalog Number	Handle Color	Length (in.)
BC885R	BLACK	5 3/4
BC970R	RED	5 3/4
BC971R	BLUE	5 3/4
BC973R	YELLOW	5 3/4
BC975R	ORANGE	5 3/4
BC977R	PINK	5 3/4
BC978R	LIGHT GREEN	5 3/4
BC979R	VIOLET	5 3/4





BC876R, MB146R

1/2

LISTER Bandage Scissors, Serrated

Catalog Number	Length (in.)
MB146R	3 1/2
BC876R	6 1/4

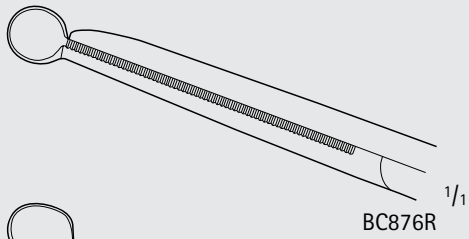

BC876R

1/1

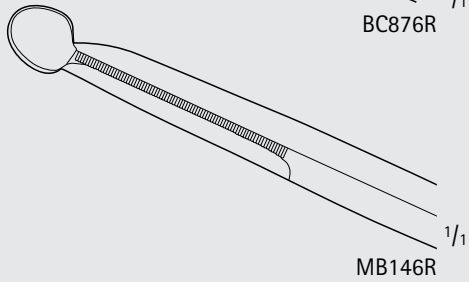

MB146R

1/1



Orthopedics/Spine

Scissors



BC848R-BC863R

1/2

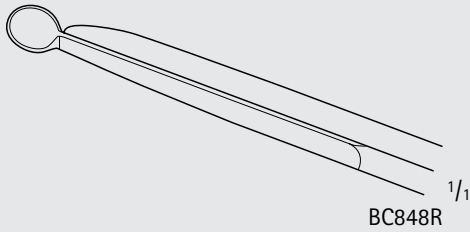

BC848R

1/1

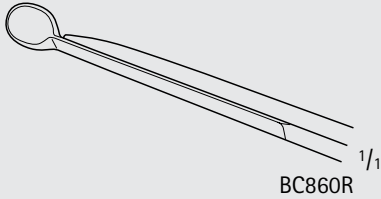

BC860R

1/1

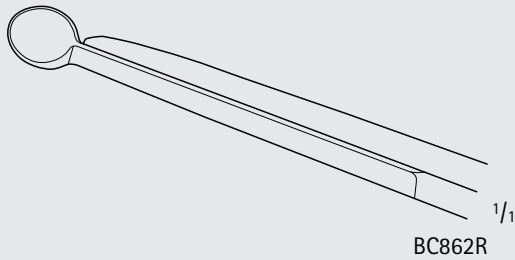

BC862R

1/1

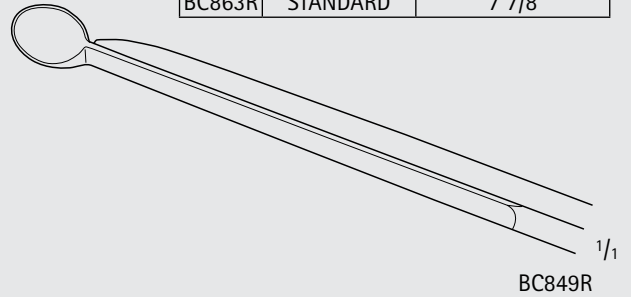

BC849R

1/1

LISTER Bandage Scissors

Catalog Number	Blade	Length (in.)
BC848R	LONG	6 1/8
BC849R	LONG	7
BC860R	STANDARD	4 1/2
BC861R	STANDARD	5 1/2
BC862R	STANDARD	7
BC863R	STANDARD	7 7/8

LISTER Bandage Scissors W/ One Large Ring

Catalog Number	Length (in.)
MB223	8



MB223

1/2



MB223

1/1

Plaster and Bandage Scissors

Catalog Number	Length (in.)
LX558R	9 1/4

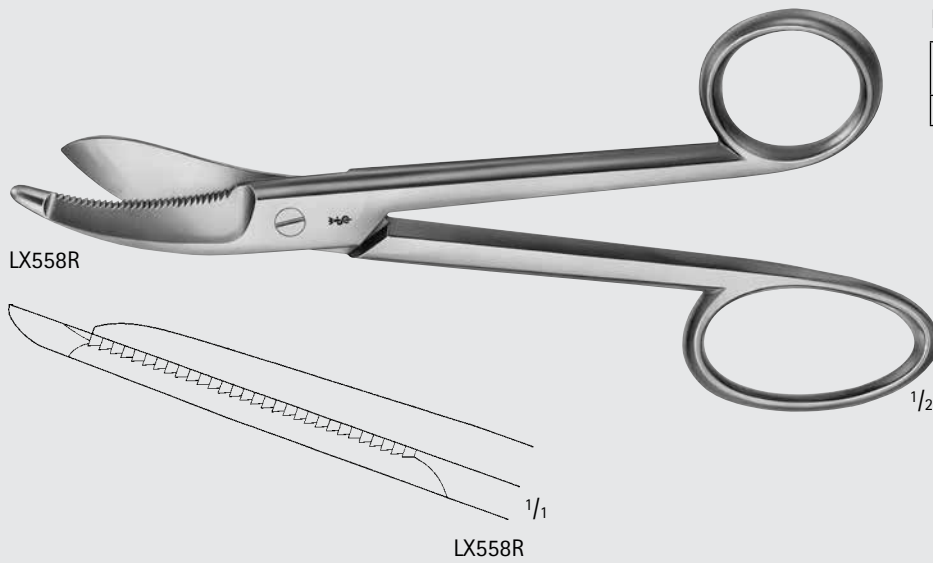

Plaster Scissors

Catalog Number	Length (in.)
LX548R	6 1/4



BRUNS Plaster Scissors

Catalog Number	Length (in.)
LX556R	9 1/4

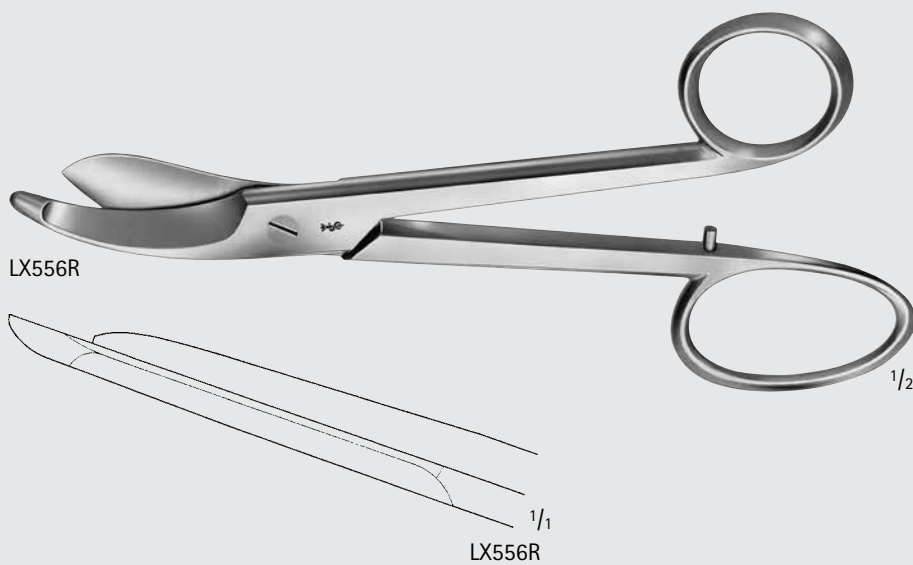

Orthopedics/Spine

Scissors

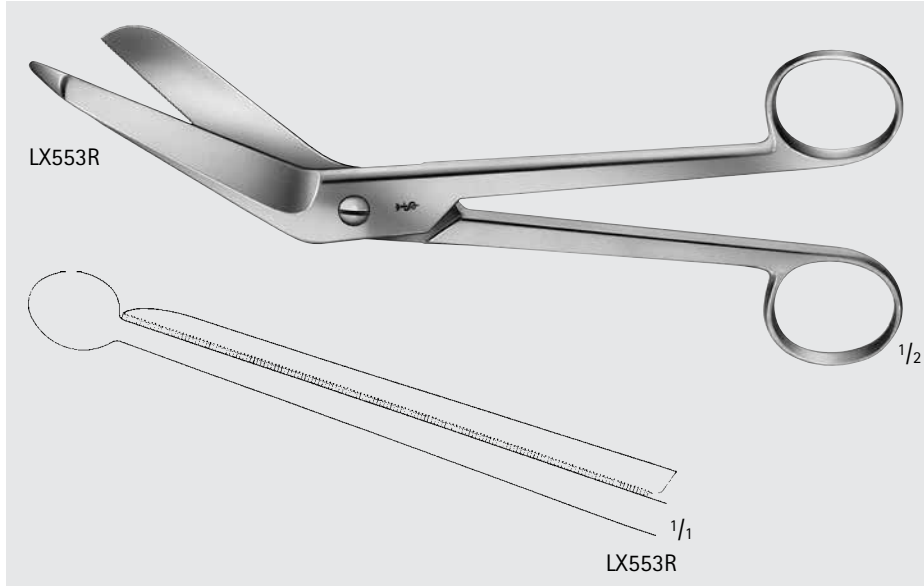

BERGMANN Plaster Scissors

Catalog Number	Length (in.)
LX553R	9

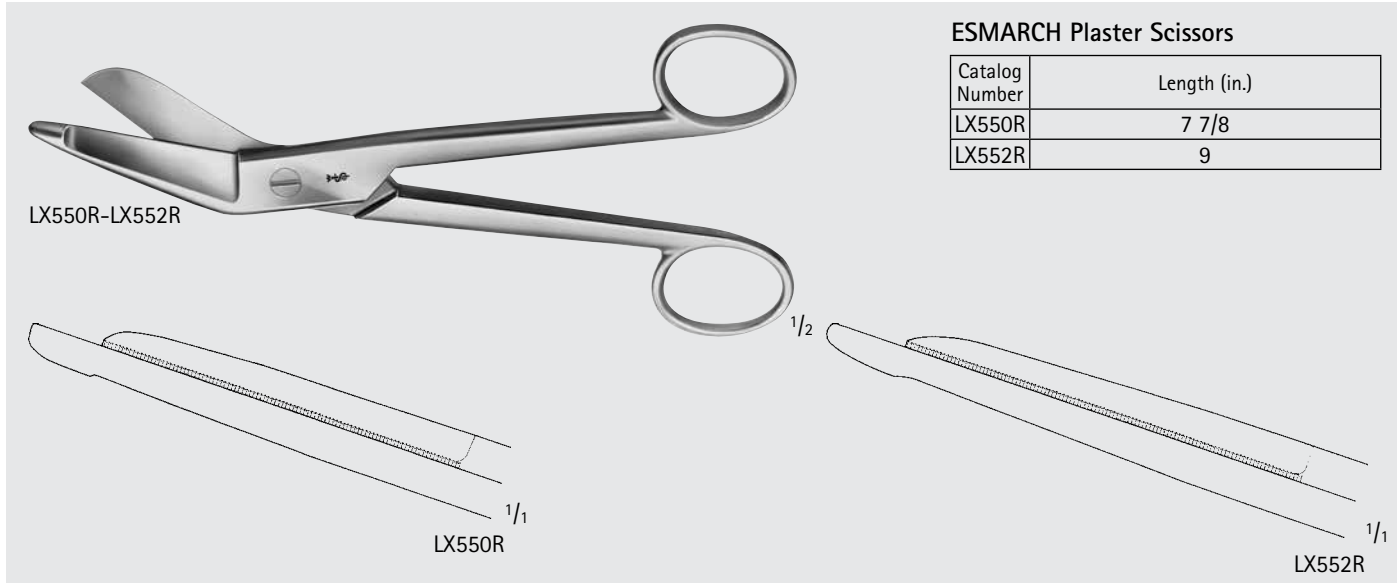

ESMARCH Plaster Scissors

Catalog Number	Length (in.)
LX550R	7 7/8
LX552R	9

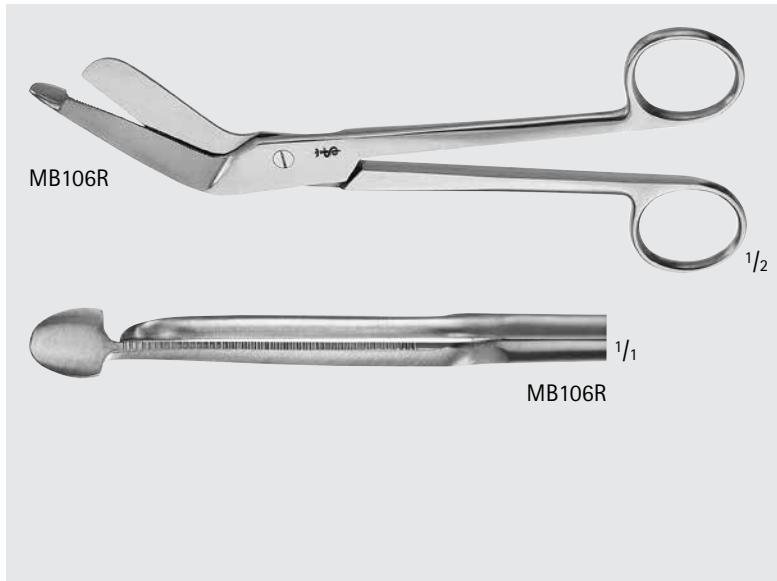

HERCULES Plaster Shears

Catalog Number	Length (in.)
MB106R	7 1/2

Plaster Scissors

Catalog Number	Length (in.)
BC888R	8

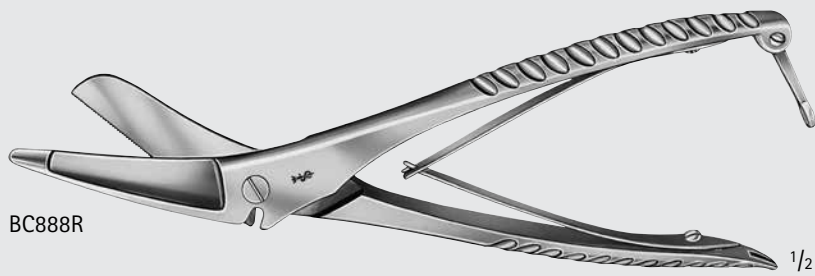

BC888R

1/2

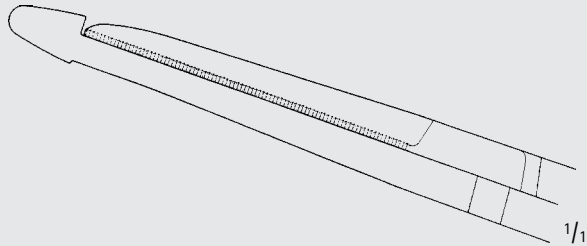

1/1

BC888R

SEUTIN Plaster and Bandage Scissors

Catalog Number	Length (in.)
LX565R	9



LX565R

1/2

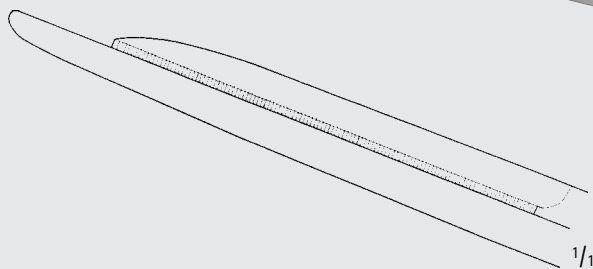

1/1

LX565R

RESANO Cartilage Scissors

Catalog Number	Tip	Blade	Length (in.)
BC595R	B/B	ANG	9 3/4

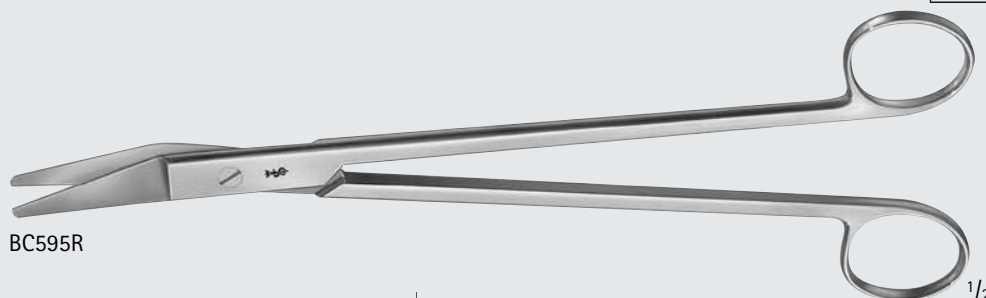

BC595R

1/2

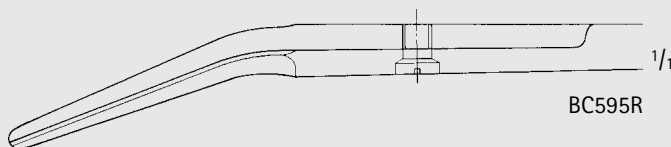

1/1

BC595R



Orthopedics/Spine

Plaster and Nail Instruments



LX600R

1/3

HENNIG Plaster Spreader

Catalog Number	Length (in.)
LX600R	10 5/8



LX605R

1/3

Plaster Spreader

Catalog Number	Length (in.)
LX605R	9



LX618R-LX624R

1/2

WOLFF Plaster Breaker

Catalog Number	Length (in.)
LX618R	7
LX624R	9 1/2



HF213R

1/2



HF213R

1/1

Nail Cutter

Catalog Number	Length (in.)
HF213R	5 1/4





BC521R

SYSTRUNK Nail Splitting Scissors

Catalog Number	Tip	Blade	Length (in.)
BC521R	S/S	STR	5 1/8

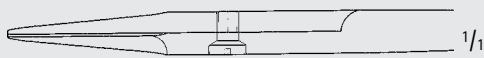

BC521R



HF021R

Nail Scissors

Catalog Number	Tip	Blade	Length (in.)
HF021R	S/S	CVD	4 1/4

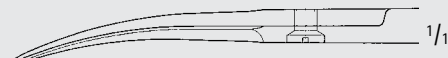

HF021R



MB370R

Needle Nose Pliers/Wire Cutters

Catalog Number	Length (in.)
MB370R	7 1/4

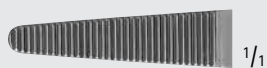

MB370R



Orthopedics/Spine

Wire Instruments

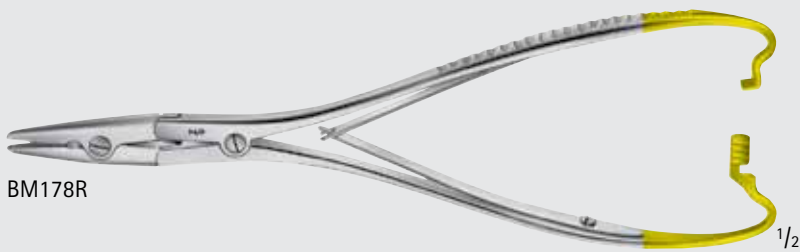

BM178R

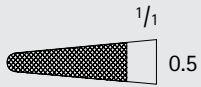

BM178R

DUROGRIP™ TC AESCULAP Needle Holder, Double Action

Catalog Number	Handle	Jaw	Length (in.)
BM178R	RATCHET	SERR	7 7/8



LX150R



LX150R



LX152R



LX152R

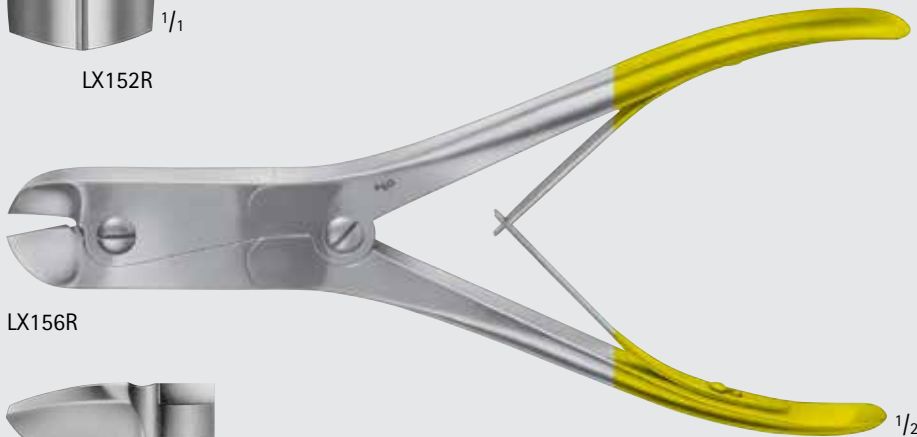

LX156R



LX156R

Wire Cutter, W/ Specially Hardened Cutting Edges

Catalog Number	For Wire Size	Length (in.)
LX150R	SOFT, UP TO 2MM AND HARD, UP TO 1.5MM	5 3/4
LX152R	SOFT, UP TO 3.5MM AND HARD, UP TO 2.0MM	8 3/4
LX156R	SOFT, UP TO 3MM AND HARD, UP TO 2.2MM	9 1/4



HARVEY Wire Cutter, W/ Specially Hardened Cutting Edges

Catalog Number	For Wire Size	Tip	Length (in.)
LX157R	SOFT, UP TO 3MM AND HARD, UP TO 2.2MM	ANG	9 1/4



LX157R

1/2

Wire Cutter, Front and Lateral, W/ Specially Hardened Cutting Edges

Catalog Number	Wire Size	Length (in.)
LX158R	SOFT, UP TO 2MM AND HARD, UP TO 1.5MM	7



LX158R

1/2



1/1

LX158R



ORTHO
SPINE

Orthopedics/Spine

Wire Instruments



LX159R



LX159R

REILL Cutter, F/ Wire Close To Bone, W/ Specially Hardened Cutting Edges

Catalog Number	For Wire Size	Length (in.)
LX159R	SOFT, UP TO 2MM AND HARD, UP TO 1.5MM	6 7/8

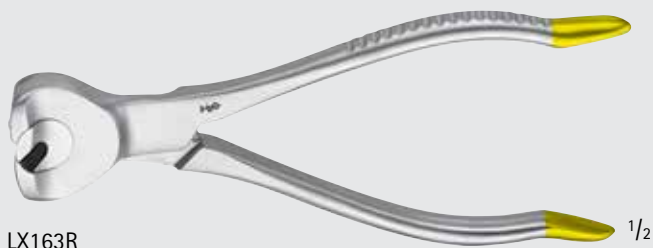

LX163R



LX163R

Front Cutter, W/ Specially Hardened Cutting Edges

Catalog Number	For Wire Size	Length (in.)
LX163R	SOFT, UP TO 3.5MM AND HARD, UP TO 2.5MM	6 1/2



LX162R

TC Wire Cutter W/ Carbide Cutting Edges

Catalog Number	Length (in.)
LX162R	9 1/2



TC Wire Cutter Double Action

Catalog Number	Packaging	Tip	Length (in.)
MG025R	2.5	ANG	8 3/4

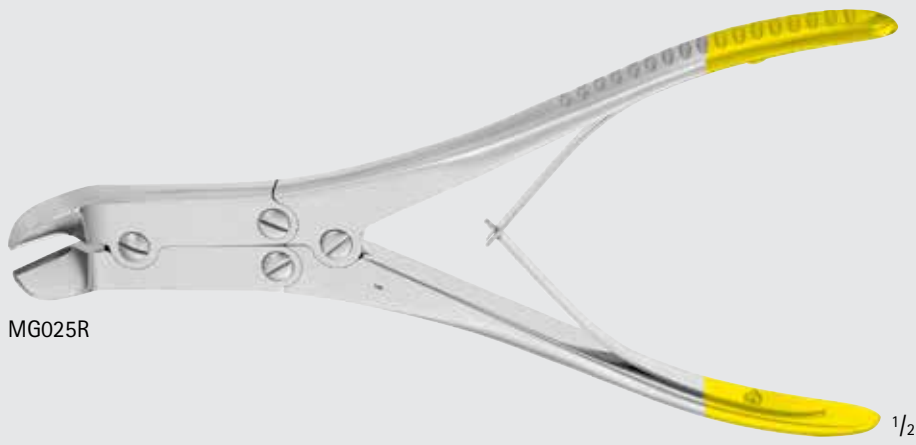

MG025R

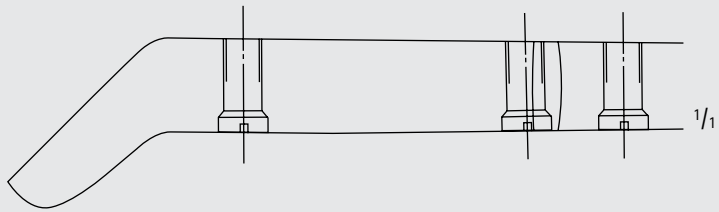

TC Flush Wire Cutter

Catalog Number	Packaging	Tip	Length (in.)
MG029R	1.6	FRONT AND LATERAL	6 3/4



Orthopedics/Spine

Wire Instruments

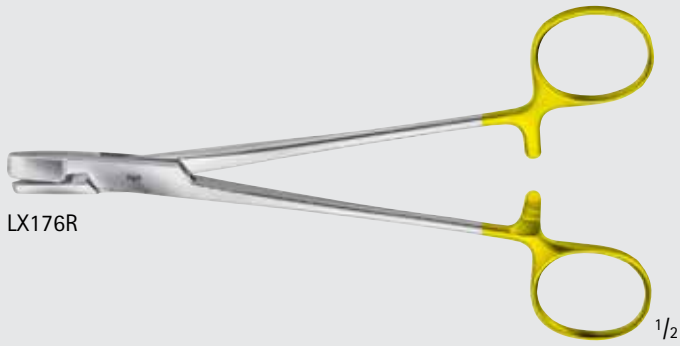

LX176R

1/2



LX176R

1/1

Wire Holding Forceps W/Hard Metal Inserts

Catalog Number	Length (in.)
LX176R	6 3/4



LX179R

1/2

Wire Grasping Forceps W/Hard Metal Inserts

Catalog Number	Tip	Length (in.)
LX179R	FLAT	7 1/2



HERCULES Pin Cutter

Catalog Number	Packaging	Description	Length (in.)
MG088R	3	TUNGSTEN CARBIDE	8 3/4

MG088R



Pin Cutter, End-Cutting

Catalog Number	Packaging	Length (in.)
MG089R	4.7	14 3/4
MG090R	6.3	22 1/2

MG089R

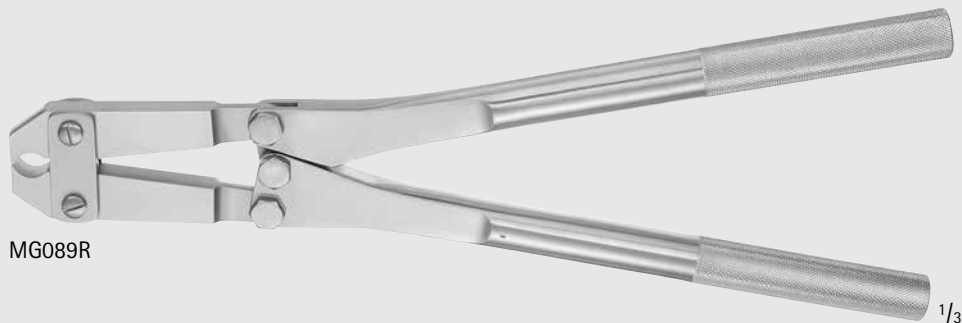

MG090R

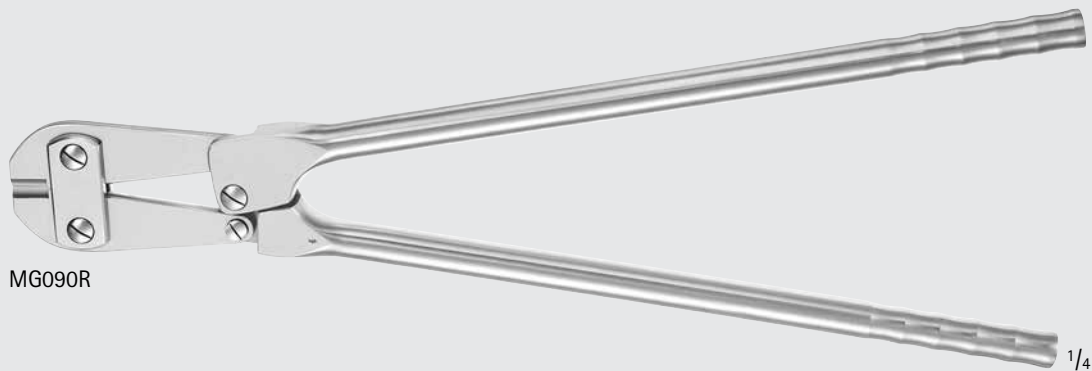

Orthopedics/Spine

Wire Instruments



Bolt Cutter

Catalog Number	Item	Length (in.)
LX164R	F/KIRSCHNER WIRES, TIBIA HEAD SCREWS, BOLTS, PINS, UP TO 6MM	18 1/2

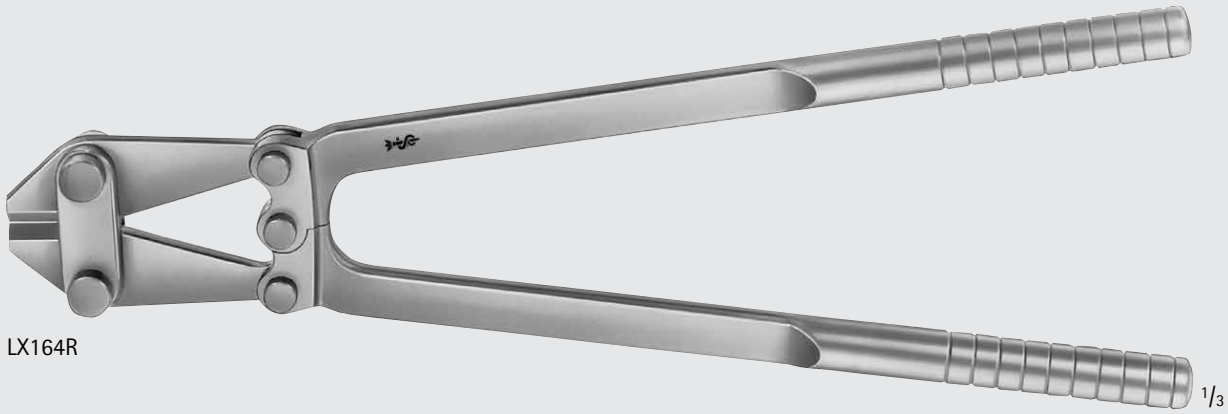

LX164R

Bolt Cutter

Catalog Number	Item	Length (in.)
LX165R	F/KIRSCHNER WIRES, TIBIA HEAD SCREWS, BOLTS, PINS, UP TO 6MM	12 1/2



LX165R



LX165R



LX170R-LX171R

1/2

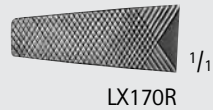

LX170R

1/1



LX171R

1/1

Wire Holding Pliers

Catalog Number	Tip	Length (in.)
LX170R	SERR	6 3/4
LX171R	CROSS-GROOVES	6 3/4

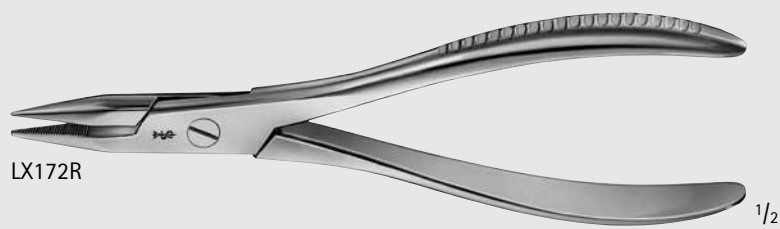

LX172R

1/2



LX172R

1/1

Wire Holding Forceps

Catalog Number	Tip	Length (in.)
LX172R	SERR	7 1/2



MG026R

1/2

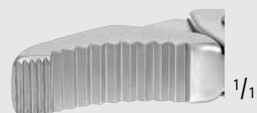

1/1



MG026R

1/1

Wire Holding Pliers

Catalog Number	Tip	Tip Size (mm)	Length (in.)
MG026R	LOCKING	7	7



ORTHO
SPINE

INCHES

Orthopedics/Spine

Wire Instruments



MG028R

Wire Holding Needle-Nose Pliers

Catalog Number	Tip	Tip Size (mm)	Length (in.)
MG028R	LOCKING, NEEDLE-NOSE	5	9 1/2



1/1

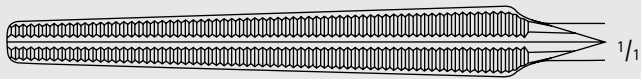

1/1

MG028R

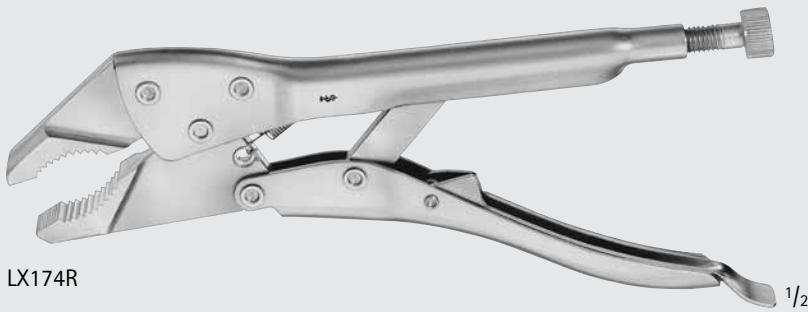

LX174R

Vise Grip Pliers

Catalog Number	Tip	Length (in.)
LX174R	FLAT NOSE	7 7/8



1/1

LX174R





LX175S

Bending Iron

Catalog Number	FOR BORING WIRE SIZE	Length (in.)
LX175S	UP TO 2.7MM	4 3/4



LX177R-LX178R

Wire Extraction Pliers

Catalog Number	Length (in.)
LX177R	5 1/8
LX178R	7



1/1



1/1



1/1



1/1

LX177R

LX178R

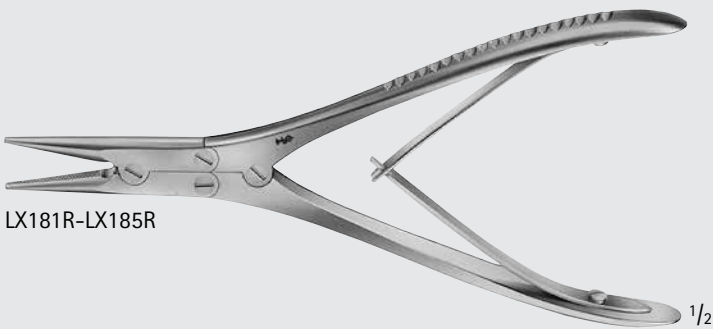

LX181R-LX185R

Wire Extraction Pliers

Catalog Number	Tip	Length (in.)
LX181R	RND	7
LX182R	RND, SHORT JAW	7
LX183R	FLAT	7
LX185R	PARALLEL	5 3/4

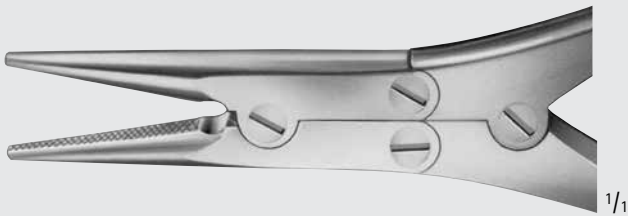

1/1

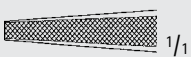

1/1

LX181R



1/1

LX182R



1/1

LX183R



1/1

LX185R



INCHES

Orthopedics/Spine

Wire Instruments

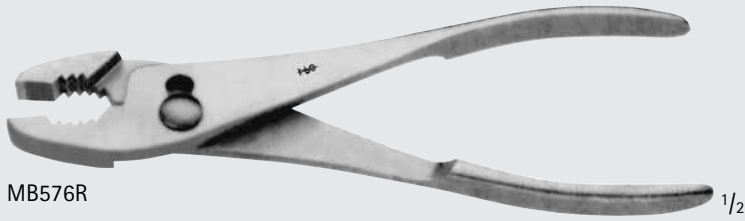

MB576R

1/2

Utility Pliers

Catalog Number	Length (in.)
MB576R	7 3/4



LX189R

1/2

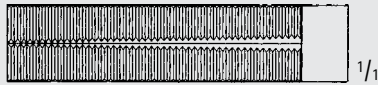

1/1

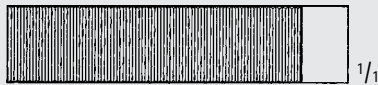

1/1

LX189R

Flat Nosed Pliers

Catalog Number	Tip	Length (in.)
LX189R	PARALLEL	7 1/4

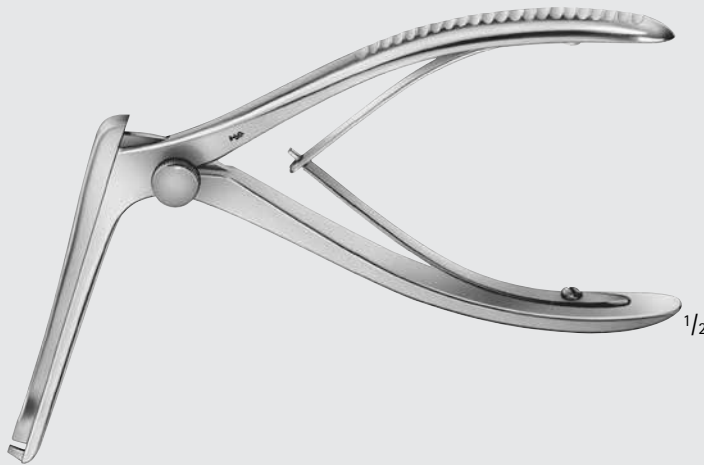

LX190R

1/2

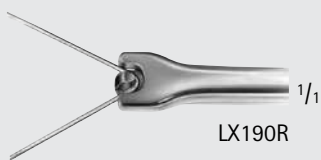

LX190R

1/1

Wire Bending Pliers

Catalog Number	For Wire Size
LX190R	UP TO 1.8MM



SMILLIE Meniscotome

Catalog Number	Jaw	Length (in.)
F0857R	STRAIGHT	6 3/4
F0855R	LEFT	6 3/4
F0856R	RIGHT	6 3/4



F0857R



1/16

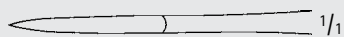

1/16

F0857R



F0855R



1/16

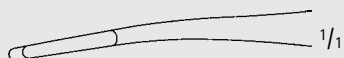

1/16

F0855R



F0856R



1/16

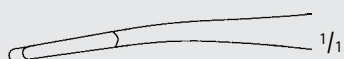

1/16

F0856R



Orthopedics/Spine

Forceps

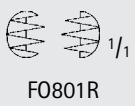
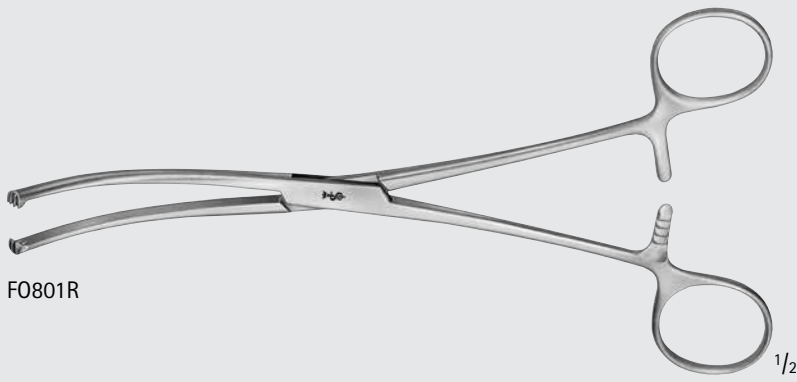
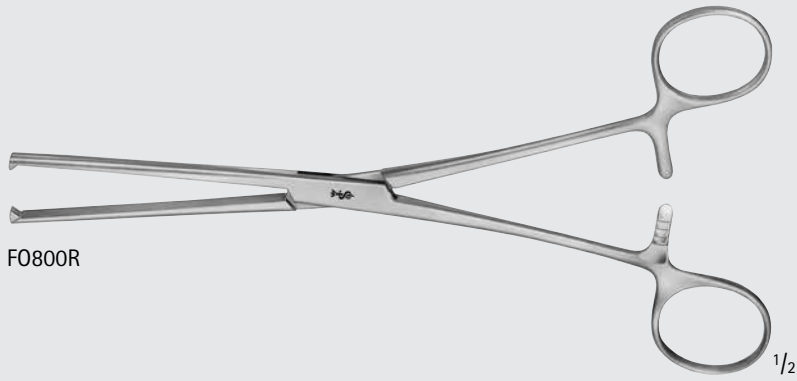

BIRCHER Cartilage Forceps

Catalog Number	Jaw	Length (in.)
FO800R	STR	7 7/8
FO801R	CVD	7 7/8



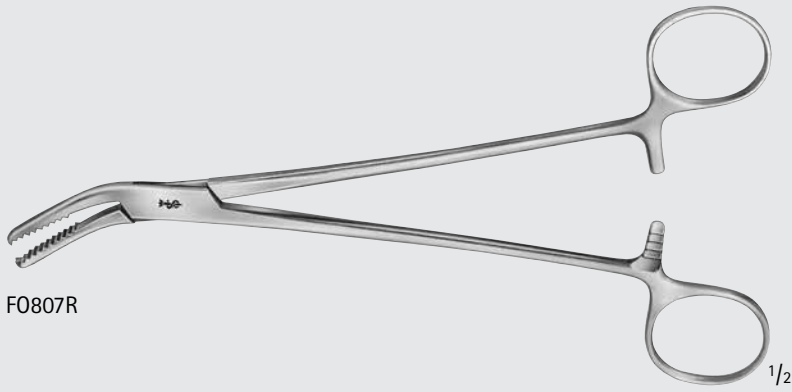

FO807R

1/2



1/1

FO807R

WELLER Cartilage Forceps

Catalog Number	Jaw	Length (in.)
FO807R	CVD	7 7/8

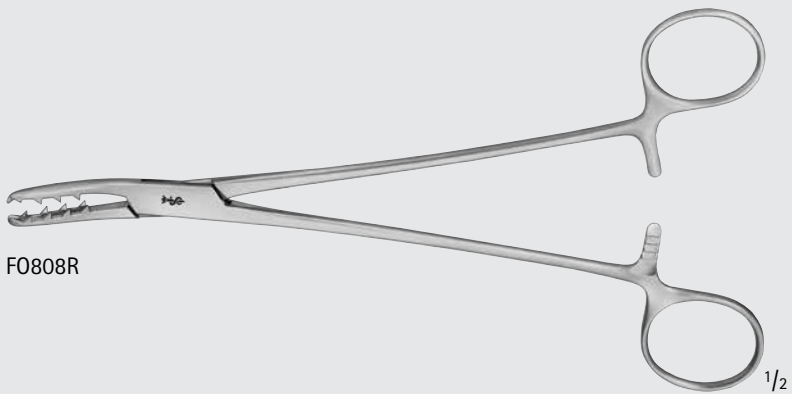

FO808R

1/2



1/1

FO808R

BIRCHER-GANSKE Cartilage Forceps

Catalog Number	Jaw	Length (in.)
FO808R	SLIGHT CVD	7 7/8



Orthopedics/Spine

Forceps

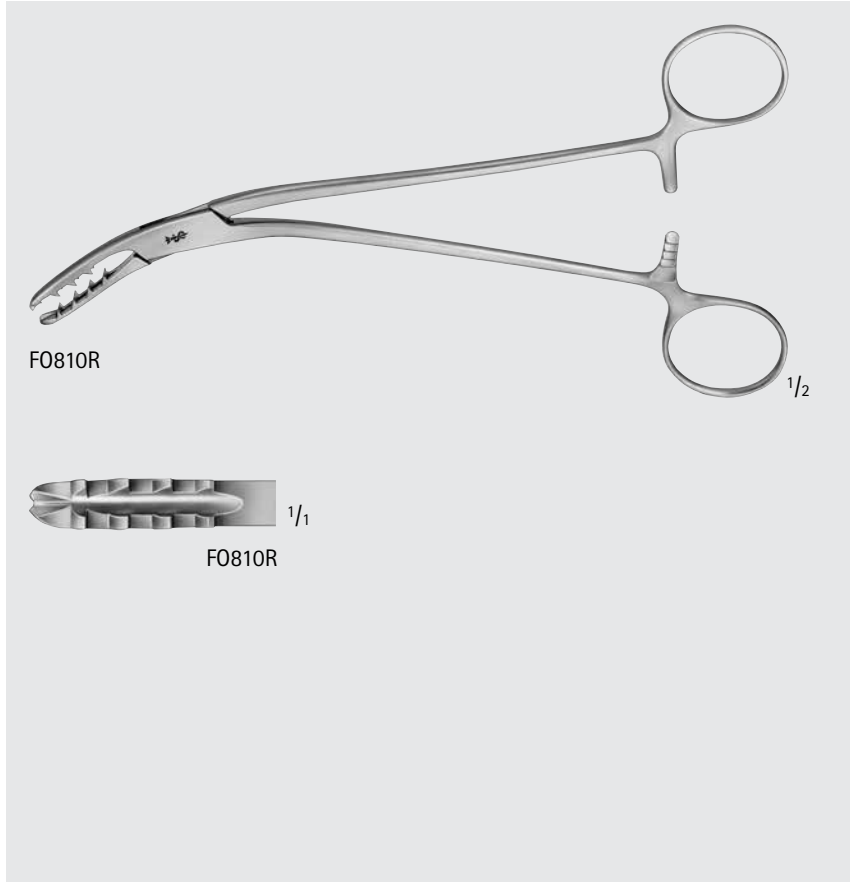

BIRCHER-GANSKE Cartilage Forceps (continued)

Catalog Number	Jaw	Length (in.)
F0810R	CVD	7 7/8

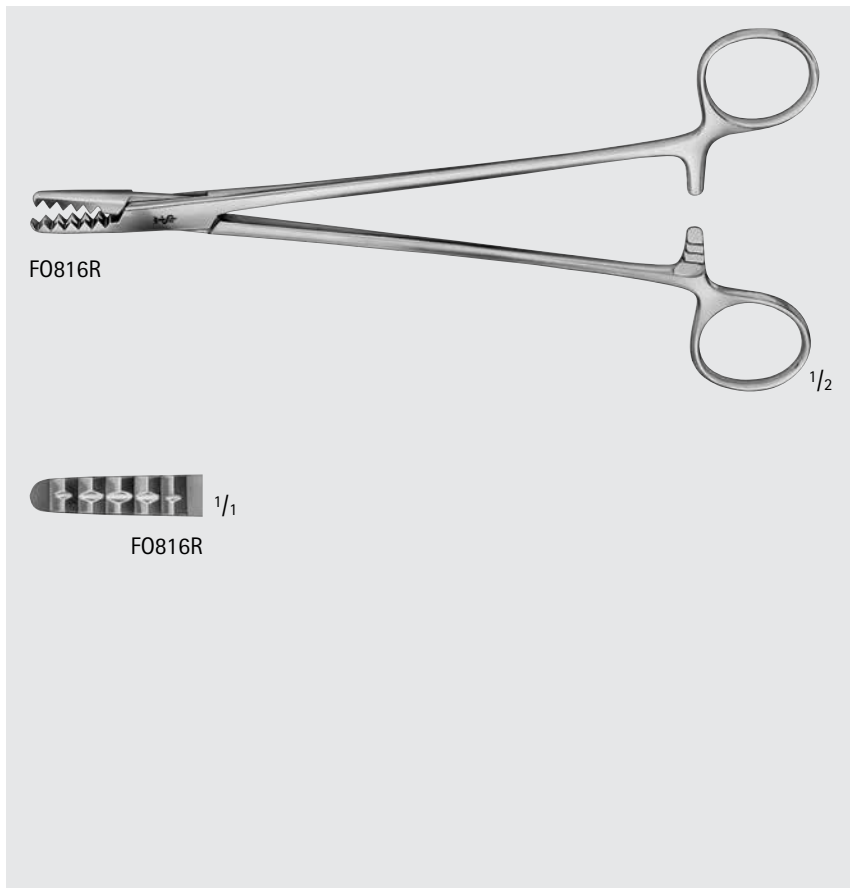

MARTIN Cartilage Forceps

Catalog Number	Jaw	Length (in.)
F0816R	STR	8

MEYER Reposition Forceps, F/ Wires

Catalog Number	For Wire Size	Length (in.)
FO106R	UP TO 1MM	6 3/4
FO108R	UP TO 2MM	8

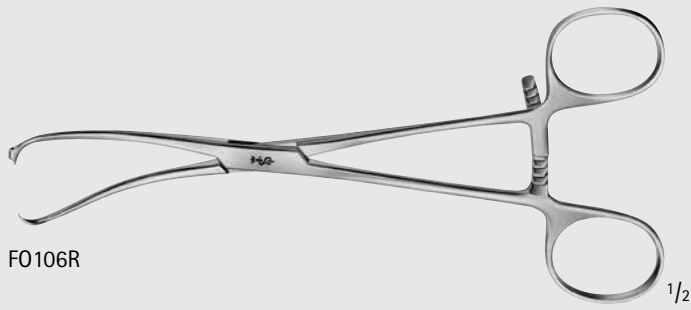

FO106R



1/1



FO106R

1/1

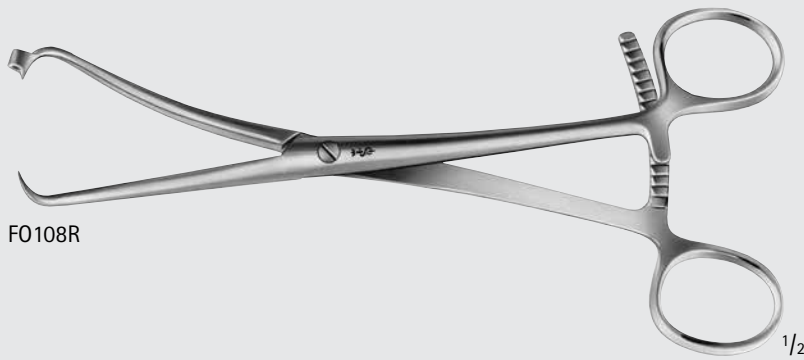

FO108R

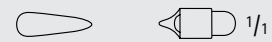

1/1

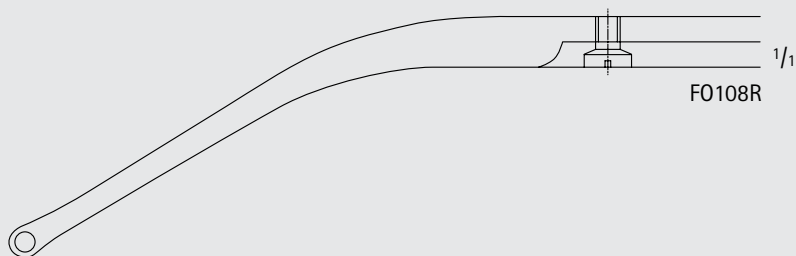

FO108R

1/1



Orthopedics/Spine

Bone Holding Forceps



DINGMANN Bone Holding Forceps

Catalog Number	Teeth	Length (in.)
FO110R	2 x 2	7 1/4

DINGMANN Bone Holding Forceps

Catalog Number	Teeth	Shaft	Length (in.)
FO111R	2 x 2	CVD	7 1/4

Bone Holding Forceps

Catalog Number	Length (in.)
FO112R	8 1/4

Finger Reposition Forceps, Stepped Tips

Catalog Number	Length (in.)
FO113R	3 3/4



FO113R

1/2



1/1

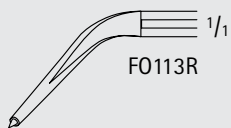

FO113R

1/1

Finger Reposition Forceps, F/ Small Fragments

Catalog Number	Length (in.)
FO115R	5 1/4



FO115R

1/2



1/1

FO115R

REILL Reposition Forceps

Catalog Number	Length (in.)
FO116R	6 3/4



FO116R

1/2

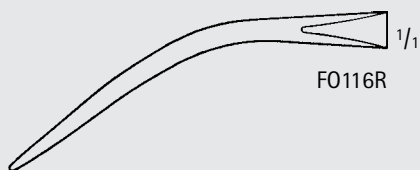

FO116R

1/1



ORTHO
SPINE

INCHES

Orthopedics/Spine

Bone Holding Forceps

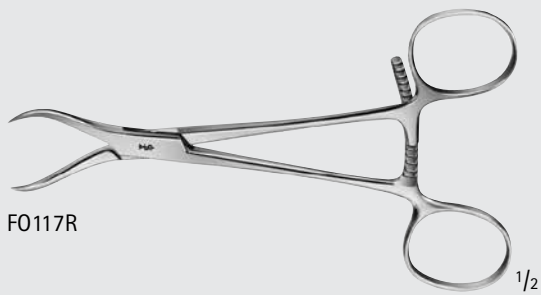

FO117R

1/2



FO117R

1/1

Forceps for Maxillary Reposition

Catalog Number	Length (in.)
FO117R	5 1/4

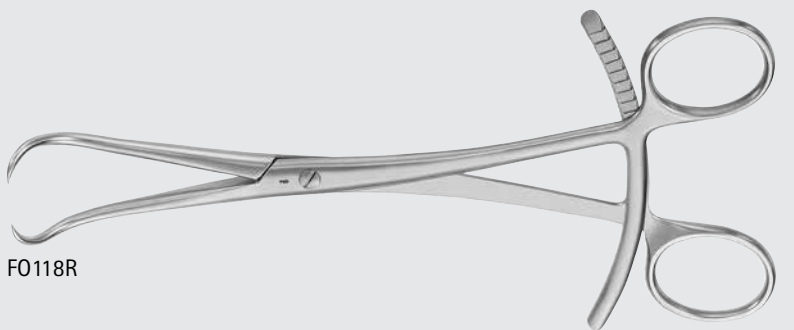

FO118R

1/2

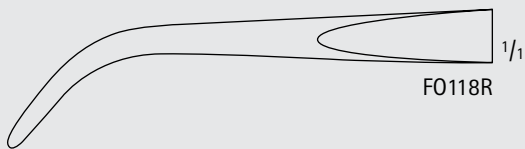

FO118R

1/1

Bone Reposition Forceps, Double Ratchet

Catalog Number	Length (in.)
FO118R	8

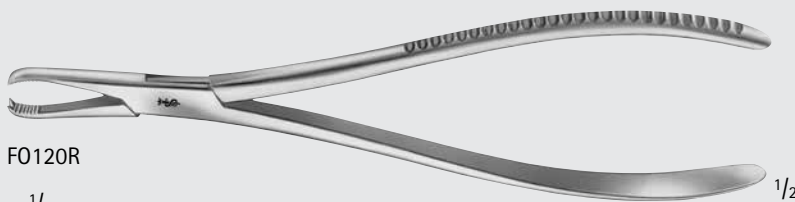

FO120R

1/2

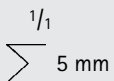

FO120R

5 mm

Bone Holding Forceps

Catalog Number	Length (in.)
FO120R	7 7/8



Bone Reduction Forceps

Catalog Number	Length (in.)
F0123R	5 1/2



F0123R

1/2



F0123R

1/16

Bone Reduction Forceps, W/ Screw Lock and Thread Fixation

Catalog Number	Length (in.)
F0124R	6 3/4
F0125R	9 1/4

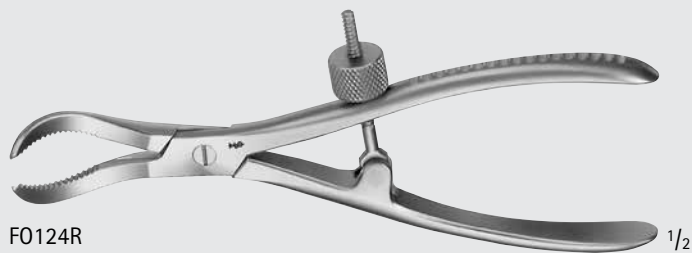

F0124R

1/2



F0125R

1/2



ORTHO
SPINE

INCHES

Orthopedics/Spine

Bone Holding Forceps



FO127R

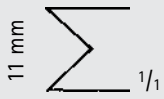

FO127R

LANGENBECK Bone Holding Forceps

Catalog Number	Tip Size (mm)	Length (in.)
FO127R	11	8



FO130R

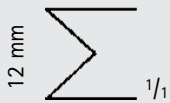

FO130R

FERGUSSON Bone Holding Forceps

Catalog Number	Tip Size (mm)	Length (in.)
FO130R	12	8



FO135R



FO135R



FO136R



FO136R

SEMB Rib/Bone Holding Forceps

Catalog Number	Tip Size (mm)	Item	Length (in.)
FO135R	8	W/O RATCHET	7 1/2
FO136R	8	W/ RATCHET	7 1/2



FARABEU F Bone Holding Forceps

Catalog Number	Tip Size (mm)	Length (in.)
FO140R	9	9
FO141R	11	10



FO140R

1/2

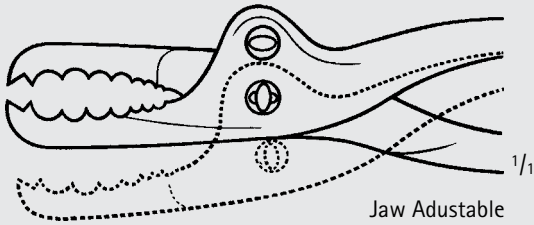

1/1

Jaw Adustable

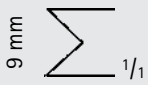

FO140R



FO141R

1/2

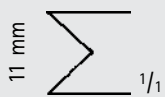

FO141R

**FARABEU F-LAMBOTTE Forceps,
W/ Ratchet**

Catalog Number	Tip Size (mm)	Length (in.)
FO143R	11	10



FO143R

1/2

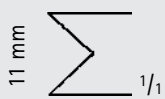

FO143R



Orthopedics/Spine

Bone Holding Forceps

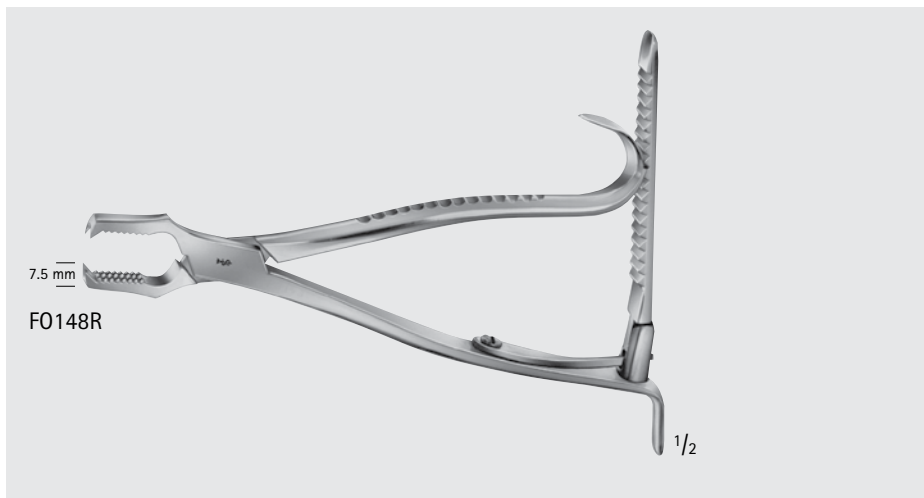

KERN Mini Bone Holding Forceps, W/ Ratchet

Catalog Number	Tip Size (mm)	Length (in.)
FO148R	7.5	6 1/8

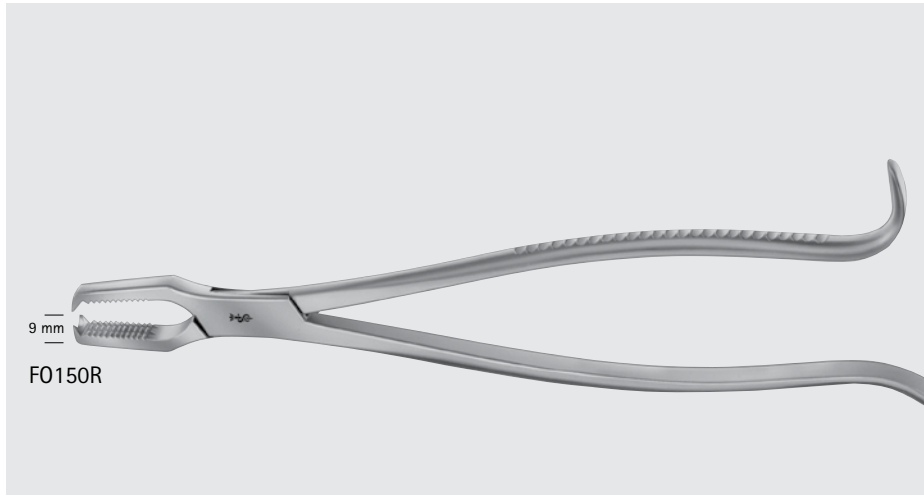

KERN-LANE Bone Holding Forceps

Catalog Number	Tip Size (mm)	Length (in.)
FO150R	9	9 1/2

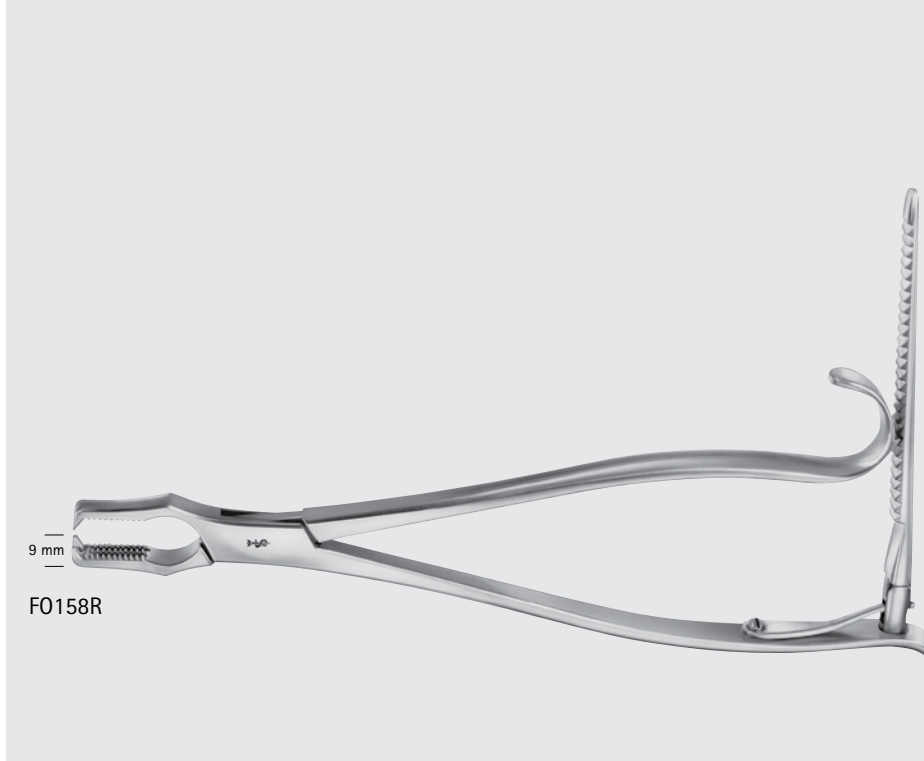

KERN-LANE Bone Holding Forceps, W/ Ratchet

Catalog Number	Tip Size (mm)	Length (in.)
FO158R	9	9 1/2

LANE Bone Holding Forceps

Catalog Number	Tip Size (mm)	Description	Length (in.)
FO151R	9	W/O RATCHET	13
FO159R	13	W/ RATCHET	12 1/2

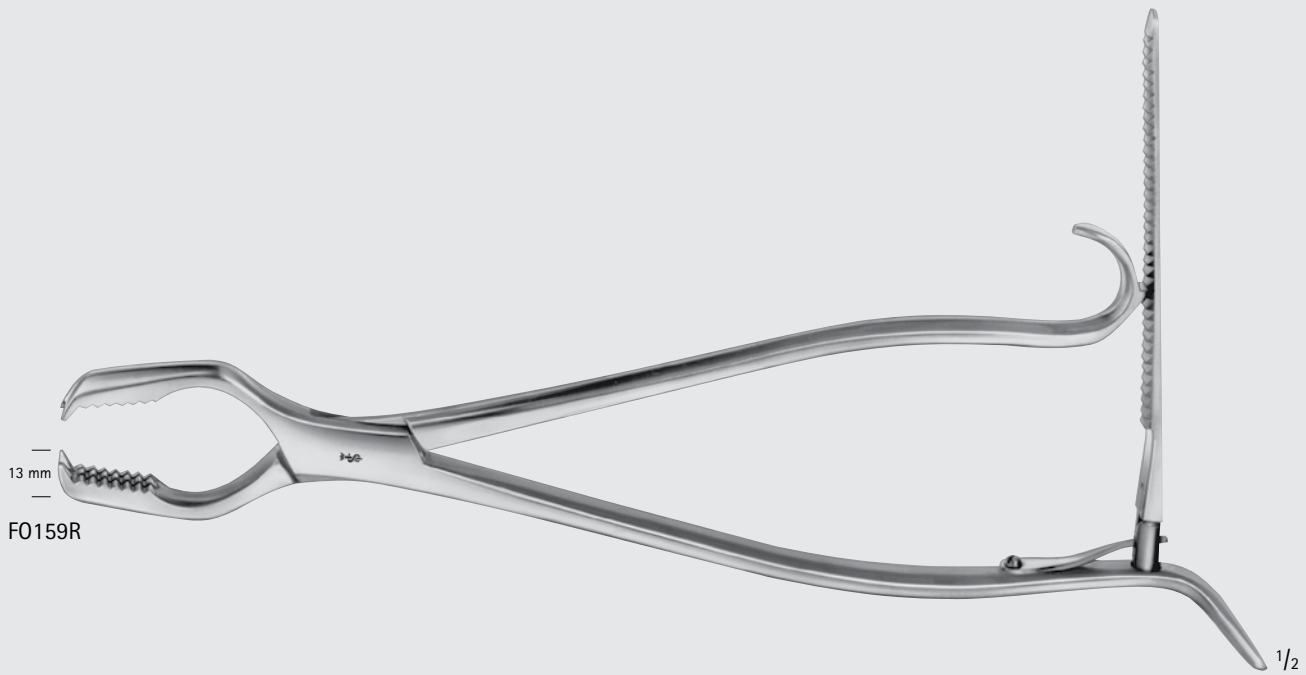
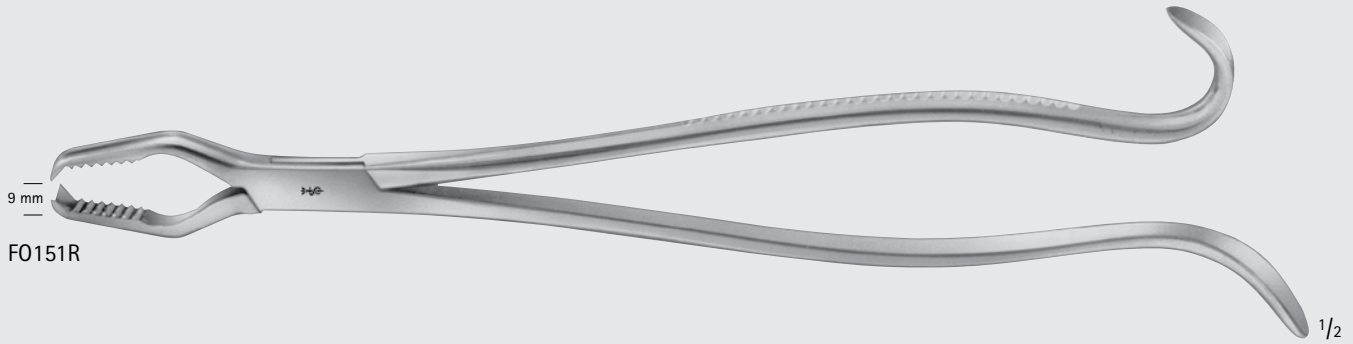

Orthopedics/Spine

Bone Holding Forceps

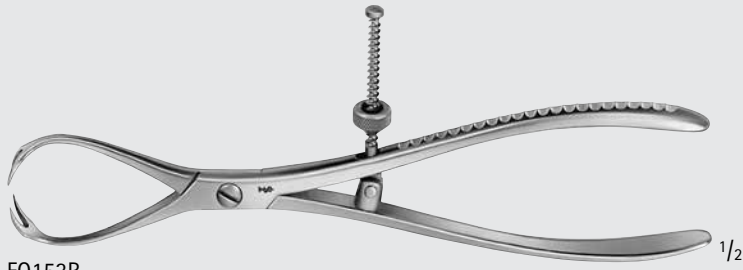

FO153R



FO153R

Patella Forceps W/ Screw Lock

Catalog Number	Length (in.)
FO153R	7 1/4



FO160R-FO162R



FO160R



FO161R



FO162R

LAMBOTTE Bone Holding Forceps, W/ Movable Jaw and Ratchet

Catalog Number	Tip Size (mm)	Length (in.)
FO160R	10	8 3/4
FO161R	13	10 1/4
FO162R	16	13





F0169R-F0173R

Self-Centering Forceps, W/ Screw Lock and Thread Fixation

Catalog Number	Tip Size (mm)	Length (in.)
F0169R	3/3	5 3/4
F0170R	7 / 2.5	7 1/2
F0171R	10.5 / 3.5	9 1/2
F0172R	11 / 3.5	10 1/4
F0173R	11.5 / 4.5	10 3/4



F0169R



F0170R

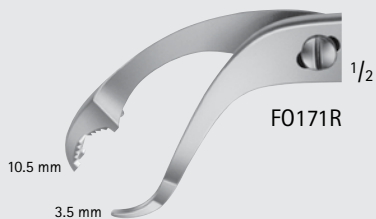

F0171R

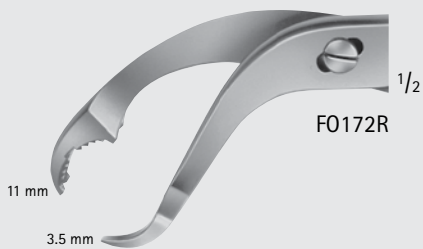

F0172R

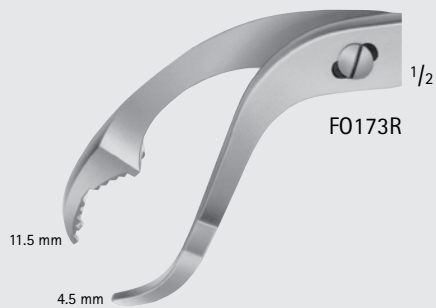

F0173R



Orthopedics/Spine

Bone Holding Forceps



FO180R



FO180R



FO181R-FO183R

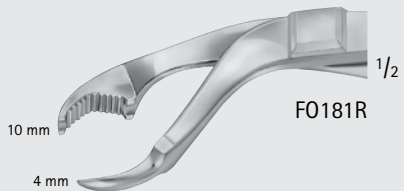

FO181R

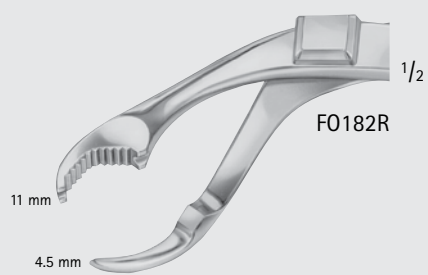

FO182R



FO183R

VERBRUGGE Bone Forceps

Catalog Number	Tip Size (mm)	Length (in.)
FO180R	5	6 7/8
FO181R	10 / 4.0	9 3/4
FO182R	11 / 4.5	10 1/2
FO183R	12 / 4.5	10 5/8



FO190R-FO191R

LOWMAN Bone Clamp

Catalog Number	Length (in.)
FO190R	6 7/8
FO191R	8



FO192R

LOWMAN-GERSTER Bone Clamp

Catalog Number	Length (in.)
FO192R	8 1/4



FO193R

LOWMAN-HOGLUND Bone Clamp

Catalog Number	Length (in.)
FO193R	6 7/8



ORTHO
SPINE

Orthopedics/Spine

Bone Holding Forceps

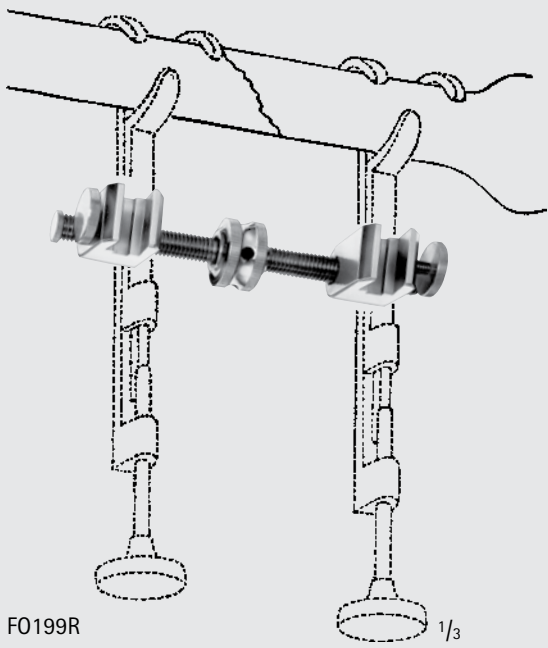

FO199R

1/3

GERSTER Traction Bar
F/FO190R-FO193R

Catalog Number
FO199R

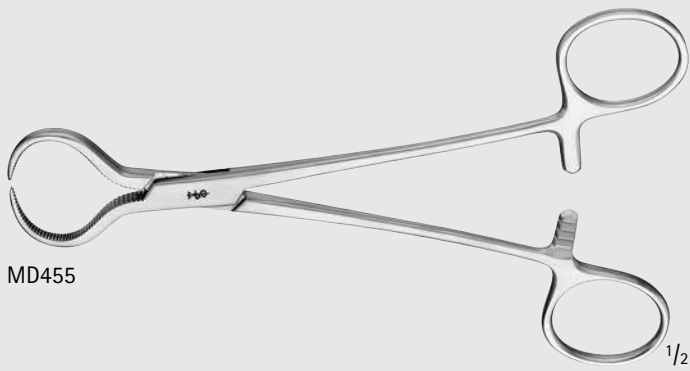

MD455

1/2

LEWIN Bone Clamp

Catalog Number	Tip	Length (in.)
MD455	SERR	7



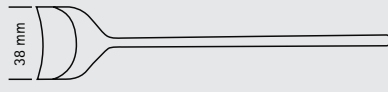
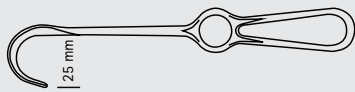

Dimensions for blade size of retractors
 1st number = depth Example: 25 x 38 mm
 2nd number = width



Knee Retractor

Catalog Number	Blade Size (mm)	Length (in.)
BT419R	39 x 9	8 7/8

BT419R

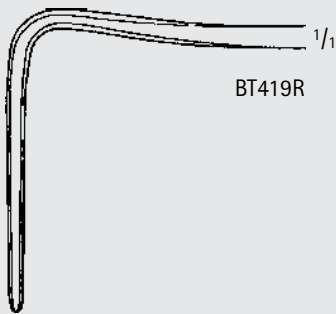

BT419R

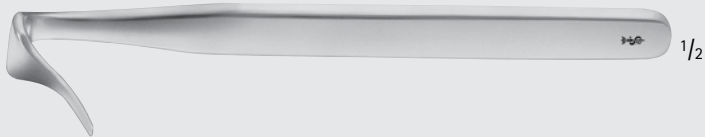

BLOUNT Knee Retractor

Catalog Number	Blade Size (mm)	Length (in.)
BT420R	40 x 4	6 7/8

BT420R

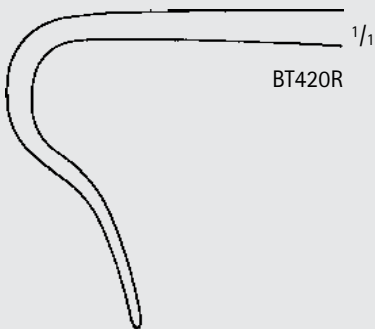

BT420R



ORTHO
SPINE

INCHES

Orthopedics/Spine

Retractors



BT430R

Knee Retractor

Catalog Number	Blade Size (mm)	Length (in.)
BT430R	56 x 10	6 3/4

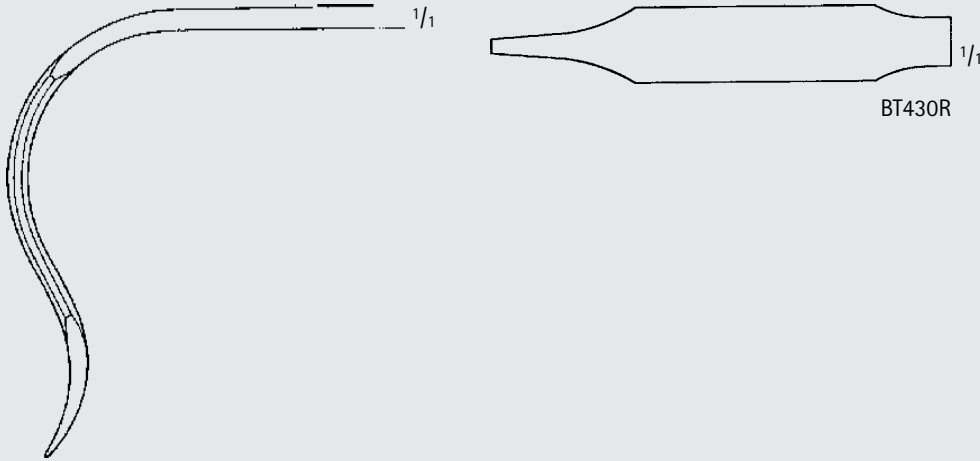

BT430R



MB976R

DOANE "Z" Knee Retractor

Catalog Number	Blade Size (mm)	Size
MB976R	55 x 75	MEDIUM
MB977R	66 x 80	LARGE



MB977R



T-Handle Retractor

Catalog Number	Blade Size (mm)	Length (in.)
MD512R	120 x 32	7
MD513R	120 x 32	11
MD514R	120 x 32	13



MD512R-MD514R

HIBBS Retractor

Catalog Number	Blade Size (mm)	Length (in.)
BT503R	25 x 75	9 1/8
BT504R	20 x 50	9 1/8
BT505R	13 x 25	9 1/8



BT503R-BT505R



BT503R



BT504R



BT505R



INCHES

Orthopedics/Spine

Retractors



BT501R-BT502R

TAYLOR Spinal Retractor

Catalog Number	Blade Size (mm)	Length (in.)
BT501R	30 x 70	7 1/4
BT502R	30 x 100	7 7/8



1/1

BT501R



1/1

BT502R



BT421R-BT425R

SMILLIE Retractor

Catalog Number	Blade Size (mm)	Length (in.)
BT421R	32 x 19	5 1/2
BT422R	48 x 19	5 1/2
BT423R	57 x 19	5 1/2
BT424R	52 x 13	5 1/2
BT425R	12 x 13	5 1/2

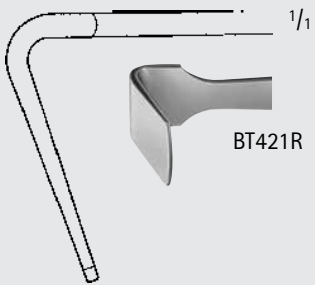

BT421R

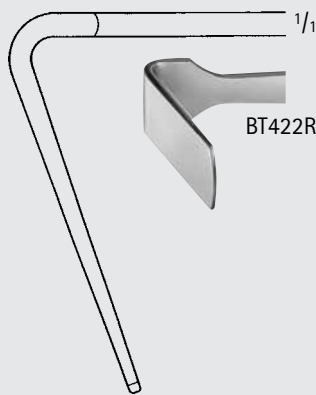

BT422R

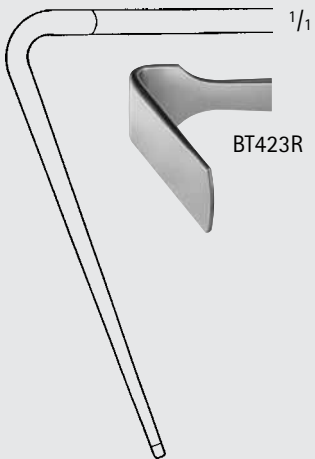

BT423R

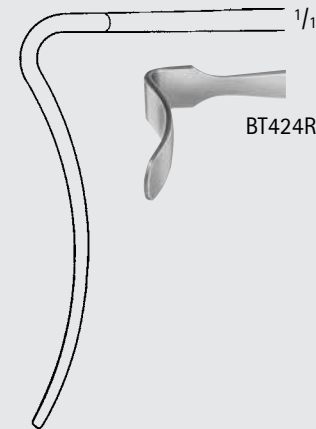

BT424R

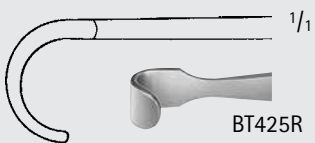

BT425R



INCHES

Orthopedics/Spine

Retractors

MEYERDING Retractor

Catalog Number	Blade Size (mm)	Length (in.)
BT485R	52 x 16	9
BT486R	76 x 25	9
BT487R	89 x 50	10

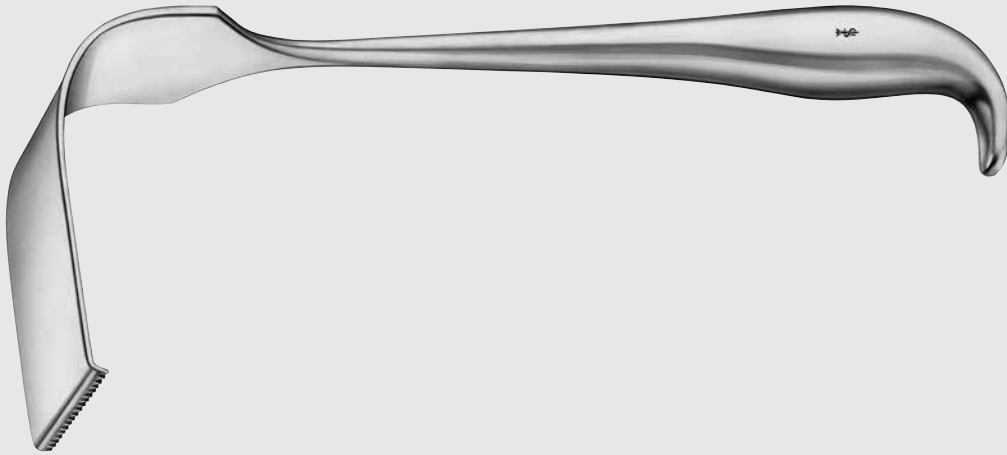

BT485R-BT487R

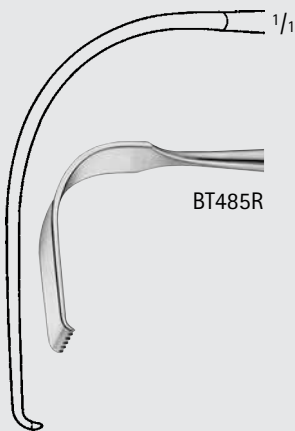

BT485R

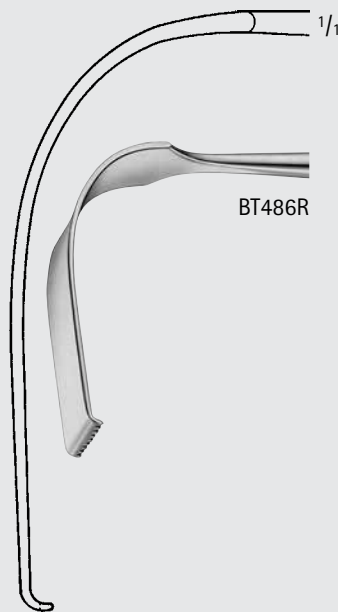

BT486R

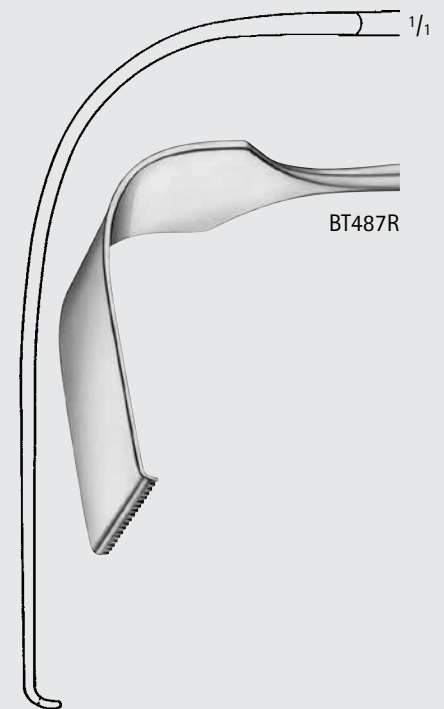

BT487R



AUFRANC Cobra Retractor

Catalog Number	Tip	Length (in.)
MB448R	SMOOTH, POINTED	10
MB514R	SMOOTH, BLUNT	10



MB448R-MB514R

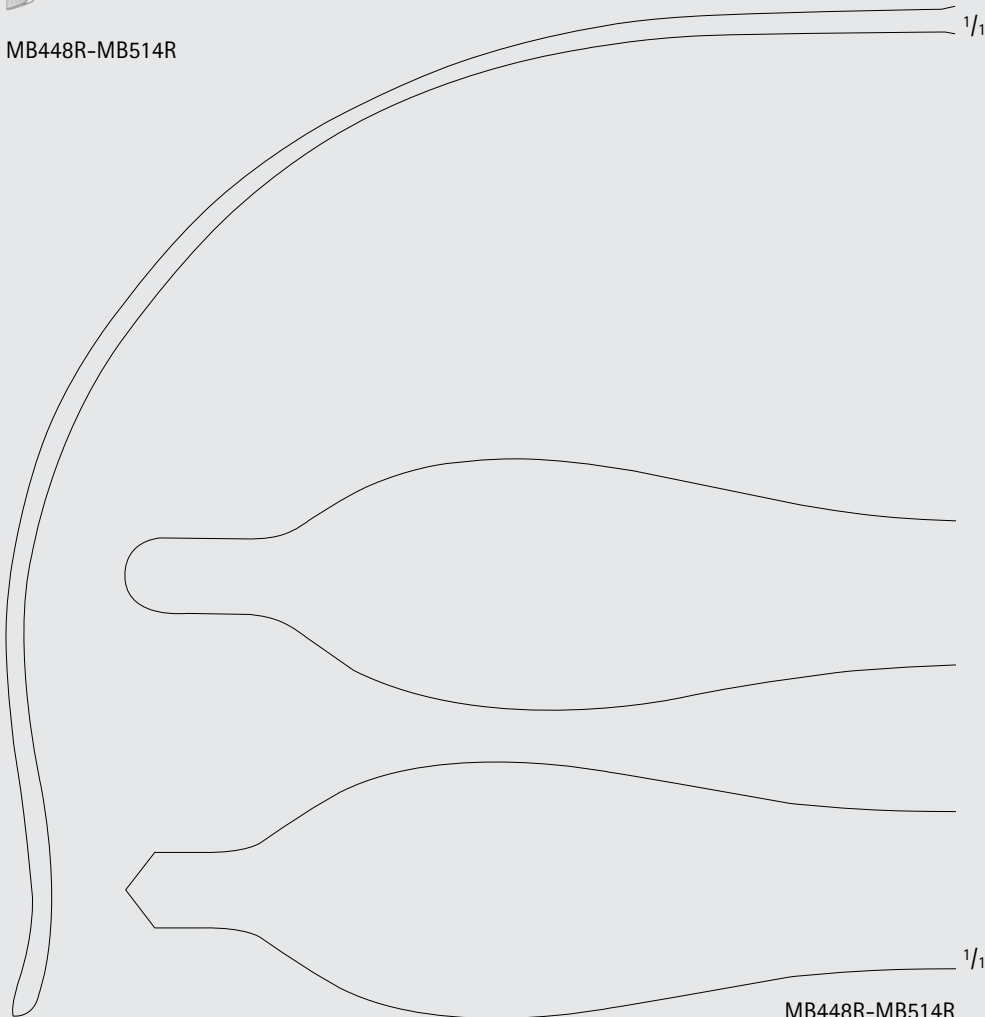

MB448R-MB514R



Orthopedics/Spine

Retractors



AUFRANC Cobra Retractor

Catalog Number	Tip	Length (in.)
MB379R	SERR, BLUNT	10

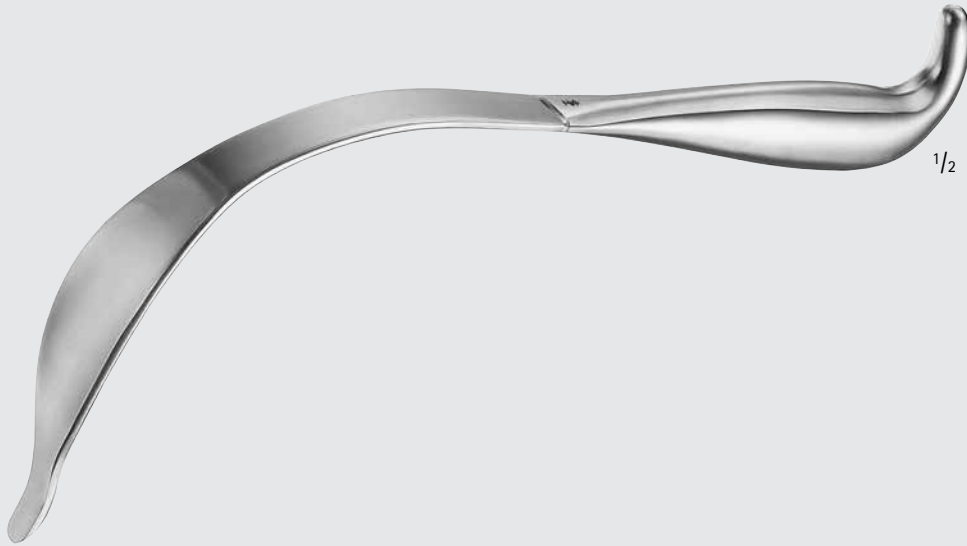

MB379R

1/2

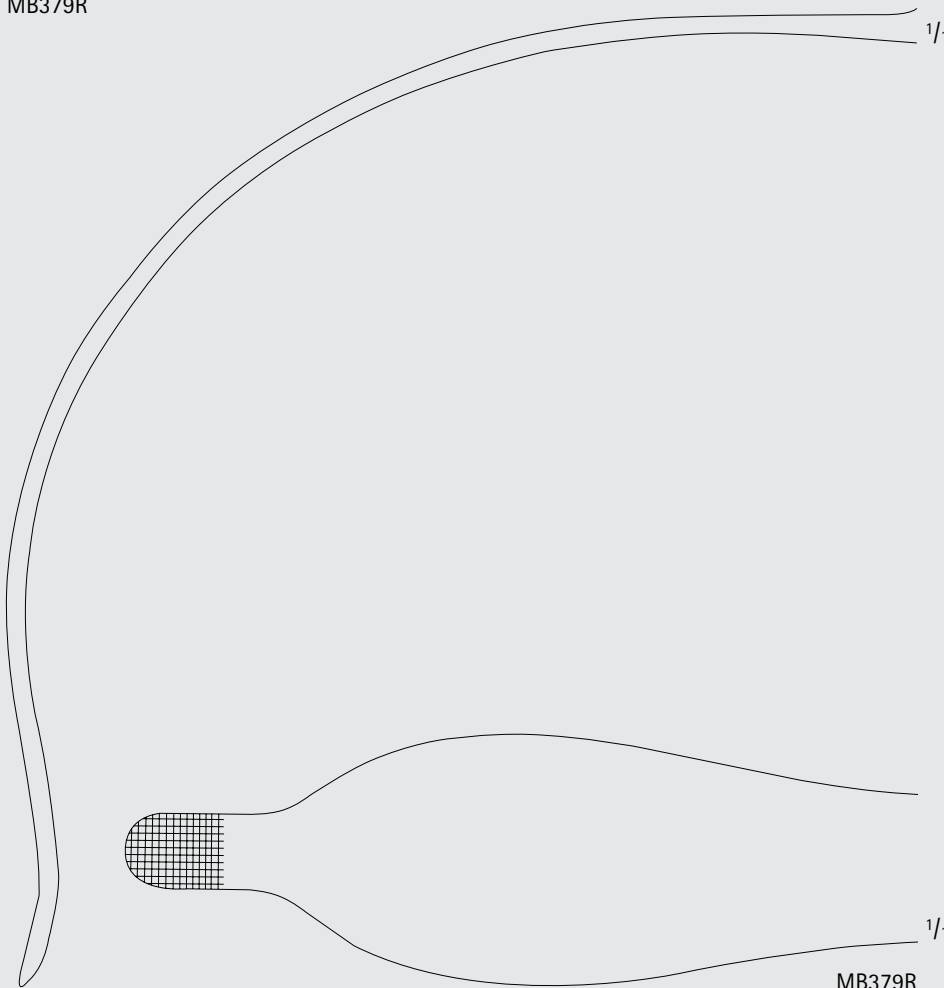

1/1

1/1

MB379R



MF058R-MF060R

**CLOWARD Style Cervical Retractor
W/ Lip**

Catalog Number	Width (mm)	Length (in.)
MF058R	18	7
MF059R	20	7
MF060R	23	7

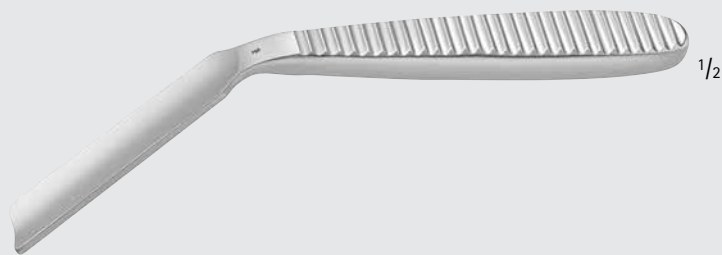

MN073R-MN075R

**CLOWARD Style Cervical Retractor
W/O Lip**

Catalog Number	Width (mm)	Length (in.)
MN073R	18	7
MN074R	20	7
MN075R	23	7



Orthopedics/Spine

Retractors



FK110R

1/2



1/1

5.5 mm

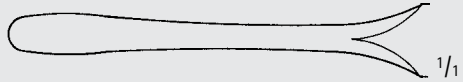

FK110R



FK111R

1/2

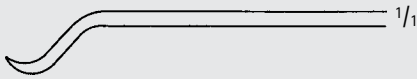

1/1

2.8 mm

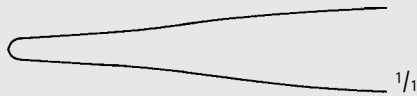

1/1

FK111R



FK113R

1/2

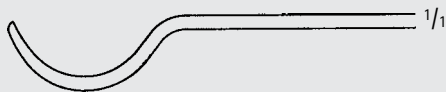

1/1

4.5 mm

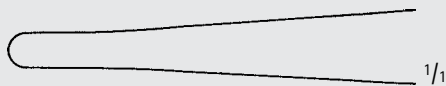

1/1

FK113R

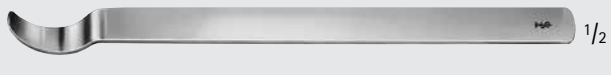

FK114R

1/2

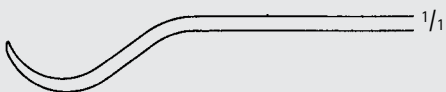

1/1

7 mm

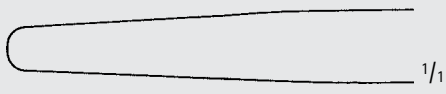

1/1

FK114R

HAYES Bone Retractor

Catalog Number	Blade Size (mm)	Length (in.)
FK110R	5.5	6 1/8
FK111R	2.8	5 1/2
FK113R	4.5	6
FK114R	7	6

BUCK-GRAMCKO Bone Retractor

Catalog Number	Blade Size (mm)	Length (in.)
FK116R	2/7.5	6

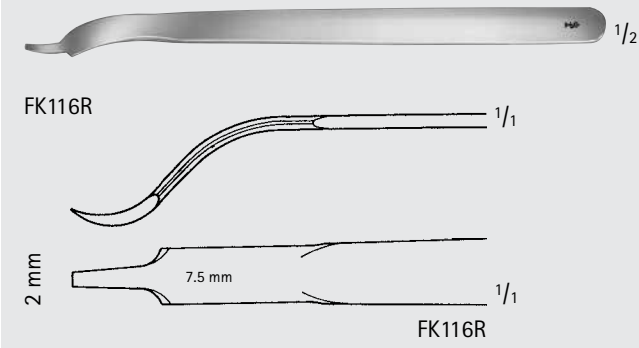

HOHMANN Bone Retractor

Catalog Number	Blade Size (mm)	Length (in.)
FK117R	2/6	6 1/4
FK118R	2/8	6 1/4
MB449R	2/15	6

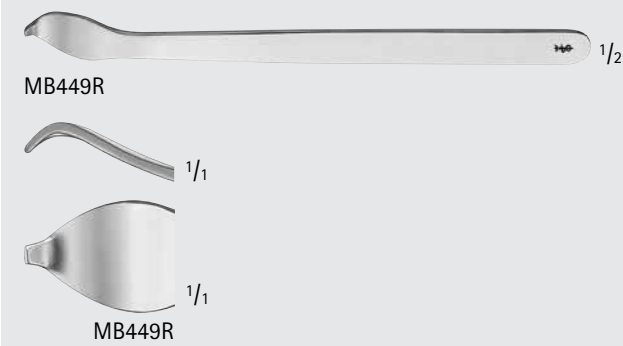
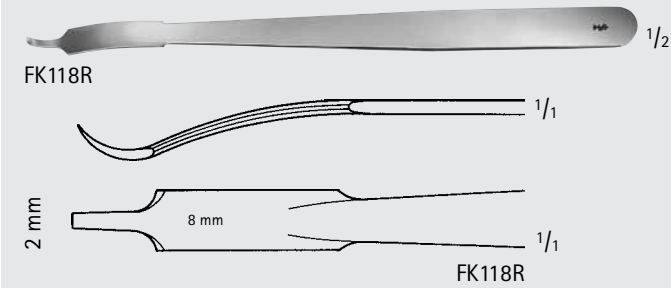
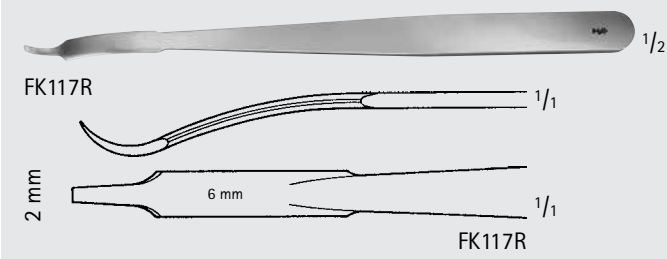

Baby HOHMANN Retractor

Catalog Number	Blade Size (mm)	Length (in.)
FK119R	2/15	5

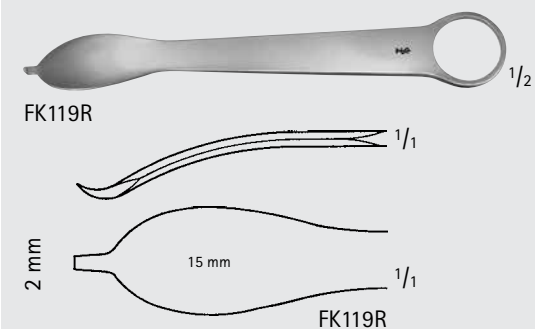

Orthopedics/Spine

Retractors



FK170R

1/2

HOHMANN Bone Retractor

Catalog Number	Blade Size (mm)	Length (in.)
FK170R	9	8 3/4
FK166R	17	9 1/2



1/1

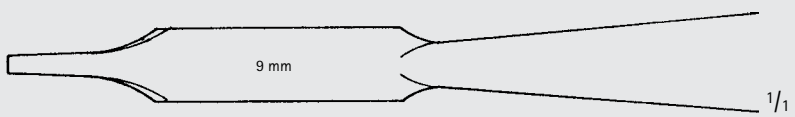

9 mm

1/1

FK170R



FK166R

1/2



1/1

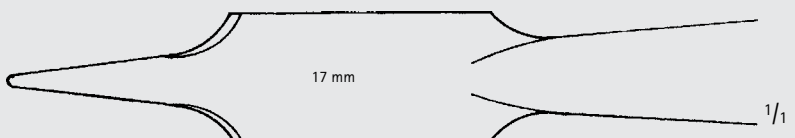

17 mm

1/1

FK166R

HOHMANN Bone Retractor (continued)

Catalog Number	Blade Size (mm)	Length (in.)
FK171R	18	9 1/2
FK176R	25	10 5/8

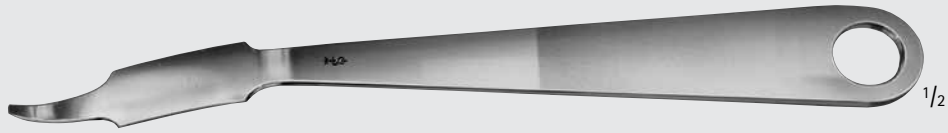

FK171R

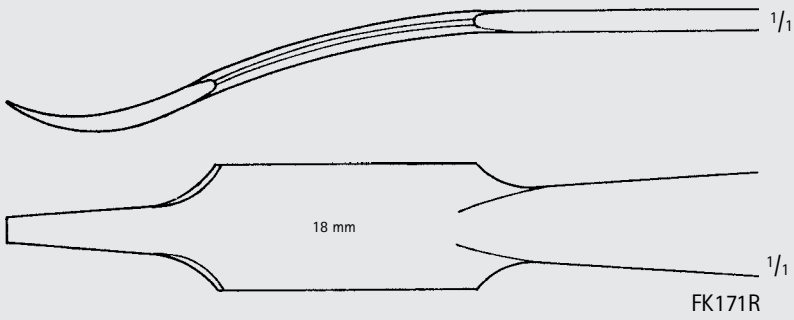

FK176R

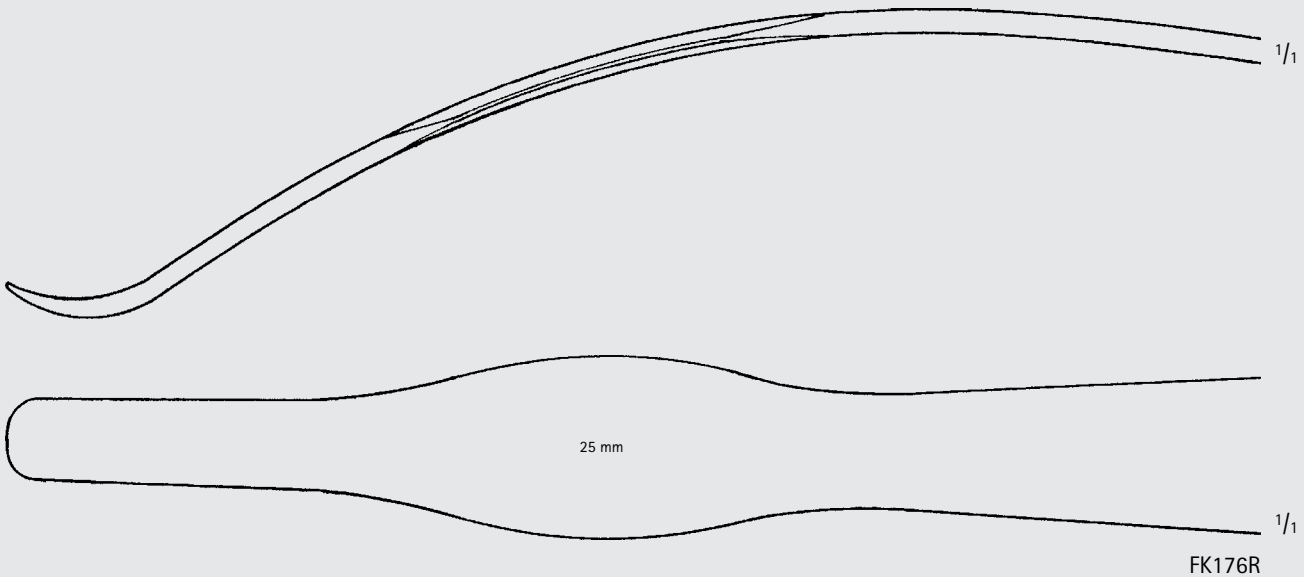

ORTHO
SPINE

Orthopedics/Spine

Retractors

HOHMANN Bone Retractor (continued)

Catalog Number	Blade Size (mm)	Length (in.)
FK172R	24	10 1/4
FK173R	34	11 1/4



FK172R-FK173R

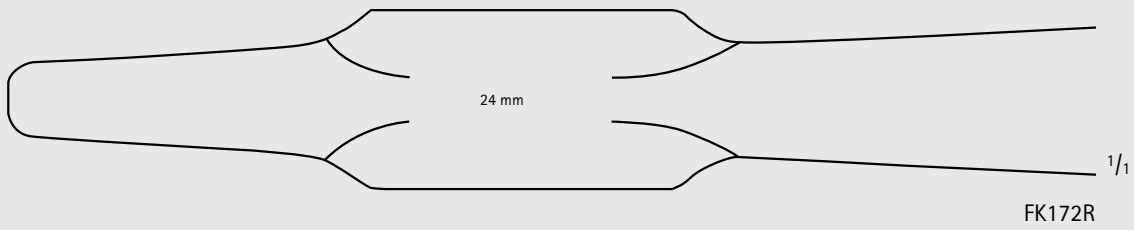
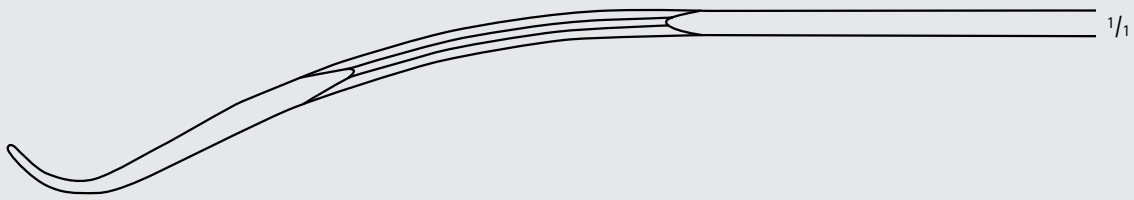

FK172R

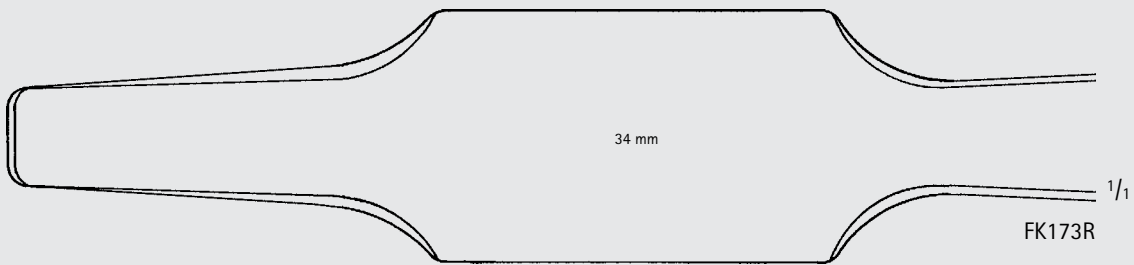
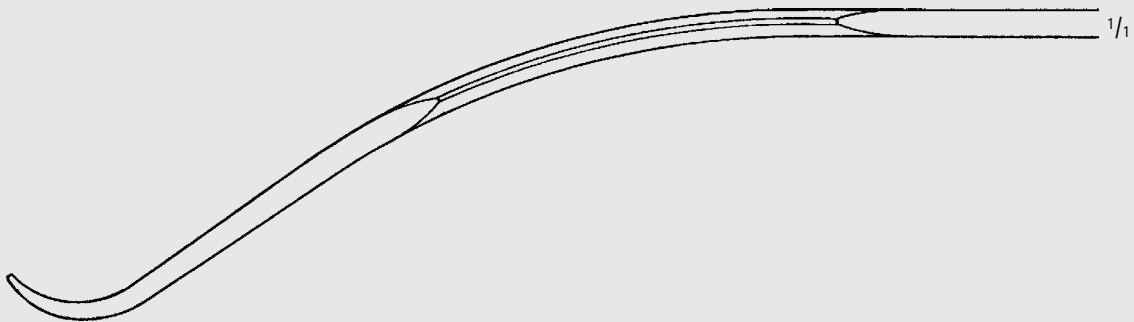

FK173R



LANGE-HOHMANN Bone Retractor

Catalog Number	Blade Size (mm)	Length (in.)
FK160R	24	9 3/4



FK160R

1/2



1/1

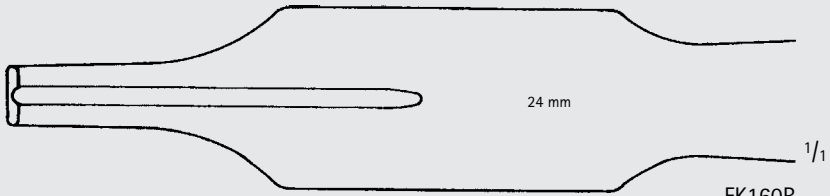

24 mm

1/1

FK160R



ORTHO
SPINE

INCHES

Orthopedics/Spine

Retractors

LANGE-HOHMANN Bone Retractor (continued)

Catalog Number	Blade Size (mm)	Length (in.)
FK161R	30	10 1/2
FK162R	33	11



FK161R-FK162R

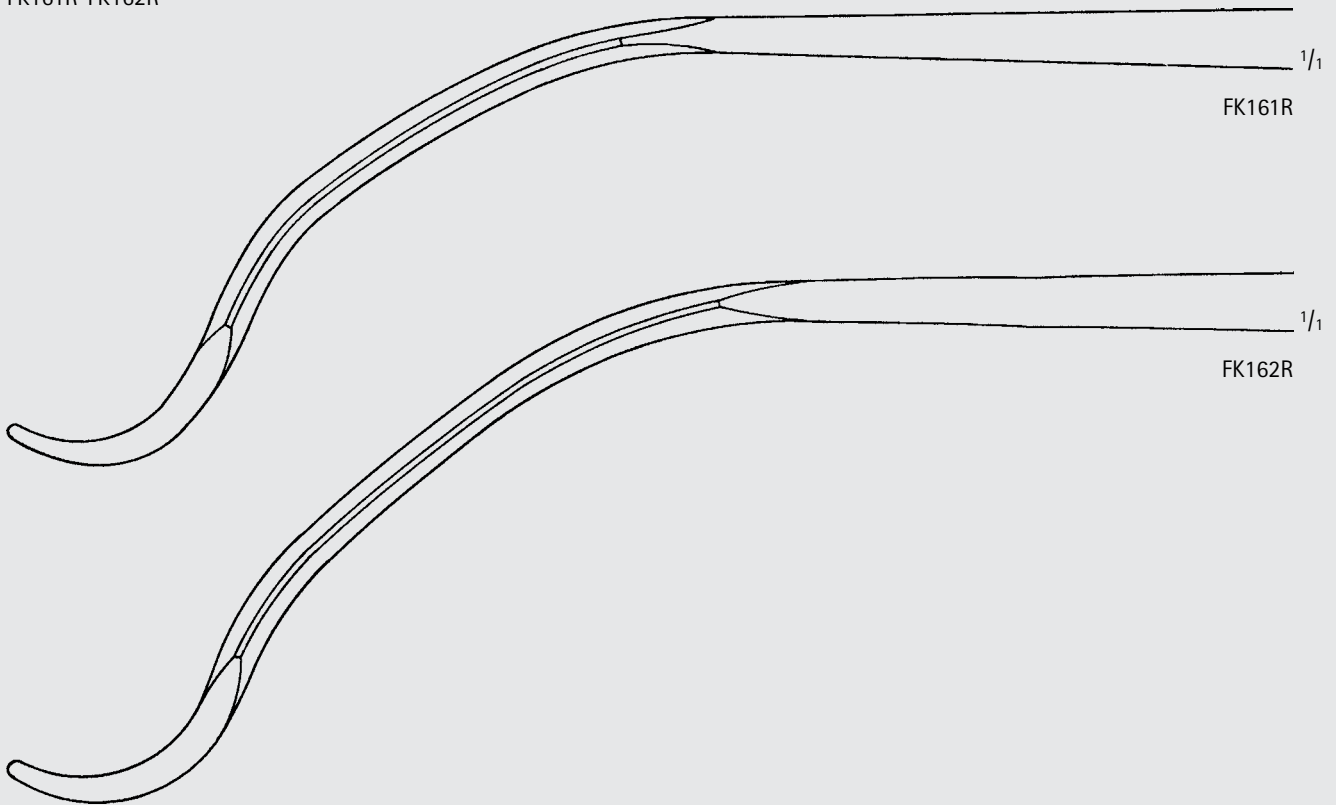

FK161R

FK162R

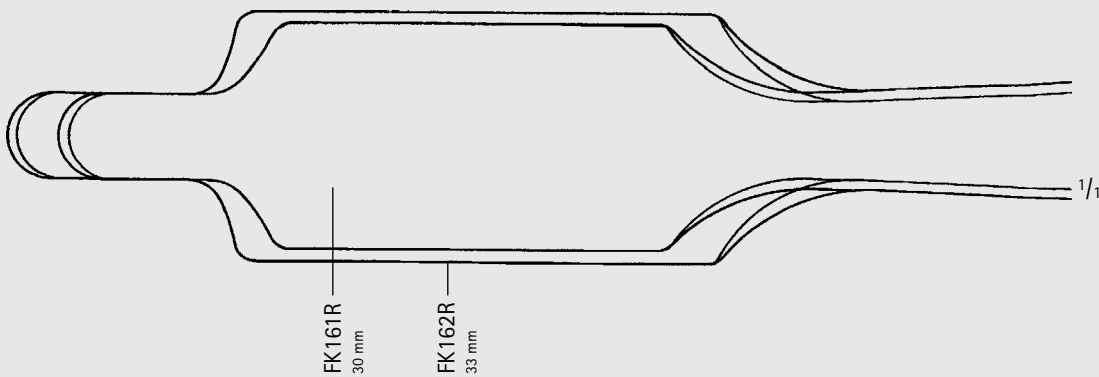

FK161R
30 mm

FK162R
33 mm



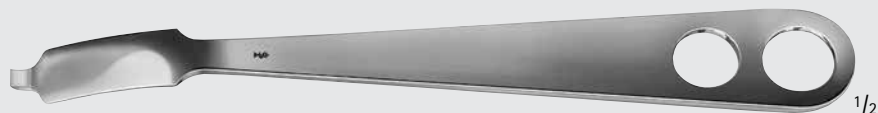

FK167R

HOHMANN (WAGNER) Humoral Head Retractor

Catalog Number	Blade Size (mm)	Length (in.)
FK167R	17	8 3/4

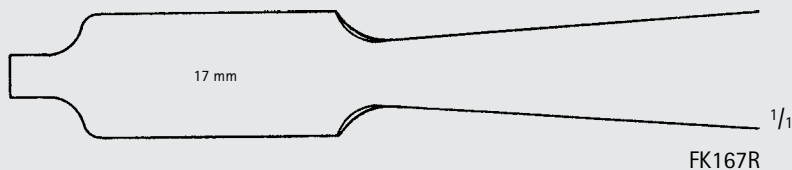
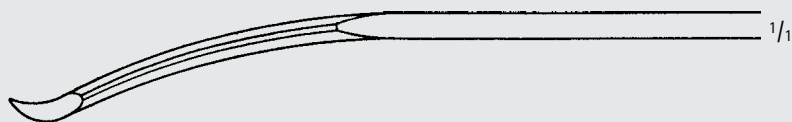

FK169R

HOHMANN (ALDINGER) Bone Retractor

Catalog Number	Blade Size (mm)	Length (in.)
FK169R	24	10 5/8

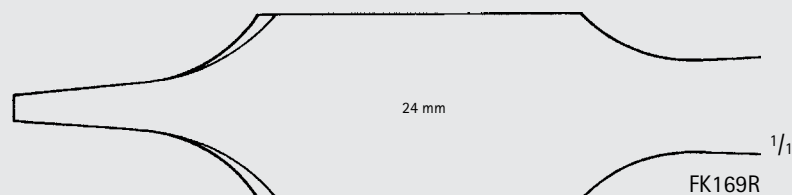
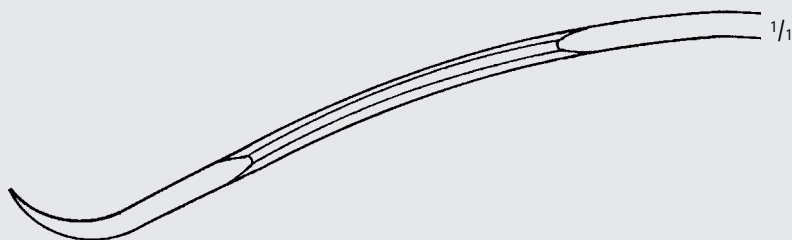

Orthopedics/Spine

Retractors



FK185R-FK187R

HOHMANN Bone Retractor

Catalog Number	Blade Size (mm)	Length (in.)
FK185R	8	8 3/4
FK186R	15	9 3/4
FK187R	22	11 3/4

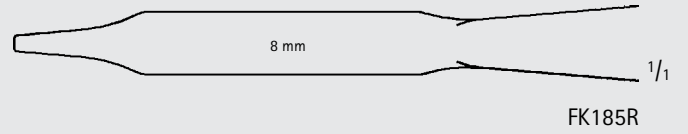

FK185R

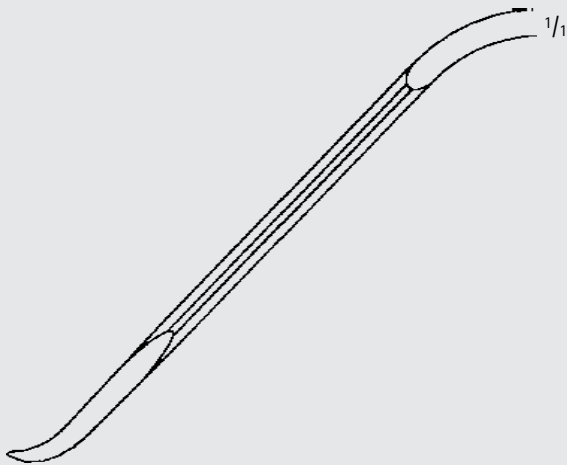

FK186R

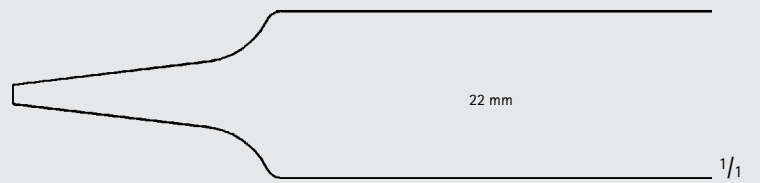
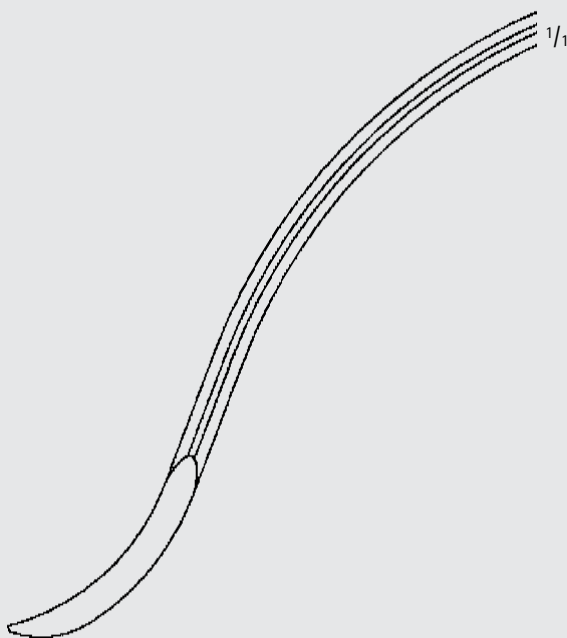

FK187R

HOHMANN Bone Retractor (continued)

Catalog Number	Blade Size (mm)	Length (in.)
FK188R	43	9

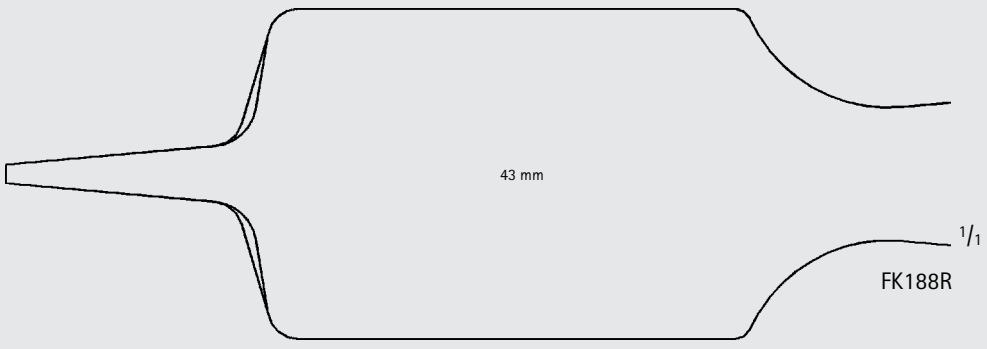
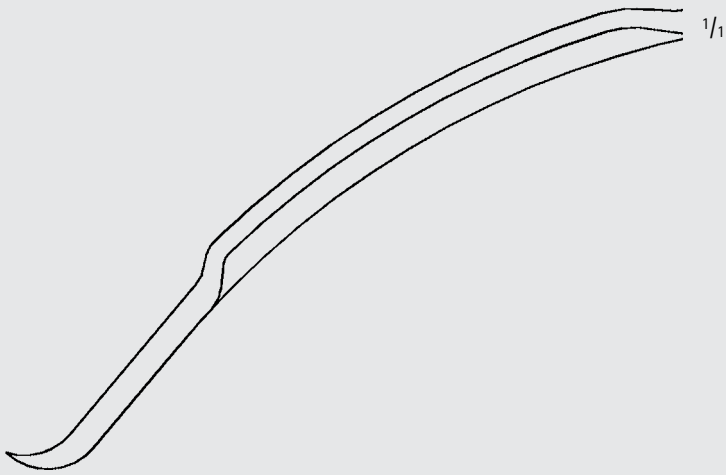

Orthopedics/Spine

Retractors

HOHMANN Bone Retractor (continued)

Catalog Number	Blade Size (mm)	Length (in.)
FK189R	40	11 1/2



FK189R

$1/1$

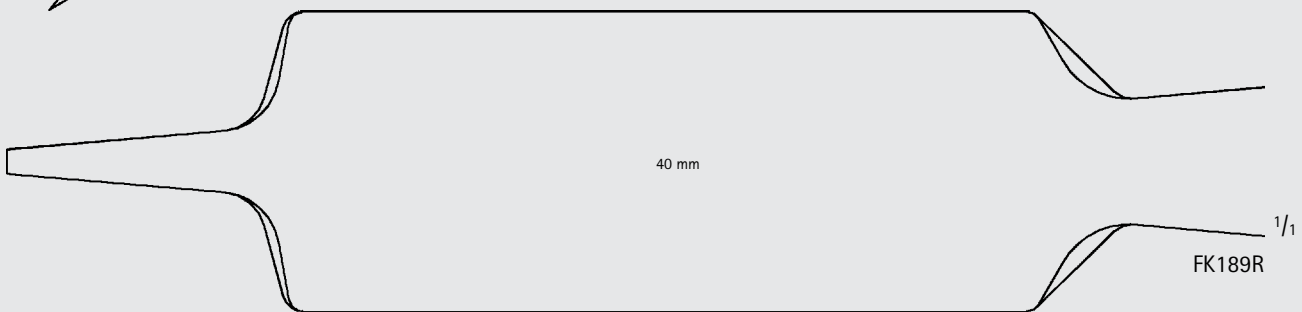

40 mm

$1/1$
FK189R



**SCHUMACHER Modified WAGNER
Bone Retractor**

Catalog Number	Blade Size (mm)	Length (in.)
FK168R	37	14



FK168R

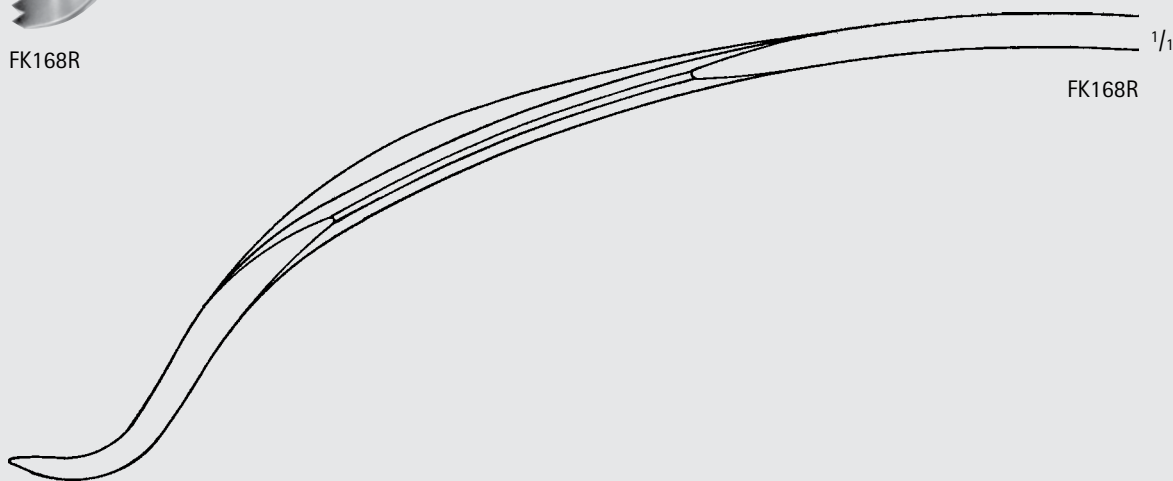

SCHUMACHER Bone Retractor

Catalog Number	Blade Size (mm)	Length (in.)
FK177R	35	11 1/2



FK177R

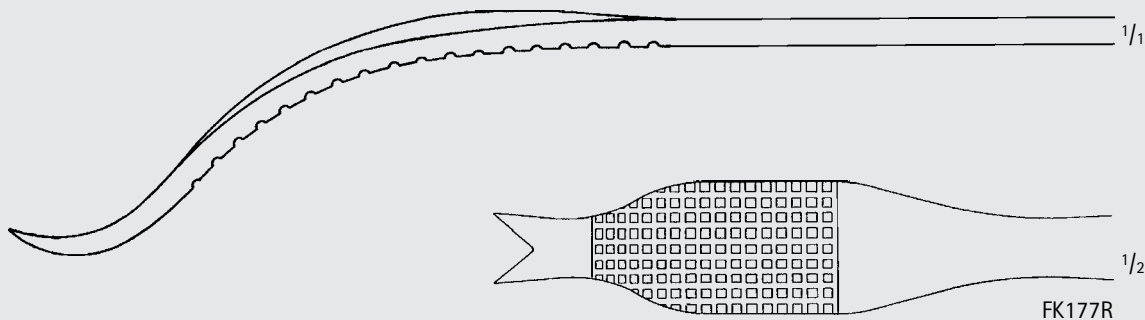

Orthopedics/Spine

Retractors

VERBRUGGE-MÜLLER Bone Retractor

Catalog Number	Blade Size (mm)	Length (in.)
FK174R	44	9 1/2
FK175R	65	10



FK174R-FK175R

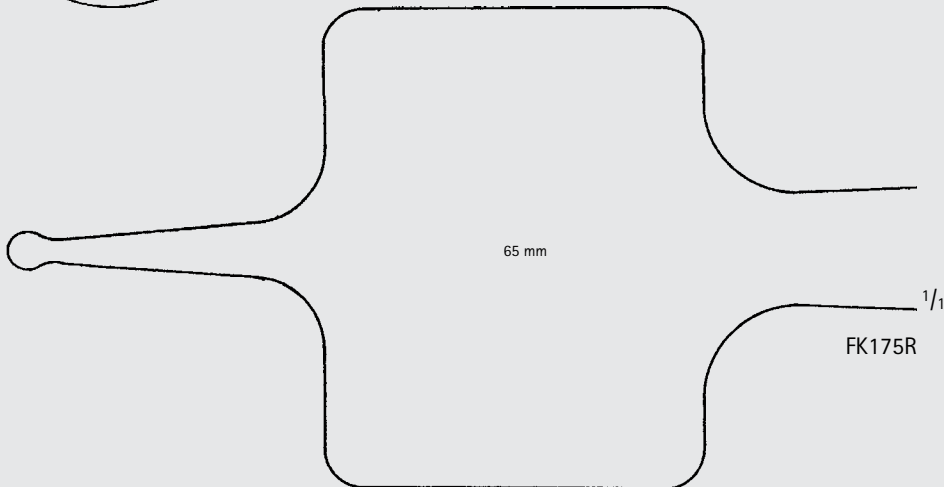
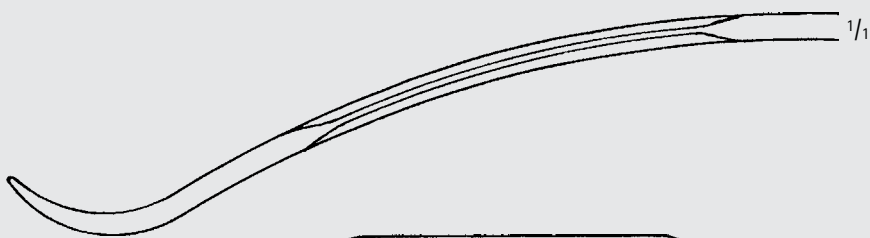
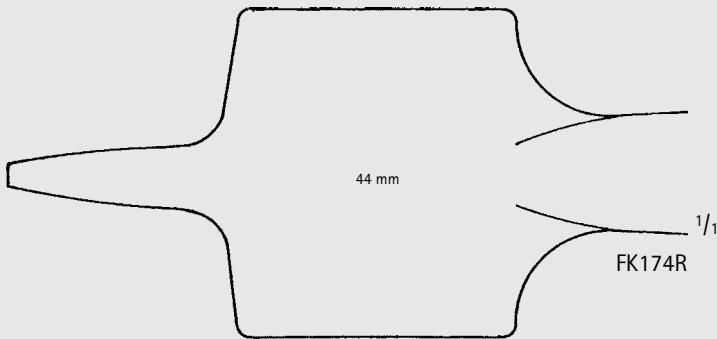
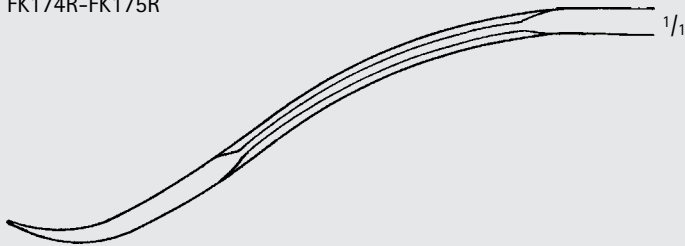

BENNETT Bone Retractor

Catalog Number	Blade Size (mm)	Length (in.)
FK180R	65	9 1/2
MD563	44	9 1/2



FK180R, MD563

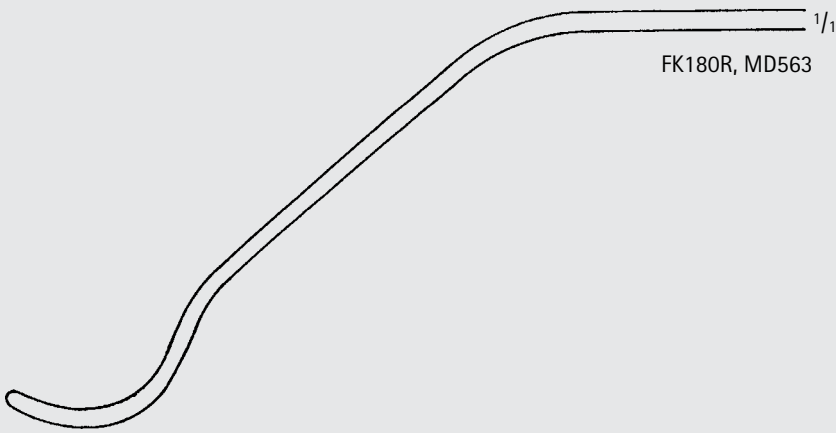

FK180R, MD563

MURPHY-LANE Bone Skid

Catalog Number	Blade Size (mm)	Length (in.)
FK193R	18 / 30	11 3/4



FK193R

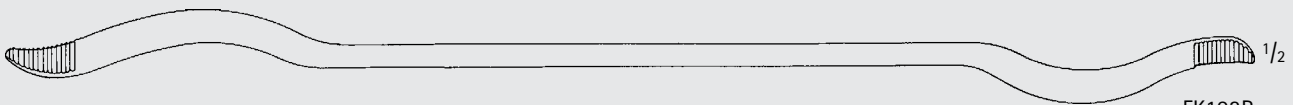

FK193R



INCHES

Orthopedics/Spine

Retractors



Bone Hook

Catalog Number	Tip	Blade End	Length (in.)
BT232R	SHARP	1 PRONG	9 5/8



BT232R

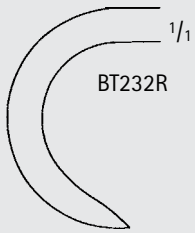

BT232R



BT234R

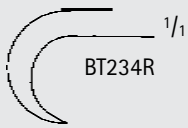

BT234R

KOCHER Bone Hook

Catalog Number	Tip	Blade End	Length (in.)
BT234R	SHARP	1 PRONG	8
BT238R	SHARP	1 PRONG	8 3/4
BT239R	BLUNT	1 PRONG	8 3/4



BT238R

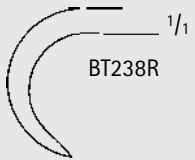

BT238R



BT239R

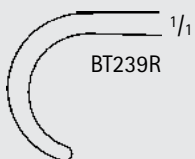

BT239R



BT240R

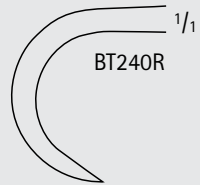

BT241R

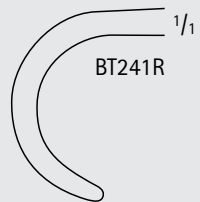

VOLKMANN Bone Hook

Catalog Number	Tip	Blade End	Length (in.)
BT240R	SHARP	1 PRONG	8 3/4
BT241R	BLUNT	1 PRONG	8 3/4

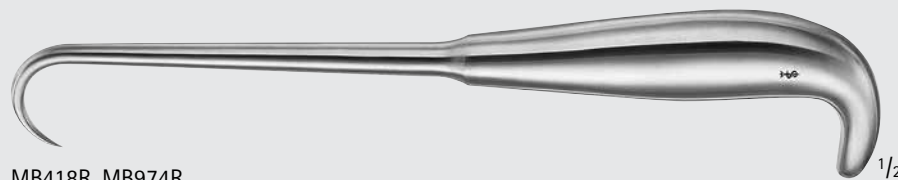

MB418R, MB974R

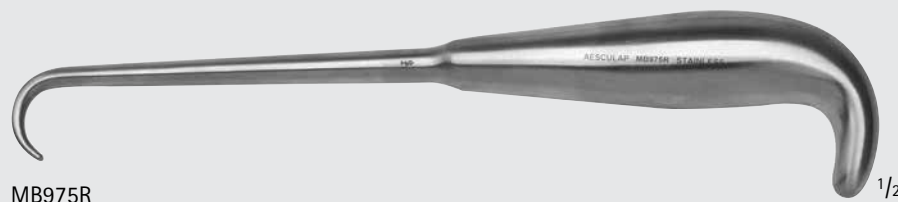

MB975R

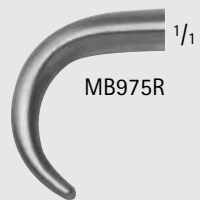

Bone Hooks

Catalog Number	Tip	Diameter (mm)	Length (in.)
MB974R	SHARP	19	9
MB975R	BLUNT	19	9
MB418R	SHARP	30	9



ORTHO
SPINE

INCHES

Orthopedics/Spine

Retractors



ANDERSON-ADSON Retractor

Catalog Number	Tip	Blade End	Length (in.)
BV250R	SHARP	4 x 4 PRONGS	7 1/2

BV250R $1/2$ BV250R $1/16$

NORFOLK-NORWICH Retractor

Catalog Number	Tip	Blade End	Length (in.)
BV248R	BLUNT	4 x 5 PRONGS	8 3/4

BV248R $1/2$ BV248R $1/16$

ADSON Self Retaining Retractor

Catalog Number	Tip	Blade End	Length (in.)
BV252R	SHARP	3 x 4 PRONGS	10 1/2

BV252R $1/2$ BV252R $1/16$

Laminectomy Self Retaining Retractor

Catalog Number	Tip	Blade End	Length (in.)
BV254R	SHARP	6 x 6 PRONGS	11



BV254R

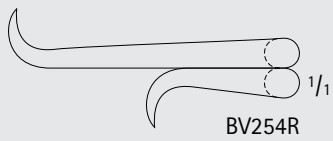

BV254R

ADSON Self Retaining Retractor, Hinged

Catalog Number	Tip	Blade End	Length (in.)
BV251R	SEMI-S	4 x 4 PRONGS	8 1/2



BV251R

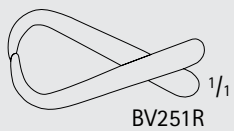

BV251R



Orthopedics/Spine

Retractors

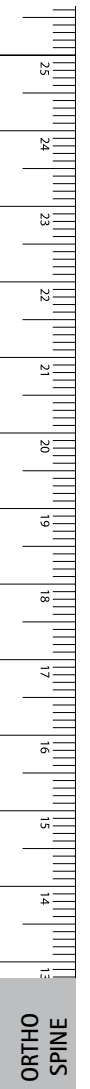

HARVEY-JACKSON Retractor, Hinged

Catalog Number	Tip	Blade End	Length (in.)
BV258R	SHARP	3 x 3 PRONGS	11 3/4

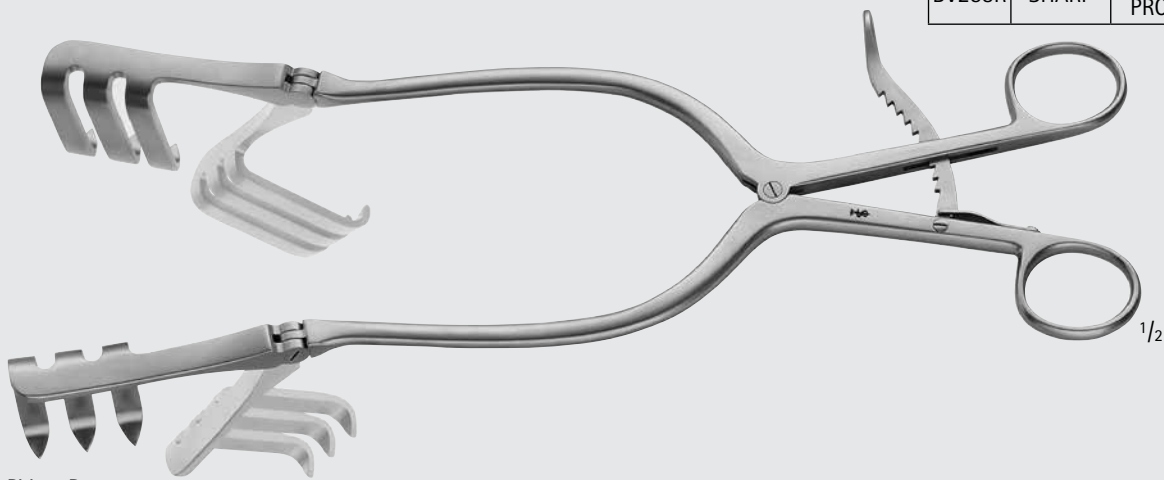

BV258R

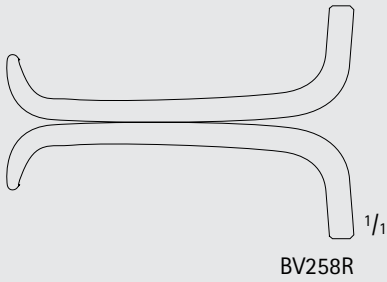

BV258R

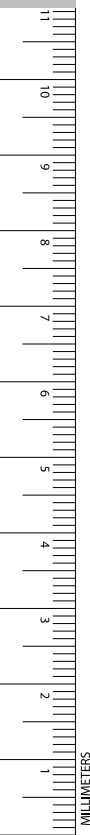

BECKMANN-ADSON Retractor, Hinged

Catalog Number	Tip	Blade End	Length (in.)
BV271R	SEMI-S	4 x 4 PRONGS	12 1/4
BV272R	SHARP	4 x 4 PRONGS	12 1/4

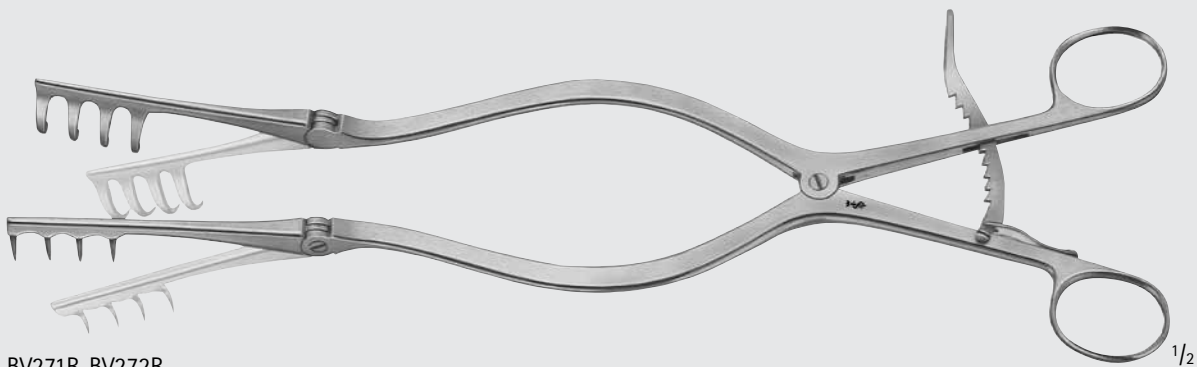

BV271R-BV272R

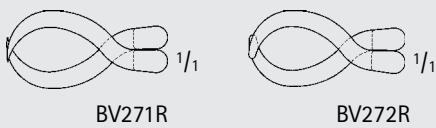

BV271R

BV272R

ADSON Retractor, Hinged

Catalog Number	Tip	Blade End	Length (in.)
BV273R	SEMI-S	5 x 4 PRONGS	12 1/2

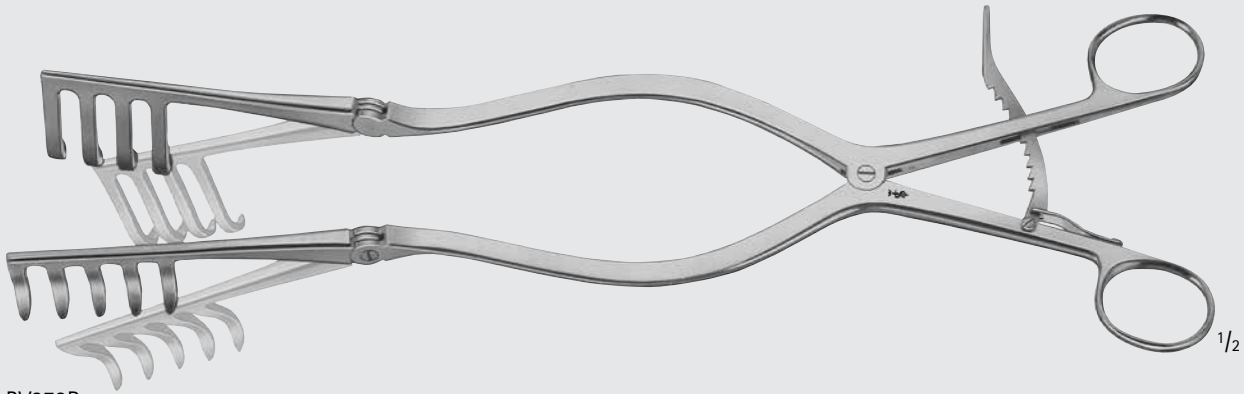

BV273R

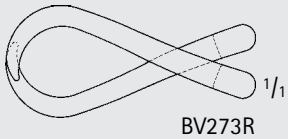

BV273R

BECKMANN Retractor, Hinged

Catalog Number	Tip	Blade End	Length (in.)
BV276R	SHARP	7 x 7 PRONGS	12 1/2

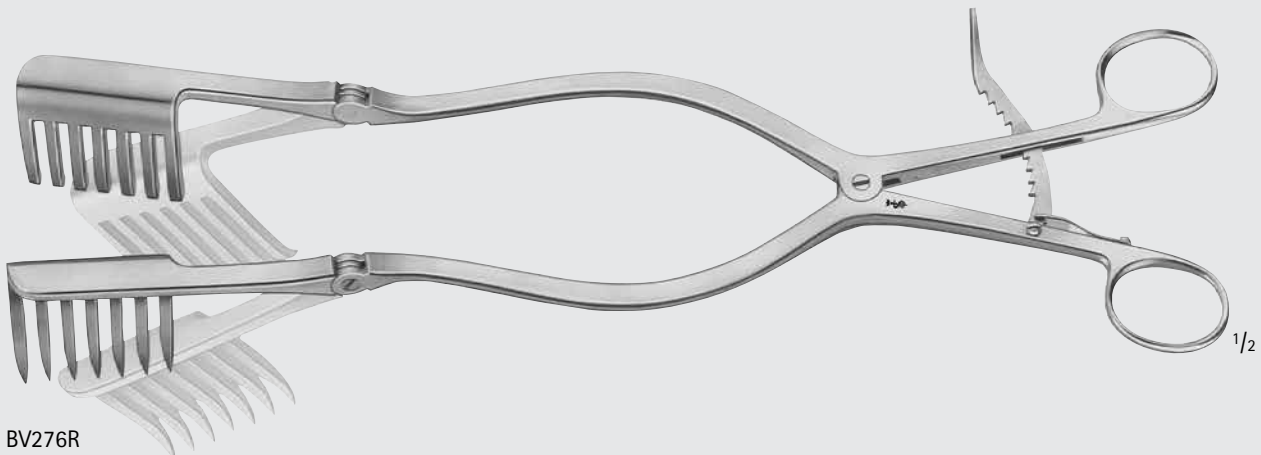

BV276R

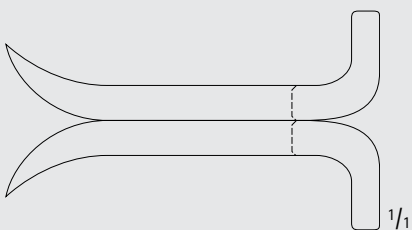

BV276R



ORTHO
SPINE

Orthopedics/Spine

Retractors

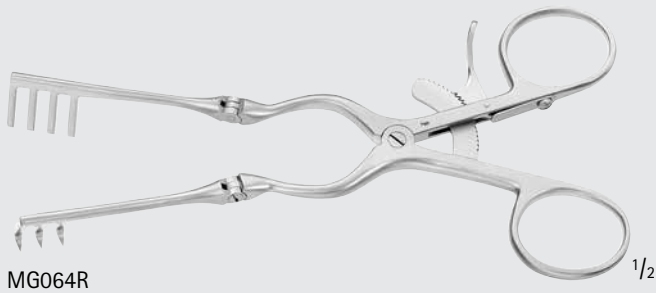

MG064R

1/2

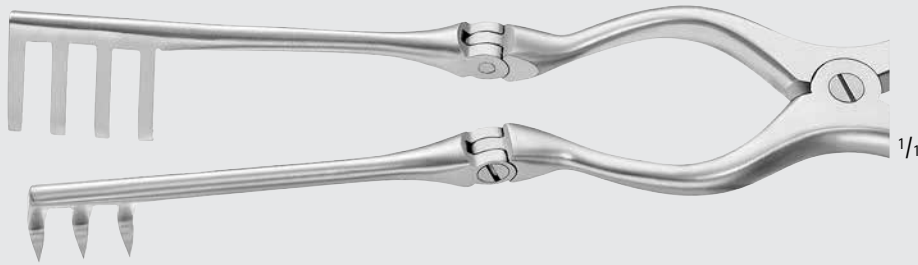

1/1

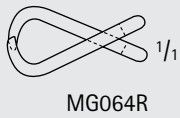

1/1

MG064R



MG371R

1/2



1/1

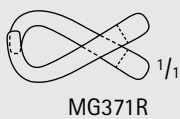

1/1

MG371R

BECKMANN Retractor, Hinged (continued)

Catalog Number	Tip	Blade End	Length (in.)
MG064R	SHARP	3 x 4 PRONGS	6 1/2
MG371R	BLUNT	3 x 4 PRONGS	6 1/4

MISKIMON Cerebellum Retractor

Catalog Number	Tip	Blade End	Length (in.)
MF061R	SEMI-S	7 x 7 PRONGS	7 1/2

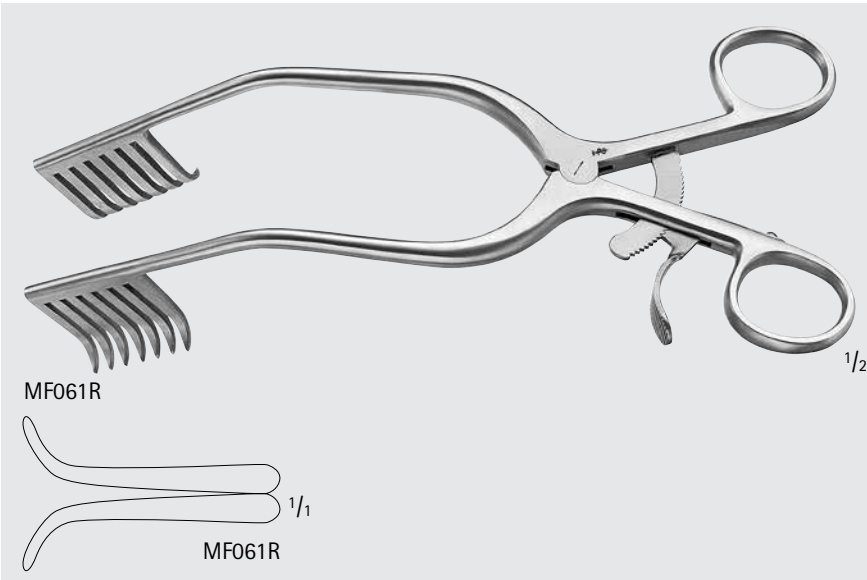

MEYERDING Retractor

Catalog Number	Blade Size (mm)	Length (in.)
MF065R	25 x 57	6 1/2
MF066R	25 x 51	6 1/2
MF067R	25 x 31	6 1/2

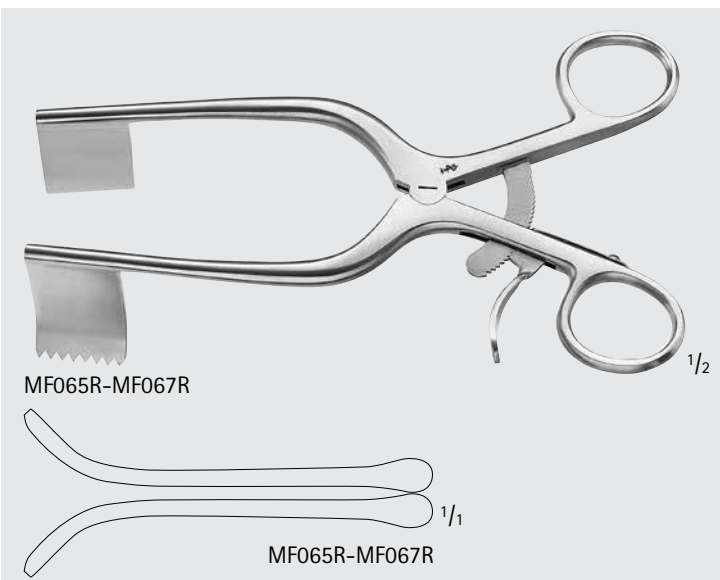

WILLIAMS Retractor

Catalog Number	Tip	Blade Size (mm)	Length (in.)
MF068R	BLADE LEFT	10 x 50	7
MF069R	BLADE RIGHT	10 x 50	7
MF070R	BLADE LEFT	10 x 60	7
MF071R	BLADE RIGHT	10 x 60	7
MF072R	BLADE LEFT	10 x 70	7
MF073R	BLADE RIGHT	10 x 70	7
MF074R	BLADE LEFT	20 x 50	7
MF075R	BLADE RIGHT	20 x 50	7
MF076R	BLADE LEFT	20 x 60	7
MF077R	BLADE RIGHT	20 x 60	7
MF078R	BLADE LEFT	20 x 70	7
MF079R	BLADE RIGHT	20 x 70	7

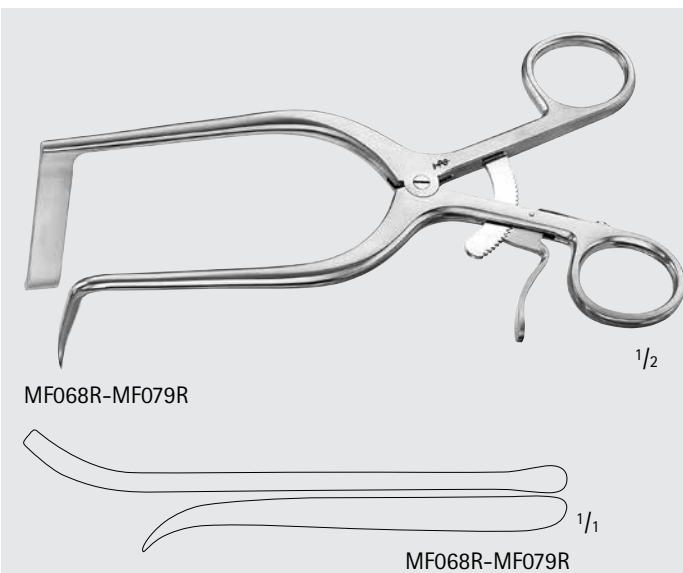

Orthopedics/Spine

Retractors

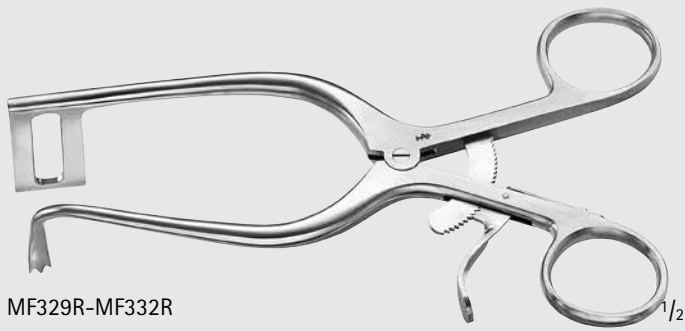

MF329R-MF332R

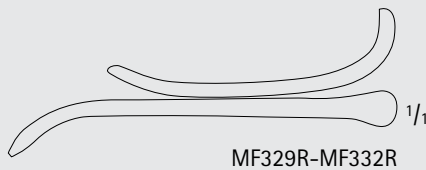

MF329R-MF332R

DUCKER Retractor

Catalog Number	Tip	Blade Size (mm)	Length (in.)
MF329R	HOOK LEFT	50 x 20	6 3/4
MF330R	HOOK RIGHT	50 x 20	6 3/4
MF331R	HOOK LEFT	70 x 20	6 3/4
MF332R	HOOK RIGHT	70 x 20	6 3/4

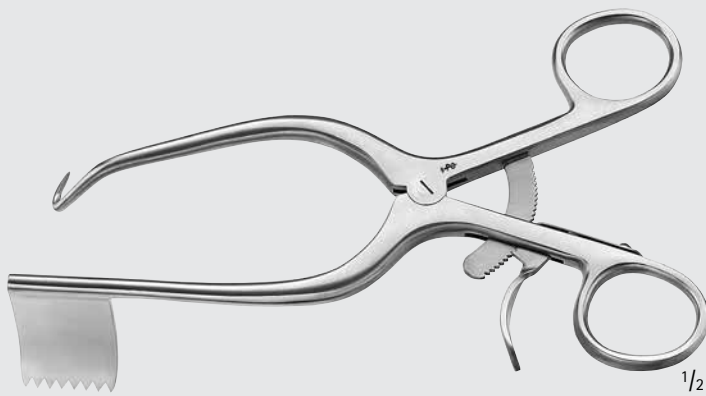

MF442R-MF443R

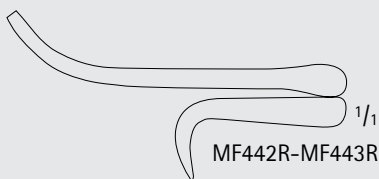

MF442R-MF443R

MARKHAM-MEYERDING Retractor

Catalog Number	Tip	Blade Size (mm)	Length (in.)
MF442R	BLADE RIGHT	46 x 26	7 1/2
MF443R	BLADE LEFT	46 x 26	7 1/2



Zelpi-Type Retractor, Deep Blade

Catalog Number	Tip	Depth (in.)
MD529R	ANG 45°	3
MD527R	ANG 90°	3
MD528R	ANG 90°	4
MD530R	ANG 90°	5

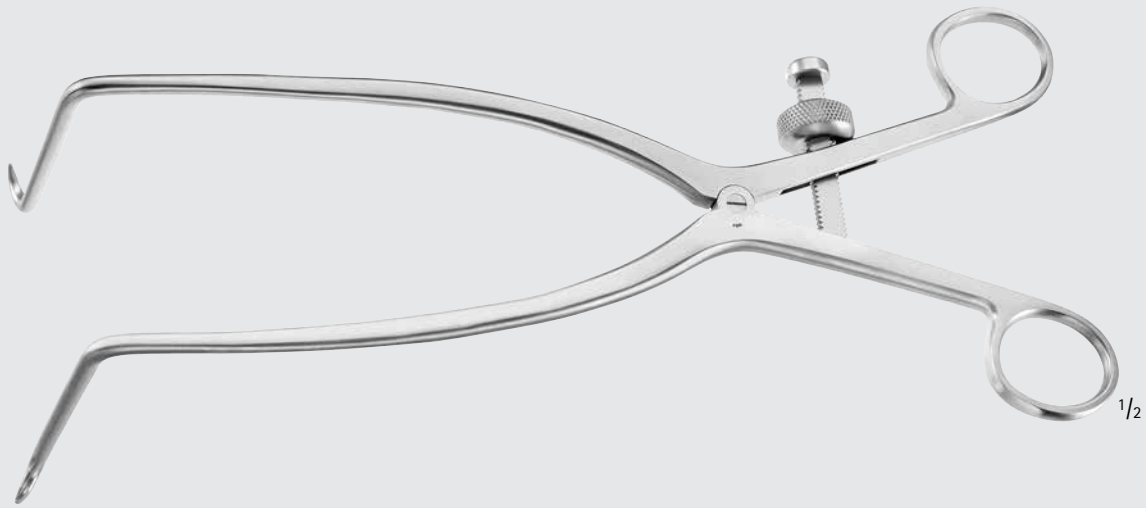

MD529R-MD530R

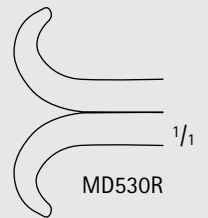
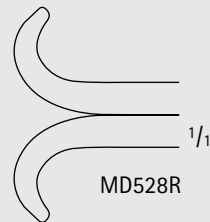
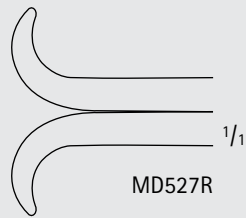
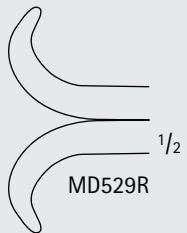

Orthopedics/Spine

Retractors and Spreaders



BV296R

CLOWARD Lamina Spreader

Catalog Number	Tip	Tip Size (mm)	Length (in.)
BV296R	SERR OUTER	5.0	6 1/8



BV299R

CLOWARD Lamina Spreader

Catalog Number	Tip	Tip Size (mm)	Length (in.)
BV299R	SERR	4.5	5 1/4

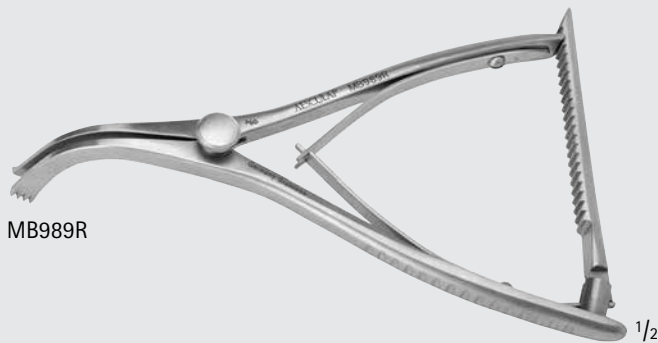

MB989R

INGE Lamina Spreader

Catalog Number	Tip	Length (in.)
MB989R	TOOTHED	6 1/2



INGE Lamina Spreader

Catalog Number	Tip	Tip Size (mm)	Length (in.)
BV297R	SERR	6.0	6 3/4



INGE Lamina Spreader

Catalog Number	Tip	Tip Size (mm)	Length (in.)
BV298R	TOOTHED	12.0	10 3/4

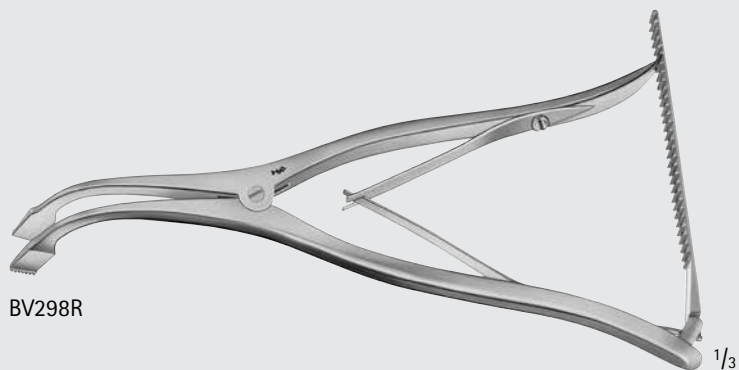

Orthopedics/Spine

Retractors

Aesculap Ball Snap System on Spreaders and Blades

Advantages:

- Blades are safely locked without additional fixation, preventing them from detaching when the instrument is passed to the surgeon. In addition, the smooth surface minimizes the risk of catching a suture.
- Blades can be quickly exchanged during the operation.
- Different retractor patterns can be combined and exchanged at random, which allows for optimum selection of the blade size according to surgical needs.

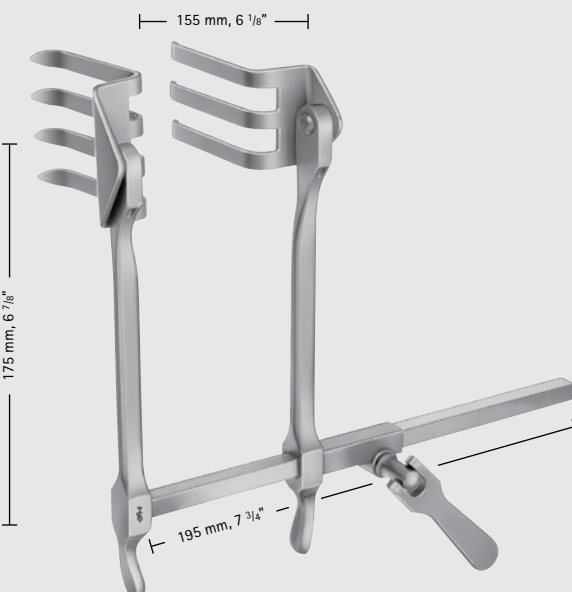

155 mm, 6 1/8"

175 mm, 6 7/8"

195 mm, 7 3/4"

SCOVILLE-RICHTER Laminectomy Retractor, Reversible

Catalog Number	Description
BV510R	COMPLETE

BV510R Includes:
 1 Retractor BV509R and
 1 Pair of blades BV516R
 The retractor bar and shanks rotate 180°

BV510R

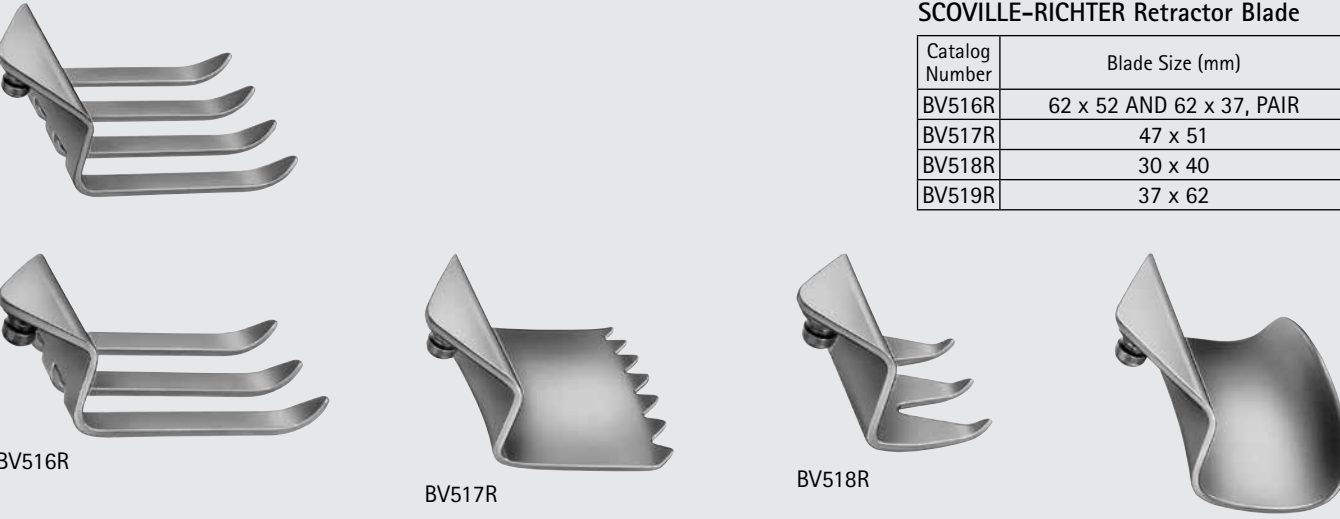

SCOVILLE-RICHTER Retractor Blade

Catalog Number	Blade Size (mm)
BV516R	62 x 52 AND 62 x 37, PAIR
BV517R	47 x 51
BV518R	30 x 40
BV519R	37 x 62

BV516R

BV517R

BV518R

BV519R

- Complete retraction system consisting of a retractor body, various blade configurations, and storage tray. Designed to enable less invasive spine procedures such as discectomies and decompressions.
 - Unique organization system enables easy storage and retrieval of desired blade.
 - Sturdy design provides rigid retraction even at large opening widths.
- All retractor components are titanium. Blade designs improve visualization and intra-operative imaging.

For more information see our brochure number **DOC658**.

MF393 Includes:

- 1 Hinged Titanium Retractor Frame MF365T
- 2 Wide Blades, 40 mm MF368T
- 2 Wide Blades, 50 mm MF369T
- 2 Wide Blades, 60 mm MF370T
- 2 Wide Blades, 70 mm MF371T
- 2 Narrow Blades, 40 mm MF375T
- 2 Narrow Blades, 50 mm MF376T
- 2 Narrow Blades, 60 mm MF377T
- 2 Narrow Blades, 70 mm MF378T
- 1 Storage Tray MF392
- 1 Hook Blade, 30 mm MF381T
- 1 Hook Blade, 40 mm MF382T
- 1 Hook Blade, 50 mm MF383T
- 1 Hook Blade, 60 mm MF384T
- 1 Toothed Blade, 30 mm MF387T
- 1 Toothed Blade, 40 mm MF388T
- 1 Toothed Blade, 50 mm MF389T
- 1 Toothed Blade, 60 mm MF390T

Spine Retractor System

Catalog Number
MF393

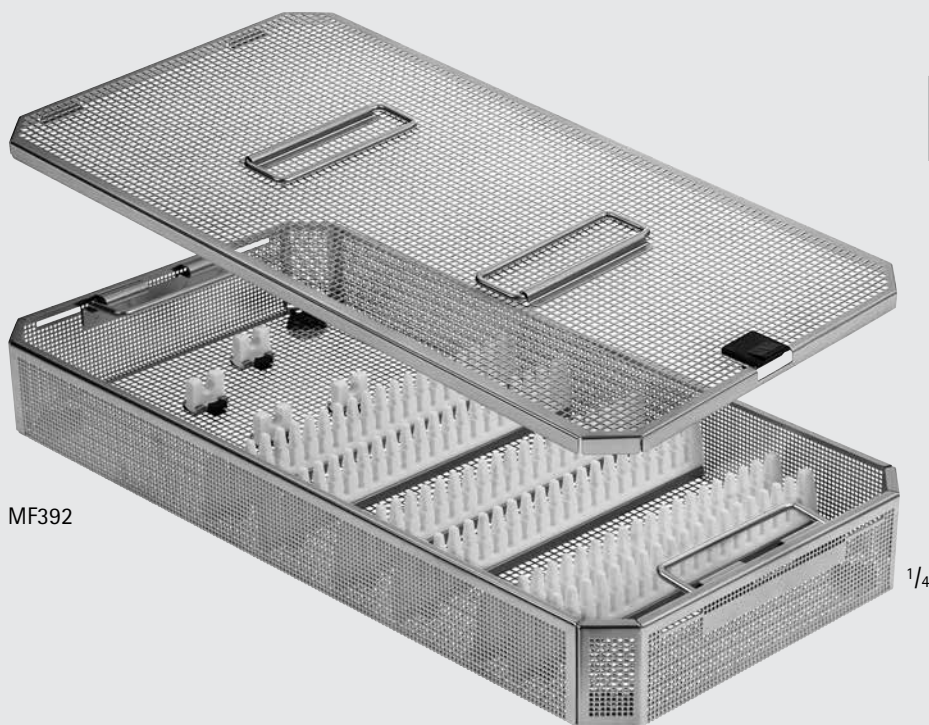

MF392

Storage Tray for Spine Retractor System

Catalog Number
MF392

The storage tray will fit into Aesculap's full size container for sterilization.

For more information about Aesculap's SterilContainter System see our brochure number **DOC132**.



Orthopedics/Spine

Retractors

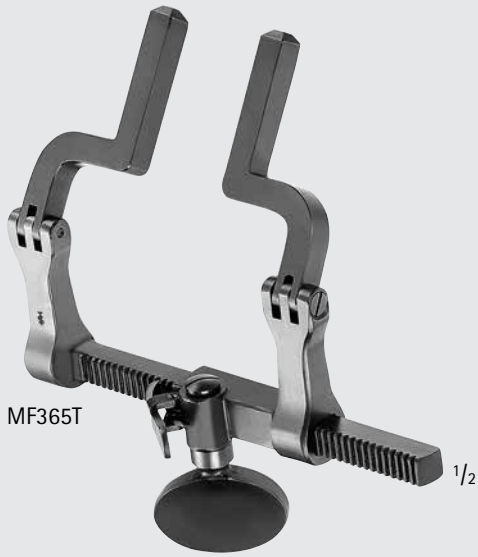

Titanium Retractor Frame, Hinged

Catalog Number
MF365T

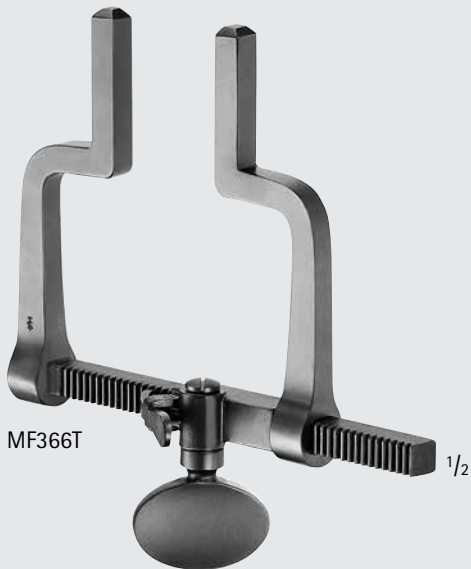

Titanium Retractor Frame, Rigid

Catalog Number
MF366T





MF367T-MF373T

Titanium Retractor Blade, Wide

Catalog Number	Blade Size (mm)
MF367T	27 x 30
MF368T	27 x 40
MF369T	27 x 50
MF370T	27 x 60
MF371T	27 x 70
MF372T	27 x 80
MF373T	27 x 90



MF374T-MF380T

Titanium Retractor Blade, Narrow

Catalog Number	Blade Size (mm)
MF374T	20 x 30
MF375T	20 x 40
MF376T	20 x 50
MF377T	20 x 60
MF378T	20 x 70
MF379T	20 x 80
MF380T	20 x 90

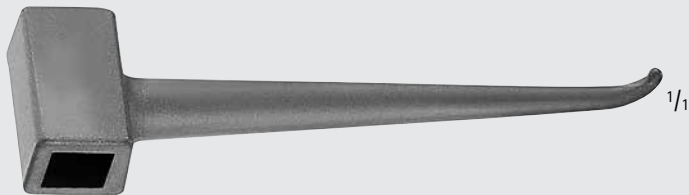

MF381T-MF386T

Titanium Retractor Hook

Catalog Number	Length (mm)
MF381T	30
MF382T	40
MF383T	50
MF384T	60
MF385T	70
MF386T	80



MF387T-MF391T

Titanium Toothed Blades

Catalog Number	Length (mm)
MF387T	30
MF388T	40
MF389T	50
MF390T	60
MF391T	70



ORTHO
SPINE

INCHES

Orthopedics/Spine

Retractors

CHARNLEY Initial Incision Retractor

Catalog Number	Description	Blade	Size	Blade Size (mm)
MB191R	SET COMPLETE	-	-	-
MB156R	INDIVIDUAL BLADE	SMALL	STANDARD DEPTH	25 x 38
MB177R	INDIVIDUAL BLADE	SMALL	MEDIUM DEPTH	25 x 75
MB192R	INDIVIDUAL BLADE	SMALL	LONG DEPTH	25 x 127
MB157R	INDIVIDUAL BLADE	LARGE	STANDARD DEPTH	25 x 44
MB178R	INDIVIDUAL BLADE	LARGE	MEDIUM DEPTH	25 x 75
MB193R	INDIVIDUAL BLADE	LARGE	LONG DEPTH	25 x 127
MG081R	WEIGHT AND CHAIN REPLACEMENT FOR MB191R	-	-	-

MB191R includes:

- 1 frame
- 1 small retractor blade (MB156R)
- 1 large retractor blade (MB157R)
- 1 weight w/ chain (3 lbs.)

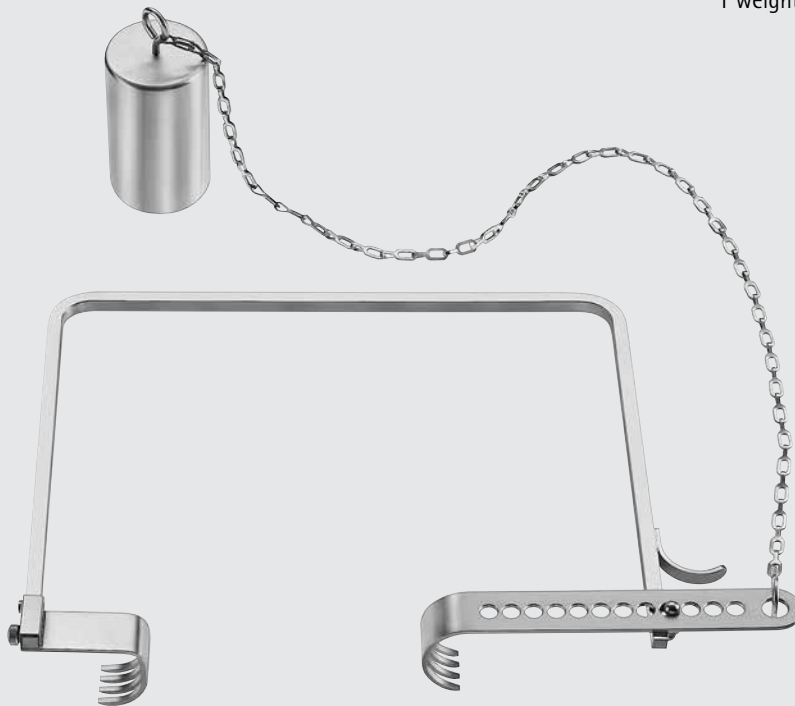

MB191R-MG081R

ORTHO
SPINE

MILLIMETERS



FK507R

Bone File/Rasp

Catalog Number	Tip Size (mm)	Length (in.)
FK507R	20	8 3/4

One Side File Cut
One Side Rasp Cut



FK507R

Bone File

Catalog Number	Tip Size (mm)	Length (in.)
FK511R	13	9 1/2
FK510R	20	11 5/8



FK511R

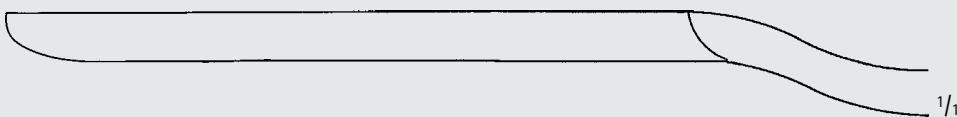

FK511R



FK510R



Orthopedics/Spine

Rasps



OL423R-OL429R

DUROGRIP™ TC FOMON Rasp, Double Ended

Catalog Number	Size	Teeth	Length (in.)
OL423R	3 + 4	16/20	8 1/4
OL425R	5 + 6	24/30	8 1/4
OL427R	7 + 8	36/44	8 1/4
OL429R	9 + 10	52/44	8 1/4



1/1



1/1

OL423R



1/1



1/1

OL425R



1/1



1/1

OL427R

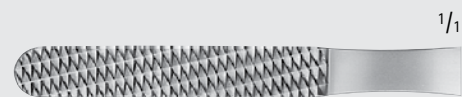

1/1

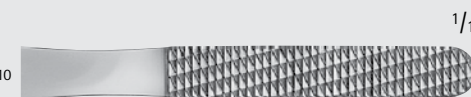

1/1

OL429R

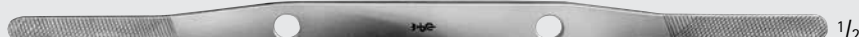

OL405R

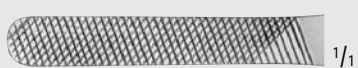

1/1

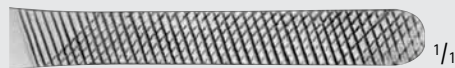

1/1

OL405R



OL406R



1/1



1/1

OL406R



MG584R

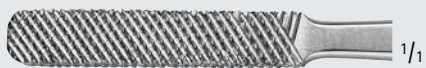

1/1

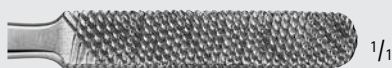

1/1

MG584R



MA418R



1/1



1/1

MA418R

FOMON Bone Rasp, Double Ended

Catalog Number	Tip Size (mm)	Tip	Length (in.)
OL405R	6.5 / 7.5	X-SERR Fine/Coarse	8 1/2
OL406R	6.5 / 7.5	Fine/Coarse	8 1/2
MG584R	8/8	FLAT, CONVEX FINE, COARSE	8 1/2
MA418R	7.5 / 7.5	Coarse/ Xtra-Coarse	8 3/8





OL407R

1/2

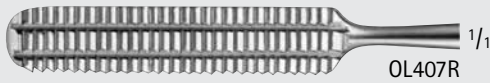

OL407R

1/1



MA419R

1/1



MA420R

1/1

MALTZ Bone Rasp

Catalog Number	Tip Size (mm)	Tip	Length (in.)
OL407R	9	DOWN-STROKE	6 1/2
MA419R	33	DOWN-STROKE	6 1/2
MA420R	33	UP STROKE	6 1/2



OL408R-OL409R

1/2

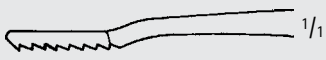

1/1



OL408R

1/1



OL409R

1/1

LEWIS Bone Rasp

Catalog Number	Tip	Tip Size (mm)	Length (in.)
OL408R	FINE-SERR DOWN-STROKE	8	6 7/8
OL409R	COARSE-SERR DOWN-STROKE	8	6 7/8



FK301R-FK302R

1/2

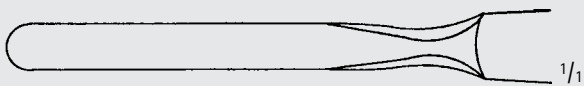

1/1

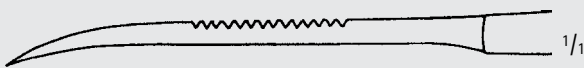

1/1

FK301R

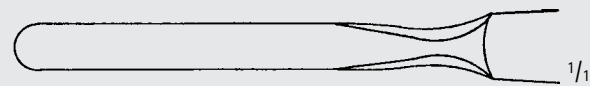

1/1

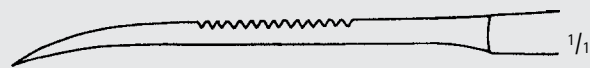

1/1

FK302R

Bone Raspatory

Catalog Number	Blade Size (mm)	Length (in.)
FK301R	6	6 1/2
FK302R	8	6 1/2

PUTTI Bone File, Double Ended

Catalog Number	Tip Size (mm)	Length (in.)
FK505R	18/20	10 5/8



FK505R

1/2

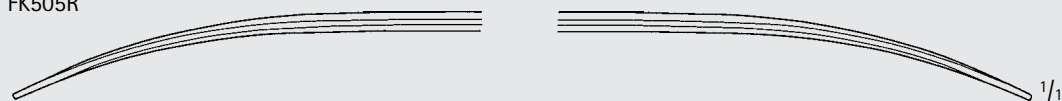

FK505R

1/1



ORTHO SPINE

INCHES

Orthopedics/Spine

Elevators and Bone Levers



MB816R-MB817R

SAYRE Periosteal Elevator

Catalog Number	Tip	Length (in.)
MB816R	SHARP	6 3/4
MB817R	BLUNT	6 3/4

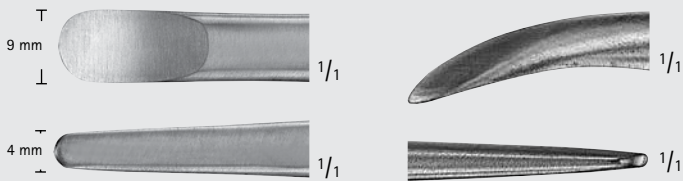

MB816R-MB817R



FK300R

WILLIGER Bone Elevator

Catalog Number	Blade Size (mm)	Length (in.)
FK300R	6	6 1/4

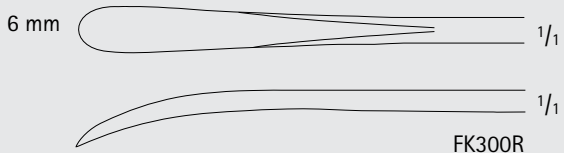

FK300R



FK306R-FK309R

ADSON Elevator

Catalog Number	Tip	Blade Size (mm)	Blade	Length (in.)
FK306R	SHARP	8	STR	6 3/4
FK308R	SEMI-S	7	STR	6 3/4
FK307R	BLUNT	7	CVD	6 3/4
FK309R	SHARP	7	CVD	6 3/4

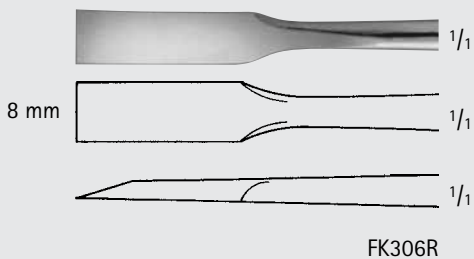

FK306R

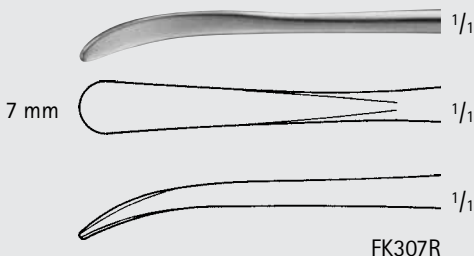

FK307R



FK308R

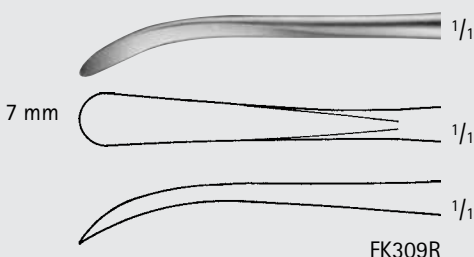

FK309R



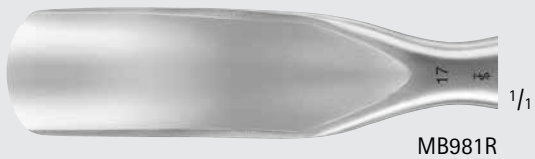
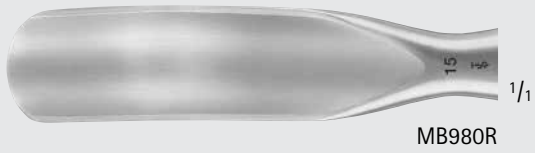

MCGLAMRY Metatarsal Elevators

Catalog Number	Blade Size (mm)	Length (in.)
MB978R	11	6 1/2
MB979R	13	6 1/2
MB980R	15	6 1/2
MB981R	17	6 1/2



Orthopedics/Spine

Elevators and Bone Levers



FK323R

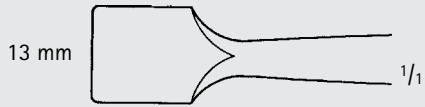

13 mm

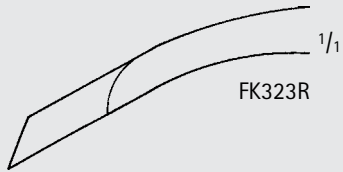

FK323R

Elevator W/ PEEK Handle

Catalog Number	Tip	Blade Size (mm)	Blade	Length (in.)
FK323R	SHARP	13	CVD	6 7/8



FK324R

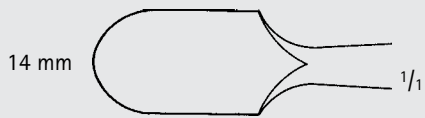

14 mm

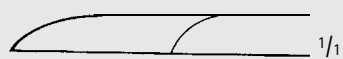

FK324R

Elevator W/ PEEK Handle

Catalog Number	Tip	Blade Size (mm)	Blade	Length (in.)
FK324R	SHARP	14	STR	7 1/2



FK325R

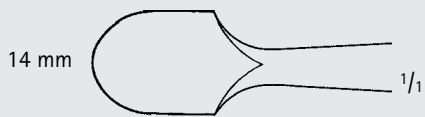

14 mm

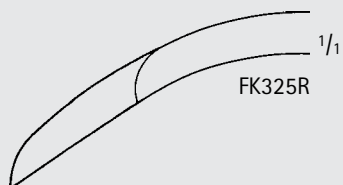

FK325R

Elevator W/ PEEK Handle

Catalog Number	Tip	Blade Size (mm)	Blade	Length (in.)
FK325R	SHARP	14	CVD	7



FK360R

16 mm

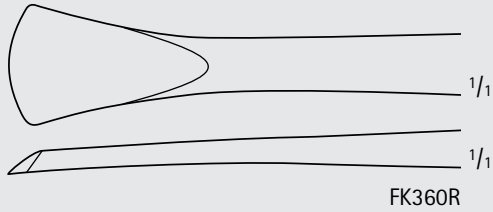

FK360R



MB279R

17 mm

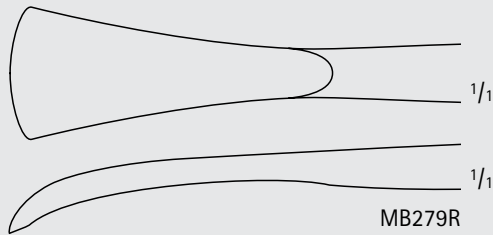

MB279R

LANGENBECK Periosteal Elevator

Catalog Number	Blade Size (mm)	Blade	Length (in.)
FK360R	16	STR	7 1/2
MB279R	17	STR	7 3/4



FK350R

18 mm



FK350R



FK351R

15 mm

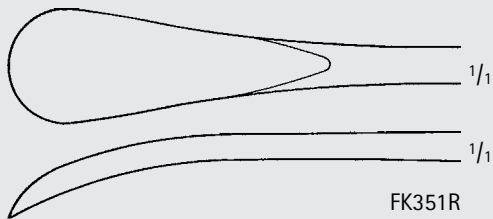

FK351R

SEDILLOT Elevator

Catalog Number	Blade Size (mm)	Blade	Length (in.)
FK350R	18	STR	7 1/4
FK351R	15	CVD	8 1/2



MB536R



MB536R

KEY Periosteal Elevator

Catalog Number	Blade Size (mm)	Length (in.)
MB536R	3.1	6 3/4



Orthopedics/Spine

Elevators and Bone Levers



FK410R-FK414R

KEY Elevator

Catalog Number	Blade Size (mm)	Blade	Length (in.)
FK410R	6.4	STR	7
FK411R	9.5	STR	7 1/2
FK412R	12.7	STR	7 1/2
FK413R	19	STR	7 7/8
FK414R	25.4	STR	8 1/4



MG024R

COBB Elevator, Round

Catalog Number	Blade Size (mm)	Blade	Length (in.)
MG024R	19	CVD	9 1/2

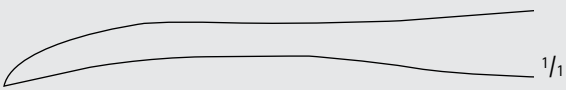
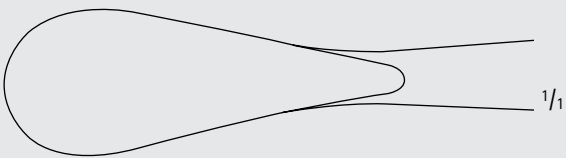

MG024R



COBB Elevator, Sharp

Catalog Number	Blade Size (mm)	Blade	Length (in.)
FK146R	10	CVD	11
FK147R	13	CVD	11
FK148R	19	CVD	11



FK146R-FK148R



10 mm

FK146R



13 mm

FK147R

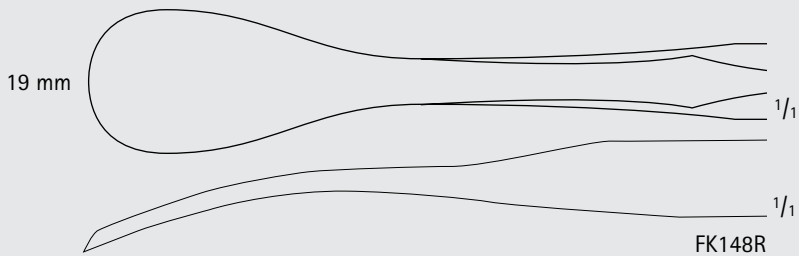

19 mm

FK148R

COBB Periosteal Elevator, Round

Catalog Number	Blade Size (mm)	Blade	Length (in.)
MB518R	7	CVD	12



MB518R



7 mm

MB518R



INCHES

Orthopedics/Spine

Elevators and Bone Levers



COBB Elevator

Catalog Number	Blade Size (mm)	Blade	Length (in.)
MD645	10	ROUND	11
MD646	13	ROUND	11
MD647	19	ROUND	11
MD648	26	ROUND	11
MD649	32	ROUND	11



MD645-MD649

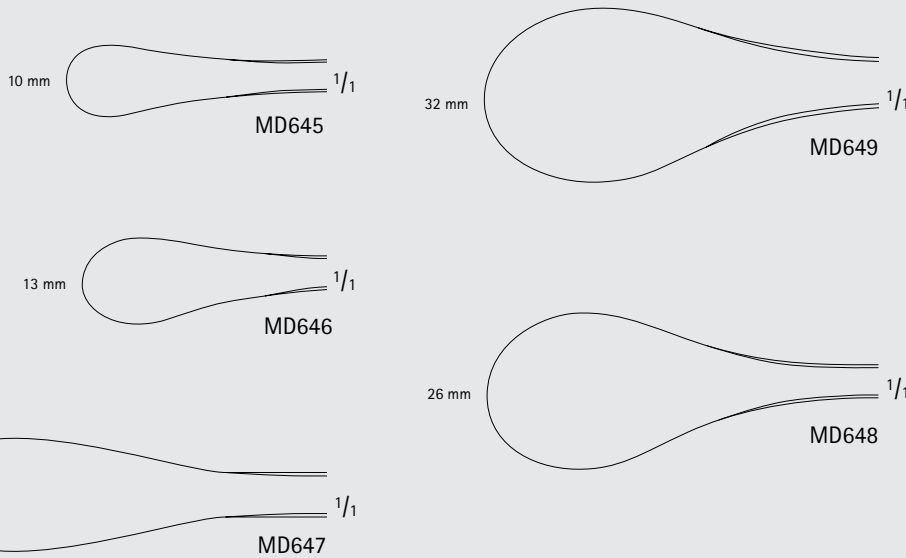

Elevator W/ PEEK Handle

Catalog Number	Blade Size (mm)	Blade	Length (in.)
FK348R	20	CVD	11 1/2



FK348R

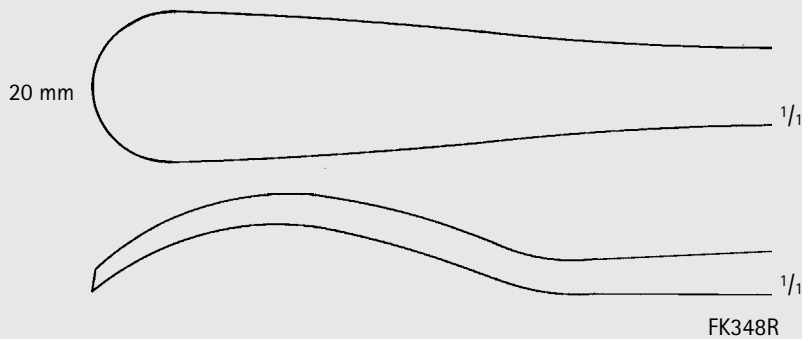

FK348R

WAGNER Elevator W/ PEEK Handle

Catalog Number	Blade Size (mm)	Blade	Length (in.)
FK352R	8	CVD	13
FK353R	17	CVD	13

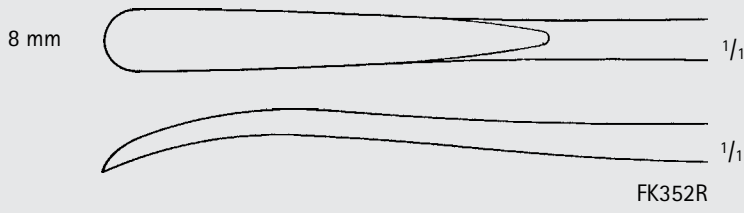

Orthopedics/Spine

Elevators and Bone Levers



MN001R-MN006R

1/3

Black Handled Elevator

Catalog Number	Tip Size (mm)	Handle	Length (in.)
MN001R	10	8 1/2	13 1/4
MN002R	15	8 1/2	13 1/4
MN003R	20	8 1/2	13 1/4
MN004R	25	8 1/2	13 1/4
MN005R	30	8 1/2	13 1/4
MN006R	35	8 1/2	13 1/4
MN007R	9	9	15
MN008R	13	9	15
MN009R	19	9	15
MN010R	25	9	15
MN011R	32	9	15

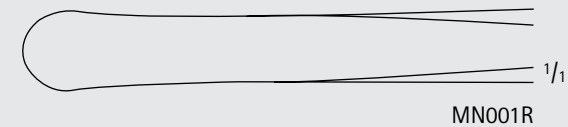

MN001R

1/1

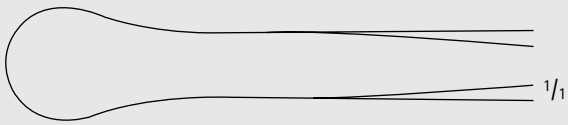

MN002R

1/1

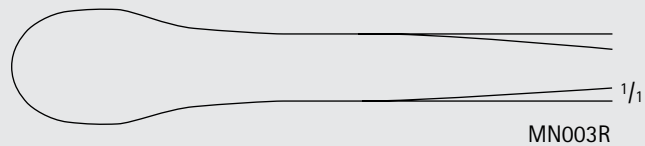

MN003R

1/1

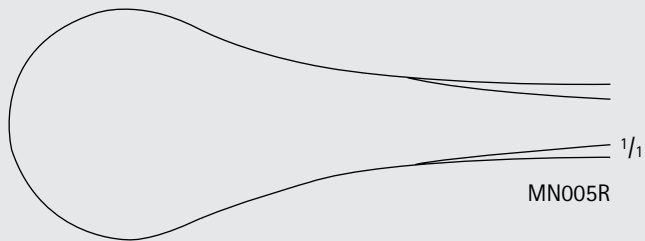

MN005R

1/1

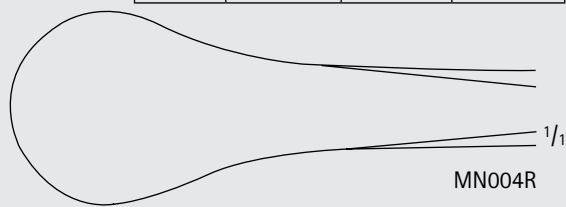

MN004R

1/1

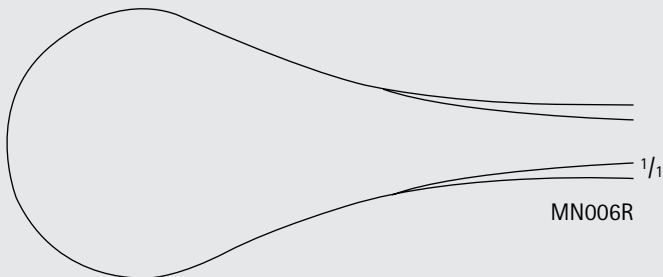

MN006R

1/1



MN007R-MN011R

1/3

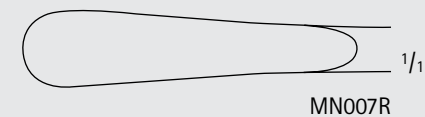

MN007R

1/1

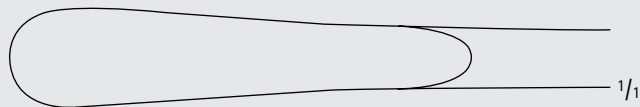

MN008R

1/1

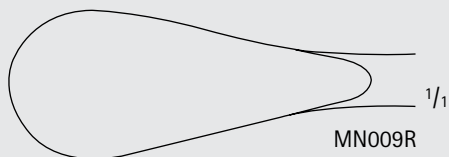

MN009R

1/1

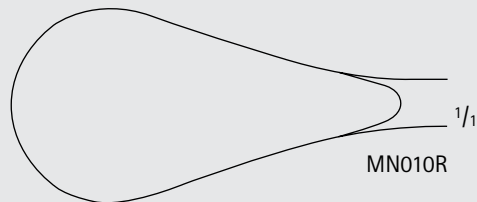

MN010R

1/1

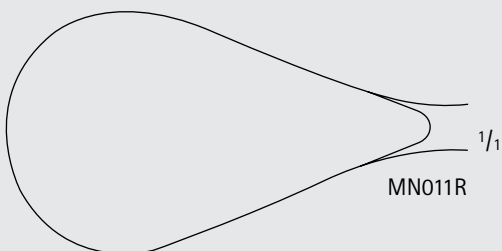

MN011R

1/1



FK120R

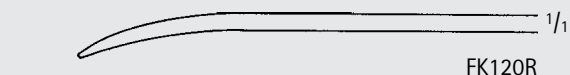
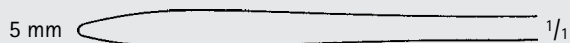

FK120R



FK121R

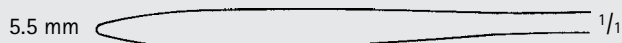

FK121R

WILLIGER Elevator

Catalog Number	Blade Size (mm)	Blade	Length (in.)
FK120R	5	CVD	6 1/2
FK121R	5.5	CVD	6 3/4



FK124R

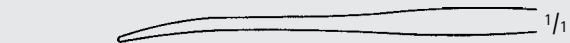

FK124R

SEBILEAU Elevator

Catalog Number	Blade Size (mm)	Blade	Length (in.)
FK124R	5	CVD	6 7/8



ORTHO
SPINE

INCHES

Orthopedics/Spine

Elevators and Bone Levers



FK130R-FK131R

LANGENBECK Elevator

Catalog Number	Blade Size (mm)	Blade	Length (in.)
FK130R	8	CVD	7 3/4
FK131R	10	CVD	7 3/4
FK139R	11	CVD	9

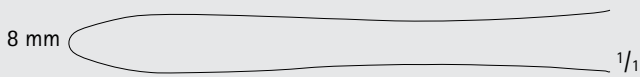

8 mm

1/1

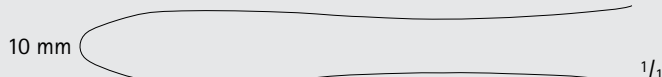

10 mm

1/1

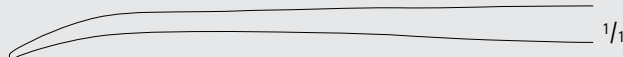

1/1

FK130R

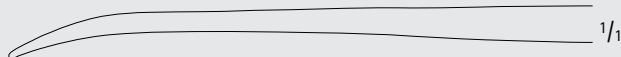

1/1

FK131R



FK139R

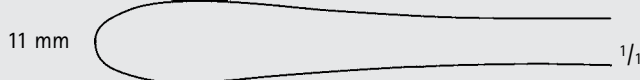

11 mm

1/1

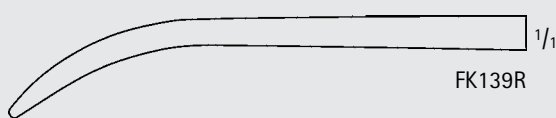

1/1

FK139R



FK133R

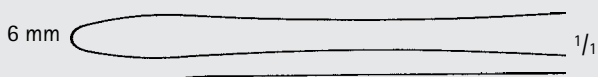

6 mm

1/1

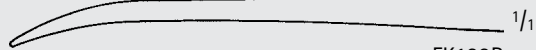

1/1

FK133R

QUERVAIN Elevator, Joker

Catalog Number	Blade Size (mm)	Blade	Length (in.)
FK133R	6	CVD	7 3/4



FK135R

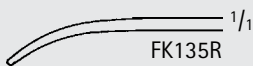

FK135R

1/1

LANE TRETHOWAN Bone Lever

Catalog Number	Blade	Length (in.)
FK135R	CVD	8 1/2



FK136R

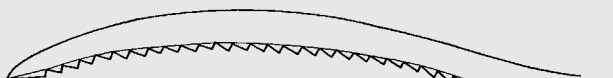

1/1

FK136R

LANE Bone Lever

Catalog Number	Blade	Length (in.)
FK136R	CVD	10



MB818R-MB820R



6.5 mm

1/1



MB818R



7.1 mm

1/1



MB819R



14.6 mm

1/1



MB820R

CREGO Elevator

Catalog Number	Tip	Blade Size (mm)	Blade	Length (in.)
MB818R	BLUNT	6.5	CVD	8
MB819R	BLUNT	7.1	CVD	8
MB820R	BLUNT	14.6	CVD	8

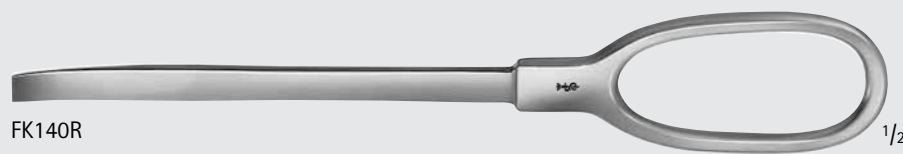

FK140R

1/2

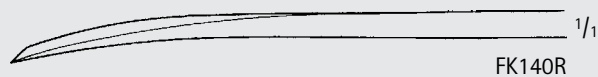

FK140R

BRISTOW Bone Lever

Catalog Number	Length (in.)
FK140R	5 374



ORTHO
SPINE

Orthopedics/Spine

Elevators and Bone Levers

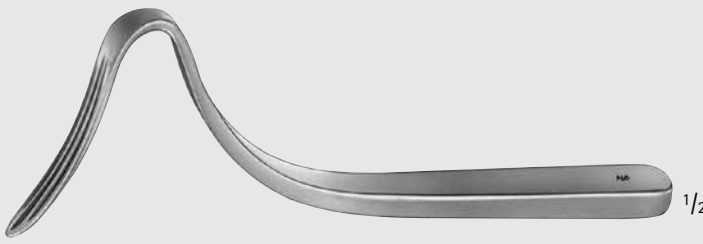

FK158R

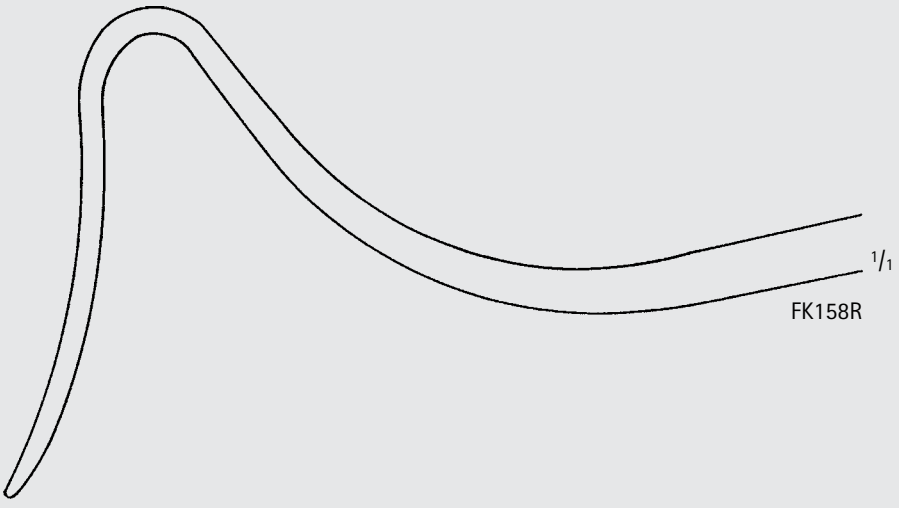

FK158R

TAEGER Bone Lever F/ Angle Joint Operations

Catalog Number	Blade Size (mm)	Blade	Length (in.)
FK158R	12	CVD	6 7/8

CHANDLER Bone Elevator

Catalog Number	Blade Size (mm)	Blade	Length (in.)
MB275R	14	SMALL	7 1/4
MB276R	19	MEDIUM	8
MB277R	25	LARGE	9 1/4
MB278R	30	EXTRA LARGE	10



MB275R-MB278R

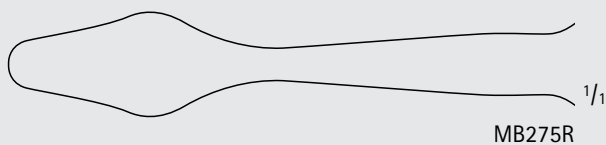

MB275R

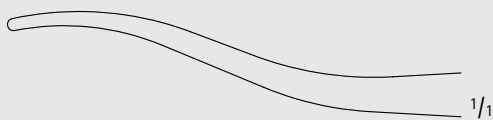

MB276R

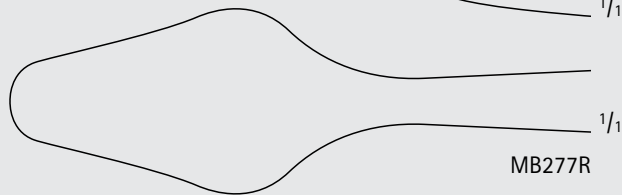

MB277R

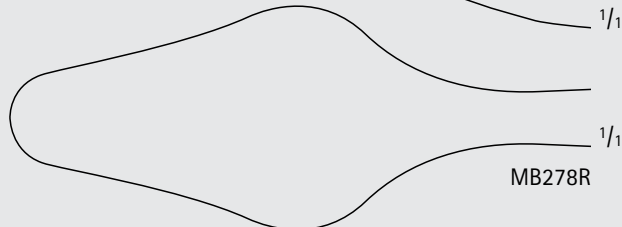
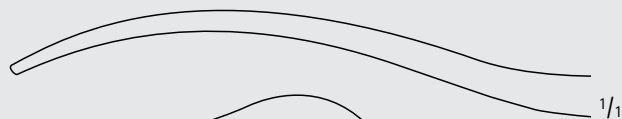

MB278R



Orthopedics/Spine

Chisels, Gouges and Osteotomes



MB850R-MB855R, MB991R

1/2



MB856R-MB859R, MB992R-MB996R

1/2

HIBBS Chisel

Catalog Number	Tip Size (mm)	Blade	Length (in.)
MB850R	7	STR	9 1/2
MB991R	10	STR	9 1/2
MB851R	15	STR	9 1/2
MB852R	19	STR	9 1/2
MB853R	22	STR	9 1/2
MB854R	25	STR	9 1/2
MB855R	38	STR	9 1/2
MB856R	7	CVD	9 1/2
MB857R	9	CVD	9 1/2
MB992R	13	CVD	9 1/2
MB858R	15	CVD	9 1/2
MB859R	19	CVD	9 1/2
MB993R	22	CVD	9 1/2
MB994R	25	CVD	9 1/2
MB995R	32	CVD	9 1/2
MB996R	38	CVD	9 1/2



FL503R-FL507R

1/2

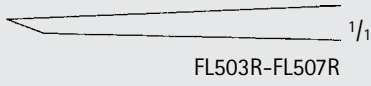

FL503R-FL507R

1/1

STILLE Chisel

Catalog Number	Tip Size (mm)	Length (in.)
FL503R	10	8
FL504R	12	8
FL505R	15	8
FL506R	20	8
FL507R	25	8

Chisel Handle F/ Interchangeable Blades

Catalog Number	Item
FL665R	HANDLE W/KEY
GB020R	REPLACEMENT KEY



FL665R

1/2

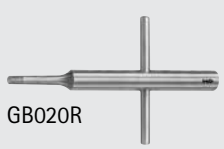

GB020R

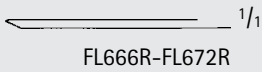

Chisel Blade, F/FL665R

Catalog Number	Tip Size (mm)	Tip Size (in.)	Working Length (mm)
FL666R	5	3/16	45
FL668R	10	3/8	45
FL670R	16	5/8	45
FL672R	25	1	45



FL682R

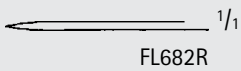

Osteotome Blade, F/FL665R

Catalog Number	Tip Size (mm)	Tip Size (in.)	Working Length (mm)
FL682R	25	1	78



FL685R-FL687R

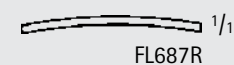
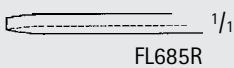
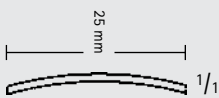

Concave Chisel Blade, F/FL665R

Catalog Number	Radius (mm)	Tip Size (mm)	Tip Size (in.)
FL685R	50	25	1
FL687R	70	25	1



ORTHO
SPINE

INCHES

Orthopedics/Spine

Chisels, Gouges and Osteotomes



Lamina Gouge W/ HARTPRESS Handle

Catalog Number	Tip Size (mm)	Tip Size (in.)	Length (in.)
FL437R	6	1/4	9 1/4
FL438R	8	5/16	9 1/4
FL439R	11	7/16	9 1/4
FL440R	16	5/8	9 1/4

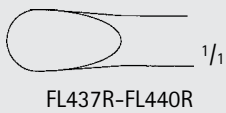

Chisel W/ PEEK Handle

Catalog Number	Tip Size (mm)	Tip Size (in.)	Length (in.)
FL430R	20	3/4	9 5/8

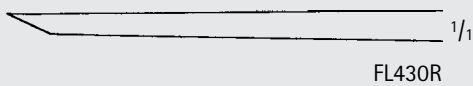

LEXER-MINI Gouge W/ PEEK Handle

Catalog Number	Tip Size (mm)	Tip Size (in.)	Length (in.)
FL390R	4	5/32	7
FL391R	6	1/4	7
FL392R	8	5/16	7
FL393R	10	3/8	7
FL394R	12	1/2	7

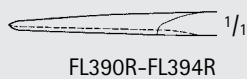



FL411R-FL418R

1/2

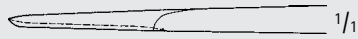

FL411R-FL418R

1/1

LEXER Gouge W/ PEEK Handle

Catalog Number	Tip Size (mm)	Tip Size (in.)	Length (in.)
FL411R	5	3/16	8 7/8
FL412R	7	9/32	8 7/8
FL413R	10	3/8	8 7/8
FL415R	15	5/8	8 7/8
FL416R	20	3/4	8 7/8
FL417R	25	1	8 7/8
FL418R	30	1 3/16	8 7/8



FL420R

1/2

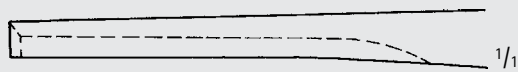

FL420R

1/1

Gouge, F/ Removing Broken Screws, W/ PEEK Handle

Catalog Number	Tip Size (mm)	Tip Size (in.)	Length (in.)
FL420R	9	3/8	8 7/8



FL423R

1/2

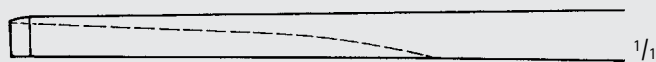

1/1



1/1



1/1

FL423R

LEXER Spongiosa Gouge W/ PEEK Handle

Catalog Number	Tip Size (mm)	Tip Size (in.)	Length (in.)
FL423R	10	3/8	11



ORTHO
SPINE

INCHES

Orthopedics/Spine

Chisels, Gouges and Osteotomes



FL701R-FL702R

ZIELKE Gouge W/ PEEK Handle

Catalog Number	Tip Size (mm)	Tip Size (in.)	Length (in.)
FL701R	5.5	7/32	9
FL702R	9	3/8	9

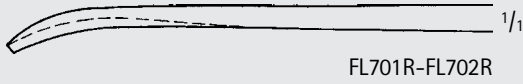

FL701R-FL702R



FL441R-FL445R

Spongiosa Gouge W/ PEEK Handle

Catalog Number	Tip Size (mm)	Tip Size (in.)	Blade	Length (in.)
FL441R	5	3/16	CVD	9 3/4
FL443R	10	3/8	CVD	9 3/4
FL445R	15	5/8	CVD	9 3/4

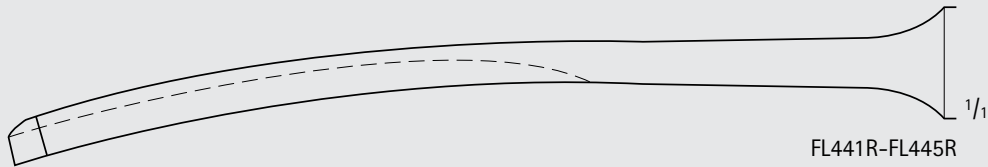

FL441R-FL445R



FL573R-FL577R

STILLE Gouge

Catalog Number	Tip Size (mm)	Tip Size (in.)	Length (in.)
FL573R	10	3/8	8
FL574R	12	1/2	8
FL575R	15	5/8	8
FL576R	20	3/4	8
FL577R	25	1	8

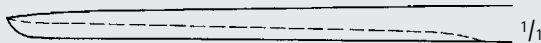

FL573R-FL577R



WAGNER Gouge W/ PEEK Handle

Catalog Number	Tip Size (mm)	Tip Size (in.)	Blade Shape	Length (in.)
ND120R	9	3/8	ANG FWD	13 3/8
ND121R	9	3/8	ANG BACK	13 3/8
ND122R	15	5/8	ANG FWD	13 3/8
ND123R	15	5/8	ANG BACK	13 3/8
ND124R	9	3/8	STR	13 3/8
ND125R	15	5/8	STR	13 3/8



ND120R-ND125R

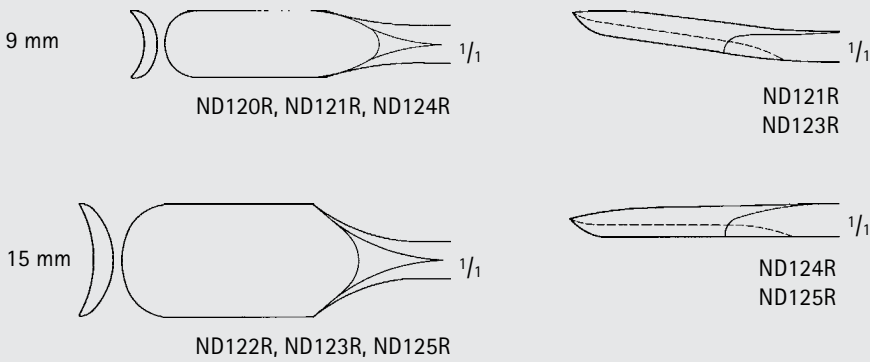

SMITH-PETERSON Gouge

Catalog Number	Tip	Tip Size (mm)	Length (in.)
MF465R	STR	6	8
MF466R	STR	10	8
MF467R	STR	13	8
MF468R	STR	16	8
MF469R	STR	19	8
MF470R	STR	25	8
MF471R	STR	32	8
MF472R	CVD	6	8
MF473R	CVD	10	8
MF474R	CVD	13	8
MF475R	CVD	16	8
MF476R	CVD	19	8
MF477R	CVD	25	8
MF478R	CVD	32	8



MF465R-MF478R



Orthopedics/Spine

Chisels, Gouges and Osteotomes



FL380R-FL384R

1/2

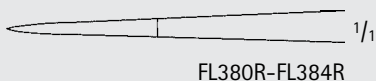

FL380R-FL384R

1/1

LEXER-MINI Osteotome W/ PEEK Handle

Catalog Number	Tip Size (mm)	Tip Size (in.)	Length (in.)
FL380R	4	5/32	7
FL381R	6	1/4	7
FL382R	8	5/16	7
FL383R	10	3/8	7
FL384R	12	1/2	7



FL401R-FL408R

1/2



FL401R-FL408R

1/1

LEXER Osteotome W/ PEEK Handle

Catalog Number	Tip Size (mm)	Tip Size (in.)	Length (in.)
FL401R	5	3/16	8 7/8
FL402R	7	9/32	8 7/8
FL403R	10	3/8	8 7/8
FL405R	15	5/8	8 7/8
FL406R	20	3/4	8 7/8
FL407R	25	1	8 7/8
FL408R	30	1 3/16	8 7/8
ND108R	10	3/8	10 3/4
ND109R	15	5/8	10 3/4



ND108R-ND109R

1/2

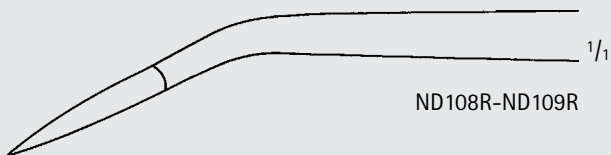

ND108R-ND109R

1/1

Chisel W/ PEEK Handle

Catalog Number	Tip Size (mm)	Tip Size (in.)	Length (in.)
ND105R	16	5/8	10 1/2



ND105R

1/2

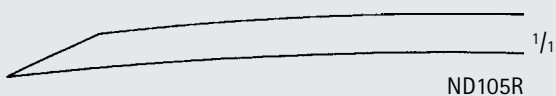

ND105R

1/1



COBB Gouge

Catalog Number	Blade	Length (in.)
MB707R	STR	11 1/2



Gouge, Double Curved, W/ HARTPRESS Handle

Catalog Number	Tip Size (mm)	Tip Size (in.)	Length (in.)
ND118R	25	1	11 1/4



ND118R

HIBBS Gouge

Catalog Number	Tip Size (mm)	Tip Size (in.)	Blade	Length (in.)
MB709R	16	5/8	STR	9 1/2
MB710R	19	3/4	STR	9 1/2
MB711R	22	7/8	STR	9 1/2
MB712R	25	1	STR	9 1/2
MB713R	28	1 1/8	STR	9 1/2
MB714R	32	1 1/4	STR	9 1/2
MB715R	38	1 1/2	STR	9 1/2
MB716R	6	1/4	CVD	9 1/2
MB717R	9	3/8	CVD	9 1/2
MB718R	13	1/2	CVD	9 1/2
MB719R	13	5/8	CVD	9 1/2
MB720R	19	3/4	CVD	9 1/2
MB721R	25	1	CVD	9 1/2
MB722R	28	1 1/8	CVD	9 1/2
MB723R	38	1 1/2	CVD	9 1/2



ORTHO
SPINE

INCHES

Orthopedics/Spine

Chisels, Gouges and Osteotomes



FL156R-FL170R

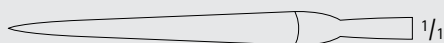

FL156R-FL160R

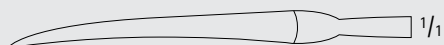

FL166R-FL170R

HOKE Osteotome

Catalog Number	Tip Size (mm)	Tip Size (in.)	Blade	Length (in.)
FL156R	3	1/8	STR	6 1/8
FL157R	6	1/4	STR	6 1/8
FL158R	10	3/8	STR	6 1/8
FL159R	13	1/2	STR	6 1/8
FL160R	16	5/8	STR	6 1/8
FL166R	3	1/8	CVD	6 1/8
FL167R	6	1/4	CVD	6 1/8
FL168R	10	3/8	CVD	6 1/8
FL169R	13	1/2	CVD	6 1/8
FL170R	16	5/8	CVD	6 1/8



FL512R-FL517R

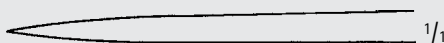

FL512R-FL517R



FL523R-FL527R



FL523R-FL527R



FL553R-FL557R



FL553R-FL557R

STILLE Osteotome

Catalog Number	Tip Size (mm)	Tip Size (in.)	Blade	Length (in.)
FL512R	8	5/16	STR, HVY	8
FL513R	10	3/8	STR, HVY	8
FL514R	12	1/2	STR, HVY	8
FL515R	15	5/8	STR, HVY	8
FL516R	20	3/4	STR, HVY	8
FL517R	25	1	STR, HVY	8
FL523R	10	3/8	STR	8
FL524R	12	1/2	STR	8
FL525R	15	5/8	STR	8
FL526R	20	3/4	STR	8
FL527R	25	1	STR	8
FL553R	10	3/8	CVD	8
FL554R	12	1/2	CVD	8
FL555R	15	5/8	CVD	8
FL556R	20	3/4	CVD	8
FL557R	25	1	CVD	8



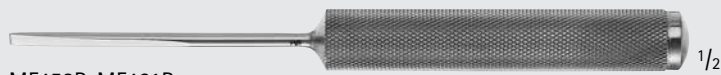

MF458R-MF461R

1/2

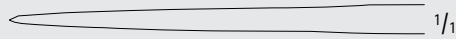

1/1

MF458R-MF461R

Gouge

Catalog Number	Tip Size (mm)	Tip	Length (in.)
MF458R	4	CVD	7
MF459R	4	STR	7
MF460R	6	CVD	7 1/2
MF461R	6	STR	7 1/2



MB657R-MB669R

1/2



1/2

MB657R-MB662R

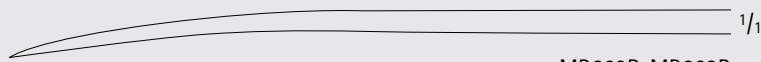

1/1

MB663R-MB669R

SMITH-PETERSON Osteotome

Catalog Number	Tip Size (mm)	Tip Size (in.)	Blade	Length (in.)
MB657R	7	9/32	STR	8
MB658R	11	7/16	STR	8
MB659R	14	9/16	STR	8
MB660R	17	21/32	STR	8
MB661R	19	3/4	STR	8
MB662R	25	1	STR	8
MB663R	6	1/4	CVD	8
MB664R	9.5	3/8	CVD	8
MB665R	13	1/2	CVD	8
MB666R	16	5/8	CVD	8
MB667R	19	3/4	CVD	8
MB668R	25	1	CVD	8
MB669R	32	1 1/4	CVD	8



MB675R-MB684R

1/2

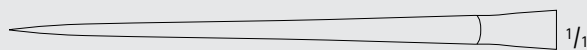

1/1

MB675R-MB684R



MB685R-MB694R

1/2

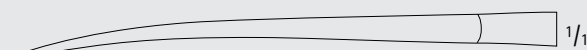

1/1

MB685R-MB694R

HIBBS Osteotome

Catalog Number	Tip Size (mm)	Tip Size (in.)	Blade	Length (in.)
MB675R	6	1/4	STR	9 5/8
MB676R	10	3/8	STR	9 5/8
MB677R	13	1/2	STR	9 5/8
MB678R	16	5/8	STR	9 5/8
MB679R	19	3/4	STR	9 5/8
MB680R	22	7/8	STR	9 5/8
MB681R	25	1	STR	9 5/8
MB682R	28	1 1/8	STR	9 5/8
MB683R	32	1 1/4	STR	9 5/8
MB684R	38	1 1/2	STR	9 5/8
MB685R	6	1/4	CVD	9 5/8
MB686R	10	3/8	CVD	9 5/8
MB687R	13	1/2	CVD	9 5/8
MB688R	16	5/8	CVD	9 5/8
MB689R	19	3/4	CVD	9 5/8
MB690R	22	7/8	CVD	9 5/8
MB691R	25	1	CVD	9 5/8
MB692R	28	1 1/8	CVD	9 5/8
MB693R	32	1 1/4	CVD	9 5/8
MB694R	38	1 1/2	CVD	9 5/8



ORTHO
SPINE

INCHES

Orthopedics/Spine

Chisels, Gouges and Osteotomes

COBB Osteotomes

Catalog Number	Tip Size (mm)	Blade	Length (in.)
MB084R	6	STR	11
MB085R	10	STR	11
MB742R	13	STR	11
MB087R	13	STR	11
MB088R	16	STR	11
MB089R	19	STR	11
MB090R	25	STR	11
MG030R	6	CVD	11
MG031R	10	CVD	11
MG032R	13	CVD	11
MG033R	16	CVD	11
MG036R	19	CVD	11
MG034R	25	CVD	11
MG035R	32	CVD	11

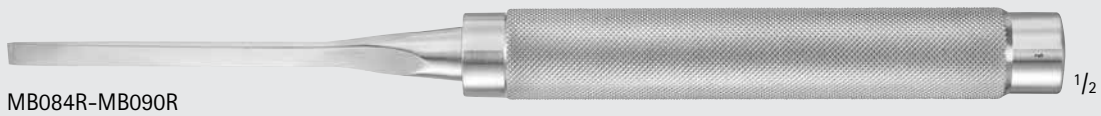

MB084R-MB090R

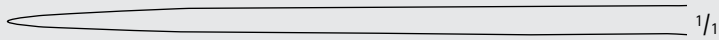

MB084R-MB090R



MG030R-MG035R

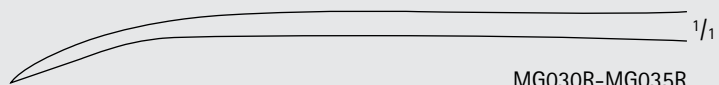

MG030R-MG035R



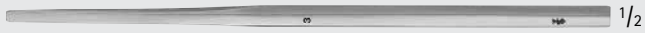

MB404R-MB373R



MB404R-MB373R

Osteotome W/ Hexagonal Handle

Catalog Number	Tip Size (mm)	Length (in.)
MB404R	2	6 1/4
MB405R	3	6 1/4
MB406R	4	6 1/4
MB407R	5	6 1/4
MB408R	6	6 1/4
MB409R	7	6 1/4
MB410R	8	6 1/4
MB411R	9	6 1/4
MB412R	10	6 1/4
MB413R	11	6 1/4
MB373R	12	6 1/4

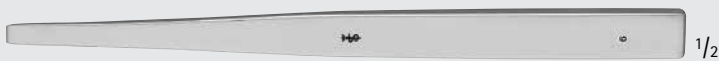

MB398R-MB403R



MB398R-MB403R

CONVERSE Osteotome

Catalog Number	Tip Size (mm)	Length (in.)
MB398R	2	7
MB399R	4	7
MB400R	6	7
MB401R	8	7
MB402R	10	7
MB403R	12	7



MB388R-MB389R

RUBIN Osteotome, W/ Finger Grip

Catalog Number	Tip Size (mm)	Length (in.)
MB388R	10	6 1/2
MB389R	14	6 1/2



ORTHO
SPINE

Orthopedics/Spine

Chisels, Gouges and Osteotomes



FL088R-MG049R

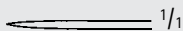

FL088R-MG049R

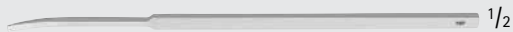

MG037R-MG044R

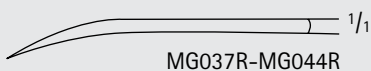

MG037R-MG044R

LAMBOTTE Osteotome

Catalog Number	Tip Size (mm)	Blade	Length (in.)
MG050R	SET OF 7	STR	-
FL088R	2	STR	5
FL101R	4	STR	5
FL102R	6	STR	5
FL104R	8	STR	5
FL106R	10	STR	5
FL108R	12	STR	5
MG046R	14	STR	5
FL109R	15	STR	5
MG047R	18	STR	5
MG048R	19	STR	5
MG049R	20	STR	5
MG037R	2	CVD	5
MG038R	4	CVD	5
MG039R	6	CVD	5
MG040R	8	CVD	5
MG041R	10	CVD	5
MG042R	12	CVD	5
MG043R	14	CVD	5
MG044R	15	CVD	5

LAMBOTTE MINI OSTEOTOME SET:
CONTAINS SEVEN MG050R STRAIGHT 5"
OSTEOTOMES:
2MM, 4MM, 6MM, 8MM, 10MM, 12MM,
14MM PLUS MALLET (FLO36R)



MB621R-MB628R

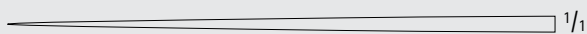

MB620R-MB628R

LAMBOTTE Osteotome with Calibrations

Catalog Number	Tip Size (mm)	Blade	Length (in.)
MB620R	COMPLETE SET	-	-
MB621R	4	STR	7 1/4
MB622R	6	STR	7 1/4
MB623R	7	STR	7 1/4
MB624R	8	STR	7 1/4
MB625R	10	STR	7 1/4
MB626R	12	STR	7 1/4
MB627R	16	STR	7 1/4
MB628R	22	STR	7 1/4

MB620R includes:
Osteotome MB621R-MB628R and
Mallet MB629R





MB640R-MB646R

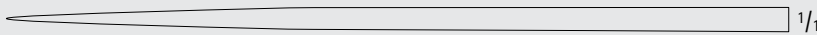

MB640R-MB646R



MB650R-MB656R

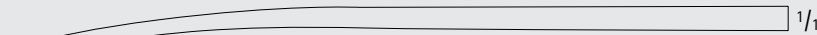

MB650R-MB656R

LAMBOTTE Osteotome

Catalog Number	Tip Size (mm)	Tip Size (in.)	Blade	Length (in.)
MB640R	COMPLETE SET		STR	
MB641R	6	1/4	STR	9
MB642R	13	1/2	STR	9
MB643R	19	3/4	STR	9
MB644R	25	1	STR	9
MB645R	32	1 1/4	STR	9
MB646R	38	1 1/2	STR	9
MB650R	COMPLETE SET		CVD	
MB651R	6	1/4	CVD	9
MB652R	13	1/2	CVD	9
MB653R	19	3/4	CVD	9
MB654R	25	1	CVD	9
MB655R	32	1 1/4	CVD	9
MB656R	38	1 1/2	CVD	9

LAMBOTTE Osteotome

Catalog Number	Tip Size (mm)	Blade	Length (in.)
FL650R	4	STR	9 5/8
FL651R	8	STR	9 5/8
FL652R	10	STR	9 5/8
FL653R	13	STR	9 5/8
FL654R	15	STR	9 5/8
FL655R	18	STR	9 5/8
FL656R	20	STR	9 5/8
FL658R	25	STR	9 5/8
FL659R	30	STR	9 5/8
FL660R	38	STR	9 5/8
FL661R	44	STR	9 5/8
FL662R	50	STR	9 5/8
FL781R	8	CVD	9 5/8
FL783R	13	CVD	9 5/8
FL785R	18	CVD	9 5/8
FL788R	25	CVD	9 5/8
FL789R	30	CVD	9 5/8
FL790R	38	CVD	9 5/8



FL650R-FL662R

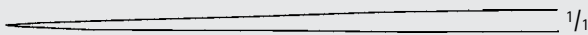

FL650R-FL662R



FL781R-FL790R



FL781R-FL790R



ORTHO
SPINE

INCHES

Orthopedics/Spine

Mallets



FL010-FL011

Mallet, PEEK

Catalog Number	Handle	Weight (gr)	Diameter (mm)	Length (in.)
FL010	HARTPRESS	230	42	9 3/4
FL011	HARTPRESS	315	50	9 3/4

Actual image color is blue

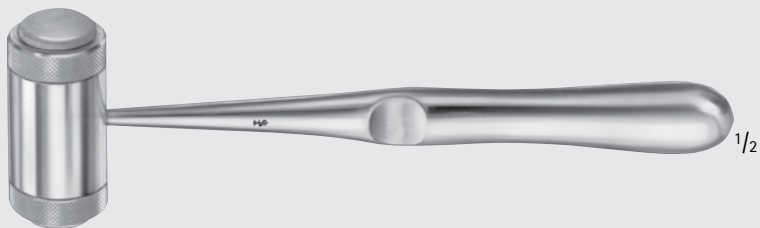

FL035R

MEAD Mallet, Removable Discs, 180gr

Catalog Number	Description	Diameter (mm)	Length (in.)
FL035R	COMPLETE	20	7 1/2
FL034	SPARE DISCS, F/FL035R, 2/SET	20	

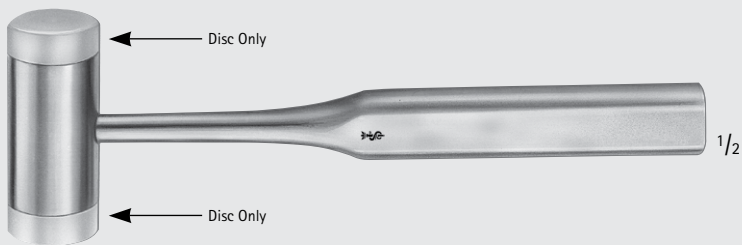

FL036R

Mallet W/ Removable Nylon Discs, 135gr

Catalog Number	Description	Diameter (mm)	Length (in.)
FL036R	COMPLETE	25	7 1/4
FL037	NYLON SPARE DISCS, F/FL036R, 2/SET	25	



MB629R

Mallet, 226gr

Catalog Number	Description	Diameter (mm)	Length (in.)
MB629R	ONE SIDE NYLON, ONE SIDE METAL	26	7 1/4
MB629200	REPLACEMENT NYLON DISC FOR MB629R MALLET HEAD		



DF114R

Mallet, 155gr

Catalog Number	Diameter (mm)	Length (in.)
DF114R	25	7 1/2



US142

Mallet, Copper

Catalog Number	Diameter (mm)	Length (in.)
US142	20	6 1/2

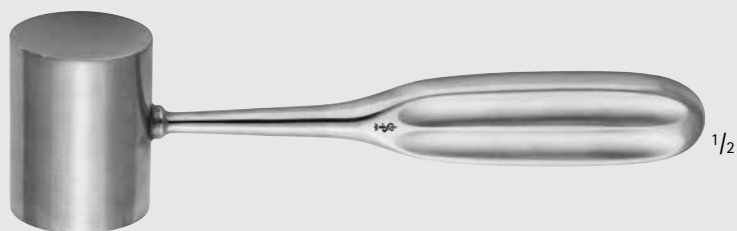

MG583R

KIRK Mallet, 560gr

Catalog Number	Diameter (mm)	Length (in.)
MG583R	35	7 1/4



Orthopedics/Spine

Mallets



FL038R

COTTLE Mallet, Flat/Round, 235gr

Catalog Number	Diameter (mm)	Length (in.)
FL038R	30	7 1/4



FL044R

HAJEK Mallet, 140gr

Catalog Number	Diameter (mm)	Length (in.)
FL044R	27	8 3/4



FL055R

BERGMANN Mallet, 260gr

Catalog Number	Diameter (mm)	Length (in.)
FL055R	30	9 1/4

PEEK



Mallet, 285gr, W/ Silicone Handle

Catalog Number	Diameter (mm)	Length (in.)
FL059R	30 / 42	9 1/2



FL059R

BERGMANN Mallet, 300gr, W/ Silicone Handle

Catalog Number	Diameter (mm)	Length (in.)
FL060R	45	9 5/8



FL060R

Orthopedic Mallet

Catalog Number	Diameter (mm)	Length (in.)
MB630R	30	7 1/4
MB631R	38	7 1/4

MB630R: 1 LB Weight (485gr)
 MB631R: 2 LB Weight (907gr)

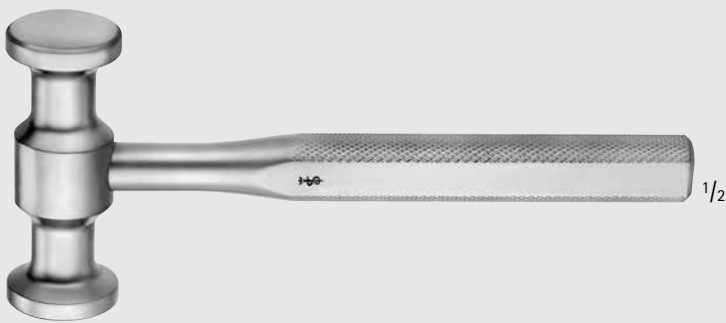

MB630R



ORTHO
SPINE

Orthopedics/Spine

Mallets



WAGNER Mallet Set, 130gr, W/ Silicone Handle

Catalog Number	Diameter (mm)	Length (in.)
FL062	35	9 1/4

Set includes:
 1 PR Metal Discs FL064R
 1 PR Plastic Discs FL065
 1 Wrench FL062/206

FL062

215 gr
1 Metal Disc, flat
1 Metal Disc, convex

FL064R

30 gr
1 Plastic Disc, flat
1 Plastic Disc, convex

FL065

OMBREDANNE Mallet, 520gr, W/ Silicone Handle

Catalog Number	Diameter (mm)	Length (in.)
FL066R	40	9 1/2

FL066R

HEATH Copper Head Mallet, 725gr, W/ Silicone Handle

Catalog Number	Diameter (mm)	Length (in.)
FL068R	40	9 1/4

FL068R



MG095R

HEATH Mallet, 823gr

Catalog Number	Diameter (mm)	Size	Length (in.)
MG095R	40	1.8 lbs	7 1/4



FLO90R

Bone Graft Tamper

Catalog Number	Diameter (mm)	Length (in.)
FLO90R	12	7 7/8



FLO90R

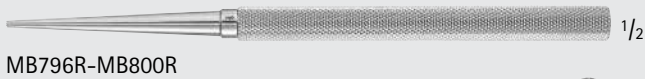

MB796R-MB800R

Bone Tamp

Catalog Number	Diameter (mm)	Length (in.)
MB796R	2	6 1/4
MB798R	4	6 1/4
MB800R	6	6 1/4
MB801R	8	6 1/4
MB802R	10	6 1/4



MB796R



MB798R



MB800R



MB801R



MB801R



MB802R



MB802R



FG093R-FG096R

SYPERT Spinal Impactor, W/ HART-PRESS Handle

Catalog Number	Tip Size (mm)	Length (in.)
FG093R	3 x 8	11 1/2
FG094R	4 x 10	11 1/2
FG095R	5 x 15	11 1/2
FG096R	6 x 20	11 1/2



FG093R



FG094R



FG095R



FG096R



ORTHO
SPINE

INCHES

Orthopedics/Spine

Bone Impactor

COBB Bone Impactor

Catalog Number	Tip Size (mm)	Length (in.)
MB545R	3 x 12	11 1/4



MB545R

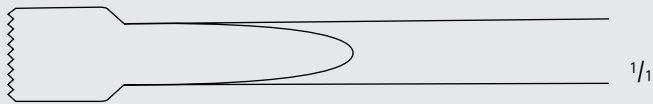

MB545R



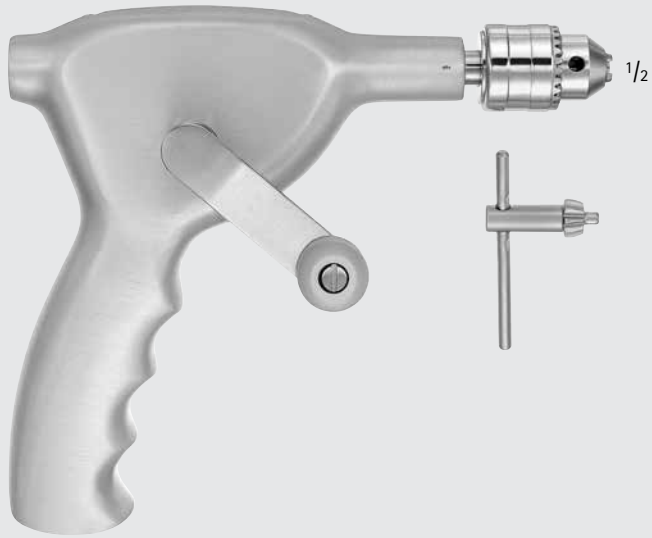

MG021R

RALKS Hand Drill, Cannulated

Catalog Number	Length (in.)
MG021R	6 1/4



Orthopedics/Spine

Drills, Burrs and Reamers



FR110R

1/2

CHAMPIONNIÈRE Bone Drill

Catalog Number	Length (in.)
FR110R	6 3/4



FR118R

1/2

Awl/Reamer

Catalog Number	Length (in.)
FR118R	6

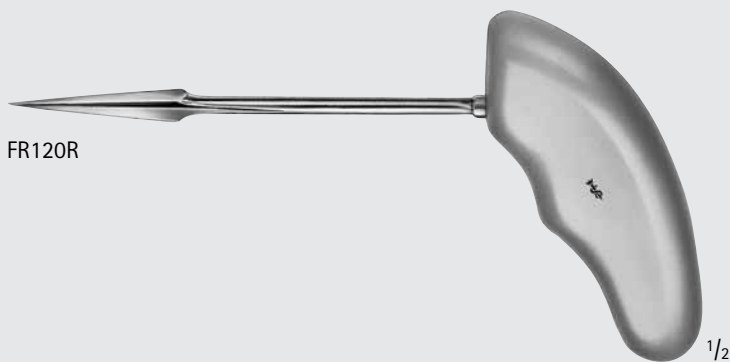

FR120R

1/2

Reamer

Catalog Number	Length (in.)
FR120R	7





FR125R

PERTHES Reamer

Catalog Number	Length (in.)
FR125R	8 1/2



FR140R-FR141R

Bone Biopsy Trephine

Catalog Number	Diameter (mm)	Length (in.)
FR140R	3.9 / 5	6 1/4
FR141R	6.4 / 8	6 1/4



FR140R



FR141R



Orthopedics/Spine

Curettes



FK845R

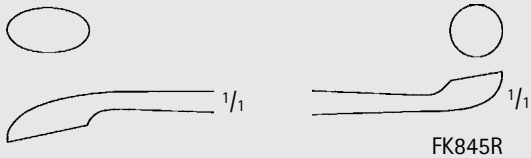

FK845R



FK846R

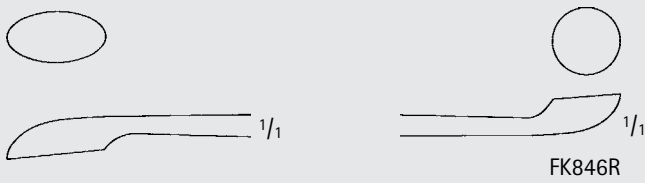

FK846R



FK848R

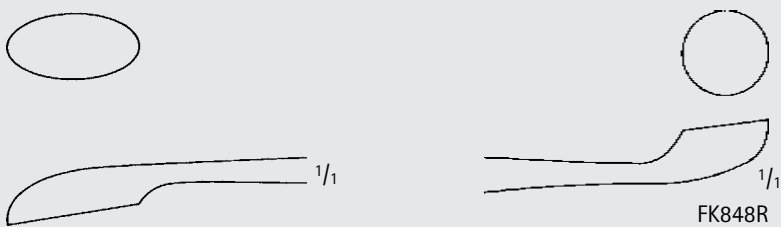

FK848R



FK850R

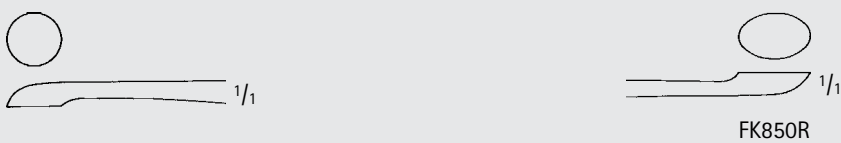

FK850R

Bone Curette, Double Ended

Catalog Number	Tip Size (mm)	Length (in.)
FK845R	6 / 7	5 1/8
FK846R	7 / 8	6 1/4
FK848R	8 / 11	7 7/8
FK850R	7 / 6	8 1/4



FK658R-FK659R

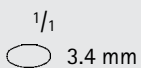

FK658R

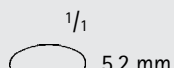

FK659R

WILLIGER Bone Curette

Catalog Number	Tip Size (#)	Tip Size (mm)	Length (in.)
FK658R	00	3.4	6 3/4
FK659R	1	5.2	6 3/4



FK611R-FK617R



^{1/1}
○ 3 mm
FK611R

^{1/1}
○ 4 mm
FK612R

^{1/1}
○ 5 mm
FK613R

^{1/1}
○ 6 mm
FK614R

^{1/1}
○ 8 mm
FK615R

^{1/1}
○ 10 mm
FK616R

^{1/1}
○ 12 mm
FK617R

BRUNS Curette, Round

Catalog Number	Tip Size (#)	Tip Size (mm)	Length (in.)
FK611R	000	3	6 1/2
FK612R	00	4	6 1/2
FK613R	0	5	6 1/2
FK614R	1	6	6 1/2
FK615R	2	8	6 1/2
FK616R	3	10	6 1/2
FK617R	4	12	6 1/2



FK621R-FK627R

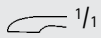

^{1/1}
○ 2.5 mm
FK621R

^{1/1}
○ 3.4 mm
FK622R

^{1/1}
○ 4.2 mm
FK623R

^{1/1}
○ 5.2 mm
FK624R

^{1/1}
○ 6.3 mm
FK625R

^{1/1}
○ 7.4 mm
FK626R

^{1/1}
○ 8 mm
FK627R

SCHEDE Curette

Catalog Number	Tip Size (#)	Tip Size (mm)	Length (in.)
FK621R	000	2.5	6 3/4
FK622R	00	3.4	6 3/4
FK623R	0	4.2	6 3/4
FK624R	1	5.2	6 3/4
FK625R	2	6.3	6 3/4
FK626R	3	7.4	6 3/4
FK627R	4	8.0	6 3/4



FK630R-FK639R



^{1/1}
○ 2.8 mm
FK630R

^{1/1}
○ 3.6 mm
FK631R

^{1/1}
○ 4.4 mm
FK632R

^{1/1}
○ 5.2 mm
FK633R

^{1/1}
○ 6.8 mm
FK634R

^{1/1}
○ 8.5 mm
FK635R

^{1/1}
○ 10 mm
FK636R

^{1/1}
○ 11.5 mm
FK637R

^{1/1}
○ 13 mm
FK638R

^{1/1}
○ 14.5 mm
FK639R

VOLKMANN Curette

Catalog Number	Tip Size (#)	Tip Size (mm)	Length (in.)
FK630R	0000	2.8	6 3/4
FK631R	000	3.6	6 3/4
FK632R	00	4.4	6 3/4
FK633R	0	5.2	6 3/4
FK634R	1	6.8	6 3/4
FK635R	2	8.5	6 3/4
FK636R	3	10.0	6 3/4
FK637R	4	11.5	6 3/4
FK638R	5	13.0	6 3/4
FK639R	6	14.5	6 3/4



ORTHO
SPINE

Orthopedics/Spine

Curettes



FK662R-FK665R

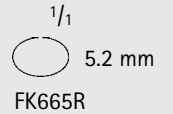
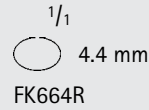
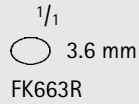
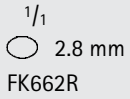
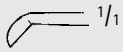

DAUBENSPECK Bone Curette

Catalog Number	Tip Size (#)	Tip Size (mm)	Length (in.)
FK662R	0000	2.8	7 7/8
FK663R	000	3.6	7 7/8
FK664R	00	4.4	7 7/8
FK665R	0	5.2	7 7/8



FK675R-FK679R

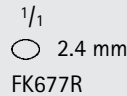
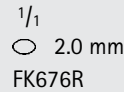
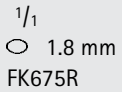
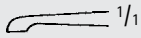

LEMPERT Bone Curette

Catalog Number	Tip Size (mm)	Length (in.)
FK675R	1.8	8 1/2
FK676R	2.0	8 1/2
FK677R	2.4	8 1/2
FK678R	2.6	8 1/2
FK679R	2.8	8 1/2

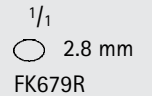
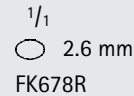

MD565-MD567



EPSTEIN Spinal Curette

Catalog Number	Tip Size (mm)	Size (#)	Length (in.)
MD565	2.0	000	8
MD566	2.5	00	8
MD567	3.0	0	8



SCOVILLE Bone Curette

Catalog Number	Tip Size (#)	Tip Size (mm)	Tip	Length (in.)
FK702R	000	3.6	FWD STR	9 3/4
FK703R	00	4.4	FWD STR	9 3/4
FK704R	0	5.2	FWD STR	9 3/4
FK705R	1	6.8	FWD STR	9 3/4
FK712R	000	3.6	FWD ANG	9 3/4
FK713R	00	4.4	FWD ANG	9 3/4
FK714R	0	5.2	FWD ANG	9 3/4
FK715R	1	6.8	FWD ANG	9 3/4



FK702R-FK715R

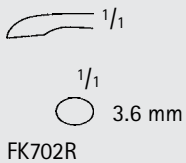

FK702R

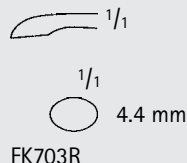

FK703R

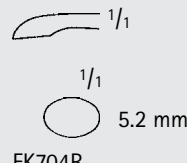

FK704R

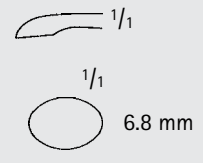

FK705R

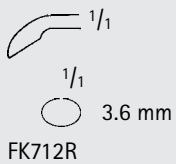

FK712R

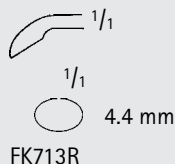

FK713R

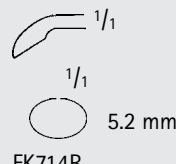

FK714R

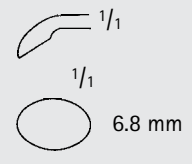

FK715R

BUSHE Bone Curette

Catalog Number	Tip Size (mm)	Tip	Length (in.)
FK723R	3.0	REV ANG	9 3/4
FK724R	4.0	REV ANG	9 3/4
FK725R	5.0	REV ANG	9 3/4



FK723R-FK725R

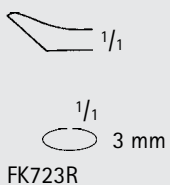

FK723R

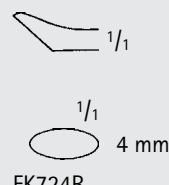

FK724R

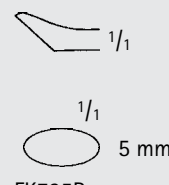

FK725R



ORTHO
SPINE

INCHES

Orthopedics/Spine

Curettes



MF519R-MD490, MF534R-MF544R, MF567R-MF577R

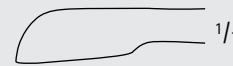

MF521R-MD481, MF545R-MF555R, MF578R-MF588R



MF523R-MF533R, MF556R-MF566R, MF589R-MF599R



BRUNS Spinal Curette

Catalog Number	Tip Size (#)	Tip	Length (in.)
MF519R	00000	STR	8
MF520R	0000	STR	8
MD482	000	STR	8
MD483	00	STR	8
MD484	0	STR	8
MD485	1	STR	8
MD486	2	STR	8
MD487	3	STR	8
MD488	4	STR	8
MD489	5	STR	8
MD490	6	STR	8
MF521R	00000	FWD ANG	8
MF522R	0000	FWD ANG	8
MD473	000	FWD ANG	8
MD474	00	FWD ANG	8
MD475	0	FWD ANG	8
MD476	1	FWD ANG	8
MD477	2	FWD ANG	8
MD478	3	FWD ANG	8
MD479	4	FWD ANG	8
MD480	5	FWD ANG	8
MD481	6	FWD ANG	8
MF523R	00000	REV ANG	8
MF524R	0000	REV ANG	8
MF525R	000	REV ANG	8
MF526R	00	REV ANG	8
MF527R	0	REV ANG	8
MF528R	1	REV ANG	8
MF529R	2	REV ANG	8
MF530R	3	REV ANG	8
MF531R	4	REV ANG	8
MF532R	5	REV ANG	8
MF533R	6	REV ANG	8

Catalog Number	Tip Size (#)	Tip	Length (in.)
MF534R	00000	STR	9
MF535R	0000	STR	9
MF536R	000	STR	9
MF537R	00	STR	9
MF538R	0	STR	9
MF539R	1	STR	9
MF540R	2	STR	9
MF541R	3	STR	9
MF542R	4	STR	9
MF543R	5	STR	9
MF544R	6	STR	9
MF545R	00000	FWD ANG	9
MF546R	0000	FWD ANG	9
MF547R	000	FWD ANG	9
MF548R	00	FWD ANG	9
MF549R	0	FWD ANG	9
MF550R	1	FWD ANG	9
MF551R	2	FWD ANG	9
MF552R	3	FWD ANG	9
MF553R	4	FWD ANG	9
MF554R	5	FWD ANG	9
MF555R	6	FWD ANG	9
MF556R	00000	REV ANG	9
MF557R	0000	REV ANG	9
MF558R	000	REV ANG	9
MF559R	00	REV ANG	9
MF560R	0	REV ANG	9
MF561R	1	REV ANG	9
MF562R	2	REV ANG	9
MF563R	3	REV ANG	9
MF564R	4	REV ANG	9
MF565R	5	REV ANG	9
MF566R	6	REV ANG	9

Catalog Number	Tip Size (#)	Tip	Length (in.)
MF567R	00000	STR	12
MF568R	0000	STR	12
MF569R	000	STR	12
MF570R	00	STR	12
MF571R	0	STR	12
MF572R	1	STR	12
MF573R	2	STR	12
MF574R	3	STR	12
MF575R	4	STR	12
MF576R	5	STR	12
MF577R	6	STR	12
MF578R	00000	FWD ANG	12
MF579R	0000	FWD ANG	12
MF580R	000	FWD ANG	12
MF581R	00	FWD ANG	12
MF582R	0	FWD ANG	12
MF583R	1	FWD ANG	12
MF584R	2	FWD ANG	12
MF585R	3	FWD ANG	12
MF586R	4	FWD ANG	12
MF587R	5	FWD ANG	12
MF588R	6	FWD ANG	12
MF589R	00000	REV ANG	12
MF590R	0000	REV ANG	12
MF591R	000	REV ANG	12
MF592R	00	REV ANG	12
MF593R	0	REV ANG	12
MF594R	1	REV ANG	12
MF595R	2	REV ANG	12
MF596R	3	REV ANG	12
MF597R	4	REV ANG	12
MF598R	5	REV ANG	12
MF599R	6	REV ANG	12





MB872R-MB880R



BRUNS Curette

Catalog Number	Tip Size (#)	Tip Size (mm)	Tip	Length (in.)
MB872R	000	2.0	STR	9
MB873R	00	2.5	STR	9
MB874R	0	3.3	STR	9
MB875R	1	3.8	STR	9
MB876R	2	4.8	STR	9
MB877R	3	5.3	STR	9
MB878R	4	6.0	STR	9
MB879R	5	6.7	STR	9
MB880R	6	7.3	STR	9



FK688R-FK690R



SIMON Bone Curette

Catalog Number	Tip Size (#)	Tip Size (mm)	Length (in.)
FK688R	000	3.6	9 1/4
FK689R	00	4.4	9 1/4
FK690R	0	5.2	9 1/4



MB415R-MB417R



HIBBS Curette

Catalog Number	Tip	Length (in.)
MB415R	SMALL	8
MB416R	MEDIUM	8
MB417R	LARGE	8



ORTHO
SPINE

INCHES

Orthopedics/Spine

Curettes



Bone Curette, Long, W/ PEEK Handle

Catalog Number	Tip Size (#)	Tip Size (mm)	Length (in.)
FK666R	00	4.4	10 5/8
FK668R	1	6.8	10 5/8
FK670R	2	8.5	10 5/8
FK672R	3	10.0	10 5/8



FK666R-FK672R

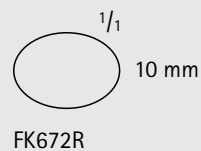
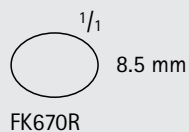
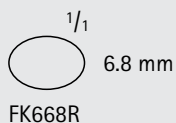
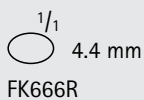
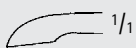

CASPAR Curette, W/ PEEK Handle

Catalog Number	Tip Size (#)	Tip Size (mm)	Blade	Length (in.)
FK773R	000	3.6	STR	8 3/4
FK774R	00	4.4	STR	8 3/4
FK775R	0	5.2	STR	8 3/4
FK783R	000	3.6	CVD	8 3/4
FK784R	00	4.4	CVD	8 3/4
FK785R	0	5.2	CVD	8 3/4



FK773R-FK775R

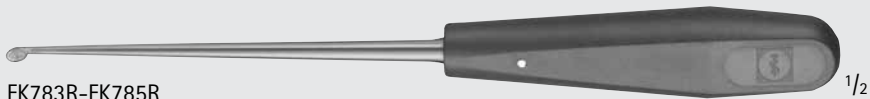
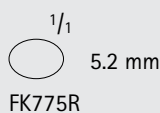
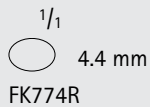
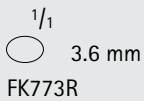
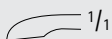

FK783R-FK785R

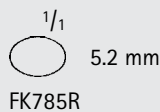
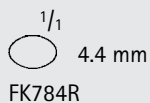
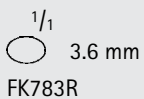
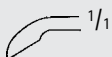

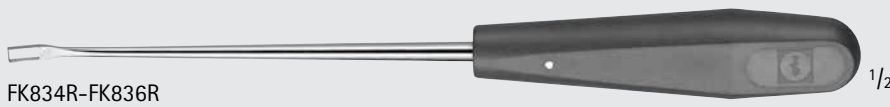

CASPAR Curette, W/ PEEK Handle

Catalog Number	Tip Size (mm)	Tip	Length (in.)
FK834R	4	SQUARE	8 3/4
FK835R	5	SQUARE	8 3/4
FK836R	6	SQUARE	8 3/4

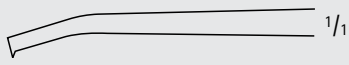

4 mm  1/1
FK834R

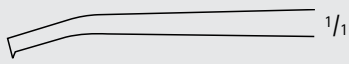

5 mm  1/1
FK835R

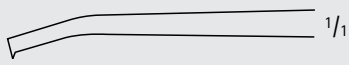

6 mm  1/1
FK836R



Orthopedics/Spine

Curettes



CASPAR Bone Curette, Toothed

Catalog Number	Tip Size (mm)	Tip	Length (in.)
FK854R	4.0	SQUARE	9 3/4
FK855R	5.0	SQUARE	9 3/4



FK854R-FK855R

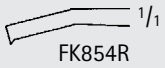

FK854R

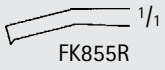

FK855R

CASPAR Bone Curette, Toothed

Catalog Number	Tip Size (mm)	Tip	Length (in.)
FK863R	3.0	SQUARE, ANG	10 5/8
FK864R	4.0	SQUARE, ANG	10 5/8



FK863R-FK864R

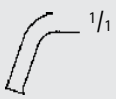

FK863R

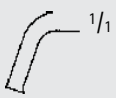

FK864R

COBB Curette

Catalog Number	Tip Size (#)	Tip Size (mm)	Tip	Length (in.)
FK581R	000	2.0	STR	11
FK582R	00	2.5	STR	11
FK583R	0	3.0	STR	11
FK584R	1	3.5	STR	11
FK585R	2	4.5	STR	11
FK586R	3	5.5	STR	11
FK587R	4	7.5	STR	11
FK588R	5	8.5	STR	11
FK589R	6	10.0	STR	11
FK591R	000	2.0	ANG	11
FK592R	00	2.5	ANG	11
FK593R	0	3.0	ANG	11
FK594R	1	3.5	ANG	11
FK595R	2	4.5	ANG	11
FK596R	3	5.5	ANG	11
FK597R	4	7.5	ANG	11
FK598R	5	8.5	ANG	11
FK599R	6	10.0	ANG	11

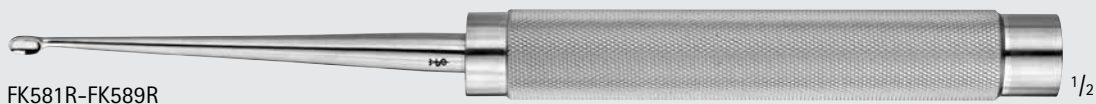

FK581R-FK589R



FK591R-FK599R

¹/₁
○ 2.0 mm
FK581R, FK591R

¹/₁
○ 2.5 mm
FK582R, FK592R

¹/₁
○ 3.0 mm
FK583R, FK593R

¹/₁
○ 3.5 mm
FK584R, FK594R

¹/₁
○ 4.5 mm
FK585R, FK595R

¹/₁
○ 5.5 mm
FK586R, FK596R

¹/₁
○ 7.5 mm
FK587R, FK597R

¹/₁
○ 8.5 mm
FK588R, FK598R

¹/₁
○ 10.0 mm
FK589R, FK599R



INCHES

Orthopedics/Spine

Curettes

Colored Cervical Curette

Catalog Number	Tip Size (#)	Tip	Color	Length (in.)
MD216R	000000	STR	RED	10
MD217R	00000	STR	SILVER	10
MD218R	0000	STR	PURPLE	10
MD219R	000	STR	TURQUOISE	10
MD220R	00	STR	GOLD	10
MD221R	0	STR	GREEN	10
MD222R	1	STR	ORANGE	10
MD223R	2	STR	BLUE	10
MD224R	3	STR	GRAY	10
MD225R	4	STR	BLACK	10
MD226R	5	STR	BLACK	10
MD227R	6	STR	BLACK	10
MD234R	000000	ANG	RED	10
MD235R	00000	ANG	SILVER	10
MD236R	0000	ANG	PURPLE	10
MD237R	000	ANG	TURQUOISE	10
MD238R	00	ANG	GOLD	10
MD239R	0	ANG	GREEN	10
MD240R	1	ANG	ORANGE	10
MD241R	2	ANG	BLUE	10
MD242R	3	ANG	GRAY	10
MD243R	4	ANG	BLACK	10
MD244R	5	ANG	BLACK	10
MD245R	6	ANG	BLACK	10

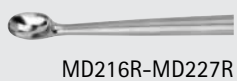

Colored Cervical Curette

Catalog Number	Tip Size (#)	Tip	Color	Length (in.)
MD309R	000000	REVERSE ANG	RED	10
MD310R	00000	REVERSE ANG	SILVER	10
MD311R	0000	REVERSE ANG	PURPLE	10
MD312R	000	REVERSE ANG	TURQUOISE	10
MD313R	00	REVERSE ANG	GOLD	10
MD314R	0	REVERSE ANG	GREEN	10
MD315R	1	REVERSE ANG	ORANGE	10
MD316R	2	REVERSE ANG	BLUE	10
MD317R	3	REVERSE ANG	GRAY	10
MD318R	4	REVERSE ANG	BLACK	10
MD319R	5	REVERSE ANG	BLACK	10
MD320R	6	REVERSE ANG	BLACK	10
MD383R	000000	ANG 90°	RED	10
MD384R	00000	ANG 90°	SILVER	10
MD385R	0000	ANG 90°	PURPLE	10
MD386R	000	ANG 90°	TURQUOISE	10
MD387R	00	ANG 90°	GOLD	10
MD388R	0	ANG 90°	GREEN	10
MD389R	1	ANG 90°	ORANGE	10
MD390R	2	ANG 90°	BLUE	10
MD391R	3	ANG 90°	GRAY	10
MD392R	4	ANG 90°	BLACK	10
MD393R	5	ANG 90°	BLACK	10
MD394R	6	ANG 90°	BLACK	10

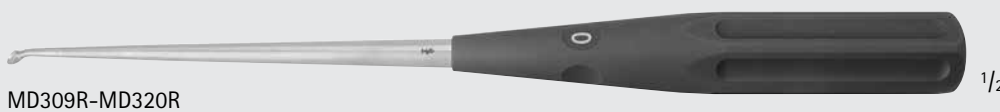

MD309R-MD320R



MD309R-MD320R

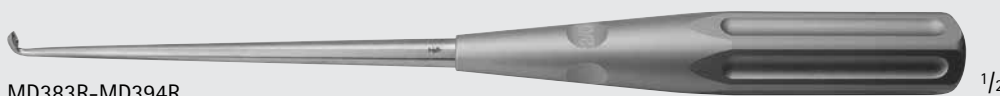

MD383R-MD394R



MD383R-MD394R



Orthopedics/Spine

Curettes

Colored Lumbar Curette

Catalog Number	Tip Size (#)	Tip	Color	Length (in.)
MD500R	000000	STR	RED	13 3/4
MD501R	00000	STR	SILVER	13 3/4
MD502R	0000	STR	PURPLE	13 3/4
MD503R	000	STR	TURQUOISE	13 3/4
MD504R	00	STR	GOLD	13 3/4
MD505R	0	STR	GREEN	13 3/4
MD506R	1	STR	ORANGE	13 3/4
MD507R	2	STR	BLUE	13 3/4
MD508R	3	STR	GRAY	13 3/4
MD509R	4	STR	BLACK	13 3/4
MD510R	5	STR	BLACK	13 3/4
MD511R	6	STR	BLACK	13 3/4
MD620R	000000	ANG	RED	13 3/4
MD621R	00000	ANG	SILVER	13 3/4
MD622R	0000	ANG	PURPLE	13 3/4
MD623R	000	ANG	TURQUOISE	13 3/4
MD624R	00	ANG	GOLD	13 3/4
MD625R	0	ANG	GREEN	13 3/4
MD626R	1	ANG	ORANGE	13 3/4
MD627R	2	ANG	BLUE	13 3/4
MD628R	3	ANG	GRAY	13 3/4
MD629R	4	ANG	BLACK	13 3/4
MD630R	5	ANG	BLACK	13 3/4
MD631R	6	ANG	BLACK	13 3/4
MD632R	000000	REVERSE ANG	RED	13 3/4
MD633R	00000	REVERSE ANG	SILVER	13 3/4
MD634R	0000	REVERSE ANG	PURPLE	13 3/4
MD635R	000	REVERSE ANG	TURQUOISE	13 3/4
MD636R	00	REVERSE ANG	GOLD	13 3/4
MD637R	0	REVERSE ANG	GREEN	13 3/4
MD638R	1	REVERSE ANG	ORANGE	13 3/4
MD639R	2	REVERSE ANG	BLUE	13 3/4
MD640R	3	REVERSE ANG	GRAY	13 3/4
MD641R	4	REVERSE ANG	BLACK	13 3/4
MD642R	5	REVERSE ANG	BLACK	13 3/4
MD643R	6	REVERSE ANG	BLACK	13 3/4



Bayonet Curette

Catalog Number	Tip	Tip Size (#)	Length (in.)
MD660R	STR	0	9
MD661R	STR	00	9
MD662R	STR	000	9
MD663R	STR	0000	9
MD664R	STR	00000	9
MD655R	REVERSE ANG UP	0	9
MD656R	REVERSE ANG UP	00	9
MD657R	REVERSE ANG UP	000	9
MD658R	REVERSE ANG UP	0000	9
MD659R	REVERSE ANG UP	00000	9
MD665R	REVERSE ANG DOWN	0	9
MD666R	REVERSE ANG DOWN	00	9
MD667R	REVERSE ANG DOWN	000	9
MD668R	REVERSE ANG DOWN	0000	9
MD669R	REVERSE ANG DOWN	00000	9

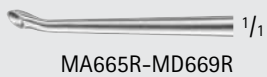
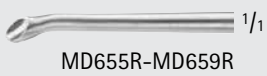

ORTHO
SPINE

Orthopedics/Spine

Curettes

Black Handle Curette

Catalog Number	Tip	Tip Size (#)	Handle	Length (in.)
MN012R	STR	000	8 1/2	13 1/4
MN013R	STR	00	8 1/2	13 1/4
MN014R	STR	0	8 1/2	13 1/4
MN015R	STR	1	8 1/2	13 1/4
MN016R	STR	2	8 1/2	13 1/4
MN017R	STR	3	8 1/2	13 1/4
MN018R	STR	4	8 1/2	13 1/4
MN019R	STR	5	8 1/2	13 1/4
MN020R	STR	6	8 1/2	13 1/4
MN021R	STR	7	8 1/2	13 1/4
MN022R	ANG	000	8 1/2	13 1/4
MN023R	ANG	00	8 1/2	13 1/4
MN024R	ANG	0	8 1/2	13 1/4
MN025R	ANG	1	8 1/2	13 1/4
MN026R	ANG	2	8 1/2	13 1/4
MN027R	ANG	3	8 1/2	13 1/4
MN028R	ANG	4	8 1/2	13 1/4
MN029R	ANG	5	8 1/2	13 1/4
MN030R	ANG	6	8 1/2	13 1/4
MN031R	ANG	7	8 1/2	13 1/4
MN032R	REVERSE ANG	000	8 1/2	13 1/4
MN033R	REVERSE ANG	00	8 1/2	13 1/4
MN034R	REVERSE ANG	0	8 1/2	13 1/4
MN035R	REVERSE ANG	1	8 1/2	13 1/4
MN036R	REVERSE ANG	2	8 1/2	13 1/4
MN037R	REVERSE ANG	3	8 1/2	13 1/4
MN038R	REVERSE ANG	4	8 1/2	13 1/4
MN039R	REVERSE ANG	5	8 1/2	13 1/4
MN040R	REVERSE ANG	6	8 1/2	13 1/4
MN041R	REVERSE ANG	7	8 1/2	13 1/4



MN012R-MN021R



MN022R-MN031R



MN032R-MN041R



XL Black Handled Curette

Catalog Number	Tip	Tip Size (#)	Handle	Length (in.)
MN042R	STR	000	9	15
MN043R	STR	00	9	15
MN044R	STR	0	9	15
MN045R	STR	1	9	15
MN046R	STR	2	9	15
MN047R	STR	3	9	15
MN048R	STR	4	9	15
MN049R	STR	5	9	15
MN050R	STR	6	9	15
MN051R	STR	7	9	15
MN052R	ANG	000	9	15
MN053R	ANG	00	0	15
MN054R	ANG	0	0	15
MN055R	ANG	1	9	15
MN056R	ANG	2	9	15
MN057R	ANG	3	9	15
MN058R	ANG	4	9	15
MN059R	ANG	5	9	15
MN060R	ANG	6	9	15
MN061R	ANG	7	9	15
MN062R	REVERSE ANG	000	9	15
MN063R	REVERSE ANG	00	9	15
MN064R	REVERSE ANG	0	9	15
MN065R	REVERSE ANG	1	9	15
MN066R	REVERSE ANG	2	9	15
MN067R	REVERSE ANG	3	9	15
MN068R	REVERSE ANG	4	9	15
MN069R	REVERSE ANG	5	9	15
MN070R	REVERSE ANG	6	9	15
MN071R	REVERSE ANG	7	9	15



MN042R-MN051R



MN052R-MN061R



MN062R-MN071R



Orthopedics/Spine

Curettes and Microdissecting Instruments

Micro Profile Instruments

Catalog Number	Description	Tip Size (#)	Tip	Length (in.)
MN087R	DISSECTOR	3 MM	STR	10 1/4
MN088R	DISSECTOR	5 MM	STR	10 1/4
MN077R	CURETTE	1	ANG	10 1/4
MN079R	CURETTE	2	ANG	10 1/4
MN081R	CURETTE	3	ANG	10 1/4
MN083R	CURETTE	4	ANG	10 1/4
MN085R	CURETTE	5	ANG	10 1/4
MN078R	CURETTE	1	REV-ANG	10 1/4
MN080R	CURETTE	2	REV-ANG	10 1/4
MN082R	CURETTE	3	REV-ANG	10 1/4
MN084R	CURETTE	4	REV-ANG	10 1/4
MN086R	CURETTE	5	REV-ANG	10 1/4



Orthopedics/Spine

Microdiscectomy Instruments

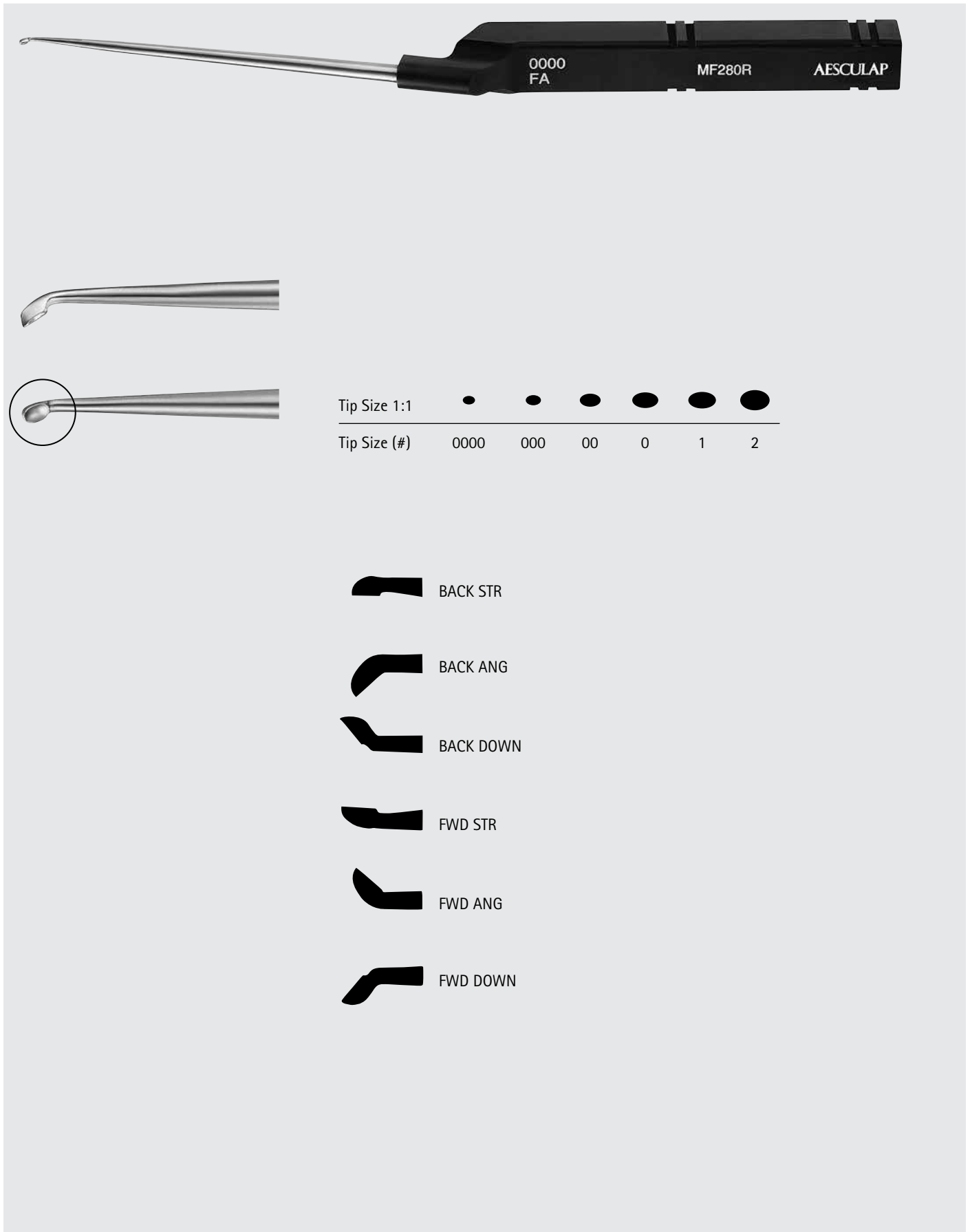

Orthopedics/Spine

Microdiscectomy Instruments

Microdiscectomy Cervical Instruments

Catalog Number	Tip Size (#)	Tip	Length (in.)
MF250	COMPLETE SET (Includes One Each of All Items Listed)		
MF251R	0	FWD STR	8 1/2
MF252R	00	FWD STR	8 1/2
MF253R	000	FWD STR	8 1/2
MF254R	0000	FWD STR	8 1/2
MF255R	Bone Cutter	FWD STR	8 1/2
MF256R	0	FWD ANG	8 1/2
MF257R	00	FWD ANG	8 1/2
MF258R	000	FWD ANG	8 1/2
MF259R	0000	FWD ANG	8 1/2
MF260R	Bone Cutter	FWD ANG	8 1/2
MF261R	0	BACK STR	8 1/2
MF262R	00	BACK STR	8 1/2
MF263R	000	BACK STR	8 1/2
MF264R	0000	BACK STR	8 1/2
MF265R	Bone Cutter	BACK STR	8 1/2
MF266R	0	BACK ANG	8 1/2
MF267R	00	BACK ANG	8 1/2
MF268R	000	BACK ANG	8 1/2
MF269R	0000	BACK ANG	8 1/2
MF270R	Bone Cutter	BACK ANG	8 1/2
MF321R		MICRO NERVE HOOK	8 1/2
MF322R		ULTRA MICRO NERVE HOOK	8 1/2
MF323R		BONE WAXER	8 1/2
MF320	Case - 12 Instruments (Set includes 2 cases)		

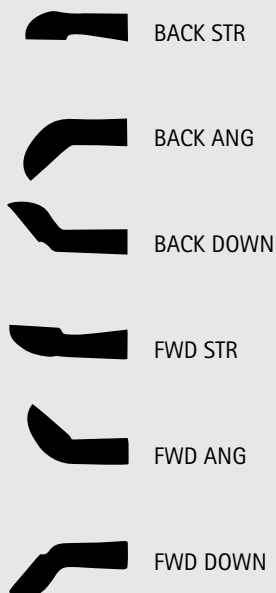

Microdiscectomy Cervical Long Instruments

Catalog Number	Tip Size (#)	Tip	Length (in.)
MF271	COMPLETE SET (Includes One Each of All Items Listed)		
MF272R	0	FWD STR	9 1/2
MF273R	00	FWD STR	9 1/2
MF274R	000	FWD STR	9 1/2
MF275R	0000	FWD STR	9 1/2
MF276R	Bone Cutter	FWD STR	9 1/2
MF277R	0	FWD ANG	9 1/2
MF278R	00	FWD ANG	9 1/2
MF279R	000	FWD ANG	9 1/2
MF280R	0000	FWD ANG	9 1/2
MF281R	Bone Cutter	FWD ANG	9 1/2
MF282R	0	BACK STR	9 1/2
MF283R	00	BACK STR	9 1/2
MF284R	000	BACK STR	9 1/2
MF285R	0000	BACK STR	9 1/2
MF286R	Bone Cutter	BACK STR	9 1/2
MF287R	0	BACK ANG	9 1/2
MF288R	00	BACK ANG	9 1/2
MF289R	000	BACK ANG	9 1/2
MF290R	0000	BACK ANG	9 1/2
MF291R	Bone Cutter	BACK ANG	9 1/2
MF292R		NERVE HOOK	9 1/2
MF293R		ULTRA MICRO NERVE HOOK	9 1/2
MF294R			9 1/2
MF320	Case - 12 Instruments (Set includes 2 cases)		

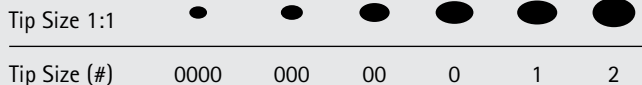

Microdiscectomy Lumbar Instruments

Catalog Number	Tip Size (#)	Tip	Length (in.)
MF295	COMPLETE SET (Includes One Each of All Items Listed)		
MF296R	0	FWD STR	9 1/2
MF297R	1	FWD STR	9 1/2
MF298R	2	FWD STR	9 1/2
MF299R	0	FWD ANG	9 1/2
MF300R	1	FWD ANG	9 1/2
MF301R	2	FWD ANG	9 1/2
MF302R	0	FWD DOWN	9 1/2
MF303R	1	FWD DOWN	9 1/2
MF304R	2	FWD DOWN	9 1/2
MF305R	0	BACK STR	9 1/2
MF306R	1	BACK STR	9 1/2
MF307R	2	BACK STR	9 1/2
MF308R	0	BACK ANG	9 1/2
MF309R	1	BACK ANG	9 1/2
MF310R	2	BACK ANG	9 1/2
MF311R	0	BACK DOWN	9 1/2
MF312R	1	BACK DOWN	9 1/2
MF313R	2	BACK DOWN	9 1/2
MF314R		#1 PENFIELD	9 1/2
MF315R		#2 PENFIELD	9 1/2
MF316R		NERVE HOOK	9 1/2
MF317R		#4 PENFIELD	9 1/2
MF318R		BONE WAXER	9 1/2
MF319R		SPINE PROBE	9 1/2
MF320	Case - 12 Instruments (Set includes 2 cases)		

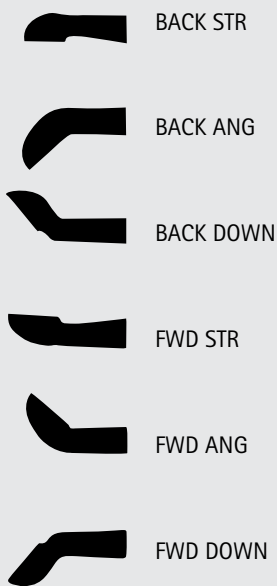

Tip Size 1:1

Tip Size (#)

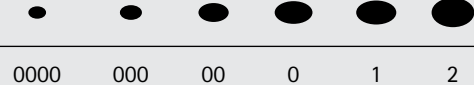

Orthopedics/Spine

Microdiscectomy Instruments



Storage Case for Microdiscectomy Instruments

Catalog Number
MF320

MF320

1/4



FB141R-FB143R



LEMMON Intima Dissector

Catalog Number	Tip	Length (in.)
FB141R	SLIGHT-CVD	6 1/2
FB142R	CVD	6 1/2
FB143R	HEAVY-CVD	6 1/2



MB456R



BUNNELL Dissecting Probe

Catalog Number	Tip	Length (in.)
MB456R	ANG	5 1/2



FK292R-FK293R

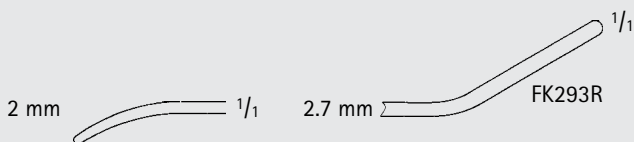
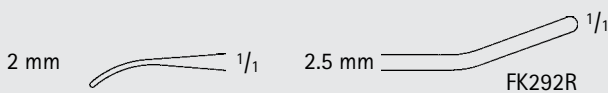

WATSON-CHEYNE Dissector, Double Ended

Catalog Number	Blade Size (mm)	Length (in.)
FK292R	2 / 2.5	5 1/8
FK293R	2 / 2.7	7 1/2



INCHES

Orthopedics/Spine

Rongeurs

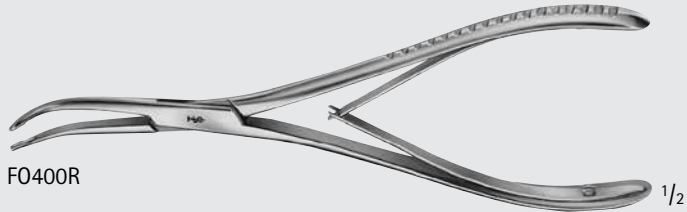
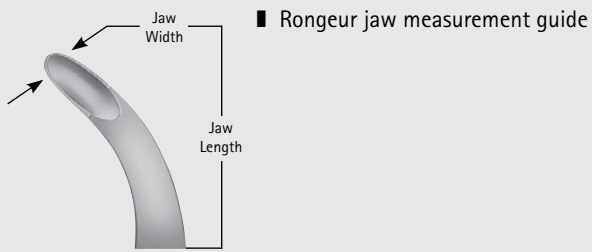

STELLBRINK Synovectomy Rongeur

Catalog Number	Jaw Size (mm)	Jaw	Length (in.)
FO399R	2.0 x 39.5	SLIGHT-CVD	6 7/8
FO400R	2 x 33	CVD	6 3/4



Synovectomy Rongeur

Catalog Number	Jaw Size (mm)	Jaw	Length (in.)
FO599R	1.8 x 24	CVD	5 1/8



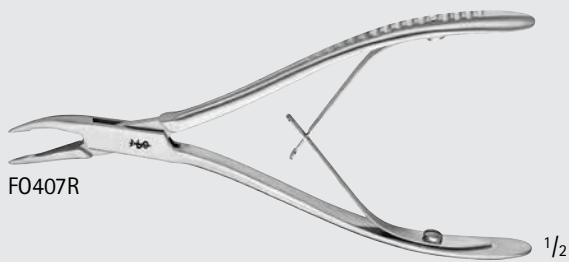
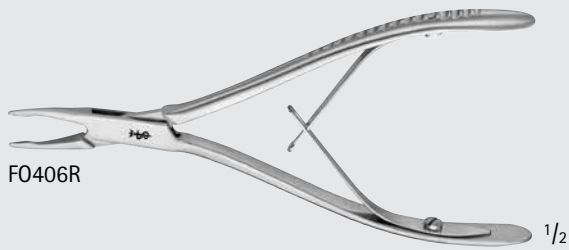

FRIEDMANN Micro Rongeur

Catalog Number	Jaw Size (mm)	Jaw	Length (in.)
FO406R	1.3 x 19	STR	5 1/2
FO407R	1.3 x 20	CVD	5 1/2

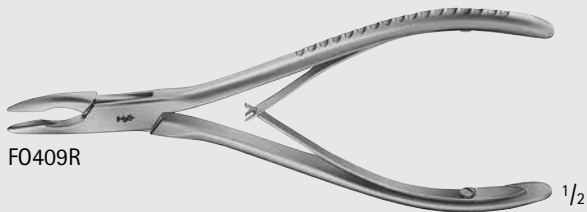

LUER-FRIEDMANN Bone Rongeur

Catalog Number	Jaw Size (mm)	Jaw	Length (in.)
FO409R	2.2 x 22	CVD	5 3/4

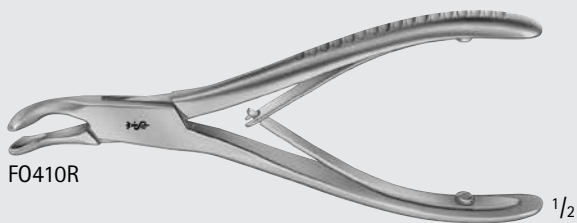

Bone Rongeur

Catalog Number	Jaw Size (mm)	Jaw	Length (in.)
FO410R	3.8 x 19	CVD	5 1/2



Orthopedics/Spine

Rongeurs

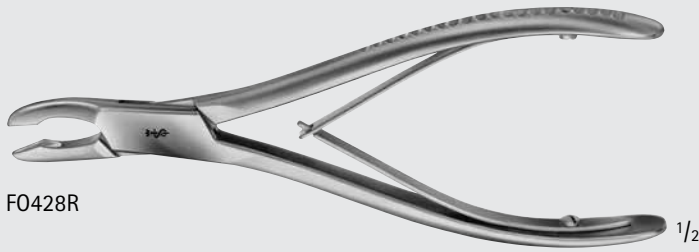

FO428R



FO428R

HAKANSSON Bone Rongeur

Catalog Number	Jaw Size (mm)	Jaw	Length (in.)
FO428R	4.5 x 24	CVD	6 3/4

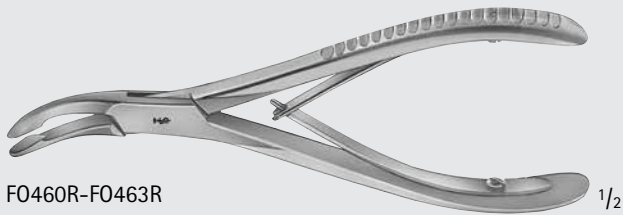

FO460R-FO463R



FO460R



FO462R



FO411R



FO412R



FO461R

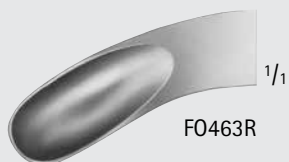

FO463R

LUER Bone Rongeur

Catalog Number	Jaw Size (mm)	Jaw	Length (in.)
FO460R	7.5 x 25	STR	6 7/8
FO462R	9.5 x 33	STR	7
FO411R	4.2 x 20	CVD	6
FO412R	4.2 x 26	STRONG CVD	6 1/8
FO461R	7.5 x 24.5	CVD	6 7/8
FO463R	9.0 x 30	CVD	7



BLUMENTHAL Bone Rongeur

Catalog Number	Jaw Size (mm)	Jaw	Length (in.)
FO415R	3.5 x 25	30° CVD	6 1/8
FO416R	3.5 x 22	45° CVD	6

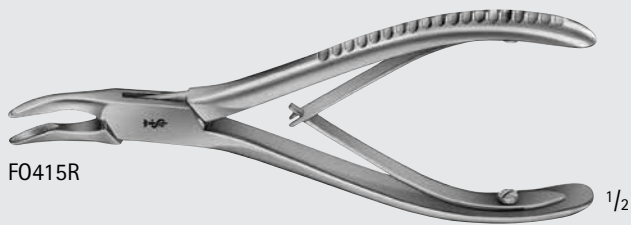

JANSEN Bone Rongeur

Catalog Number	Jaw Size (mm)	Jaw	Length (in.)
FO430R	4.2 x 35	STR	6 7/8
FO432R	4.5 x 30	CVD	6 7/8
FO442R	3.8 x 37	ANG	7 1/2

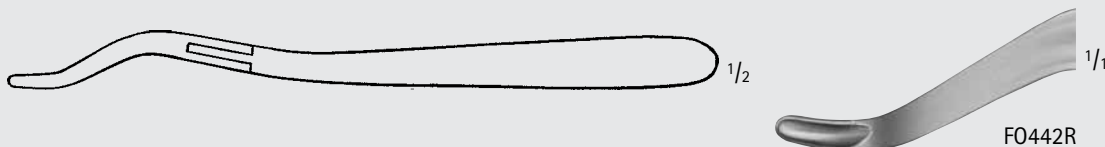
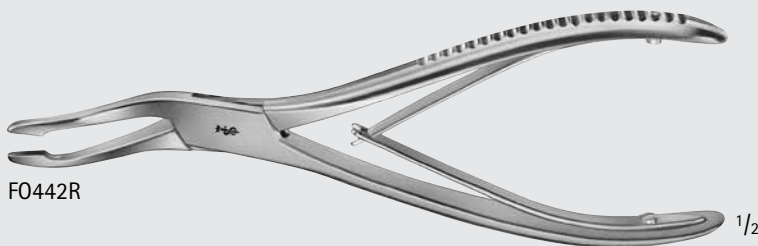

Orthopedics/Spine

Rongeurs

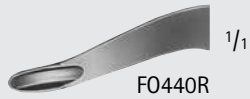

ALEXANDER Bone Rongeur

Catalog Number	Jaw Size (mm)	Jaw	Length (in.)
FO440R	3.2 x 27	ANG	5 1/2

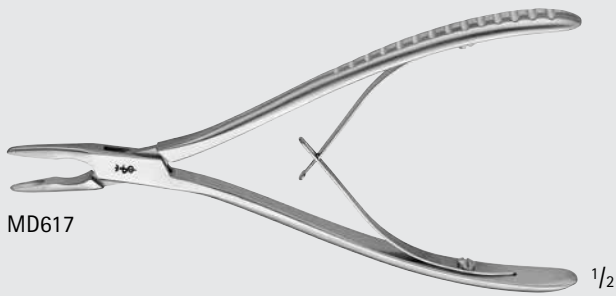

LEMPERT Bone Rongeur

Catalog Number	Jaw Size (mm)	Jaw	Length (in.)
MD617	2.0 x 23	DEL, STR	6 1/2
FO450R	2.2 x 27	STR	7 7/8
MG059R	2.5 x 30	CVD	6 1/4
FO451R	2.2 x 27	CVD	7 7/8

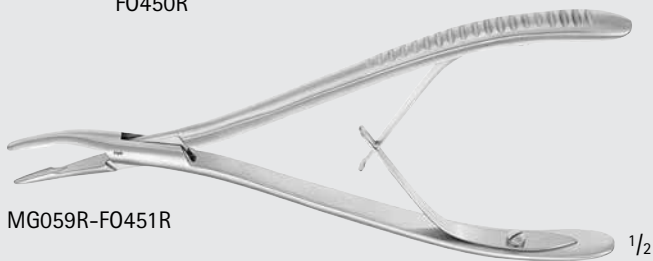
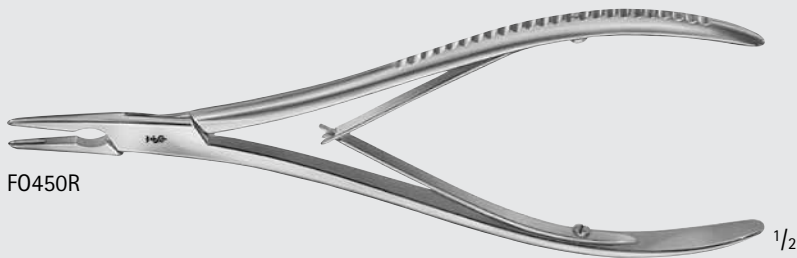

BEYER Bone Rongeur

Catalog Number	Jaw Size (mm)	Jaw	Length (in.)
F0453R	3.2 x 32	CVD	7

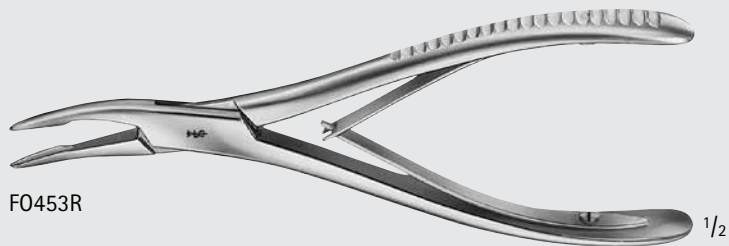

F0453R

1/2



F0453R

1/1

MEAD Bone Rongeur

Catalog Number	Jaw Size (mm)	Jaw	Length (in.)
F0455R	3.5 x 30	CVD	6 1/2

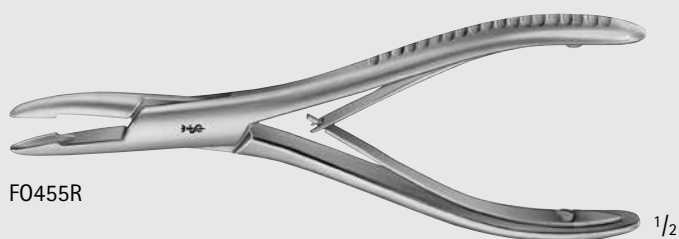

F0455R

1/2



F0455R

1/1

BANE-HARTMANN Bone Rongeur

Catalog Number	Jaw Size (mm)	Jaw	Length (in.)
F0457R	4.0 x 32	CVD	6 7/8

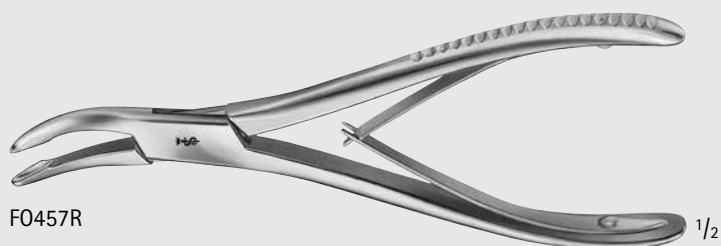

F0457R

1/2



F0457R

1/1



ORTHO
SPINE

INCHES

Orthopedics/Spine

Rongeurs

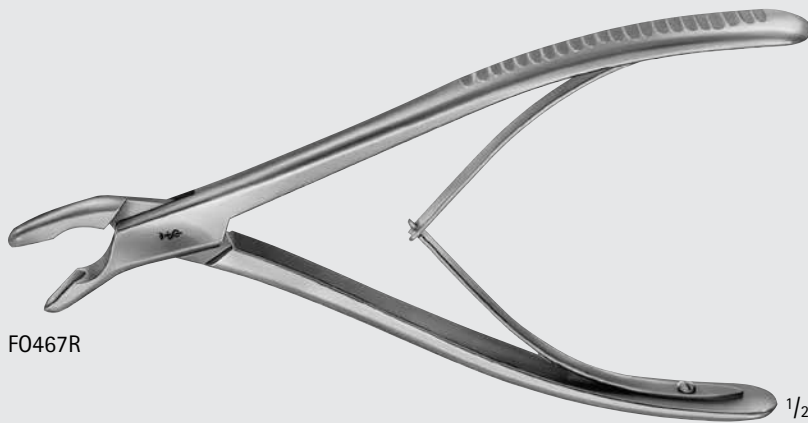

FO467R

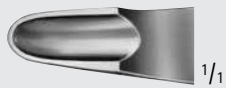

FO467R

TROTTER Bone Rongeur

Catalog Number	Jaw Size (mm)	Jaw	Length (in.)
FO467R	6.5 x 24	CVD	8



FO470R

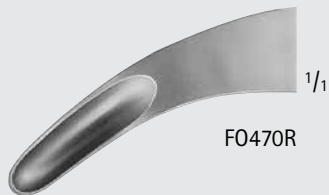

FO470R

OLIVECRONA Bone Rongeur

Catalog Number	Jaw Size (mm)	Jaw	Length (in.)
FO470R	5.0 x 36.5	CVD	8

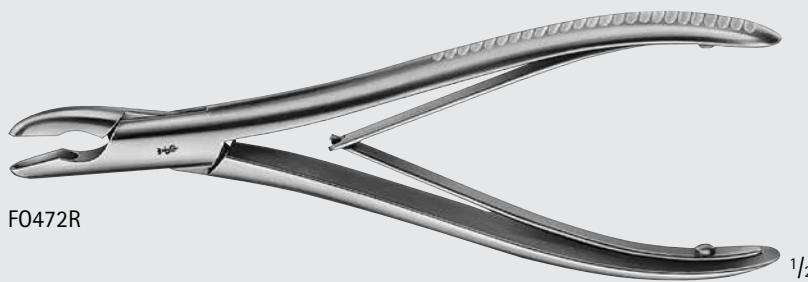

FO472R



FO472R

GULEKE Bone Rongeur

Catalog Number	Jaw Size (mm)	Jaw	Length (in.)
FO472R	6.5 x 27	CVD	8



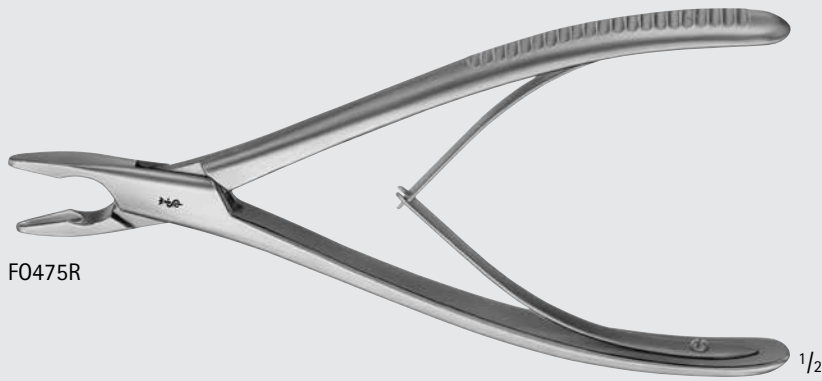

FO475R

1/2



1/1

FO475R

PENNYBACKER Bone Rongeur

Catalog Number	Jaw Size (mm)	Jaw	Length (in.)
FO475R	4.0 x 26	STR	8

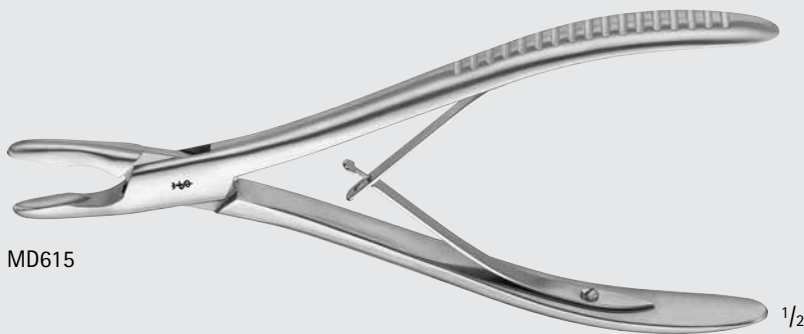

MD615

1/2



1/1

MD615

ADSON Cranial Rongeur

Catalog Number	Jaw Size (mm)	Jaw	Length (in.)
MD615	21.0 x 31.5	STR	7 7/8



MG060R

1/2



1/1

MG060R

KLEINERT-KUTZ Rongeur, Double Action

Catalog Number	Jaw Size (mm)	Jaw	Length (in.)
MG060R	3.0 x 15.0	SLIGHT, CVD	6 1/8



ORTHO
SPINE

INCHES

Orthopedics/Spine

Rongeurs

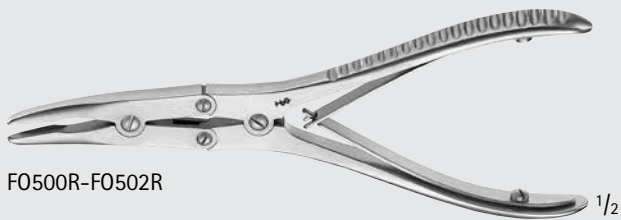

FO500R-FO502R



FO500R



FO502R

BOEHLER Bone Rongeur, Double Action

Catalog Number	Jaw Size (mm)	Jaw	Jaw End	Length (in.)
FO500R	3.0 x 27.0	CVD	NARR	6 1/8
FO502R	3.5 x 30.0	CVD	WIDE	6 1/8

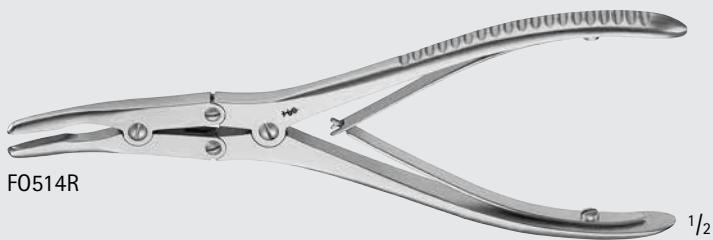

FO514R

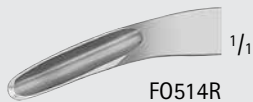

FO514R

BEYER Bone Rongeur, Double Action

Catalog Number	Jaw Size (mm)	Jaw	Length (in.)
FO514R	4.0 x 30.0	CVD	7



FO511R

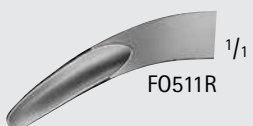

FO511R

MAYFIELD Bone Rongeur, Double Action

Catalog Number	Jaw Size (mm)	Jaw	Length (in.)
FO511R	3.5 x 23	CVD	6 7/8



FO515R



FO515R

ZAUFAL-JANSEN Bone Rongeur, Double Action

Catalog Number	Jaw Size (mm)	Jaw	Length (in.)
FO515R	4.5 x 29.0	CVD	7

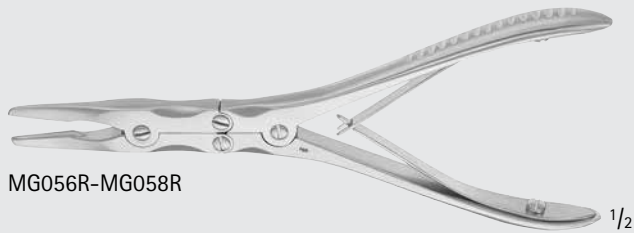

MG056R-MG058R

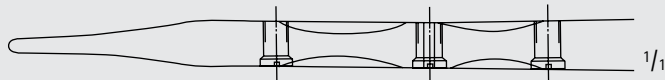

MG056R

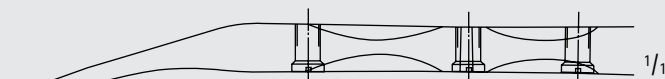

MG057R

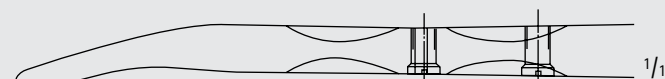

MG058R



MG579R, FO518R

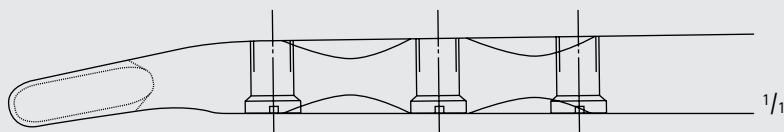

MG579R, FO518R

RUSKIN Bone Rongeur, Double Action

Catalog Number	Jaw Size (mm)	Jaw	Length (in.)
MG056R	2	STR, MINI	6 1/4
MG057R	2	CVD, MINI	6 1/4
MG058R	3	CVD, MINI	6 1/4
FO518R	5	CVD	7 1/2
MG579R	6	CVD	7 1/4



INCHES

Orthopedics/Spine

Rongeurs

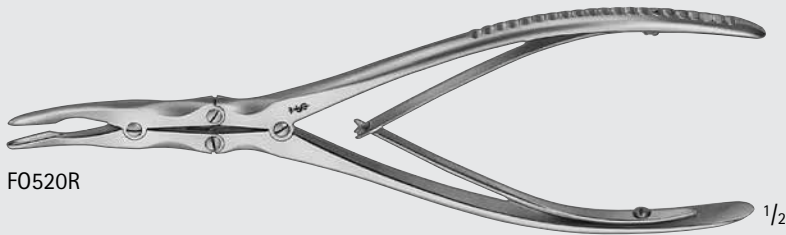

F0520R

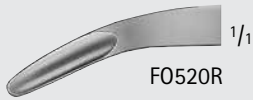

F0520R

MARQUARDT Bone Rongeur, Double Action

Catalog Number	Jaw Size (mm)	Jaw	Length (in.)
F0520R	3.5 x 15.5	CVD	7 7/8

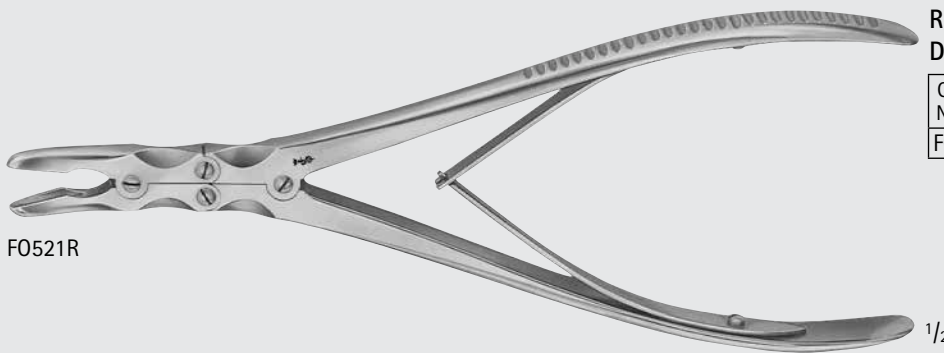

F0521R



F0521R

ROETTGEN-RUSKIN Bone Rongeur, Double Action

Catalog Number	Jaw Size (mm)	Jaw	Length (in.)
F0521R	6.3 x 30	CVD	9 1/2



MG577R



MG577R

SMITH-PETERSON Rongeur

Catalog Number	Jaw Size (mm)	Jaw	Length (in.)
MG577R	3	STR	9 1/2



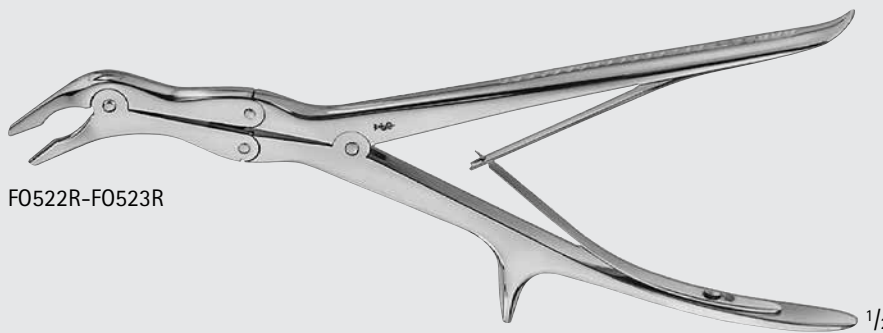

F0522R-F0523R



F0522R

F0523R

ECHLIN Bone Rongeur, Double Action, Duckbill

Catalog Number	Jaw Size (mm)	Jaw	Length (in.)
F0522R	2 x 10	ANG	9
F0523R	3 x 10	ANG	9

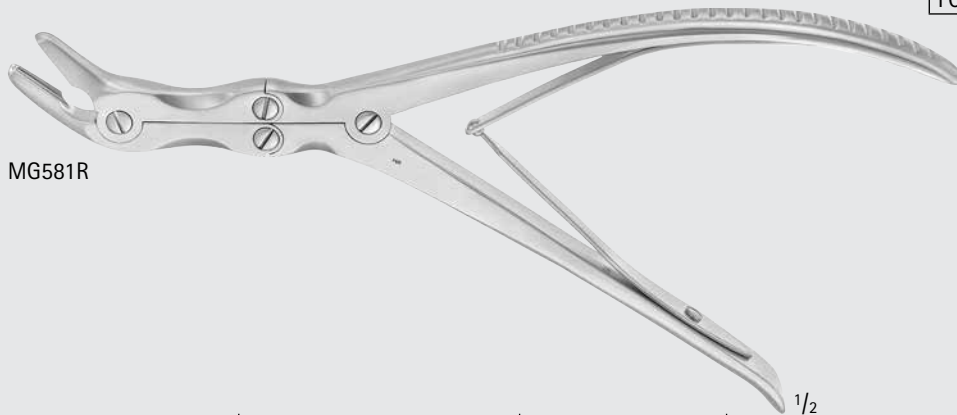

MG581R

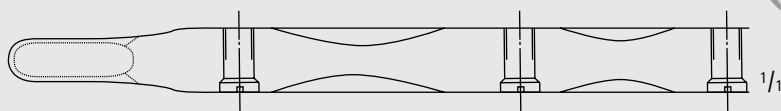

MG581R



F0526R-F0527R

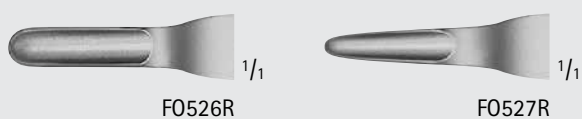

F0526R

F0527R

LEKSELL Bone Rongeur, Double Action, Duckbill

Catalog Number	Jaw Size (mm)	Jaw	Length (in.)
MG581R	5	FULL CVD	9
F0526R	5 x 16	ANG	9 5/8
F0527R	3 x 16	ANG	9 5/8



ORTHO
SPINE

INCHES

Orthopedics/Spine

Rongeurs

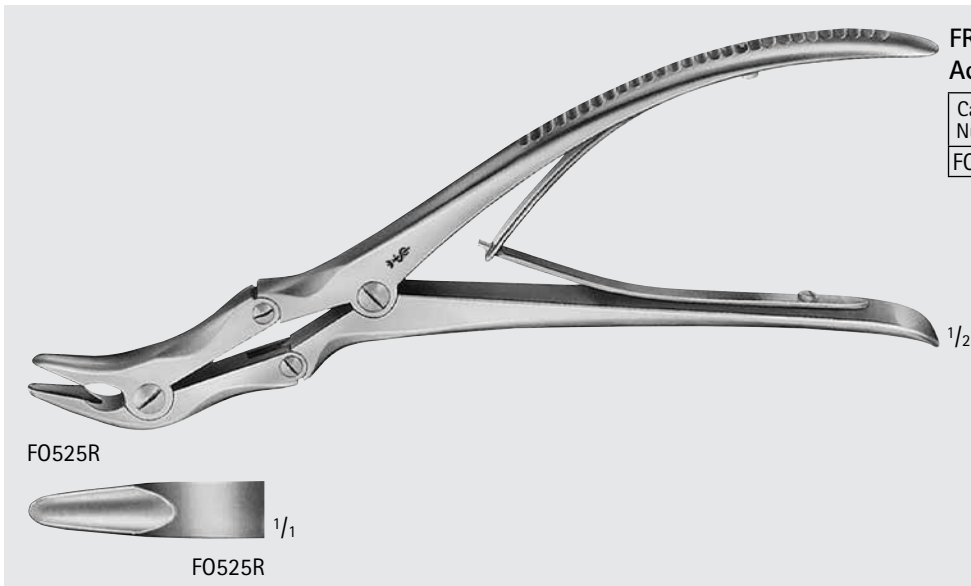

FRYKHOLM Bone Rongeur, Double Action

Catalog Number	Jaw Size (mm)	Jaw	Length (in.)
F0525R	4.5 x 25	ANG	9 1/2

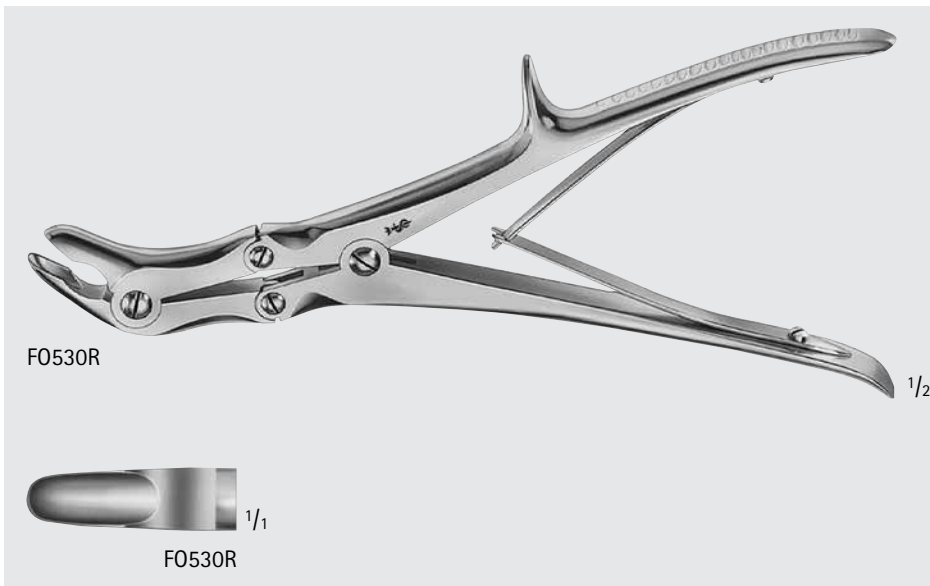

STILLE Bone Rongeur, Double Action, Duckbill

Catalog Number	Jaw Size (mm)	Jaw	Length (in.)
F0530R	7.0 x 25	ANG	9

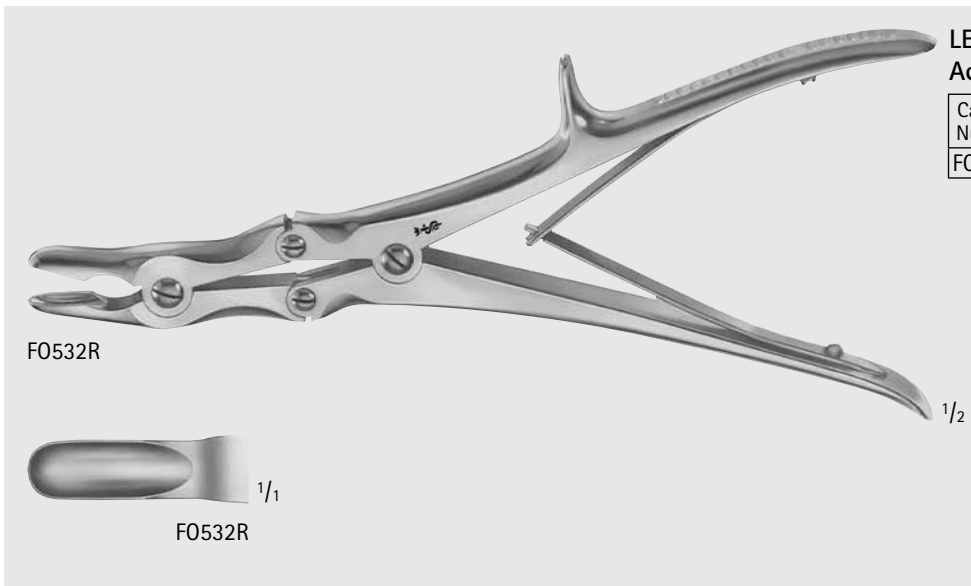

LEKSELL-STILLE Bone Rongeur, Double Action, Duckbill

Catalog Number	Jaw Size (mm)	Jaw	Length (in.)
F0532R	7.5 x 29.5	ANG	9 1/2

SYPERT Bone Rongeur, Double Action

Catalog Number	Jaw Size (mm)	Jaw	Length (in.)
FG052R	8.0 x 35.0	ANG	14 1/4

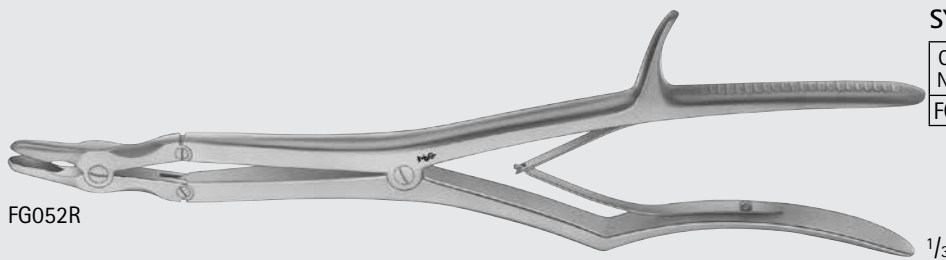

FG052R

1/3



1/1

FG052R

STILLE-RUSKIN Bone Rongeur, Double Action

Catalog Number	Jaw Size (mm)	Jaw	Length (in.)
F0534R	8.0 x 34.0	CVD	9 1/2

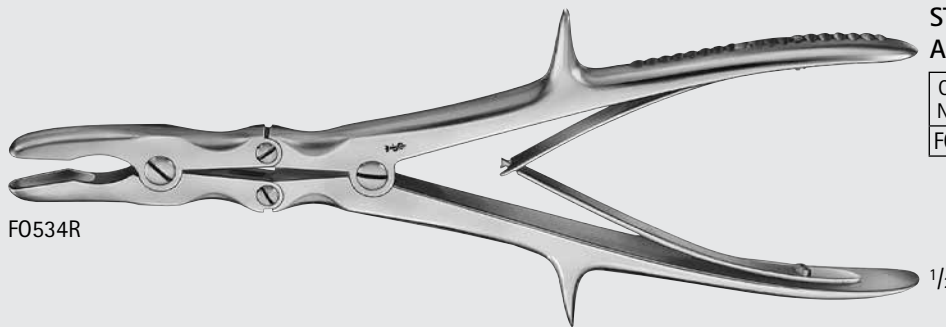

F0534R

1/2



1/1

F0534R

SAUERBRUCH-CORYLLOS Rongeur, Double Action

Catalog Number	Length (in.)
F0570R	12 1/4
F0572R	12 1/4



F0570R-F0572R

1/3



1/1

F0570R

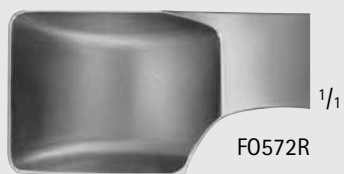

1/1

F0572R



ORTHO
SPINE

INCHES

Orthopedics/Spine

Rongeurs

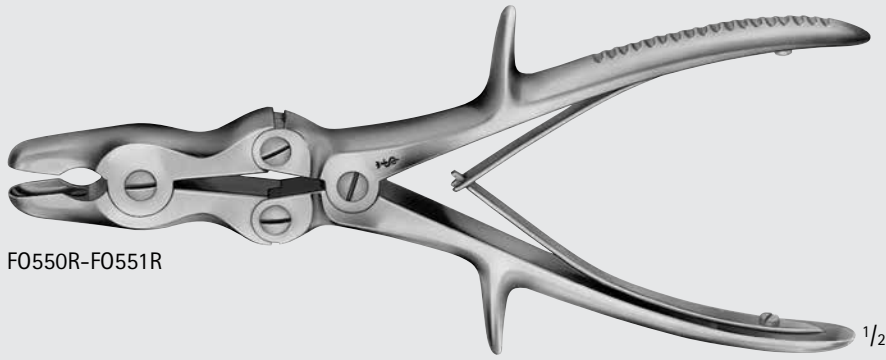

F0550R-F0551R

LUER-STILLE Bone Rongeur, Double Action

Catalog Number	Jaw Size (mm)	Jaw	Length (in.)
F0550R	10.5 x 27.5	STR	8 7/8
F0551R	10 x 26.5	CVD	8 7/8



F0550R



F0551R

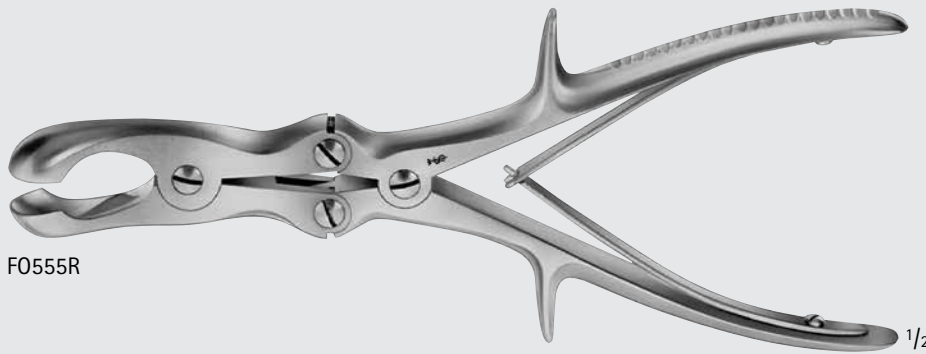

F0555R

SEMB Bone Rongeur, Double Action

Catalog Number	Jaw Size (mm)	Jaw	Length (in.)
F0555R	16.5 x 38.5	CVD	9 1/2

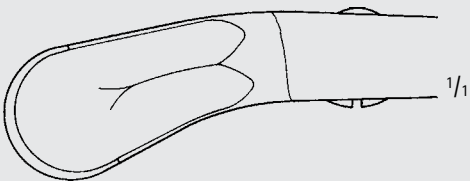

F0555R

ORTHO SPINE
 MILLIMETERS

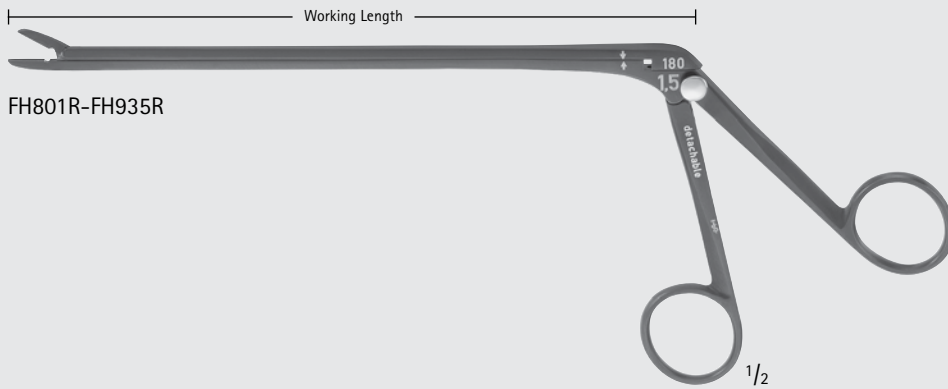

FH801R-FH935R



Noir Detachable Rongeurs

Working Length (in.)	Jaw	Jaw	1.5 mm	2.0 mm	3.0 mm	4.0 mm	5.0 mm
6		STR	FH801B	FH802B	FH803B	FH804B	FH805B
6		UP	FH901B	FH902B	FH903B	FH904B	FH905B
7		STR	FH811B	FH812B	FH813B	FH814B	FH815B
7		UP	FH911B	FH912B	FH913B	FH914B	FH915B
7 7/8		STR	FH821B	FH822B	FH823B	FH824B	FH825B
7 7/8		UP	FH921B	FH922B	FH923B	FH924B	FH925B
9		STR	FH891B	FH892B	FH893B	FH894B	FH895B
9		UP	FH931B	FH932B	FH933B	FH934B	FH935B
11		STR	-	-	FH837B	FH838B	FH839B



ORTHO
SPINE

INCHES

Orthopedics/Spine

Noir™ Rongeurs



Noir Detachable Rongeur

Working Length (in.)	Jaw	Jaw	1.5 mm	2.0 mm	3.0 mm	4.0 mm	5.0 mm
6		STR	FH851B	FH852B	FH853B	FH854B	FH855B
7		UP	FH951B	FH952B	FH953B	FH954B	FH955B
7		STR	FH861B	FH862B	FH863B	FH864B	FH865B
7		UP	FH961B	FH962B	FH963B	FH964B	FH965B
7 7/8		STR	FH871B	FH872B	FH873B	FH874B	FH875B
7 7/8		UP	FH971B	FH972B	FH973B	FH974B	FH975B
9		STR	FH881B	FH882B	FH883B	FH884B	FH885B
9		UP	FH981B	FH982B	FH983B	FH984B	FH985B
11		STR	-	-	FH847B	FH848B	FH849B



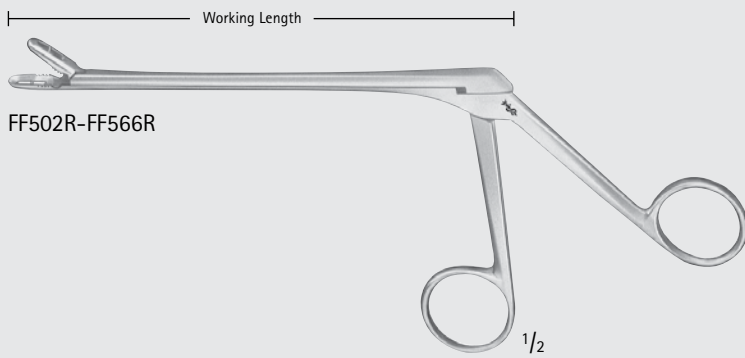



FF502R-FF566R

 1/1
FF502R, FF532R, FF562R

 1/1
FF503R, FF533R, FF563R

 1/1
FF504R, FF534R, FF564R

 1/1
FF535R, FF565R

 1/1
FF536R, FF566R

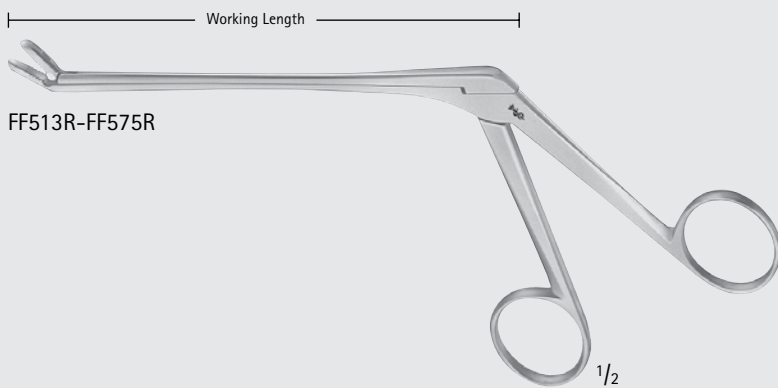

FF513R-FF575R

 1/1
FF513R, FF543R, FF573R

 1/1
FF514R, FF544R, FF574R

 1/1
FF545R, FF575R

CASPAR Rongeur W/ Teeth

Catalog Number	Jaw Size (mm)	Jaw	Working Length (in.)
FF502R	2 x 12	STR	5 1/2
FF532R	2 x 12	STR	6 1/4
FF562R	2 x 12	STR	7 1/4
FF503R	3 x 12	STR	5 1/2
FF533R	3 x 12	STR	6 1/4
FF563R	3 x 12	STR	7 1/4
FF504R	4 x 14	STR	5 1/2
FF534R	4 x 14	STR	6 1/4
FF564R	4 x 14	STR	7 1/4
FF535R	5 x 14	STR	6 1/4
FF565R	5 x 14	STR	7 1/4
FF536R	6 x 16	STR	6 1/4
FF566R	6 x 16	STR	7 1/4
FF513R	3 x 12	UP	5 1/2
FF543R	3 x 12	UP	6 1/4
FF573R	3 x 12	UP	7 1/4
FF514R	4 x 14	UP	5 1/2
FF544R	4 x 14	UP	6 1/4
FF574R	4 x 14	UP	7 1/4
FF545R	5 x 14	UP	6 1/4
FF575R	5 x 14	UP	7 1/4



INCHES

Orthopedics/Spine

Rongeurs

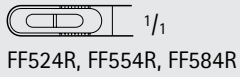
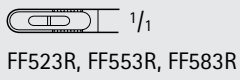
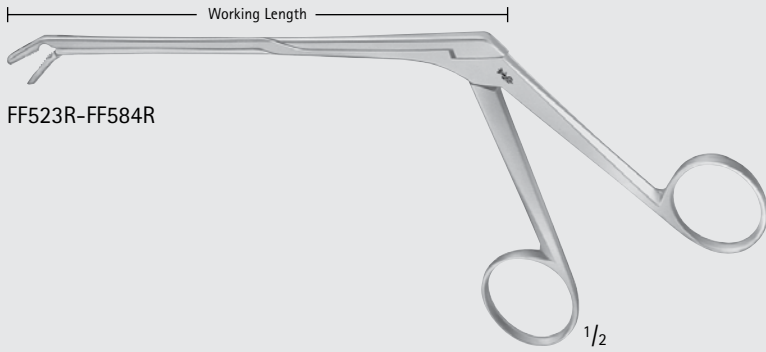

CASPAR Rongeur W/ Teeth (continued)

Catalog Number	Jaw Size (mm)	Jaw	Working Length (in.)
FF523R	3 x 12	DOWN	5 1/2
FF553R	3 x 12	DOWN	6 1/4
FF583R	3 x 12	DOWN	7 1/4
FF524R	4 x 14	DOWN	5 1/2
FF554R	4 x 14	DOWN	6 1/4
FF584R	4 x 14	DOWN	7 1/4

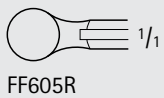
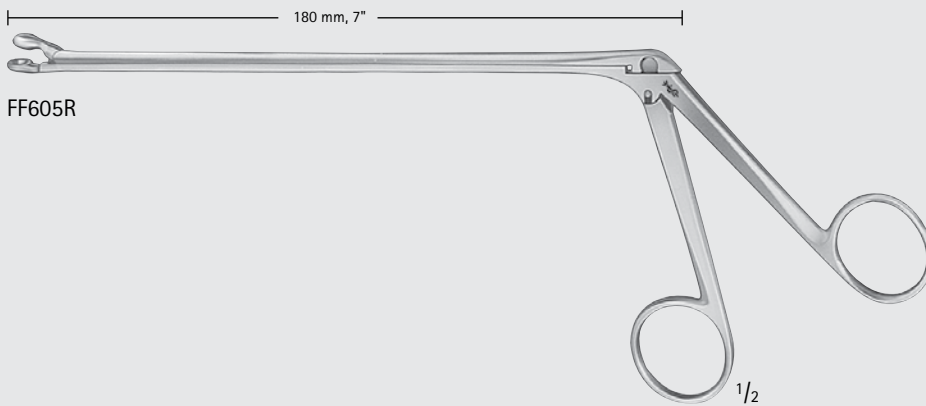

OLDBERG Rongeur

Catalog Number	Diameter (mm)	Working Length (in.)
FF605R	7.0	7



195 mm, 7 1/2"

FF599R-FF600R

1/16

FF599R

1/16

FF600R

1/2

YASARGIL Rongeur

Catalog Number	Diameter (mm)	Working Length (in.)
FF599R	2.2	7 1/2
FF600R	3.5	7 1/2

140 mm, 5 1/2"

FF765R

1/16

FF765R

1/2

BECK Rongeur

Catalog Number	Jaw Size (mm)	Working Length (in.)
FF765R	2 x 10	5 1/8

210 mm, 8 1/4"

FF808R

1/16

FF808R

1/2

WAGNER Rongeur

Catalog Number	Jaw Size (mm)	Working Length (in.)
FF808R	5.5	8 1/4



ORTHO
SPINE

INCHES

Orthopedics/Spine

Rongeurs

CUSHING Rongeur

Catalog Number	Jaw Size (mm)	Jaw	Style	Working Length (in.)
MD537R	1.5 x 10	STR	STANDARD	7
MN090R	1.5 x 10	STR	DELICATE	9
FF803R	2 x 10	STR	-	7
MN093R	2 x 10	STR	STANDARD	9
MN096R	2 x 10	STR	STANDARD	11
MN099R	2 x 10	STR	STANDARD	12
MD538R	1.5 x 10	UP	STANDARD	7
MD618	2 x 10	UP	-	7
MN091R	1.5 x 10	UP	DELICATE	9
MN094R	2 x 10	UP	STANDARD	9
MN097R	2 x 10	UP	STANDARD	11
MN100R	2 x 10	UP	STANDARD	12
MD539R	1.5 x 10	DOWN	STANDARD	7
MN092R	1.5 x 10	DOWN	DELICATE	9
MD619	2 x 10	DOWN	-	7
MN095R	2 x 10	DOWN	STANDARD	9
MN098R	2 x 10	DOWN	STANDARD	11
MN101R	2 x 10	DOWN	STANDARD	12

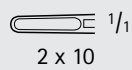
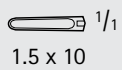
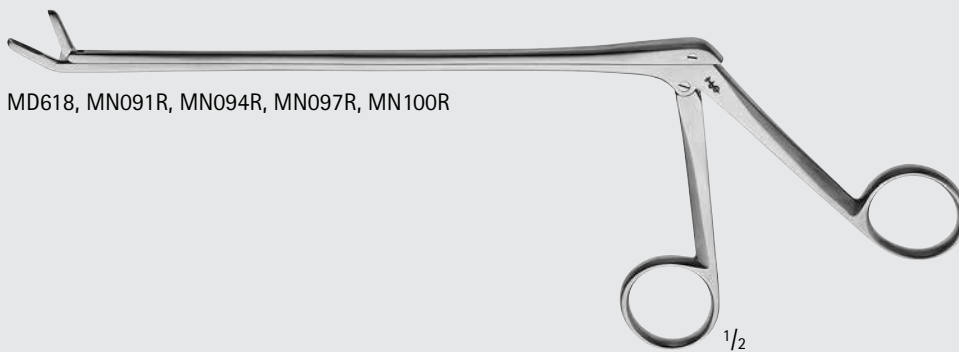
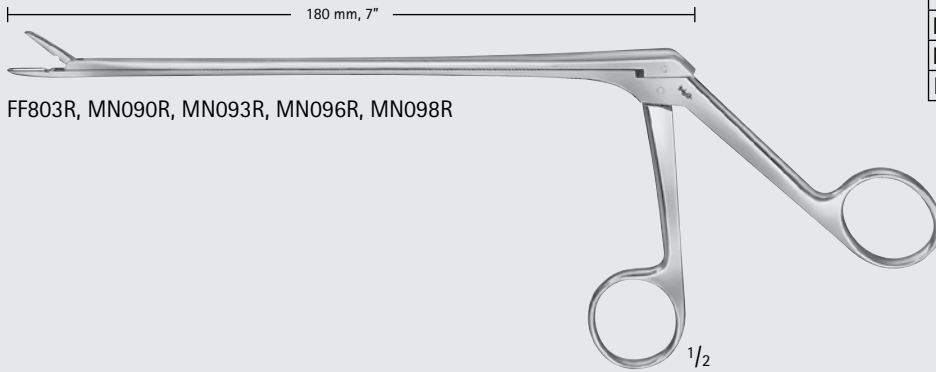

LOVE-GRUENWALD Rongeur

Catalog Number	Jaw Size (mm)	Jaw	Working Length (in.)
FF805R	3 x 10	STR	7
MN102R	3 x 10	STR	9
MN105R	3 x 10	STR	11
MN108R	3 x 10	STR	12
MF446R	2 x 10	UP	5
FF806R	3 x 10	UP	7
MN103R	3 x 10	UP	9
MN106R	3 x 10	UP	11
MN109R	3 x 10	UP	12
MF447R	2 x 10	DOWN	5
FF810R	3 x 10	DOWN	7
MN104R	3 x 10	DOWN	9
MN107R	3 x 10	DOWN	11
MN110R	3 x 10	DOWN	12

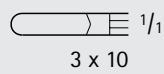
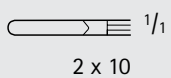
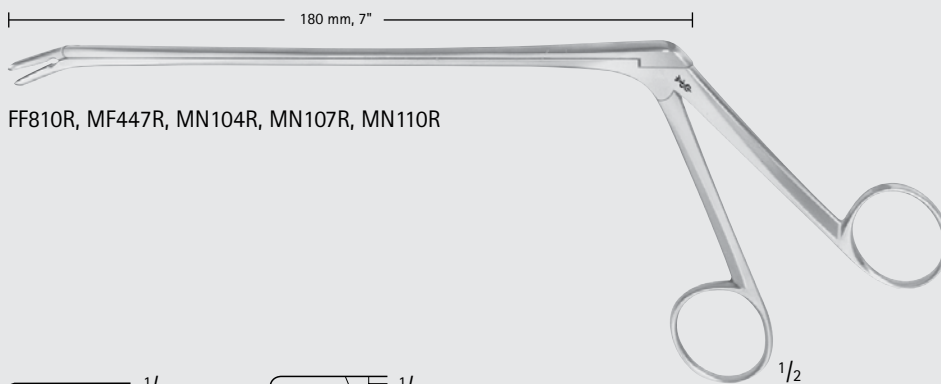
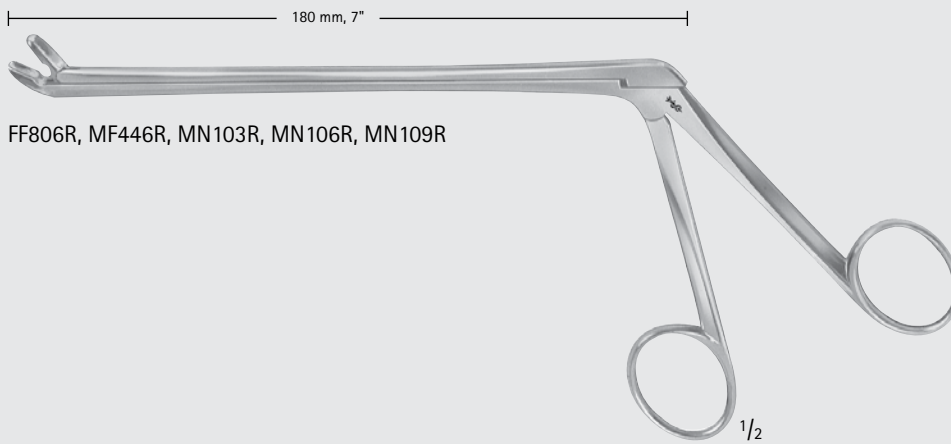
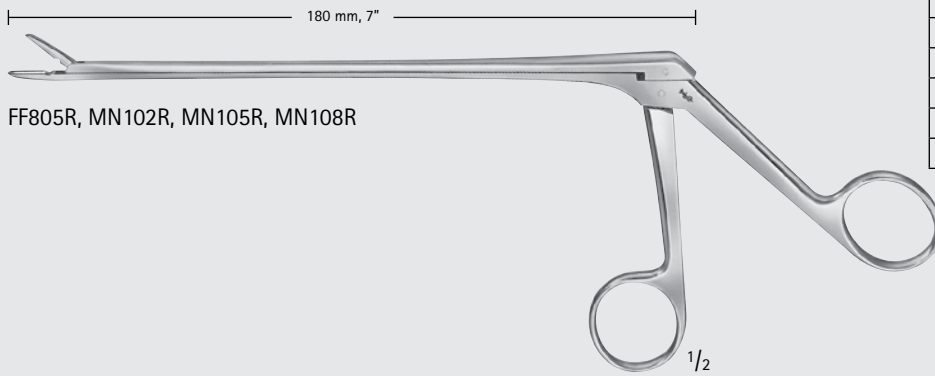

Orthopedics/Spine

Rongeurs

SPURLING Rongeur

Catalog Number	Jaw Size (mm)	Jaw	Working Length (in.)
FF807R	4 x 10	STR	7
MN111R	4 x 10	STR	9
MN114R	4 x 10	STR	11
MN117R	4 x 10	STR	12
FF814R	4 x 10	UP	7
MN112R	4 x 10	UP	9
MN115R	4 x 10	UP	11
MN118R	4 x 10	UP	12
FF811R	4 x 10	DOWN	7
MN113R	4 x 10	DOWN	9
MN116R	4 x 10	DOWN	11
MN119R	4 x 10	DOWN	12

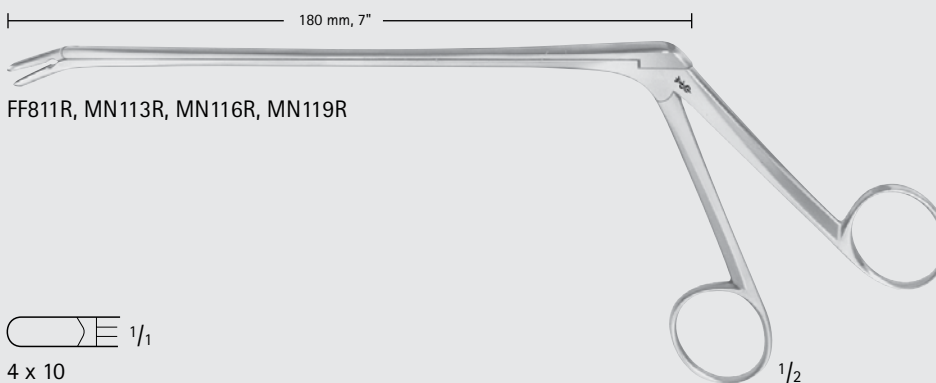
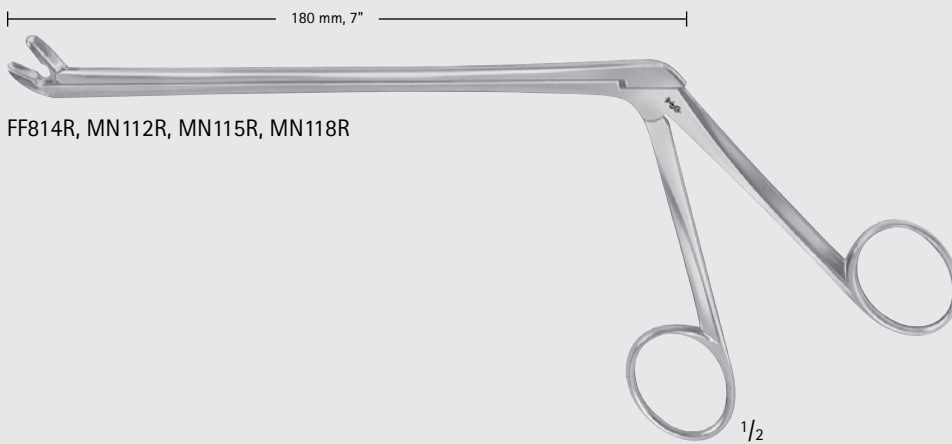
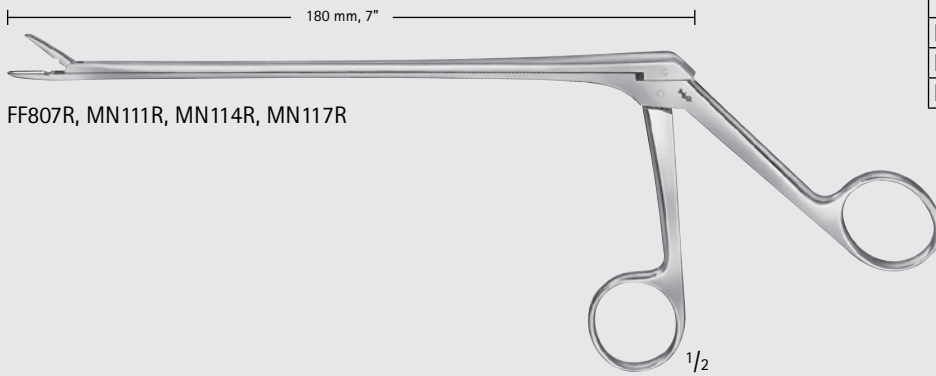

IVD Rongeur

Catalog Number	Jaw Size (mm)	Jaw	Working Length (in.)
MN120R	5 x 10	STR	9
MN123R	5 x 10	STR	11
MN126R	5 x 10	STR	12
MN121R	5 x 10	UP	9
MN124R	5 x 10	UP	11
MN127R	5 x 10	UP	12
MN122R	5 x 10	DOWN	9
MN125R	5 x 10	DOWN	11
MN128R	5 x 10	DOWN	12

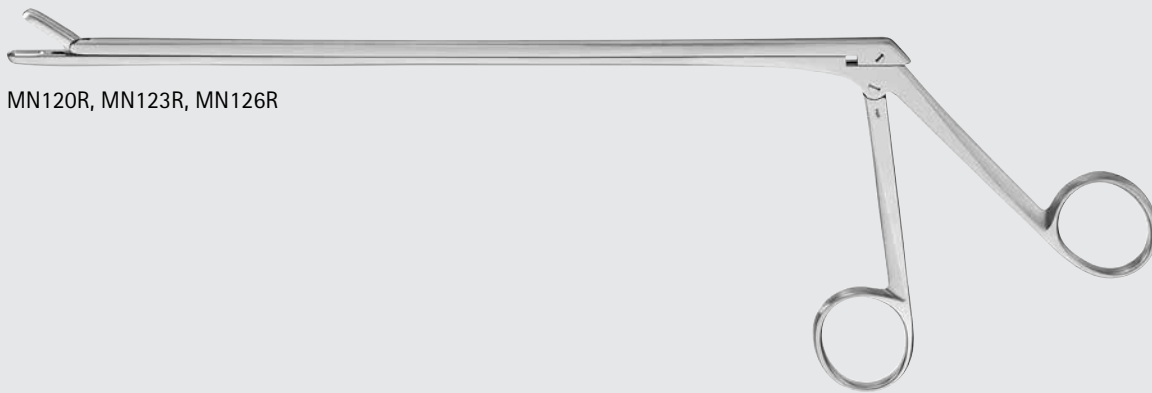

MN120R, MN123R, MN126R



MN121R, MN124R, MN127R



MN122R, MN125R, MN128R

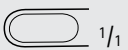

MN120R, MN123R, MN126R

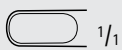

MN121R, MN124R, MN127R

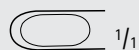

MN122R, MN125R, MN128R



INCHES

Orthopedics/Spine

Rongeurs

WAGNER Rongeur

Catalog Number	Jaw Size (mm)	Working Length (in.)
FF818R	5.5	7 7/8

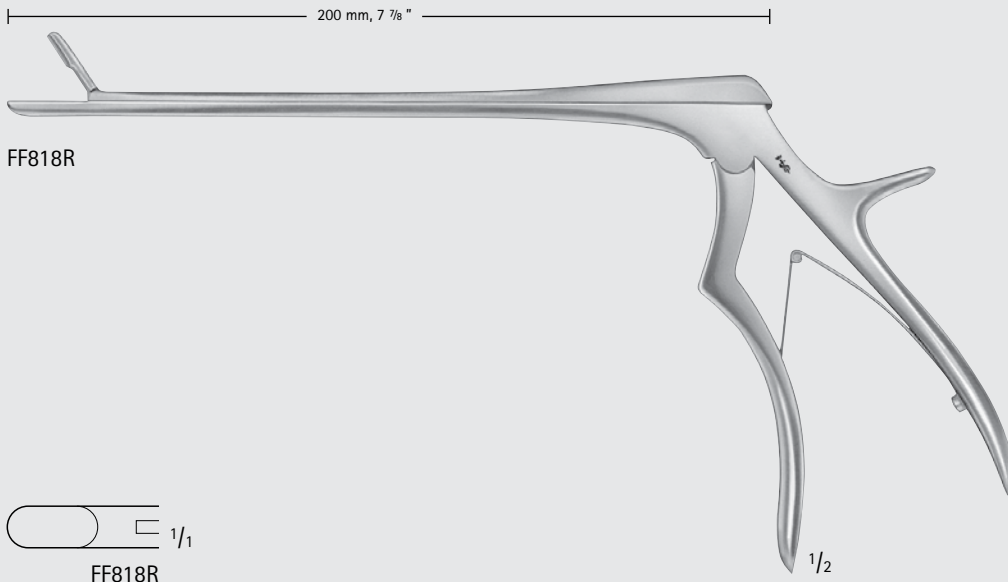

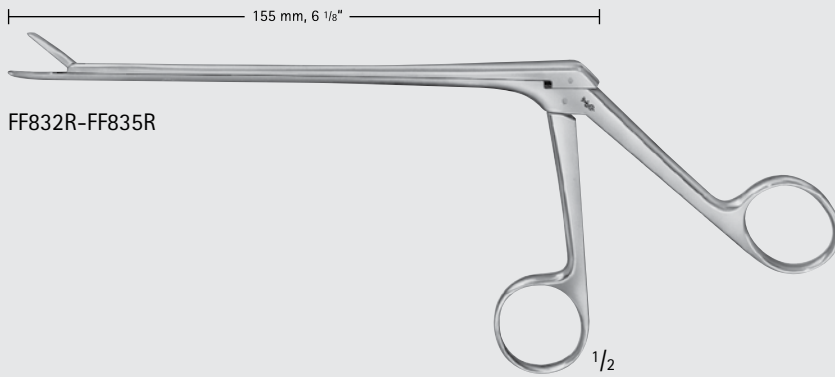

FF832R-FF835R

CASPAR Rongeur

Catalog Number	Jaw Size (mm)	Jaw	Working Length (in.)
FF832R	2.0	STR	6 1/8
FF833R	3.0	STR	6 1/8
FF834R	4.0	STR	6 1/8
FF835R	5.0	STR	6 1/8
FF842R	2.0	UP	6 1/8
FF843R	3.0	UP	6 1/8
FF844R	4.0	UP	6 1/8
FF852R	2.0	DOWN	6 1/8
FF853R	3.0	DOWN	6 1/8
FF854R	4.0	DOWN	6 1/8

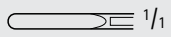

FF832R, FF842R, FF852R

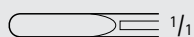

FF833R, FF843R, FF853R

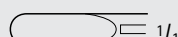

FF834R, FF844R, FF854R

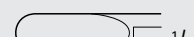

FF835R

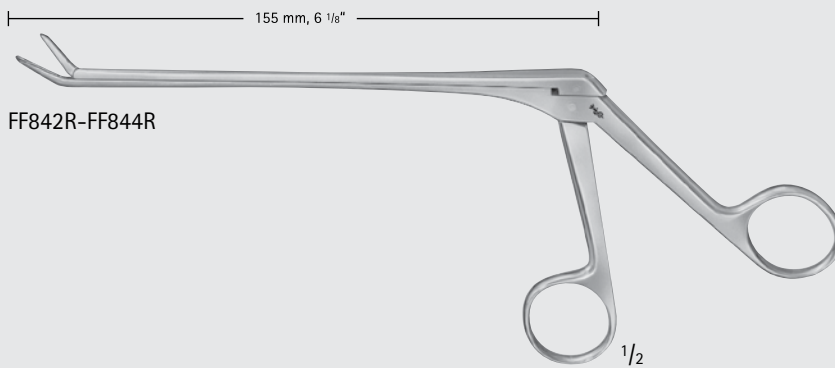

FF842R-FF844R

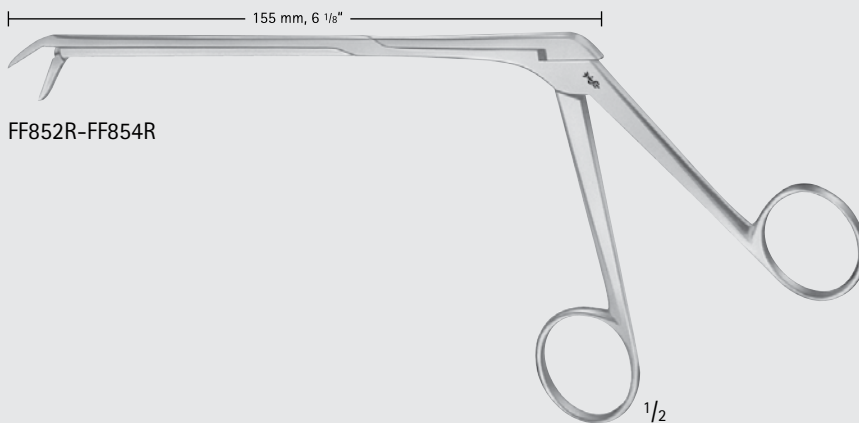

FF852R-FF854R



INCHES

Orthopedics/Spine

Rongeurs



180 mm, 7"

FF856R-FF857R

FF856R 1/1

FF857R 1/1

1/2

CASPAR Heavy Rongeur, F/ Removal of Hard Disc Pathology

Catalog Number	Jaw Size (mm)	Jaw	Working Length (in.)
FF856R	3.0	STR	7
FF857R	4.0	STR	7

260 mm, 10 1/4"

FG057R

FG057R 1/1

1/2

SYPERT Rongeur

Catalog Number	Jaw Size (mm)	Jaw	Working Length (in.)
FG057R	5 x 20	UP	10 1/4

150 mm, 6"

F0820R

F0820R 1/1

1/2

KRAEMER Grasping Forceps, W/ Catch

Catalog Number	Working Length (in.)
F0820R	6

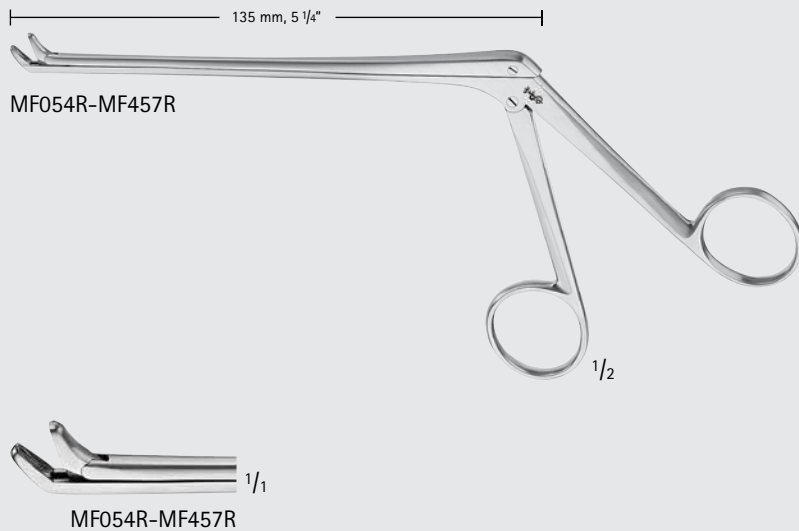

PEAPOD Disc Rongeur

Catalog Number	Jaw Size (mm)	Jaw	Working Length (in.)
MF054R	2 x 6	UP	5 1/2
MF456R	3 x 6	UP	5 1/4
MF457R	4 x 6	UP	5 1/4

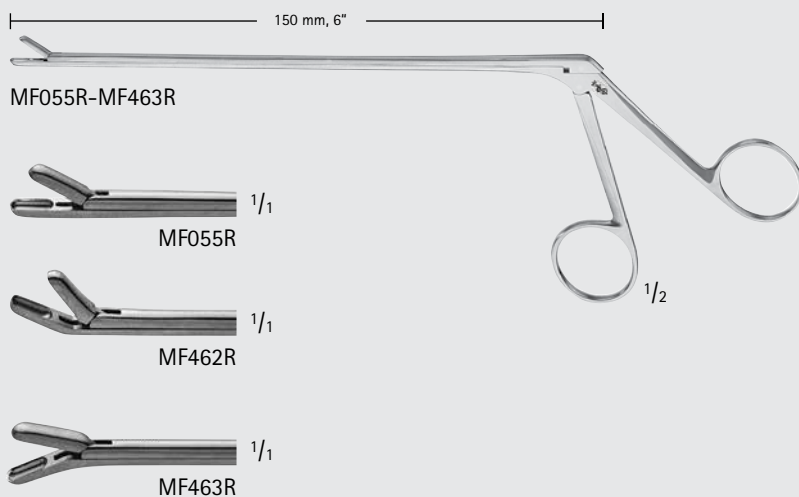

DECKER Rongeur

Catalog Number	Jaw Size (mm)	Jaw	Working Length (in.)
MF055R	2 x 6	STR	6
MF462R	2 x 6	UP	6
MF463R	2 x 6	DOWN	6

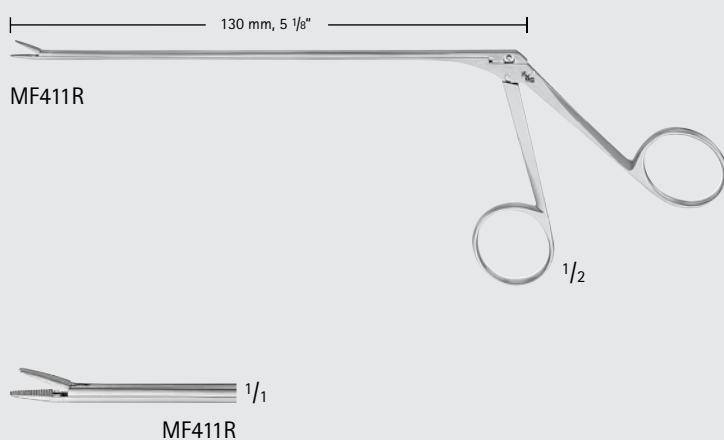

STEVENSON Grasping Forceps

Catalog Number	Jaw Size (mm)	Jaw	Working Length (in.)
MF411R	6.0	STR	5 1/8



ORTHO
SPINE

INCHES

Orthopedics/Spine

Rongeurs

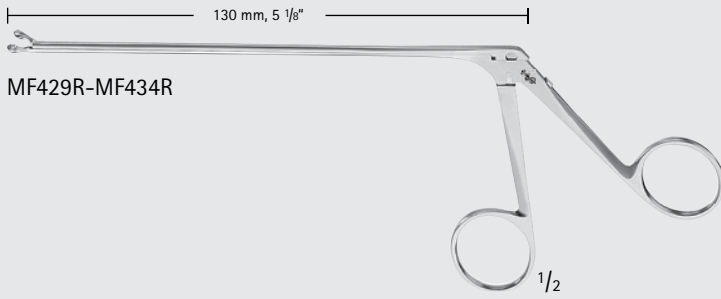

MF429R-MF434R



MF429R-MF434R

Rhoton Style Cup Forceps

Catalog Number	Jaw Size (mm)	Jaw	Working Length (in.)
MF429R	0.5	STR	5 1/8
MF432R	1.0	STR	5 1/8
MF435R	2.0	STR	5 1/8
MF436R	3.0	STR	5 1/8
MF437R	4.0	STR	5 1/8
MF438R	5.0	STR	5 1/8
MF430R	0.5	RIGHT	5 1/8
MF433R	1.0	RIGHT	5 1/8
MF431R	0.5	LEFT	5 1/8
MF434R	1.0	LEFT	5 1/8

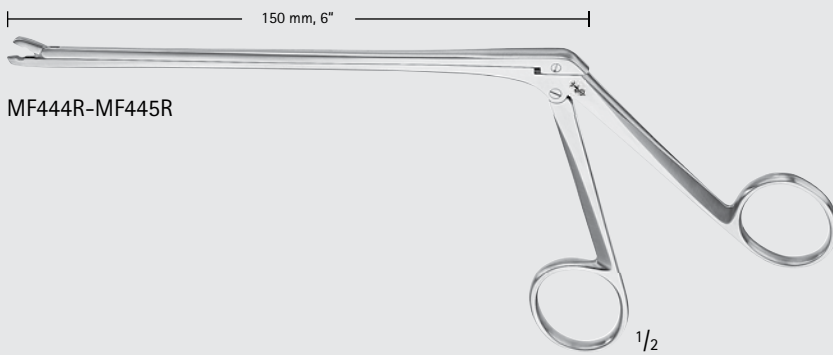

MF444R-MF445R



MF444R-MF445R

SELVERSTONE Rongeur

Catalog Number	Jaw Size (mm)	Jaw	Working Length (in.)
MF444R	2 x 3	STR	6
MF445R	2 x 5	STR	6

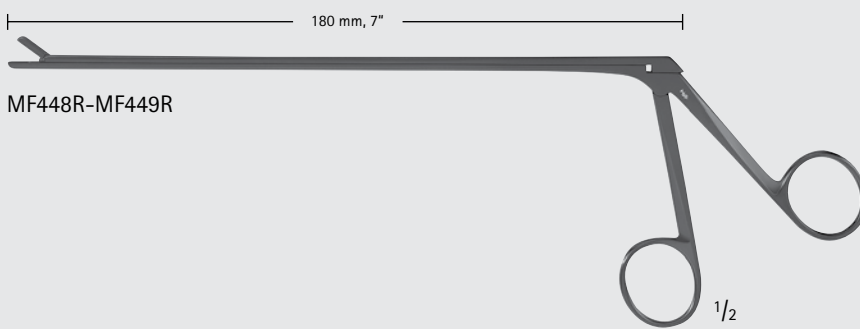

MF448R-MF449R

Black Coated Micro Pituitary Rongeur

Catalog Number	Jaw Size (mm)	Jaw	Working Length (in.)
MF448R	2 x 6	STR	7
MF449R	2 x 6	UP	7



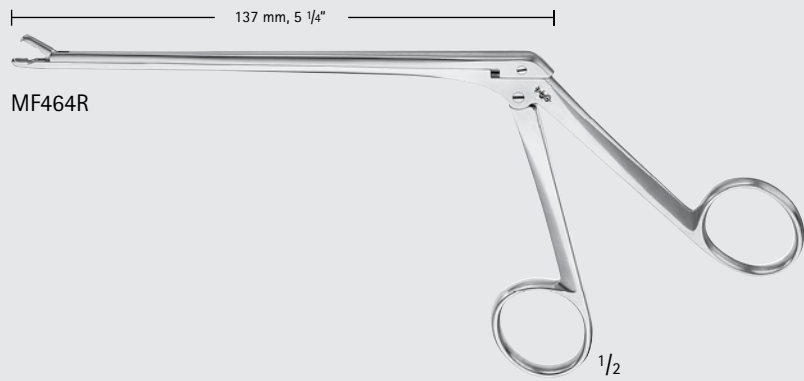

MF464R



MF464R

WILLIAMS Discectomy Forceps

Catalog Number	Jaw Size (mm)	Jaw	Working Length (in.)
MF464R	2 x 6	STR	5 1/4

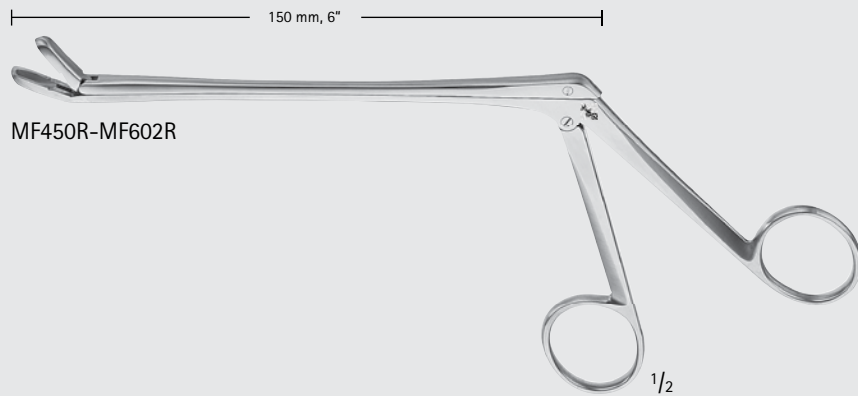

MF450R-MF602R



MF450R-MF602R

CLOWARD Style Rongeur

Catalog Number	Jaw Size (mm)	Jaw	Working Length (in.)
MF450R	6 x 10	STR	5 1/4
MF600R	6 x 10	STR	6
MF451R	6 x 10	UP	5 1/4
MF601R	6 x 10	UP	6
MF452R	6 x 10	DOWN	5 1/4
MF602R	6 x 10	DOWN	6



ORTHO
SPINE

Orthopedics/Spine

Kerrison Bone Punches

SYPERT Kerrison Bone Punch

Catalog Number	Jaw Size (mm)	Tip	Working Length (in.)
FG055R	5.5	40° UP	9 3/4

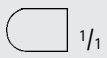
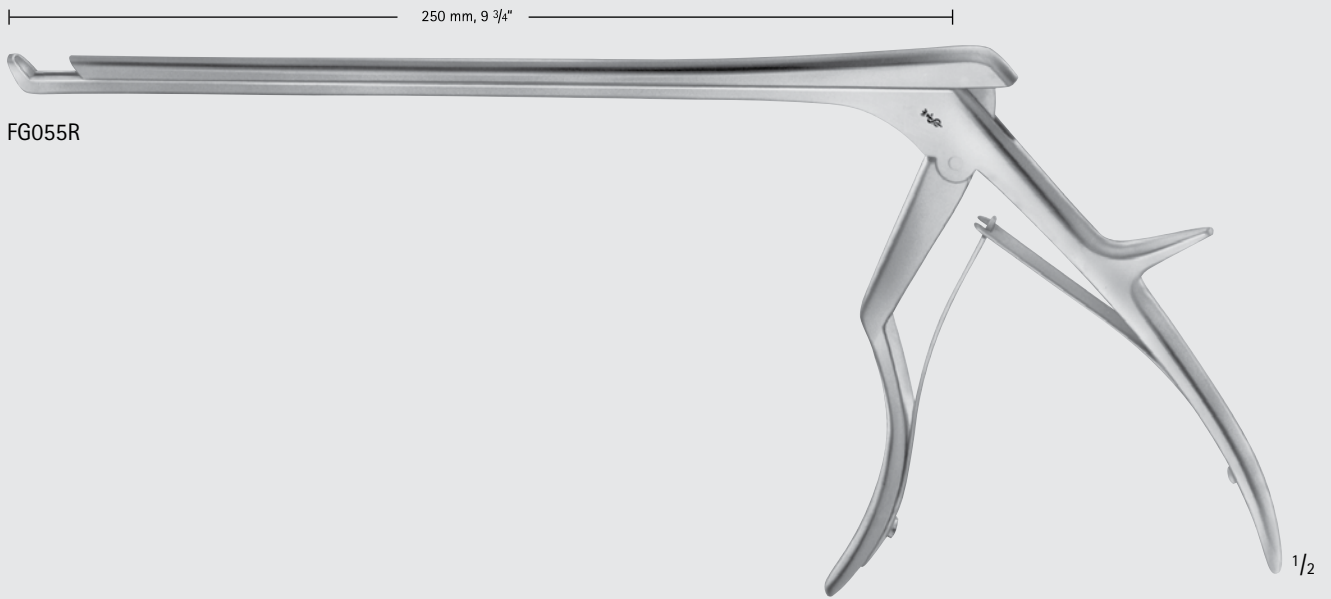

FG055R



ORTHO
SPINE

Three Primary Styles

- Non Detachable, silver
- Detachable, silver
- Detachable, ceramic NOIR coating

For more information see our brochure DOC400.

Complete Size and Footplate Range

- Regular and thin footplates
- 7", 8", 9", 11" lengths
- 1-6 mm bite sizes
- 15 mm Laminectomy jaw length
- 40° and 90° up and down jaw positions



STANDARD

Working Length (in.)	Jaw Size (mm)	Footplate	Non Detachable, Silver	Ejector	Detachable, Silver	Ejector	Detachable, NOIR Coating	Ejector
7	1.0	STANDARD	FF715R	-	FK900R	-	FK900B	-
7	1.5	STANDARD	FF638R	-	FK911R	-	FK911B	-
7	2.0	STANDARD	FF717R	-	FK901R	✓	FK901B	✓
7	2.5	STANDARD	FF639R	-	FK912R	✓	FK912B	✓
7	3.0	STANDARD	FF720R	-	FK902R	✓	FK902B	✓
7	4.0	STANDARD	FF724R	-	FK903R	✓	FK903B	✓
7	5.0	STANDARD	FF722R	-	FK904R	✓	FK904B	✓
7	6.0	STANDARD	FF726R	-	FK905R	✓	FK905B	✓

7 7/8	1.0	STANDARD	FF691R	-	FK960R	-	FK960B	-
7 7/8	1.5	STANDARD	FF649R	-	FK966R	-	FK966B	-
7 7/8	2.0	STANDARD	FF737R	-	FK913R	✓	FK913B	✓
7 7/8	2.5	STANDARD	FF657R	-	FK967R	✓	FK967B	✓
7 7/8	3.0	STANDARD	FF738R	-	FK914R	✓	FK914B	✓
7 7/8	4.0	STANDARD	FF727R	-	FK915R	✓	FK915B	✓
7 7/8	5.0	STANDARD	FF728R	-	FK916R	✓	FK916B	✓
7 7/8	6.0	STANDARD	FF729R	-	FK917R	✓	FK917B	✓

9	1.0	STANDARD	FF674R	-	FK918R	-	FK918B	-
9	2.0	STANDARD	FF682R	-	FK919R	✓	FK919B	✓
9	3.0	STANDARD	FF683R	-	FK920R	✓	FK920B	✓
9	4.0	STANDARD	FF684R	-	FK921R	✓	FK921B	✓
9	5.0	STANDARD	FF685R	-	FK922R	✓	FK922B	✓

11	1.0	STANDARD	FF696R	-	FK981R	-	FK981B	-
11	2.0	STANDARD	FF686R	-	FK986R	✓	FK986B	✓
11	3.0	STANDARD	FF687R	-	FK987R	✓	FK987B	✓
11	4.0	STANDARD	FF688R	-	FK988R	✓	FK988B	✓
11	5.0	STANDARD	FF689R	-	FK989R	✓	FK989B	✓
11	6.0	STANDARD	FF690R	-	-	-	-	-



INCHES

Orthopedics/Spine

Kerrison Bone Punches

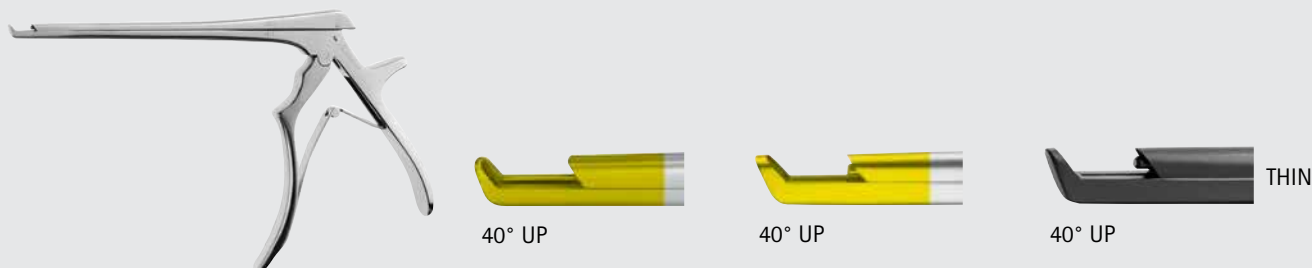

Working Length (in.)	Jaw Size (mm)	Footplate	Non Detachable, Silver	Ejector	Detachable, Silver	Ejector	Detachable, NOIR Coating	Ejector
7	1.0	THIN	FF771R	-	FK906R	-	FK906B	-
7	1.5	THIN	FF645R	-	FK923R	-	FK923B	-
7	2.0	THIN	FF772R	-	FK907R	✓	FK907B	✓
7	2.5	THIN	FF646R	-	FK924R	✓	FK924B	✓
7	3.0	THIN	FF773R	-	FK908R	✓	FK908B	✓
7	4.0	THIN	FF769R	-	FK909R	✓	FK909B	✓
7	5.0	THIN	FF770R	-	FK910R	✓	FK910B	✓
7 7/8	1.0	THIN	FF661R	-	FK961R	-	FK961B	-
7 7/8	1.5	THIN	FF658R	-	FK968R	-	FK968B	-
7 7/8	2.0	THIN	FF662R	-	FK962R	✓	FK962B	✓
7 7/8	2.5	THIN	FF659R	-	FK969R	✓	FK969B	✓
7 7/8	3.0	THIN	FF663R	-	FK963R	✓	FK963B	✓
7 7/8	4.0	THIN	FF664R	-	FK964R	✓	FK964B	✓
7 7/8	5.0	THIN	FF665R	-	FK965R	✓	FK965B	✓
9	1.0	THIN	FF734R	-	FK929R	-	FK929B	-
9	2.0	THIN	FF746R	-	FK925R	✓	FK925B	✓
9	3.0	THIN	FF747R	-	FK926R	✓	FK926B	✓
9	4.0	THIN	FF748R	-	FK927R	✓	FK927B	✓
9	5.0	THIN	FF749R	-	FK928R	✓	FK928B	✓
11	1.0	THIN	FF673R	-	FK980R	-	FK980B	-
11	2.0	THIN	FF666R	-	FK976R	✓	FK976B	✓
11	3.0	THIN	FF667R	-	FK977R	✓	FK977B	✓
11	4.0	THIN	FF668R	-	FK978R	✓	FK978B	✓
11	5.0	THIN	FF669R	-	FK979R	✓	FK979B	✓



Orthopedics/Spine

Kerrison Bone Punches, Laminectomy



40° UP



40° UP



40° UP

STANDARD

Working Length (in.)	Jaw Size (mm)	Jaw Opening (mm)	Footplate	Non Detachable, Silver	Ejector	Detachable, Silver	Ejector	Detachable, NOIR Coating	Ejector
7	2.0	15	STANDARD	FF677R	-	FK971R	✓	FK971B	✓
7	3.0	15	STANDARD	FF678R	-	FK972R	✓	FK972B	✓
7	4.0	15	STANDARD	FF679R	-	FK973R	✓	FK973B	✓
7	5.0	15	STANDARD	FF680R	-	FK974R	✓	FK974B	✓
7	6.0	15	STANDARD	-	-	FK975R	✓	FK975B	✓

7 7/8	2.0	15	STANDARD	FF660R	-	FK970R	✓	FK970B	✓
7 7/8	3.0	15	STANDARD	FF739R	-	FK982R	✓	FK982B	✓
7 7/8	4.0	15	STANDARD	FF745R	-	FK983R	✓	FK983B	✓
7 7/8	5.0	15	STANDARD	FF751R	-	FK984R	✓	FK984B	✓
7 7/8	6.0	15	STANDARD	FF753R	-	FK985R	✓	FK985B	✓



90° UP

STANDARD

Working Length (in.)	Jaw Size (mm)	Jaw Opening (mm)	Non Detachable, Silver	Ejector
7	3	15	FF136R	-
7	4	15	FF137R	-
7	5	15	FF138R	-

8	3	15	FF086R	-
8	4	15	FF087R	-
8	5	15	FF088R	-



Orthopedics/Spine

Kerrison Bone Punches

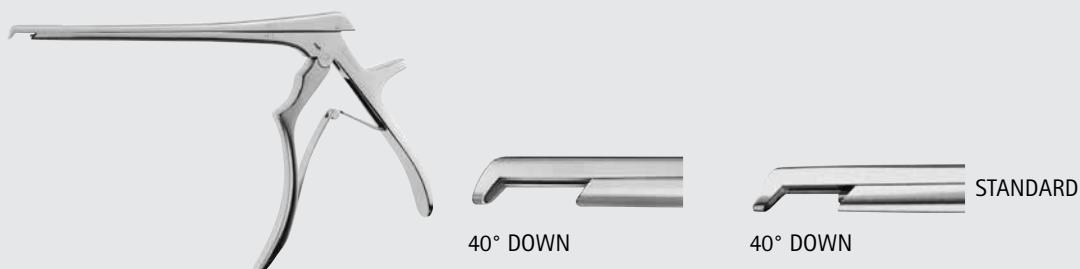

Working Length (in.)	Jaw Size (mm)	Footplate	Non Detachable, Silver	Ejector	Detachable, Silver	Ejector
7	1.0	STANDARD	FF711R	-	FK930R	-
7	2.0	STANDARD	FF712R	-	FK931R	✓
7	3.0	STANDARD	FF713R	-	FK932R	✓
7	4.0	STANDARD	FF714R	-	FK933R	✓
7	5.0	STANDARD	FF725R	-	FK934R	✓

9	2.0	STANDARD	FF692R	-	FK943R	✓
9	3.0	STANDARD	FF693R	-	FK944R	✓
9	4.0	STANDARD	FF694R	-	FK945R	✓
9	5.0	STANDARD	FF695R	-	FK946R	✓



Working Length (in.)	jaw Size (mm)	Footplate	Non Detachable, Silver	Ejector	Detachable, Silver	Ejector
7	1.0	THIN	FF781R	-	FK936R	-
7	2.0	THIN	FF782R	-	FK937R	✓
7	3.0	THIN	FF783R	-	FK938R	✓
7	4.0	THIN	FF784R	-	FK939R	✓
7	5.0	THIN	FF785R	-	FK940R	✓





Working Length (in.)	Jaw Size (mm)	Footplate	Non Detachable, Silver	Ejector	Detachable, Silver	Ejector	Detachable NOIR Coating	Ejector
7	1.0	STANDARD	FF716R	-	FK948R	-	FK948B	-
7	2.0	STANDARD	FF718R	-	FK949R	-	FK949B	✓
7	3.0	STANDARD	FF750R	-	FK950R	✓	FK950B	✓
7	4.0	STANDARD	FF752R	-	FK951R	✓	FK951B	✓
7	5.0	STANDARD	FF754R	-	FK952R	✓	FK952B	✓
7	6.0	STANDARD	FF755R	-	FK953R	✓	FK953B	✓

8	1.0	STANDARD	FF025R	-
8	2.0	STANDARD	FF026R	-
8	3.0	STANDARD	FF027R	-
8	4.0	STANDARD	FF028R	-
8	5.0	STANDARD	FF029R	-



Working Length (in.)	Jaw Size (mm)	Footplate	Non Detachable, Silver	Ejector
7	1	THIN	FF115R	-
7	2	THIN	FF116R	-
7	3	THIN	FF117R	-
7	4	THIN	FF118R	-
7	5	THIN	FF119R	-

8	2	THIN	FF077R	-
8	3	THIN	FF078R	-
8	4	THIN	FF079R	-
8	5	THIN	FF080R	-



Orthopedics/Spine

Kerrison Bone Punches

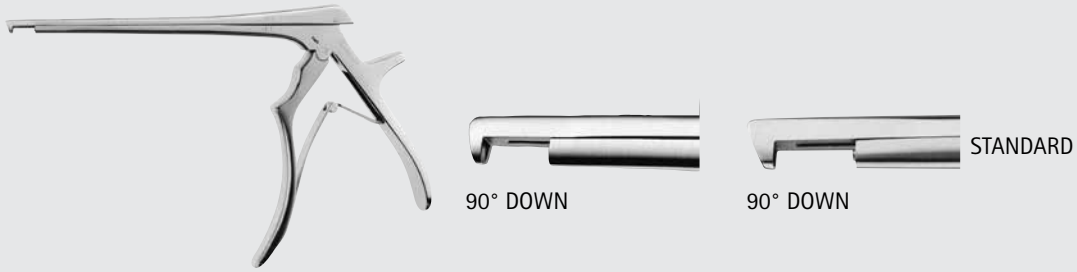

Working Length (in.)	Jaw Size (mm)	Footplate	Non Detachable, Silver	Ejector	Detachable, Silver	Ejector
7	1.0	STANDARD	FF741R	-	FK954R	-
7	2.0	STANDARD	FF719R	-	FK955R	-
7	3.0	STANDARD	FF721R	-	FK956R	✓
7	4.0	STANDARD	FF742R	-	FK957R	✓
7	5.0	STANDARD	FF723R	-	FK958R	✓
7	6.0	STANDARD	FF743R	-		

8	2	STANDARD	FF828R	-
8	3	STANDARD	FF829R	-
8	4	STANDARD	FF830R	-
8	5	STANDARD	FF831R	-
8	6	STANDARD	FF841R	-



Working Length (in.)	Jaw Size (mm)	Footplate	Non Detachable, Silver	Ejector
7	1.0	THIN	MF136R	-
7	2.0	THIN	FF816R	-
7	3.0	THIN	FF817R	-
7	4.0	THIN	FF819R	-
7	5.0	THIN	FF821R	-

8	1.0	THIN	FF809R	-
8	2.0	THIN	FF812R	-
8	3.0	THIN	FF813R	-
8	5.0	THIN	FF815R	-

Foraminotomy Kerrison

- Non Detachable design
- Upward curve allows for easier bone removal, providing improved access to the underside of the foramen

KERRISON Foraminotomy Bone Punch

Catalog Number	Jaw Size (mm)	Jaw Opening (mm)	Working Length (in.)
FF466R	2.0	10	7 7/8
FF467R	3.0	10	7 7/8
FF468R	4.0	10	7 7/8
FF469R	5.0	10	7 7/8

FF466R-FF469R

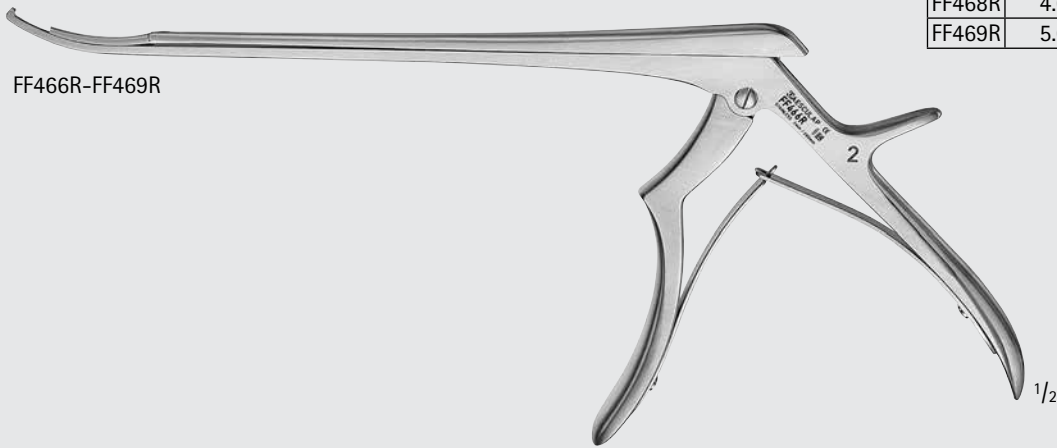

Bayonet-Shaped Kerrison bone punch

- Non Detachable design
- Bayonet shape allows better view over the KERRISON and increased visibility of surgical site
- Easily used through a retractor tube for MIS procedures

KERRISON Bayonet-Shaped Bone Punch, 40° upbiting

Catalog Number	Jaw Size (mm)	Jaw Opening (mm)	Working Length (in.)
FF496R	2.0	10	9 1/2
FF497R	3.0	10	9 1/2
FF498R	4.0	10	9 1/2
FF499R	5.0	10	9 1/2

FF496R-FF499R



INCHES

Orthopedics/Spine

KAIRison® Pneumatic Bone Punch

KAIRison Pneumatic Bone Punch

- Easy handling
- Reduces physical effort required
- Relieves strain on hands and joints
- Less risk of reduced motor skills through fatigue
- Innovative safety mechanism
- Short learning curve
- Excellent balance
- Suitable for right- or left-handed use
- Reliable; does not jam
- Ergonomic design

For more information see our brochure DOC763.

KAIRison Pneumatic Bone Punch

Catalog Number	Jaw Size (mm)	Jaw Opening (mm)	Footplate	Ejector	Total Length (in.)
FK882R	2.0	12	STANDARD	✓	9 1/4
FK883R	3.0	12	STANDARD	✓	9 1/4
FK884R	4.0	12	STANDARD	✓	9 1/4
FK885R	5.0	12	STANDARD	✓	9 1/4
FK886R	6.0	12	STANDARD	✓	9 1/4
FK892R	2.0	12	STANDARD	✓	11 1/4
FK893R	3.0	12	STANDARD	✓	11 1/4
FK894R	4.0	12	STANDARD	✓	11 1/4
FK895R	5.0	12	STANDARD	✓	11 1/4
FK896R	6.0	12	STANDARD	✓	11 1/4

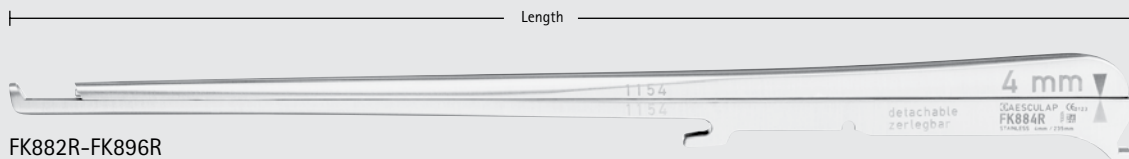

FK882R-FK896R



Width (mm)

2.0 3.0 4.0 5.0 6.0

KAIRison Pneumatic Punch Handle

FK899R



Catalog Number
FK899R

Punch Bracket For Pressure Reducer



Pressure Reducer

FK898R-FK898214

KAIRison Pressure Reducer

Catalog Number	Description
FK898R	PRESSURE REDUCER
FK887R	BRACKET FOR PRESSURE REDUCER
FK898215	RUBBER CAP, SMALL
FK898214	RUBBER CAP, LARGE

Orthopedics/Spine

KAIRison® Pneumatic Bone Punch

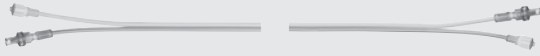

FK888SU

Disposable Tubes for KAIRison Pneumatic Punch

Catalog Number	Packaging
FK888SU	PAK = Package of 10

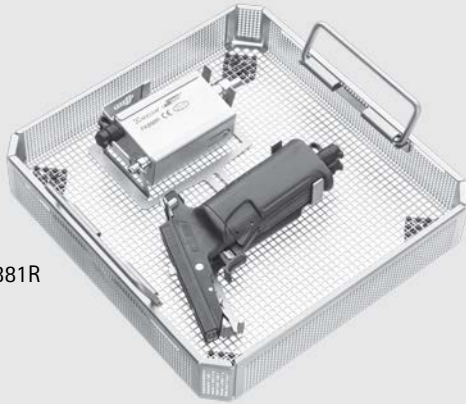

FK881R

Storage Rack for KAIRison Handle and Pressure Reducer

Catalog Number
FK881R

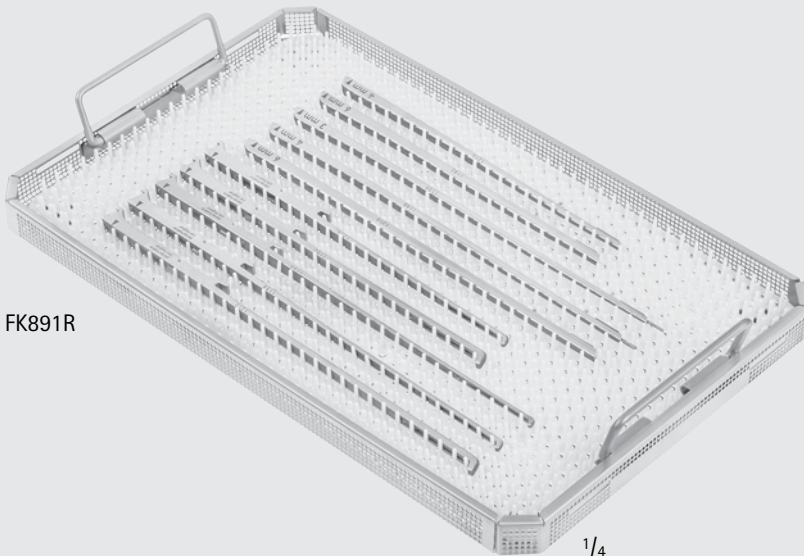

FK891R

Storage Rack for KAIRison Shafts

Catalog Number
FK891R



GA468R

Pneumatic Hose with Aesculap-Schrader Connection

Catalog Number	Length (m)
GA468R	5



ORTHO
SPINE

INCHES

Orthopedics/Spine

Bone Cutters



FO601R-FO602R

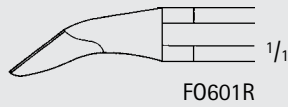

FO601R

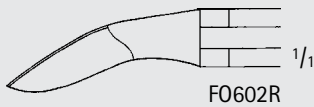

FO602R

Bone Cutting Forceps

Catalog Number	Jaw	Length (in.)
FO601R	UP	5 1/8
FO602R	UP	6 3/4



FO604R

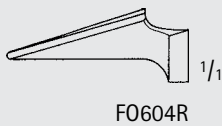

FO604R

STAMM Bone Cutting Forceps

Catalog Number	Length (in.)
FO604R	6



FO612R

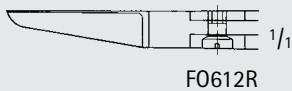

FO612R

Bone Cutting Forceps, Double Action

Catalog Number	Jaw	Length (in.)
FO612R	STR	6 3/4



LISTON Bone Cutting Forceps

Catalog Number	Jaw	Length (in.)
F0620R	STR, Single Action	5 1/2
F0622R	STR, Single Action	6 3/4
F0624R	STR, Single Action	7 7/8
F0626R	STR, Single Action	8 3/4
F0632R	ANG, Single Action	6 3/4
F0634R	ANG, Single Action	7 7/8
F0636R	ANG, Single Action	8 3/4
F0645R	CVD, Double Action	9 1/2
F0646R	STR, Double Action	11
F0647R	CVD, Double Action	11



F0620R-F0636R

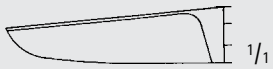

F0620R

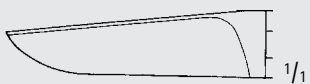

F0622R

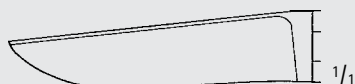

F0624R

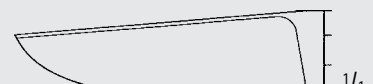

F0626R



F0632R



F0634R



F0636R

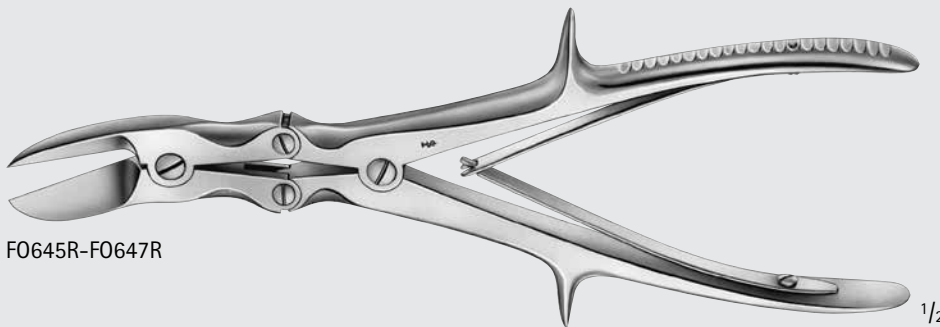

F0645R-F0647R

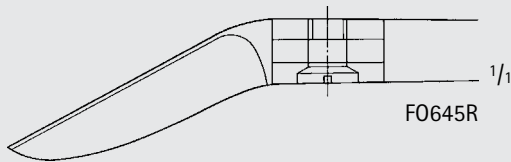

F0645R

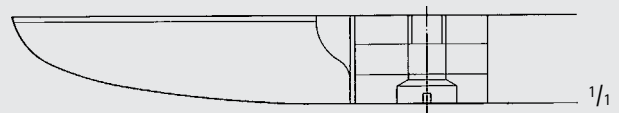

F0646R

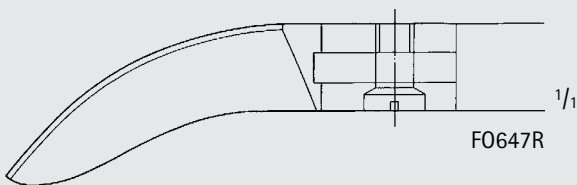

F0647R



ORTHO
SPINE

INCHES

Orthopedics/Spine

Bone Cutters



FO610R-FO611R

1/2

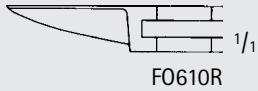

FO610R

1/1

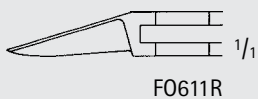

FO611R

1/1

BOEHLER Bone Cutting Forceps, Double Action

Catalog Number	Jaw	Length (in.)
FO610R	STR	5 3/4
FO611R	ANG	5 3/4



FO614R

1/2

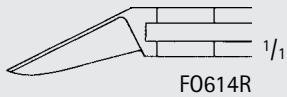

FO614R

1/1

MCINDOE Bone Cutting Forceps, Double Action

Catalog Number	Jaw	Length (in.)
FO614R	ANG	6 7/8



FO640R-FO641R

1/2

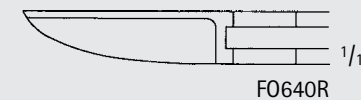

FO640R

1/1

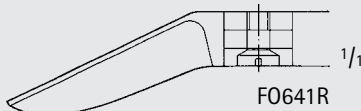

FO641R

1/1

RUSKIN-LISTON Bone Cutting Forceps, Double Action

Catalog Number	Jaw	Length (in.)
FO640R	STR	7 1/2
FO641R	ANG	7 1/2

ORTHO
SPINE

MILLIMETERS

LISTON-STILLE Bone Cutting Forceps, 90° Angle

Catalog Number	Length (in.)
F0648R	10 1/2

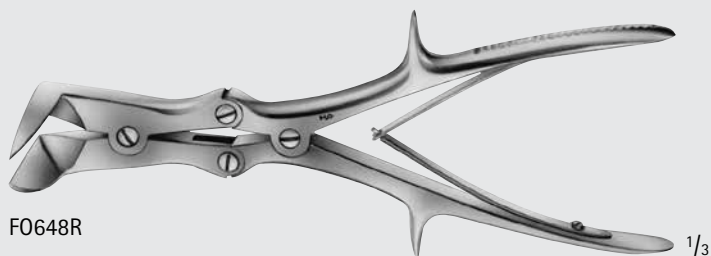

F0648R

1/3

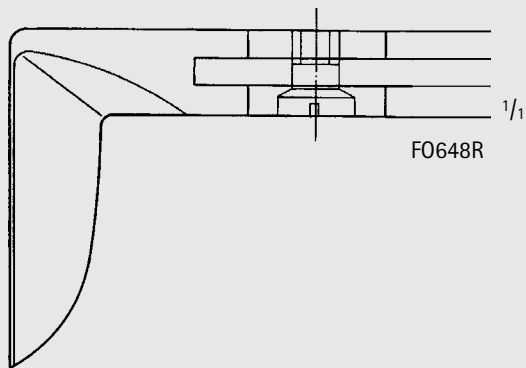

F0648R

1/1

LISTON-KEY-HORSLEY Bone Cutting Forceps, Angled

Catalog Number	Length (in.)
F0649R	10

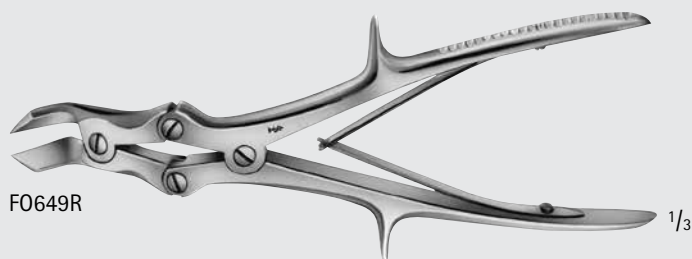

F0649R

1/3

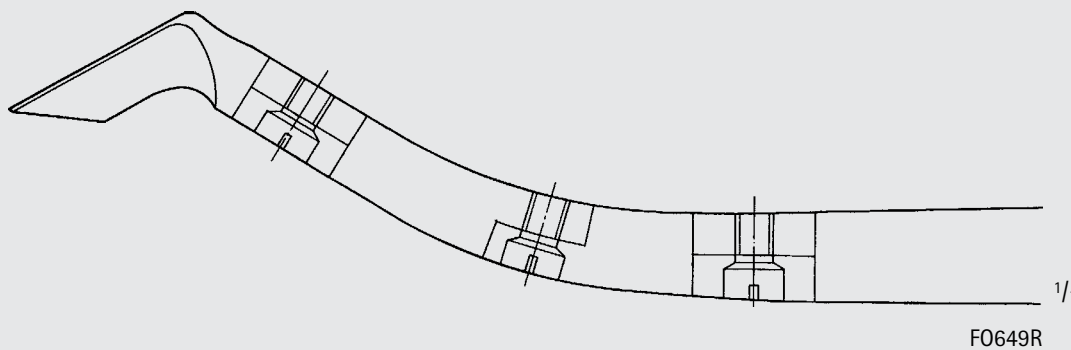

F0649R

1/1

KAZANJIAN Bone Cutting Forceps, Straight

Catalog Number	Length (in.)
OK378R	7 1/4



OK378R

1/2

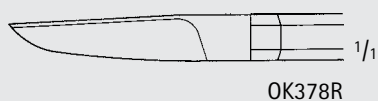

OK378R

1/1



Orthopedics/Spine

Rulers, Calipers and Gauges



AA847R

Caliper for Inner Diameter and Outer Diameter

Catalog Number	Measuring Range	Length (in.)
AA847R	UP TO 100MM	5 1/8
AA846R	UP TO 150MM	9



AA846R

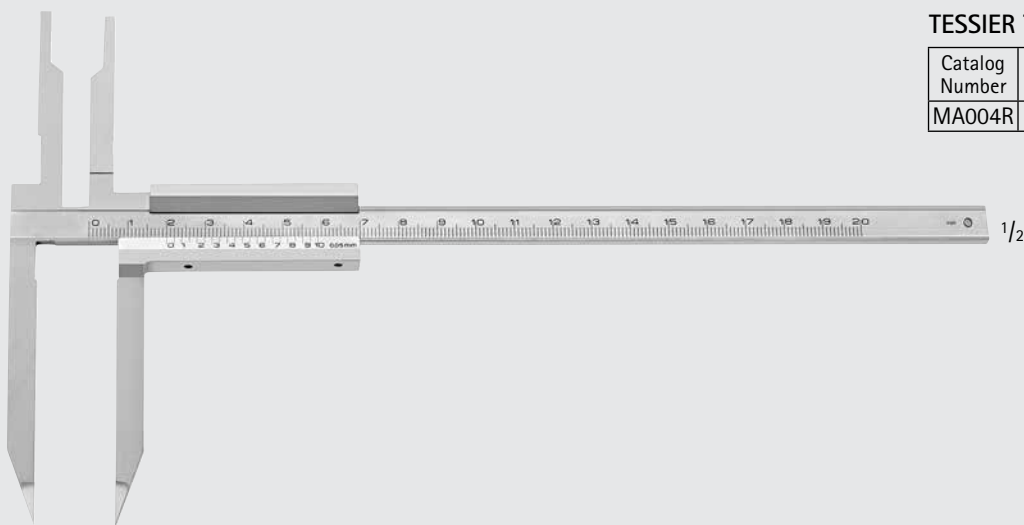

MA004R

TESSIER Type Caliper

Catalog Number	Length (in.)
MA004R	10 1/4

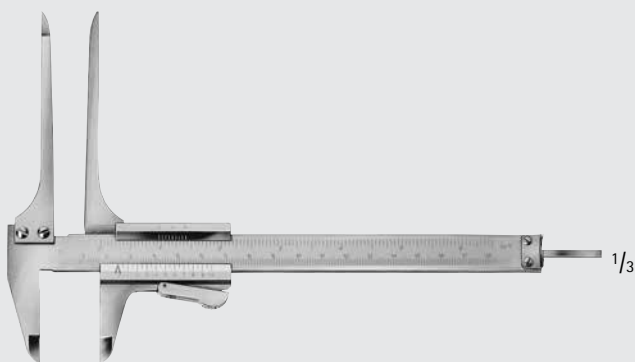

AA845R

CASPAR Neuro Caliper F/ Bone Graft

Catalog Number	Length (in.)
AA845R	8 7/8





MB983R

TOWNLEY Femur Caliper

Catalog Number	Length (in.)
MB983R	4



AA804R-AA806R

Steel Ruler, Graduated In Millimeters and Inches

Catalog Number	Length (in.)
AA804R	6
AA805R	11 3/4
AA806R	19 3/4

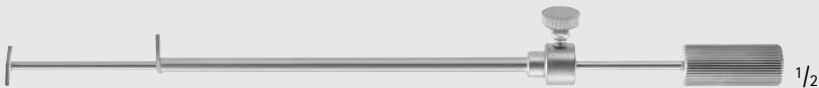

MD531R

CLOWARD Style Depth Gauges

Catalog Number	Size	Length (in.)
MD531R	LARGE	8

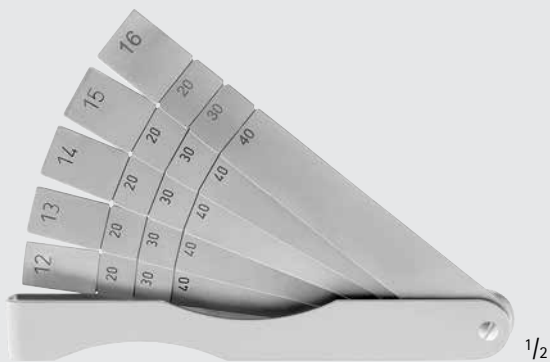

MD534R

CLOWARD Spanner Gauges

Catalog Number	Length (in.)
MD534R	5



Orthopedics/Spine

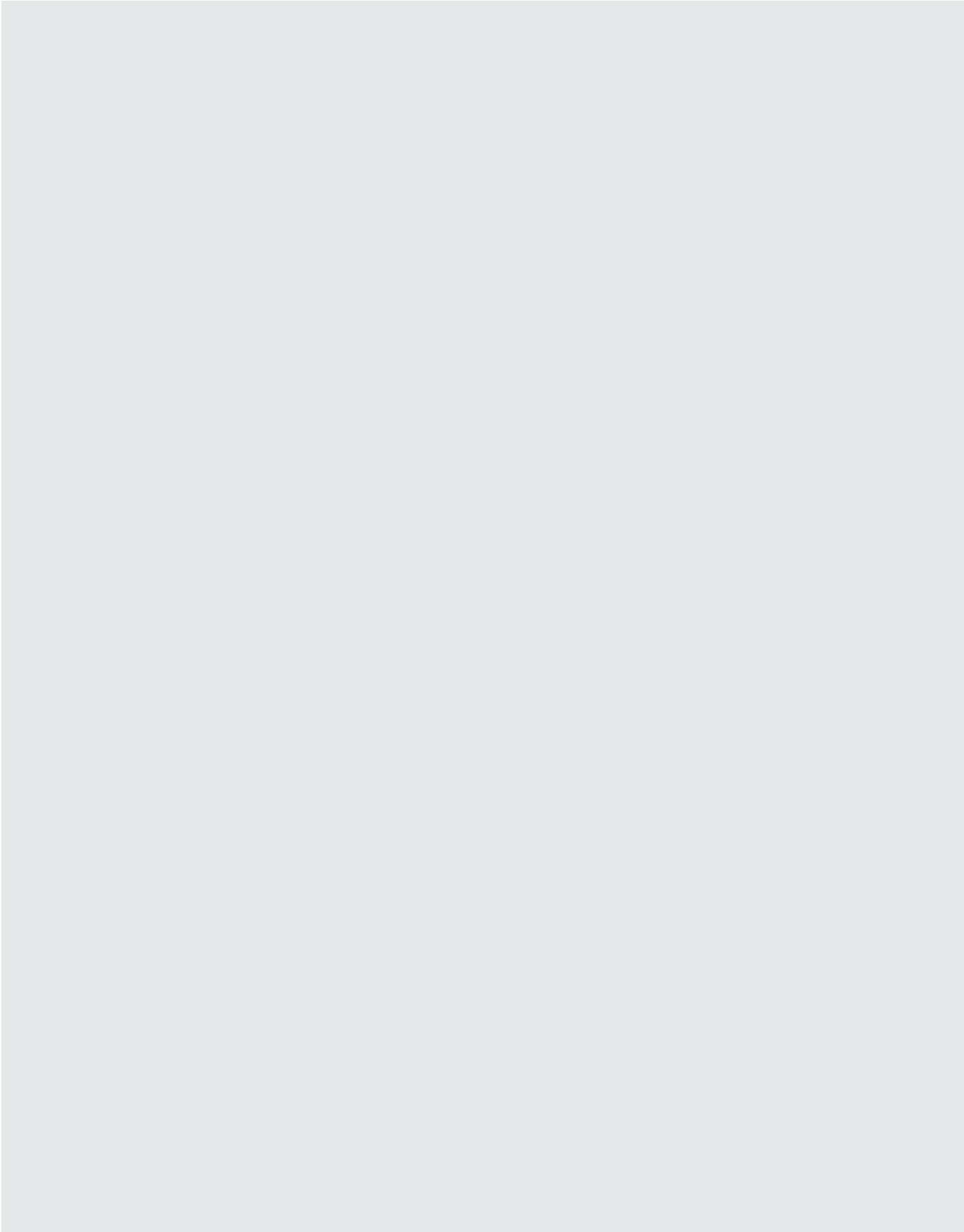



Neurosurgery

Skull Opening	1068 - 1073
Micro Scissors	1074 - 1077
Micro Forceps	1078 - 1079
Tumor Forceps	1079 - 1081
Micro Needle Holders	1082
MIN Instruments	1083 - 1087
SENSATION Instruments	1088 - 1095
XS Instruments	1096 - 1100
EC/IC Bypass Instruments	1101 - 1103
Skull Base Instruments	1104 - 1105
Micro Dissectors/Rasps/Hooks	1106 - 1122
Suture and Ligature Instruments	1123
Dural Separators	1124
Knives	1124 - 1126
Pituitary Instruments	1127 - 1143
Suction Cannulas	1144 - 1152
Elevators	1153
Retractors and Handrest Systems	1154 - 1162
Brain Spatulas	1163 - 1165

Neurosurgery

Skull Opening



FF007P

ScalpFix® Applicator, Polymer

Catalog Number
FF007P



FF012R

ScalpFix Applicator, Aluminum

Catalog Number
FF012R

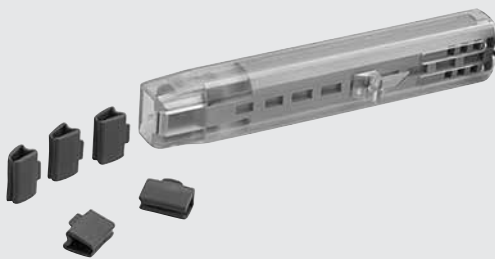

FF013P

ScalpFix Scalp Clip, Single Use

Catalog Number	Packaging
FF013P	BOX = 20 PAC OF 10 PC (200 CLIPS TOTAL)

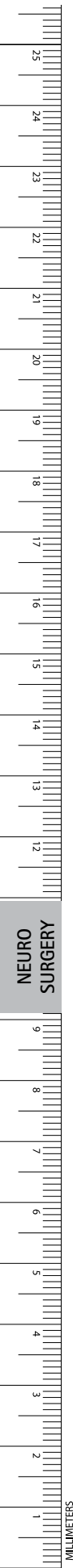

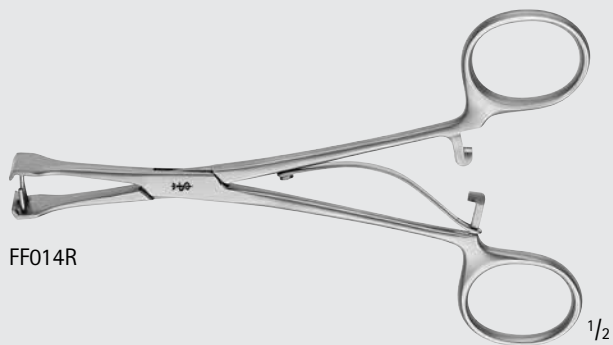

FF014R

1/2

ScalpFix® Removal Forceps

Catalog Number	Length (in.)
FF014R	6



FF015P

1/1

RANEY Plastic Scalp Hemostasis Clip, Sterile

Catalog Number	Sales Unit
FF015P	BOX = 20 PACK OF 10 PC (200 CLIPS TOTAL)

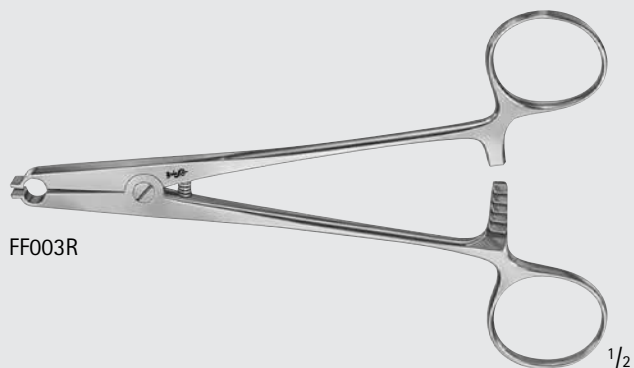

FF003R

1/2

RANEY Applying and Removing Forceps for Scalp Hemostasis Clips

Catalog Number	Compatible w/	Length (in.)
FF003R	FF015P	6 1/4



FF005R

1/2

Scalp Hemostasis Clip

Catalog Number	Sales Unit
FF005R	BOX OF 10

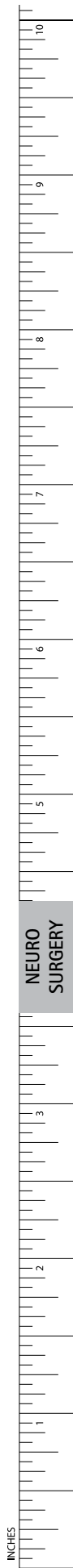

INCHES

Neurosurgery

Skull Opening

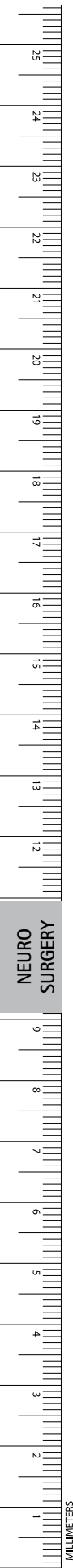

Scalp Flap Forceps

Catalog Number	Author	Shape	Length (in.)
FF010R	DEMARTEL	SLIGHT-CVD	5 1/4
FF011R	WILLETT-DEMARTEL	SLIGHT-CVD	7 1/4

FF010R-FF011R

FF010R 1/1

FF011R 1/1

YASARGIL Spring Hook, F/ Galea Fixation W/ Bulldog Clamp

Catalog Number	Tip
FF020R	SMALL
FF022R	LARGE

FF020R-FF022R

FF020R 1/1

FF022R 1/1

Galea Hook, W/ Ball Chain

Catalog Number	Compatible w/
FF155R	FF154R

FF155R



FF155R 1/1

Galea Hook, W/ Ball Chain and Spiral Spring

Catalog Number	Compatible w/
FF156R	FF154R

FF156R

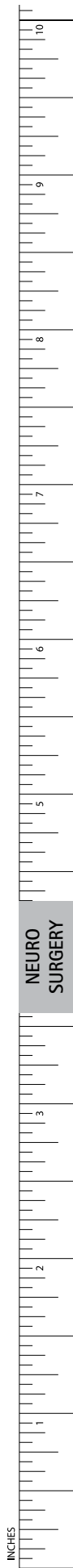
FF156R 1/1





FF056R

1/2

HUDSON Drill Brace

Catalog Number
FF056R



FF057R

1/2

HUDSON Drill Brace Extension

Catalog Number
FF057R



FF061R

FF062R

FF063R

FF064R

1/2

1/2

1/2

1/2

HUDSON Burr

Catalog Number	Diameter (mm)
FF061R	9.0
FF062R	14.0
FF063R	16.0
FF064R	22.0



FF065R

1/2

ADSON Burr

Catalog Number	Diameter (mm)
FF065R	15.0



FF066R

1/2

MCKENZIE Twist Drill

Catalog Number	Diameter (mm)
FF066R	13.0



FF067R

1/2

CUSHING Flat Drill

Catalog Number	Diameter (mm)
FF067R	14.0



FF068R

1/2

Twist Drill

Catalog Number	Diameter (mm)
FF068R	2.0

Neurosurgery

Skull Opening

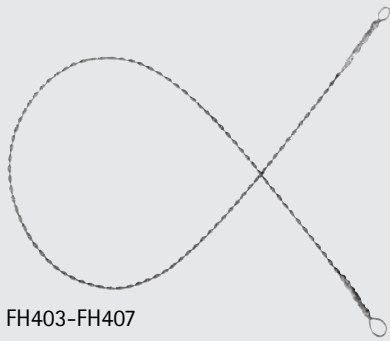

FH403-FH407



FH403-FH407 ^{5/1}

OLIVECRONA Wire Saw

Catalog Number	Diameter (mm)	Sales Unit	Length (in.)
FH403	1.2	BOX OF 5	11 3/4
FH404	1.2	BOX OF 5	15 3/4
FH405	1.2	BOX OF 5	19 3/4
FH407	1.2	BOX OF 5	27 1/2

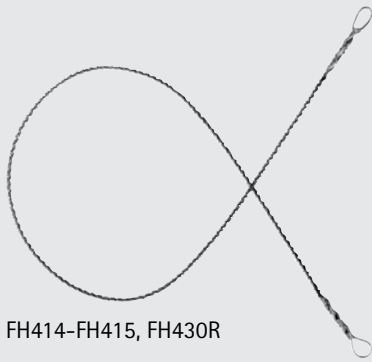

FH414-FH415, FH430R



FH414-FH415, FH430R ^{5/1}

GIGLI Wire Saw

Catalog Number	Diameter (mm)	Wires	Sales Unit	Length (in.)
FH414	1.4	6	BOX OF 5	15 3/4
FH415	1.4	6	BOX OF 5	19 3/4
FH430R	1.8	4	BOX OF 5	19 3/4

NEURO SURGERY

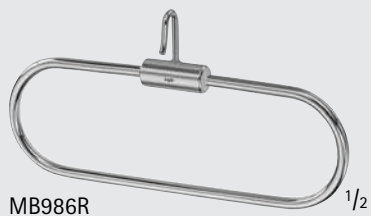

MB986R

1/2

GIGLI Saw Handle F/ Wire Saws

Catalog Number	Packaging
MB986R	2 PER PACKAGE



FH480R

1/2

GIGLI Hook Handle, F/ Wire Saws

Catalog Number	Packaging
FH480R	2/SET

1/2



FF130R

DEMARTEL Conductor

Catalog Number	Compatible w/	Length (in.)
FF130R	GIGLI AND OLIVECRONA WIRE SAWS	13 3/4

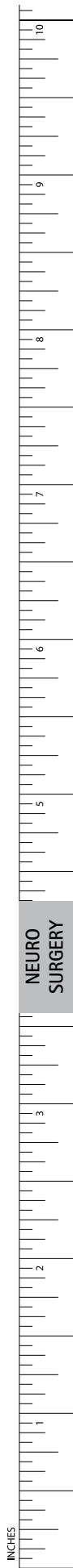

NEURO SURGERY

INCHES

Neurosurgery

Micro Scissors, Bayonet-Shaped

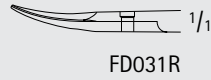
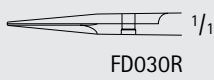

YASARGIL Micro Scissors

Catalog Number	Tip	Blade	Length (in.)
FD030R	S/S	STR	6 1/2
FD031R	S/S	CVD-UP	6 1/2

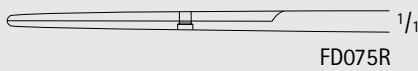

YASARGIL Micro Dissecting Scissors

Catalog Number	Tip	Blade	Length (in.)
FD075R	B/B	STR	7 1/4

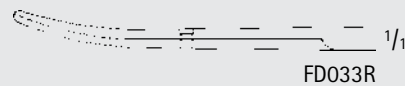
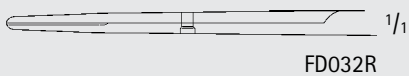

YASARGIL Micro Dissecting Scissors

Catalog Number	Tip	Blade	Length (in.)
FD032R	B/B	STR, SERR	7 7/8
FD033R	B/B	CVD-UP, SERR	7 7/8

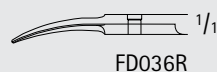
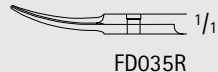
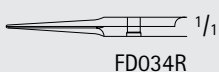

YASARGIL Micro Scissors

Catalog Number	Tip	Blade	Length (in.)
FD034R	S/S	STR, SERR	7 7/8
FD035R	S/S	CVD-UP, SERR	7 7/8
FD036R	S/S	CVD-DOWN, SERR	7 7/8

NEURO SURGERY

MILLIMETERS

Neurosurgery

Micro Scissors, Bayonet-Shaped

YASARGIL Micro Scissors

Catalog Number	Tip	Blade	Length (in.)
FD038R	S/S	STR	8 7/8
FD039R	S/S	CVD-UP	8 7/8
FD060R	S/S	STR, TOOTHED	8 7/8

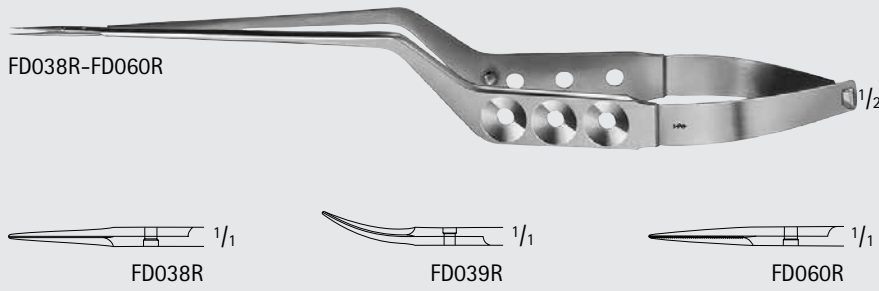

YASARGIL Micro Dissecting Scissors

Catalog Number	Tip	Blade	Length (in.)
FD044R	S/S	STR	8 7/8
FD043R	S/S	CVD-UP	8 7/8

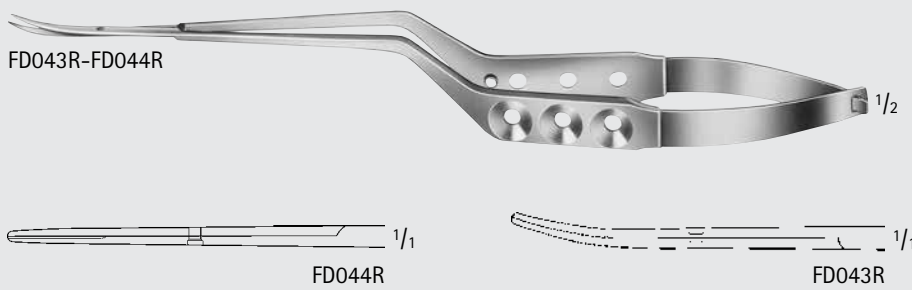

YASARGIL Micro Scissors

Catalog Number	Tip	Blade	Length (in.)
FD037R	S/S	STR	8 7/8
FD040R	S/S	CVD-UP	8 7/8

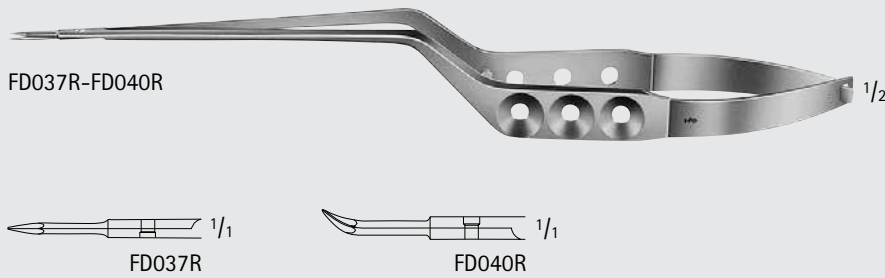

YASARGIL Micro Scissors

Catalog Number	Tip	Blade	Length (in.)
FD061R	S/S	CVD-UP	9 5/8



NEURO SURGERY

INCHES

Neurosurgery

Micro Scissors, Bayonet-Shaped



FD062R

YASARGIL Wire Cutting Scissors

Catalog Number	Tip	Blade	Length (in.)
FD062R	S/S	1-SERR	8 1/4



FD062R



FD105R-FD108R

Micro Vessel Scissors

Catalog Number	Tip	Blade	Length (in.)
FD105R	S/S	STR	7 1/2
FD106R	S/S	CVD	7 1/2
FD107R	S/S	DEL, STR	7 1/2
FD108R	S/S	DEL, CVD	7 1/2

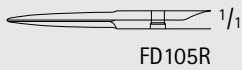

FD105R

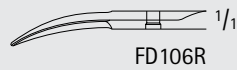

FD106R

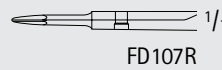

FD107R

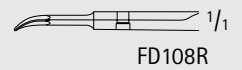

FD108R

NEURO SURGERY

Neurosurgery

Micro Scissors, Bayonet-Shaped



FD056R-FD057R



FD056R

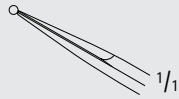

FD057R

NAGEL Micro Scissors

Catalog Number	Tip	Blade	Length (in.)
FD056R	S/S	45°	7 7/8
FD057R	1 BALL-PT	45°	7 7/8

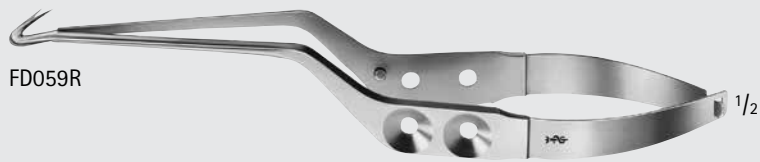

FD059R



FD059R

DEBAKEY Circumflex Micro Scissors

Catalog Number	Tip	Blade	Length (in.)
FD059R	S/S	125°	7 1/2

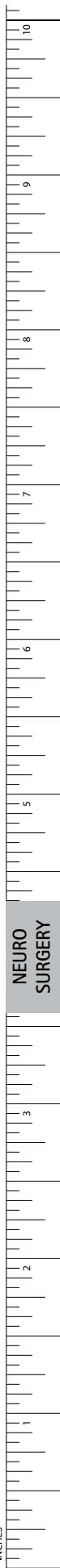

INCHES

Neurosurgery

Micro Forceps

BD835R-BD837R

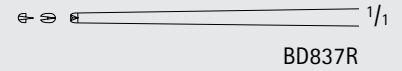
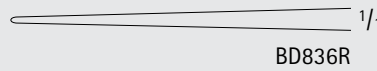
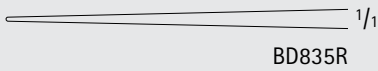

YASARGIL Micro Forceps, Bayonet-Shaped

Catalog Number	Tip Size (mm)	Teeth	Length (in.)
BD835R	0.6	-	7
BD836R	0.9	-	7
BD837R	-	1 x 2	7

BD840R-BD841R

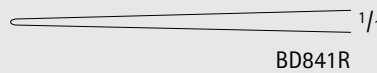
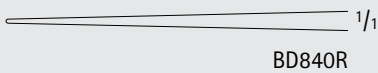

YASARGIL Micro Forceps, Bayonet-Shaped

Catalog Number	Tip Size (mm)	Length (in.)
BD840R	0.6	7 7/8
BD841R	0.9	7 7/8

BD845R-BD846R

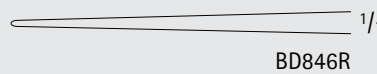
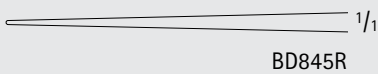

YASARGIL Micro Forceps, Bayonet-Shaped

Catalog Number	Tip Size (mm)	Length (in.)
BD845R	0.6	8 3/4
BD846R	0.9	8 3/4

BD850R-BD851R

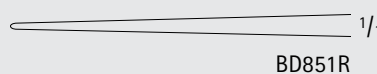
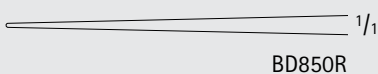

YASARGIL Micro Forceps, Bayonet-Shaped

Catalog Number	Tip Size (mm)	Length (in.)
BD850R	0.6	9 1/2
BD851R	0.9	9 1/2

NEURO SURGERY



BD888R

1/2

**Gruenwald Micro Forceps,
Bayonet-Shaped**

Catalog Number	Teeth	Length (in.)
BD888R	1 x 2	6 1/4

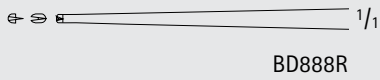

BD888R

1/1



MD536R

1/2

PENFIELD Watchmaker Forceps

Catalog Number	Length (in.)
MD536R	7



MD536R

1/1



BD765R

1/2

**HUNT Grasping Forceps,
Bayonet-Shaped**

Catalog Number	Tip	Shape	Diameter (mm)	Length (in.)
BD765R	ANG	STR	4.5	7 7/8

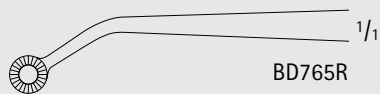

BD765R

1/1

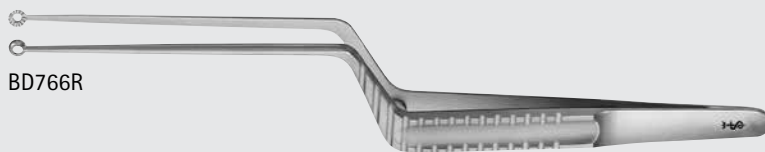

BD766R

**HUNT Grasping Forceps,
Bayonet-Shaped**

Catalog Number	Tip	Shape	Diameter (mm)	Length (in.)
BD766R	STR	BAYONET	4.5	7 7/8

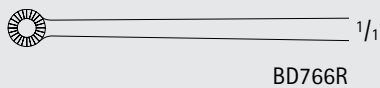

BD766R

1/1

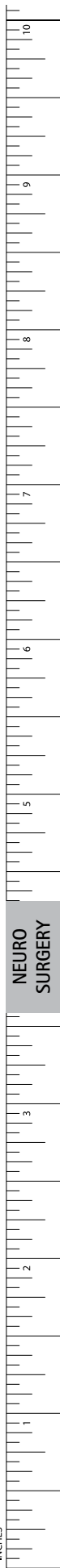

NEURO SURGERY

INCHES

Neurosurgery

Tumor Forceps

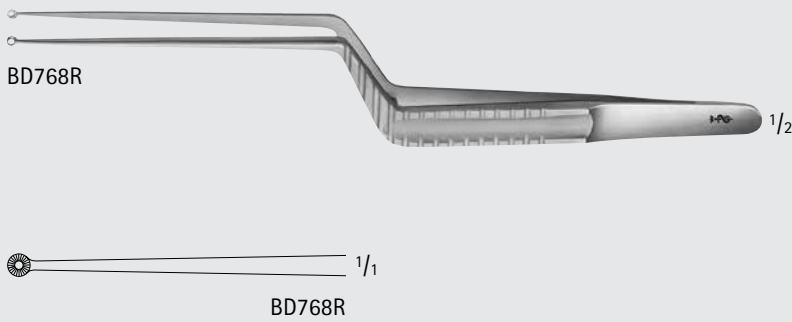

**YASARGIL Grasping Forceps,
Bayonet-Shaped**

Catalog Number	Tip	Shape	Diameter (mm)	Length (in.)
BD768R	STR	BAYONET	3.0	7 7/8

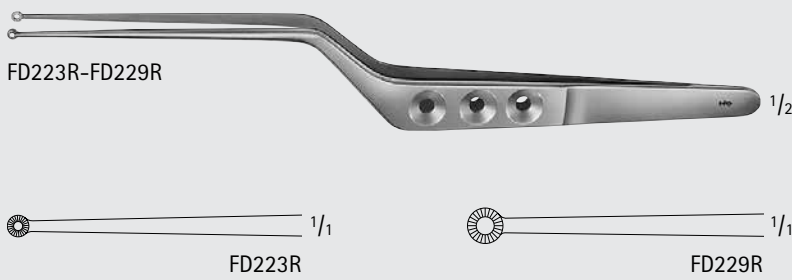

**YASARGIL Micro Forceps,
Bayonet-Shaped**

Catalog Number	Diameter (mm)	Length (in.)
FD223R	3.0	7 7/8
FD229R	5.0	7 7/8

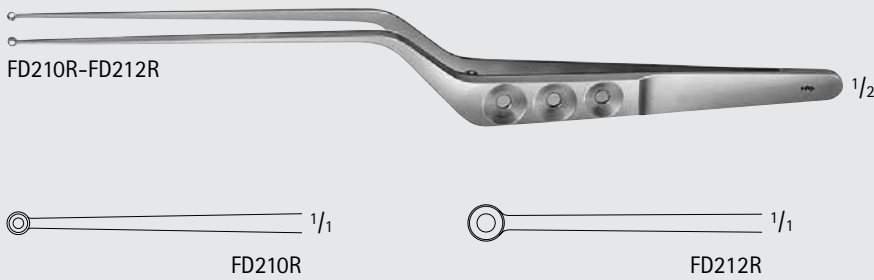

**YASARGIL Grasping Forceps,
Bayonet-Shaped**

Catalog Number	Jaw	Diameter (mm)	Length (in.)
FD210R	SPOON-SHAPED	3.0	8 3/4
FD212R	SPOON-SHAPED	5.0	8 3/4

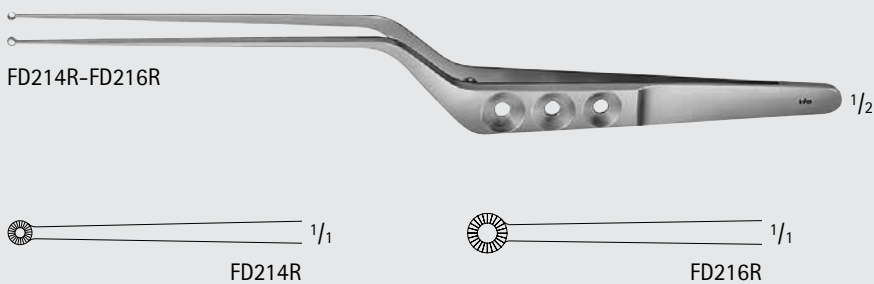

**YASARGIL Grasping Forceps,
Bayonet-Shaped**

Catalog Number	Jaw	Diameter (mm)	Length (in.)
FD214R	FLAT/SERR	3.0	8 3/4
FD216R	FLAT/SERR	5.0	8 3/4

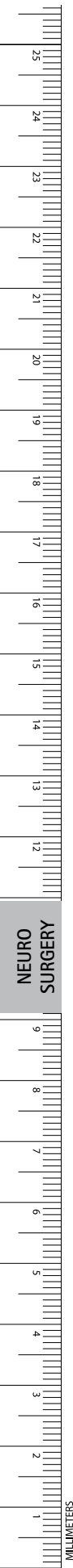



**HEIFETZ Grasping Forceps,
Bayonet-Shaped**

Catalog Number	Jaw	Diameter (mm)	Length (in.)
FD215R	CURETTE, TOOTHED	3.0	8 3/4
FD217R	CURETTE, TOOTHED	5.0	8 3/4

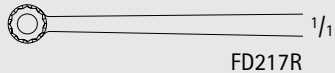
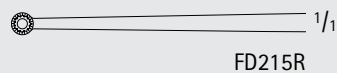

**YASARGIL-SAMII Grasping Forceps,
Bayonet-Shaped**

Catalog Number	Jaw	Diameter (mm)	Length (in.)
FD200R	SPOON-SHAPED	3.0	9 1/2
FD202R	SPOON-SHAPED	5.0	9 1/2
FD204R	SPOON-SHAPED	7.0	9 1/2

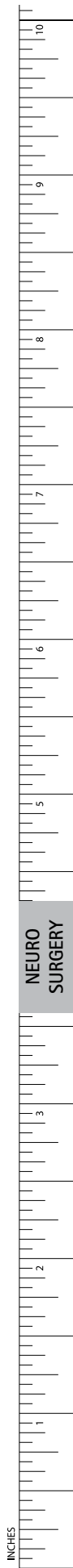
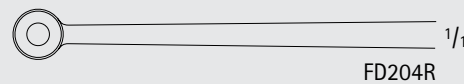
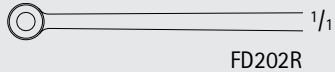
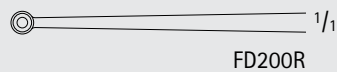
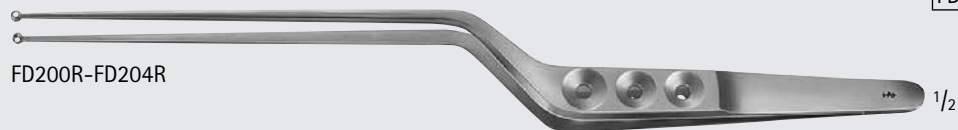

Neurosurgery

Micro Needle Holder, Bayonet-Shaped



FD092R-FD093R

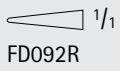

FD092R

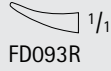

FD093R

YASARGIL Micro Needle Holder

Catalog Number	Tip	Length (in.)
FD092R	STR	7 7/8
FD093R	CVD-UP	7 7/8



FD096R-FD097R

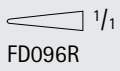

FD096R

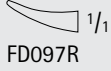

FD097R

YASARGIL Micro Needle Holder

Catalog Number	Tip	Length (in.)
FD096R	STR	8 7/8
FD097R	CVD-UP	8 7/8

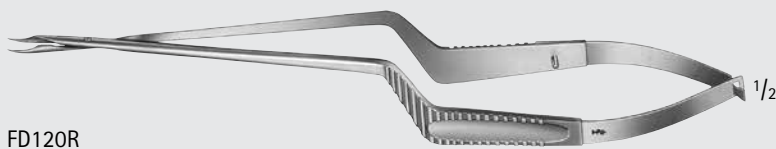

FD120R

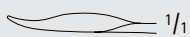

Micro Needle Holder

Catalog Number	Tip	Length (in.)
FD120R	CVD-UP	7 3/4

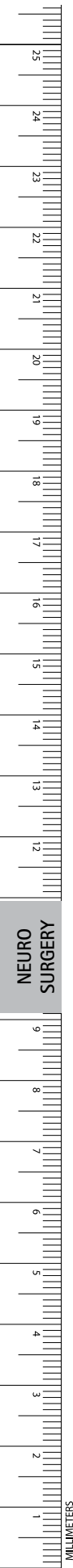

NEURO SURGERY

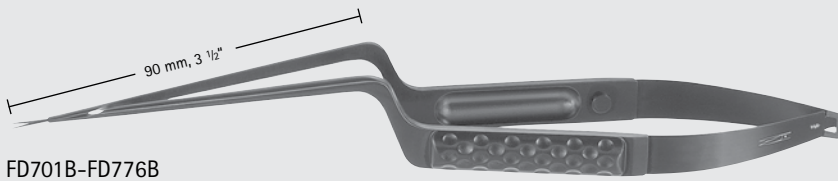

MIN, Noir Micro Scissors W/ Golfball Handle, Serrated Blades

Catalog Number	Tip	Blade	Working Length (in.)	Length (in.)
FD701B	S/S	STR	2 3/4	7 7/8
FD702B	S/S	SLIGHT-CVD	2 3/4	7 7/8
FD703B	S/S	CVD	2 3/4	7 7/8
FD704B	B/B	STR	2 3/4	7 7/8
FD705B	B/B	SLIGHT-CVD	2 3/4	7 7/8
FD706B	B/B	CVD	2 3/4	7 7/8
FD731B	S/S	STR	3 1/2	8 3/4
FD732B	S/S	SLIGHT-CVD	3 1/2	8 3/4
FD733B	S/S	CVD	3 1/2	8 3/4
FD734B	B/B	STR	3 1/2	8 3/4
FD735B	B/B	SLIGHT-CVD	3 1/2	8 3/4
FD736B	B/B	CVD	3 1/2	8 3/4
FD771B	S/S	STR	4 3/4	9 3/4
FD772B	S/S	SLIGHT-CVD	4 3/4	9 3/4
FD773B	S/S	CVD	4 3/4	9 3/4
FD774B	B/B	STR	4 3/4	9 3/4
FD775B	B/B	SLIGHT-CVD	4 3/4	9 3/4
FD776B	B/B	CVD	4 3/4	9 3/4

FD701B-FD776B



FD701B, FD704B



FD702B, FD705B

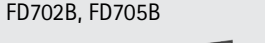

FD703B, FD706B



FD701B-FD703B

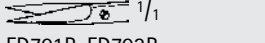

FD704B-FD706B

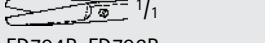

FD731B, FD734B



FD732B-FD735B



FD733B-FD736B

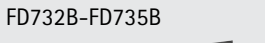

FD731B-FD733B



FD734B-FD736B

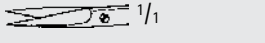

FD771B, FD774B

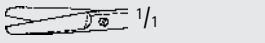

FD772B, FD775B



FD773B, FD776B



FD771B-FD773B

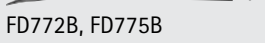

FD774B-FD776B



FD771B-FD773B

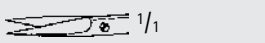

FD774B-FD776B

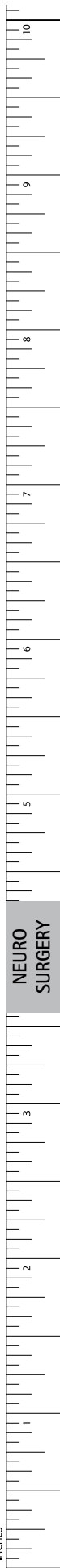

NEURO SURGERY

INCHES

Neurosurgery

MIN Instruments - Noir™ Micro Needle Holders/Noir™ Micro Tissue Forceps/Noir™ Micro Tumor Forceps, Bayonet-Shaped



FD717B-FD719B



FD717B-FD719B

MIN, Noir Micro Needle Holder W/ Golfball Handle

Catalog Number	Suture Size	Working Length (mm)	Length (in.)
FD717B	7/0 AND SMALLER	70	7 7/8
FD718B	7/0 AND SMALLER	90	8 3/4
FD719B	7/0 AND SMALLER	120	9 3/4

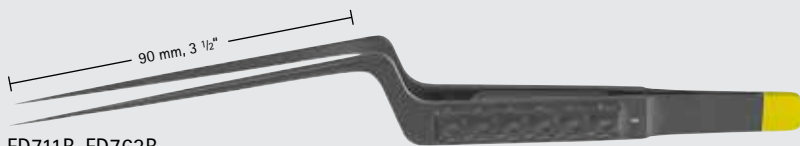

FD711B-FD763B

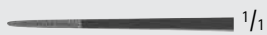

FD711B, FD741B, FD761B

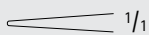

FD713B, FD743B, FD763B

MIN, Noir Micro Tissue Forceps W/ Golfball Handle

Catalog Number	Tip	Tip Size (mm)	Working Length (in.)	Length (in.)
FD711B	STR	0.5	2 3/4	7 1/2
FD713B	STR	0.9	2 3/4	7 1/2
FD741B	STR	0.5	3 1/2	8 1/4
FD743B	STR	0.9	3 1/2	8 1/4
FD761B	STR	0.5	4 3/4	9 1/2
FD763B	STR	0.9	4 3/4	9 1/2

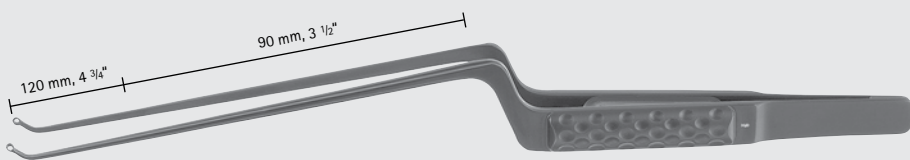

FD767B-FD789B



FD766B, FD769B, FD786B, FD789B



FD767B, FD787B

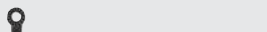

FD768B, FD788B



FD766B-FD768B, FD786B-FD788B



FD769B, FD789B

MIN, Noir Micro Tumor Forceps W/ Golfball Handle

Catalog Number	Tip	Tip Size (mm)	Working Length (in.)	Length (in.)
FD766B	STR	2.5 RING	3 1/2	8 1/4
FD769B	STR	3.5 RING	3 1/2	8 1/4
FD767B	45° CVD	2.5 RING	3 1/2	8 1/4
FD768B	90° CVD	2.5 RING	3 1/2	8 1/4
FD786B	STR	2.5 RING	4 3/4	9 1/2
FD789B	STR	3.5 RING	4 3/4	9 1/2
FD787B	45° CVD	2.5 RING	4 3/4	9 1/2
FD788B	90° CVD	2.5 RING	4 3/4	9 1/2

NEURO SURGERY

MILLIMETERS

MIN Set

- Fine instrument tips
- Round golfball handle design
- Various working lengths
- Slender design and angled bayonet-shape
- Noir, No Irritating Reflections



FD811B



FD812B

MIN, Noir Modular Handle F/ Golfball Handle Design

Catalog Number	Diameter (mm)	Length (in.)
FD811B	8	4
FD812B	11	4



FD818B



FD819B



FD848B



FD849B

MIN, Noir Modular Bayonet Handle F/ Golfball Handle Design

Catalog Number	Diameter (mm)	Description	Length (in.)
FD818B	8	LOW BAYONET (21 MM)	4
FD819B	11	LOW BAYONET (31 MM)	4
FD848B	8	HIGH BAYONET (21 MM)	4
FD849B	11	HIGH BAYONET (31 MM)	4

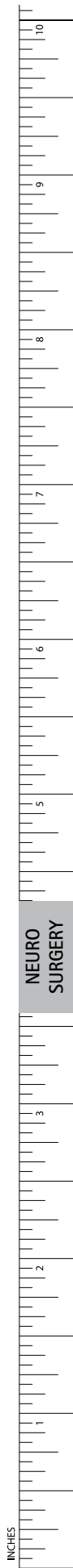

NEURO SURGERY

INCHES

Neurosurgery

MIN Instruments - Noir™ Micro Dissectors/Noir™ Rasps/Noir™ Hooks

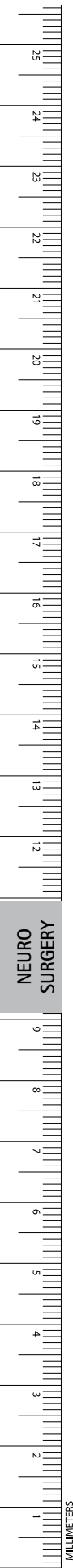

MIN, Noir Micro Probe F/ Modular Golfball Handle

Catalog Number	Tip	Length (in.)
FD797B	BALL-TIP 0°	7 7/8
FD798B	BALL-TIP 45°	7 7/8
FD799B	BALL-TIP 90°	7 7/8



MIN, Noir Micro Hook F/ Modular Golfball Handle

Catalog Number	Tip	Length (in.)
FD808B	45°, BLUNT	7 7/8
FD805B	90°, BLUNT	7 7/8
FD809B	90°, SHARP	7 7/8

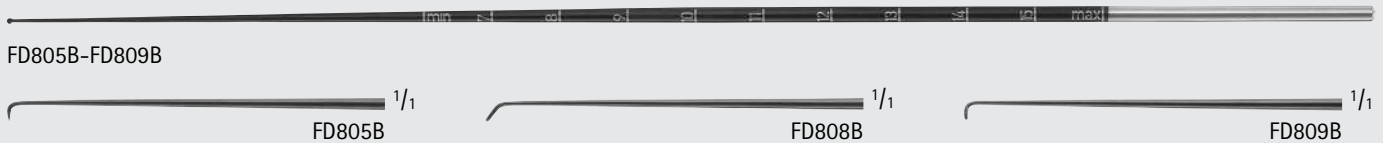

MIN, Noir Micro Scoop F/ Modular Golfball Handle

Catalog Number	Tip	Tip Size (mm)	Length (in.)
FD814B	10°	2	7 7/8
FD815B	45°	2	7 7/8
FD816B	45° W/ NECK	2	7 7/8

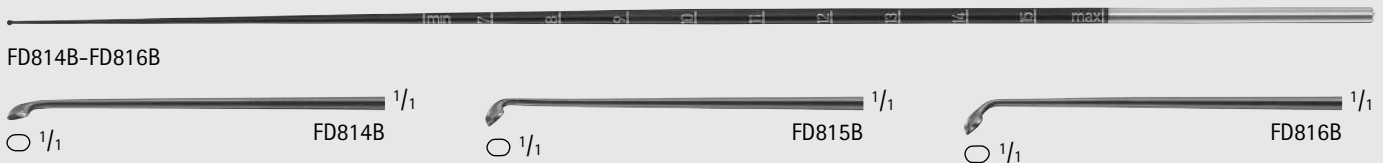

MIN, Noir Micro Dissector F/ Modular Golfball Handle

Catalog Number	Tip	Tip Size (mm)	Length (in.)
FD821B	CVD	1.0	7 7/8
FD822B	CVD	2.0	7 7/8
FD823B	CVD	3.0	7 7/8

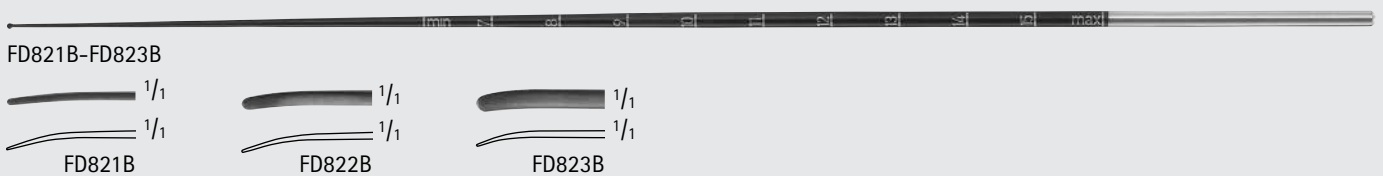

NEURO SURGERY

MIN, Noir Micro Raspatory F/ Modular Golfball Handle

Catalog Number	Tip	Tip Size (mm)	Length (in.)
FD831B	RING	DIAM. 1.0	7 7/8
FD832B	RING	DIAM. 2.0	7 7/8
FD833B	RING	DIAM. 3.0	7 7/8

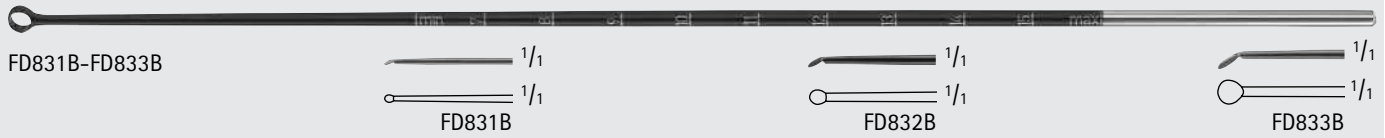

MIN, Noir Micro Tumor Knife F/ Modular Golfball Handle

Catalog Number	Tip	Tip Size (mm)	Length (in.)
FD839B	45°	DIAM. 1.5	7 7/8
FD840B	45°	DIAM. 3.0	7 7/8
FD841B	45°	DIAM. 4.5	7 7/8

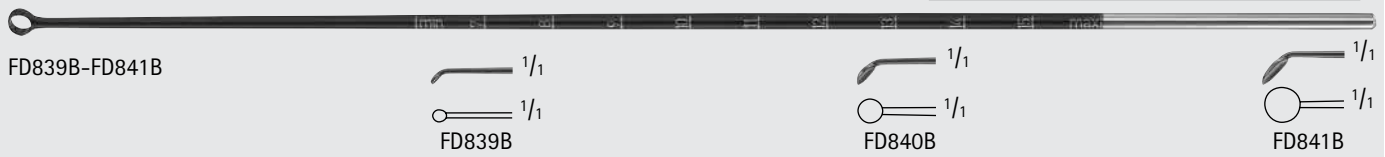

MIN, Noir Micro Curette F/ Modular Golfball Handle

Catalog Number	Tip	Diameter (mm)	Length (in.)
FD824B	0°	4.0	7 7/8
FD825B	45°	4.0	7 7/8
FD826B	90°	4.0	7 7/8
FD827B	45° W/ NECK	4.0	7 7/8
FD828B	90° W/ NECK	4.0	7 7/8
FD835B	45°	6.5	7 7/8
FD836B	90°	6.5	7 7/8

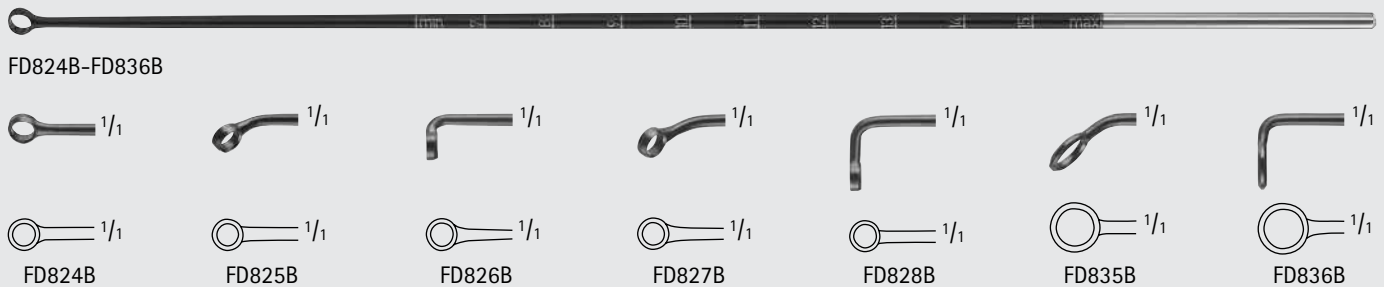

Storage Tray F/ MIN Micro Instruments

Catalog Number	Dimensions (mm)
FD467R	243 x 253 x 56



Neurosurgery

SENSATION™ Noir™ Micro Scissors, Bayonet-Shaped

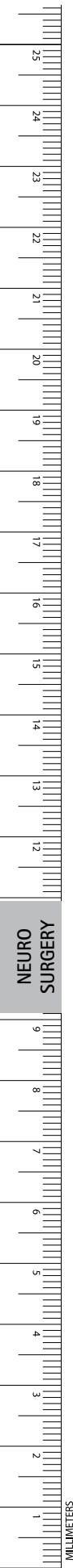

SENSATION Noir Micro Scissors

Catalog Number	Tip	Blade	Working Length (in.)	Length (in.)
FM146B	S/S	CVD-UP	2 3/8	7 1/4



SENSATION Noir Micro Scissors

Catalog Number	Tip	Blade	Working Length (in.)	Length (in.)
FM147B	S/S	CVD-UP	2 3/4	7 3/4

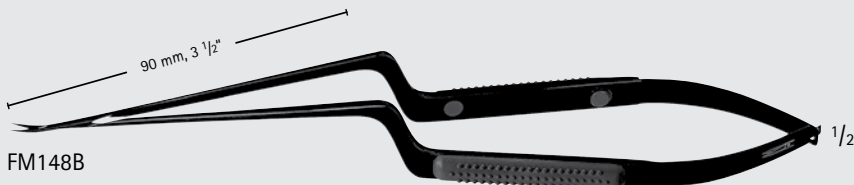

SENSATION Noir Micro Scissors

Catalog Number	Tip	Blade	Working Length (in.)	Length (in.)
FM148B	S/S	CVD-UP	3 1/2	8 1/2

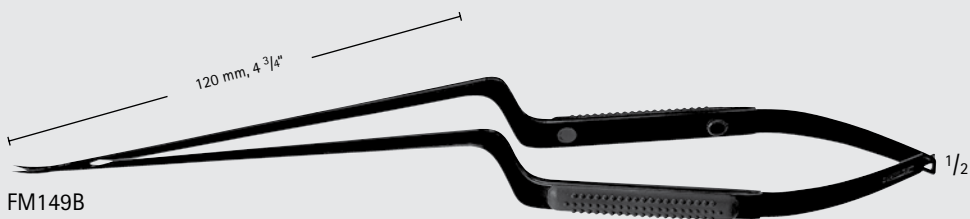

SENSATION Noir Micro Scissors

Catalog Number	Tip	Blade	Working Length (in.)	Length (in.)
FM149B	S/S	CVD-UP	4 3/4	9 5/8

NEURO SURGERY



SENSATION Micro Scissors

Catalog Number	Tip	Blade	Handle	Working Length (in.)	Length (in.)
FM120R	S/S	STR	BLUE	2 3/4	7 3/4
FM130R	S/B	STR	BLUE	2 3/4	7 3/4
FM140R	B/B	STR	BLUE	2 3/4	7 3/4

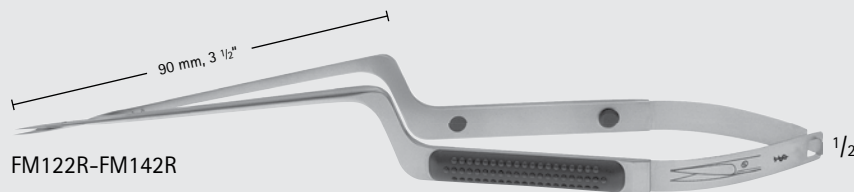
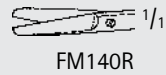
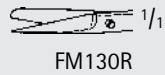
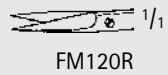

SENSATION Micro Scissors

Catalog Number	Tip	Blade	Handle	Working Length (in.)	Length (in.)
FM122R	S/S	STR	BLUE	3 1/2	8 1/2
FM132R	S/B	STR	BLUE	3 1/2	8 1/2
FM142R	B/B	STR	BLUE	3 1/2	8 1/2

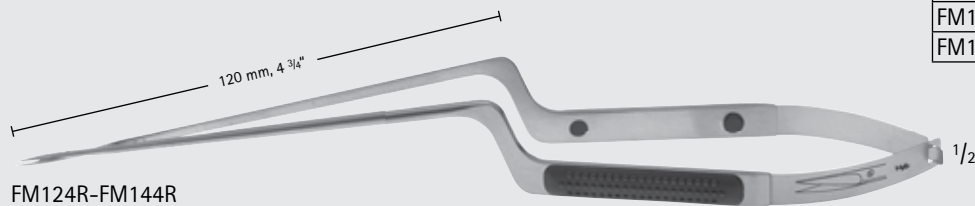
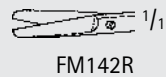
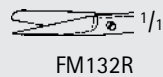
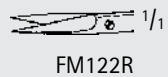

SENSATION Micro Scissors

Catalog Number	Tip	Blade	Handle	Working Length (in.)	Length (in.)
FM124R	S/S	STR	BLUE	4 3/4	9 5/8
FM134R	S/B	STR	BLUE	4 3/4	9 5/8
FM144R	B/B	STR	BLUE	4 3/4	9 5/8

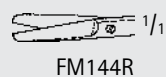
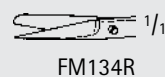
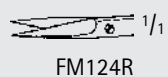

Neurosurgery

SENSATION™ Micro Scissors, Bayonet-Shaped

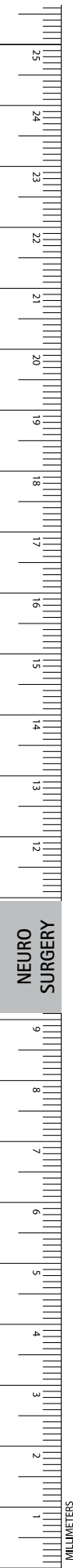

135 mm, 5 1/4"

FM159R-FM160R

1/1

1/1

FM159R

FM160R

1/2

SENSATION Micro Scissors

Catalog Number	Tip	Blade	Handle	Working Length (in.)	Length (in.)
FM159R	S/S	STR	BLUE	5 1/4	10 1/4
FM160R	B/B	STR	BLUE	5 1/4	10 1/4

70 mm, 2 3/4"

FM121R-FM141R

1/1

1/1

1/1

FM121R

FM131R

FM141R

1/2

SENSATION Micro Scissors

Catalog Number	Tip	Blade	Handle	Working Length (in.)	Length (in.)
FM121R	S/S	CVD-UP	BLUE	2 3/4	7 3/4
FM131R	S/B	CVD-UP	BLUE	2 3/4	7 3/4
FM141R	B/B	CVD-UP	BLUE	2 3/4	7 3/4

90 mm, 3 1/2"

FM123R-FM143R

1/1

1/1

1/1

FM123R

FM133R

FM143R

1/2

SENSATION Micro Scissors

Catalog Number	Tip	Blade	Handle	Working Length (in.)	Length (in.)
FM123R	S/S	CVD-UP	BLUE	3 1/2	8 1/2
FM133R	S/B	CVD-UP	BLUE	3 1/2	8 1/2
FM143R	B/B	CVD-UP	BLUE	3 1/2	8 1/2

NEURO SURGERY

SENSATION Micro Scissors

Catalog Number	Tip	Blade	Handle	Working Length (in.)	Length (in.)
FM125R	S/S	CVD-UP	BLUE	4 3/4	9 5/8
FM135R	S/B	CVD-UP	BLUE	4 3/4	9 5/8
FM145R	B/B	CVD-UP	BLUE	4 3/4	9 5/8

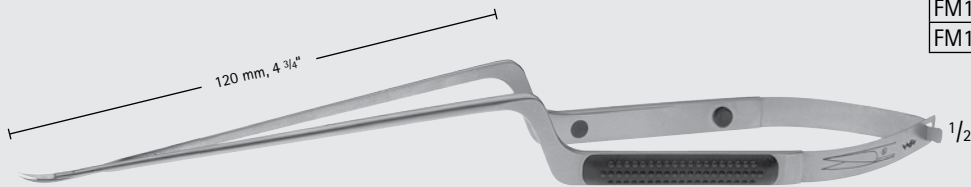

FM125R-FM145R

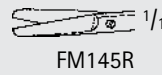
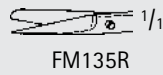
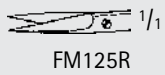

SENSATION Micro Scissors

Catalog Number	Tip	Blade	Handle	Working Length (in.)	Length (in.)
FM161R	S/S	CVD-UP	BLUE	5 1/4	10 1/4
FM162R	B/B	CVD-UP	BLUE	5 1/4	10 1/4

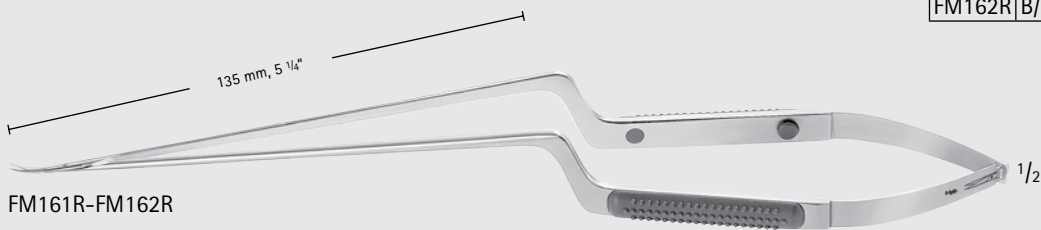

FM161R-FM162R

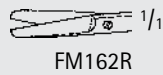
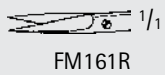

SENSATION Micro Scissors

Catalog Number	Tip	Blade	Handle	Working Length (in.)	Length (in.)
FM163R	S/S	CVD-DOWN	BLUE	3 1/2	8 1/2
FM164R	B/B	CVD-DOWN	BLUE	3 1/2	8 1/2

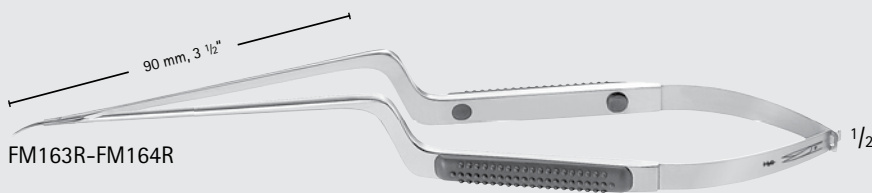

FM163R-FM164R

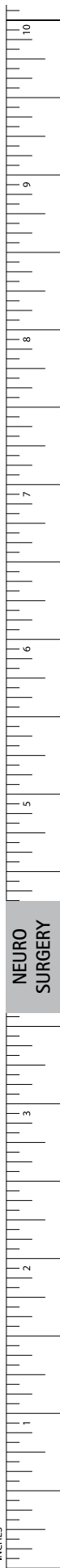
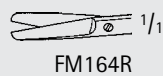
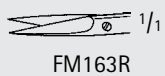

Neurosurgery

SENSATION™ Micro Scissors, Bayonet-Shaped

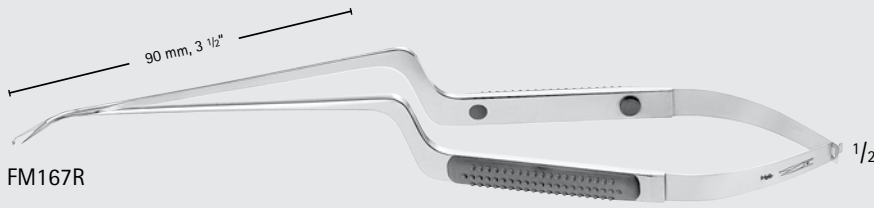

FM167R



FM167R

SENSATION Micro Scissors

Catalog Number	Tip	Blade	Handle	Working Length (in.)	Length (in.)
FM167R	1 BALL-POINT	45° LATERAL ANG	BLUE	3 1/2	8 1/2

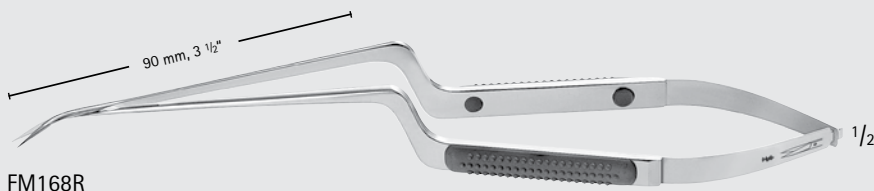

FM168R



FM168R

SENSATION Micro Scissors

Catalog Number	Tip	Blade	Handle	Working Length (in.)	Length (in.)
FM168R	B/B	45° LATERAL ANG	BLUE	3 1/2	8 1/2

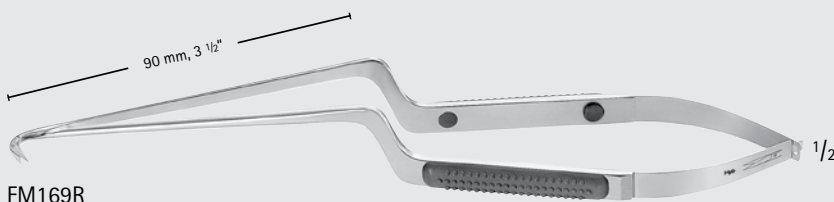

FM169R



FM169R

SENSATION Micro Scissors

Catalog Number	Tip	Blade	Handle	Working Length (in.)	Length (in.)
FM169R	B/B	125° LATERAL ANG	BLUE	3 1/2	8 1/2

NEURO SURGERY

Neurosurgery

SENSATION™ Micro Forceps, Bayonet-Shaped

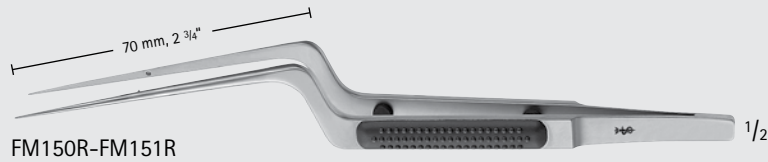

FM150R-FM151R

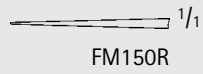

FM150R

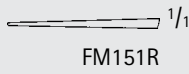

FM151R

SENSATION Micro Forceps

Catalog Number	Tip Size (mm)	Handle	Working Length (in.)	Length (in.)
FM150R	0.5	BLACK	2 3/4	7 1/2
FM151R	0.9	BLACK	2 3/4	7 1/2

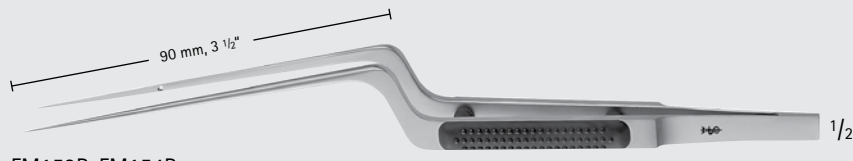

FM153R-FM154R

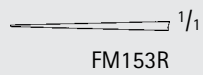

FM153R

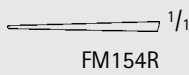

FM154R

SENSATION Micro Forceps

Catalog Number	Tip Size (mm)	Handle	Working Length (in.)	Length (in.)
FM153R	0.5	BLACK	3 1/2	8 1/4
FM154R	0.9	BLACK	3 1/2	8 1/4

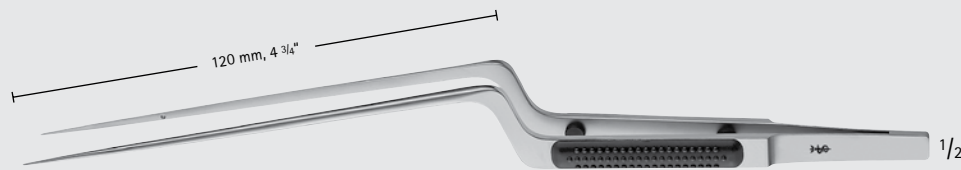

FM156R-FM157R

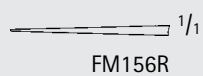

FM156R

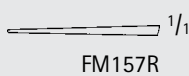

FM157R

SENSATION Micro Forceps

Catalog Number	Tip Size (mm)	Handle	Working Length (in.)	Length (in.)
FM156R	0.5	BLACK	4 3/4	9 1/2
FM157R	0.9	BLACK	4 3/4	9 1/2

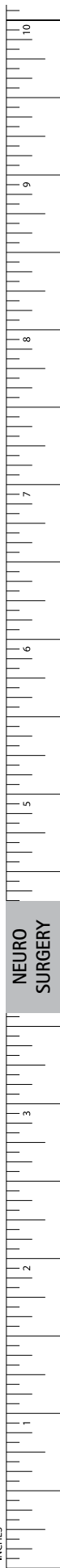

Neurosurgery

SENSATION™ Tumor Grasper, Bayonet-Shaped

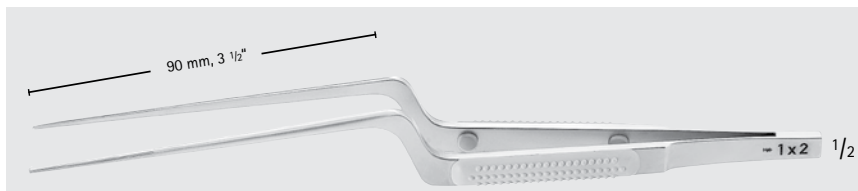
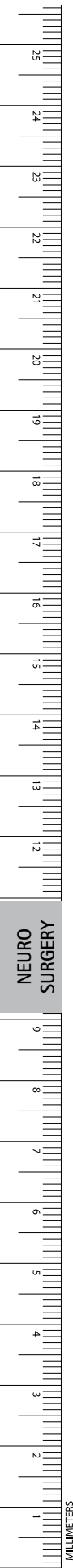

FM174R



FM174R

SENSATION Tumor Grasper

Catalog Number	Jaw	Teeth	Handle	Working Length (in.)	Length (in.)
FM174R	THIN TOOTH	1 x 2	YELLOW	3 1/2	8 1/4

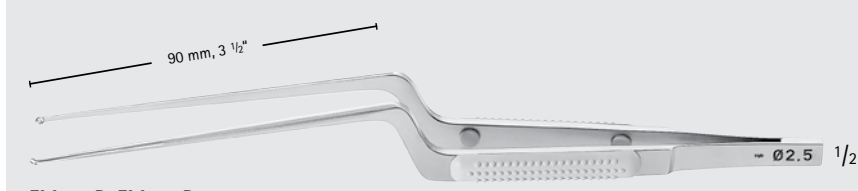

FM176R-FM177R



FM176R-FM177R

SENSATION Tumor Grasper

Catalog Number	Jaw	Jaw Size (mm)	Handle	Working Length (in.)	Length (in.)
FM176R	SERR	DIAM. 2.5	YELLOW	3 1/2	8 1/4
FM177R	SERR	DIAM. 3.5	YELLOW	3 1/2	8 1/4

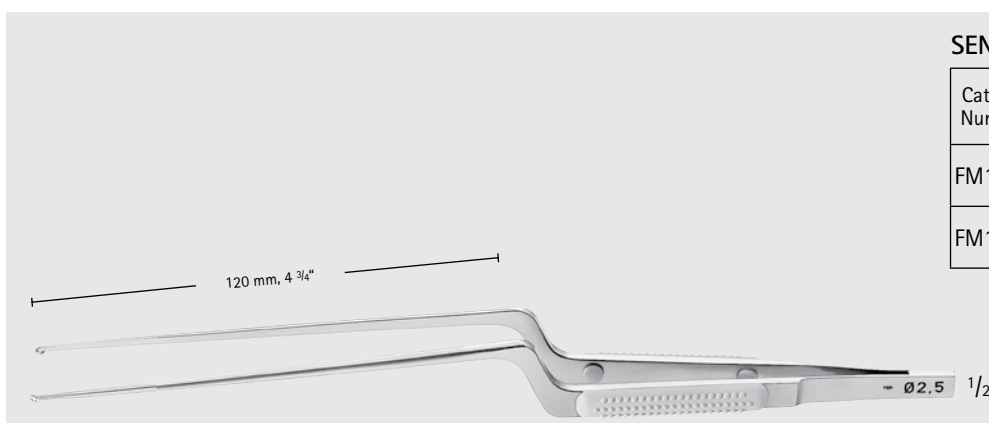

FM178R-FM179R



FM178R-FM179R

SENSATION Tumor Grasper

Catalog Number	Jaw	Jaw Size (mm)	Handle	Working Length (in.)	Length (in.)
FM178R	SERR	DIAM. 2.5	YELLOW	4 3/4	9 1/2
FM179R	SERR	DIAM. 3.5	YELLOW	4 3/4	9 1/2

NEURO SURGERY

70 mm, 2 3/4"

FM170R

1/2

1/1

FM170R

SENSATION Micro Needle Holder

Catalog Number	Jaw Size (mm)	Handle	Working Length (in.)	Length (in.)
FM170R	0.5	GREEN	2 3/4	7 3/4

90 mm, 3 1/2"

FM173R

1/2

1/1

FM173R

SENSATION Micro Needle Holder

Catalog Number	Jaw Size (mm)	Handle	Working Length (in.)	Length (in.)
FM173R	0.5	GREEN	3 1/2	8 1/2

120 mm, 4 3/4"

FM175R

1/2

1/1

FM175R

SENSATION Micro Needle Holder

Catalog Number	Jaw Size (mm)	Handle	Working Length (in.)	Length (in.)
FM175R	2.5	GREEN	4 3/4	9 5/8

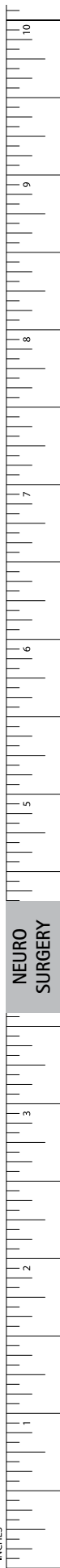

Neurosurgery

XS Micro Scissors, Bayonet-Shaped

XS Micro Scissors

Catalog Number	Tip	Blade	Item	Working Length (in.)	Length (in.)
FM670R	S/S	STR	COMPLETE	2 3/4	7 7/8
FM675R	S/S	STR	JAW INSERT	2 3/4	-
FM690R	B/B	STR	COMPLETE	2 3/4	7 7/8
FM695R	B/B	STR	JAW INSERT	2 3/4	-
FM730R	-	-	HANDLE	-	-

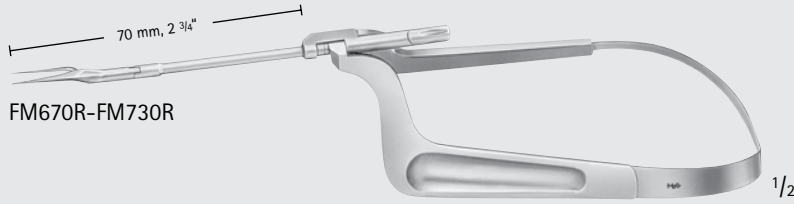

XS Micro Scissors

Catalog Number	Tip	Blade	Item	Working Length (in.)	Length (in.)
FM671R	S/S	STR	COMPLETE	4	9
FM676R	S/S	STR	JAW INSERT	4	-
FM691R	B/B	STR	COMPLETE	4	9
FM696R	B/B	STR	JAW INSERT	4	-
FM731R	-	-	HANDLE	-	-

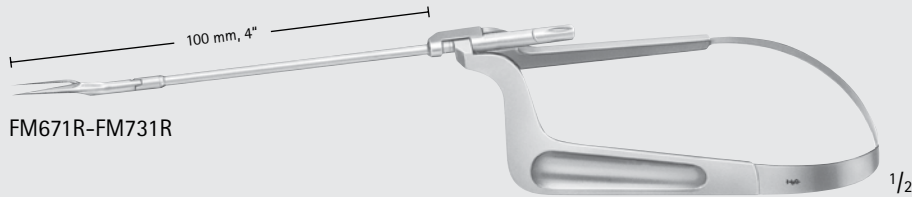

XS Micro Scissors

Catalog Number	Tip	Blade	Item	Working Length (in.)	Length (in.)
FM672R	S/S	STR	COMPLETE	5 1/8	10 1/4
FM677R	S/S	STR	JAW INSERT	5 1/8	-
FM692R	B/B	STR	COMPLETE	5 1/8	10 1/4
FM697R	B/B	STR	JAW INSERT	5 1/8	-
FM732R	-	-	HANDLE	-	-

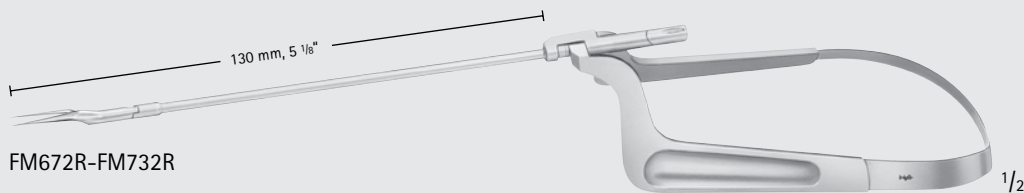

Neurosurgery

XS Micro Scissors, Bayonet-Shaped

XS Micro Scissors

Catalog Number	Tip	Blade	Item	Working Length (in.)	Length (in.)
FM680R	S/S	CVD	COMPLETE	2 3/4	7 7/8
FM685R	S/S	CVD	JAW INSERT	2 3/4	-
FM700R	B/B	CVD	COMPLETE	2 3/4	7 7/8
FM705R	B/B	CVD	JAW INSERT	2 3/4	-
FM730R	-	-	HANDLE	-	-

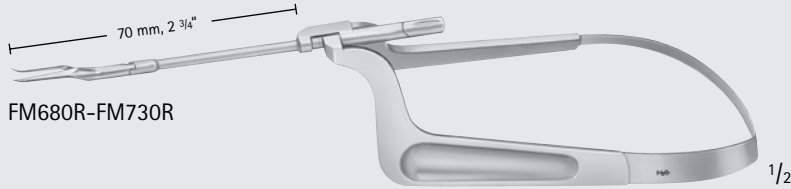

XS Micro Scissors

Catalog Number	Tip	Blade	Item	Working Length (in.)	Length (in.)
FM681R	S/S	CVD	COMPLETE	4	9
FM686R	S/S	CVD	JAW INSERT	4	-
FM701R	B/B	CVD	COMPLETE	4	9
FM706R	B/B	CVD	JAW INSERT	4	-
FM731R	-	-	HANDLE	-	-

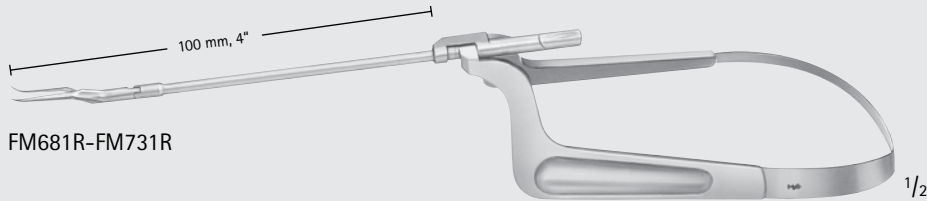

XS Micro Scissors

Catalog Number	Tip	Blade	Item	Working Length (in.)	Length (in.)
FM682R	S/S	CVD	COMPLETE	5 1/8	10 1/4
FM687R	S/S	CVD	JAW INSERT	5 1/8	-
FM702R	B/B	CVD	COMPLETE	5 1/8	10 1/4
FM707R	B/B	CVD	JAW INSERT	5 1/8	-
FM732R	-	-	HANDLE	-	-

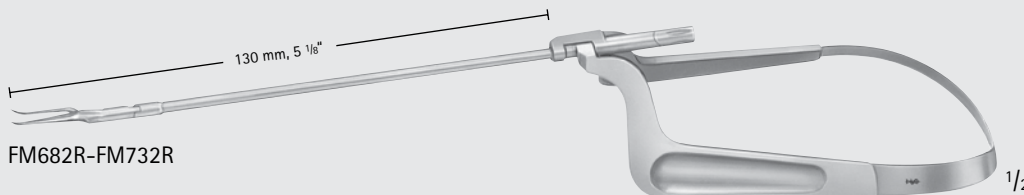

NEURO SURGERY

INCHES

Neurosurgery

XS Micro Forceps, Bayonet-Shaped

XS Micro Forceps

Catalog Number	Jaw Size (mm)	Item	Working Length (in.)	Length (in.)
FM710R	0.9	COMPLETE	2 3/4	7 7/8
FM715R	0.9	JAW INSERT	2 3/4	-
FM730R	-	HANDLE	-	-

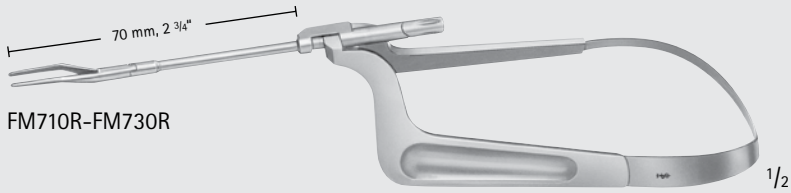

XS Micro Forceps

Catalog Number	Jaw Size (mm)	Item	Working Length (in.)	Length (in.)
FM711R	0.9	COMPLETE	4	9
FM716R	0.9	JAW INSERT	4	-
FM731R	-	HANDLE	-	-

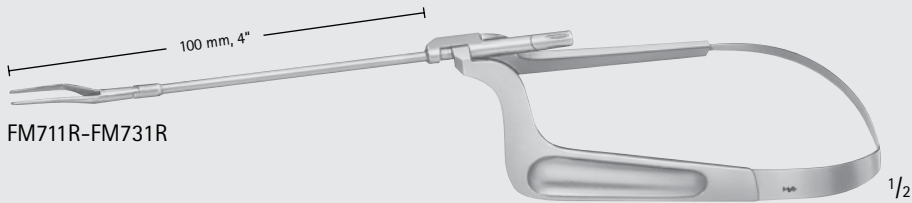

XS Micro Forceps

Catalog Number	Jaw Size (mm)	Item	Working Length (in.)	Length (in.)
FM712R	0.9	COMPLETE	5 1/8	10 1/4
FM717R	0.9	JAW INSERT	5 1/8	-
FM732R	-	HANDLE	-	-

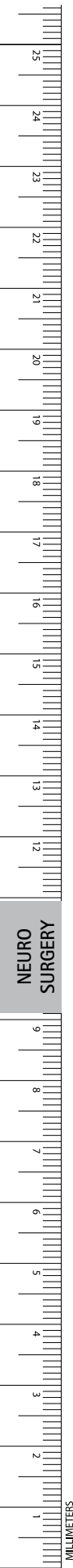
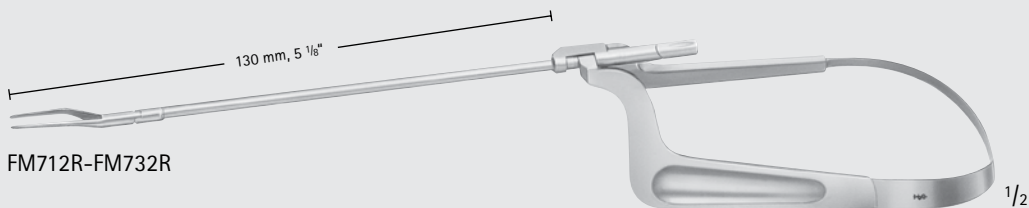

NEURO SURGERY

Neurosurgery

XS Micro Forceps, Bayonet-Shaped

XS Micro Tumor Grasping Forceps

Catalog Number	Jaw Size (mm)	Jaw	Item	Working Length (in.)	Length (in.)
FM720R	3.0	SHARP	COMPLETE	2 3/4	7 7/8
FM725R	3.0	SHARP	JAW INSERT	2 3/4	-
FM730R	-	-	HANDLE	-	-

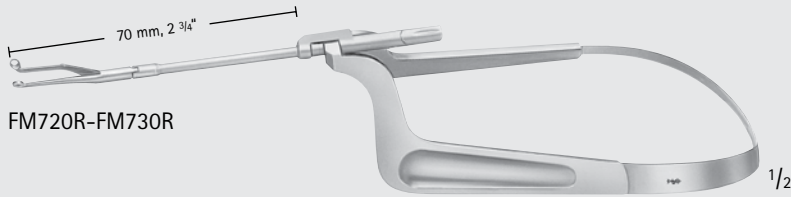

XS Micro Tumor Grasping Forceps

Catalog Number	Jaw Size (mm)	Jaw	Item	Working Length (in.)	Length (in.)
FM721R	3.0	SHARP	COMPLETE	4	9
FM726R	3.0	SHARP	JAW INSERT	4	-
FM731R	-	-	HANDLE	-	-

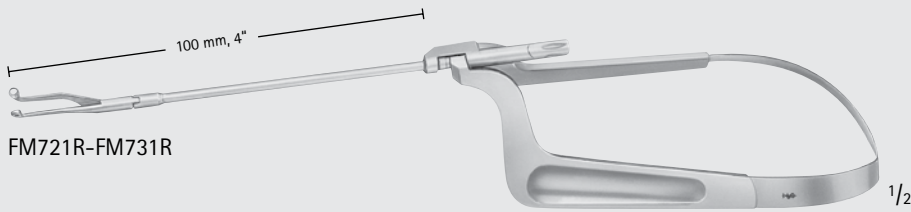

XS Micro Tumor Grasping Forceps

Catalog Number	Jaw Size (mm)	Jaw	Item	Working Length (in.)	Length (in.)
FM722R	3.0	SHARP	COMPLETE	5 1/8	10 1/4
FM727R	3.0	SHARP	JAW INSERT	5 1/8	-
FM732R	-	-	HANDLE	-	-

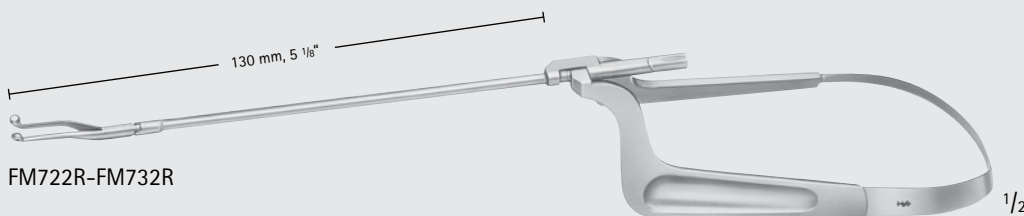

NEURO SURGERY

INCHES

Neurosurgery

XS Micro Forceps

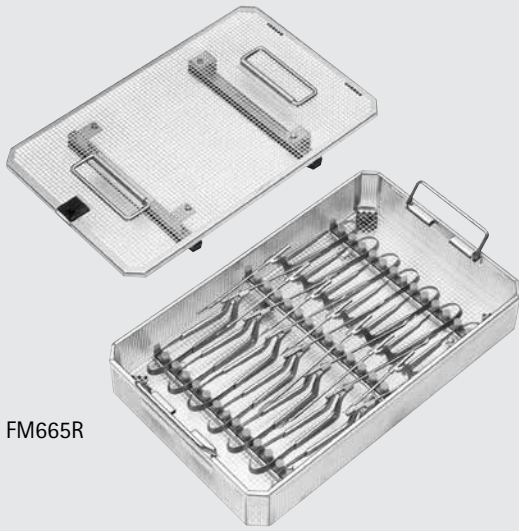

FM665R

Storage Tray for Micro Instruments, W/ Instruments Racks

Catalog Number	Compatible w/	Dimensions (mm)
FM665R	SENSATION AND XS MICRO- INSTRUMENTS	406 x 253 x 76

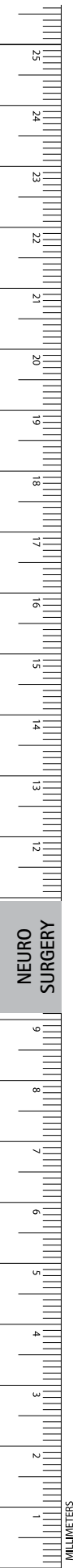

Neurosurgery

EC/IC Bypass Instruments - Noir™ Scissors

EC/IC Bypass Instruments, Noir Scissors

Catalog Number	Tip	Blade	Shape	Working Length (in.)	Length (in.)
FD482B	S/S	CVD	STR	2	5 1/2
FD481B	B/S	CVD	STR	2	5 1/2
FD483B	S/S	CVD	STR	3 1/8	6 3/4
FD484B	S/S	CVD	BAYONET	4	8 7/8
FD485B	B/S	CVD	BAYONET	4	8 7/8



FD481B-FD482B



FD481B



FD482B

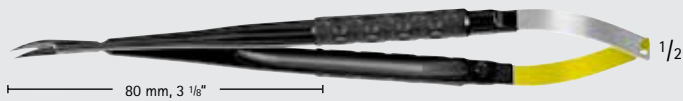

FD483B



FD483B

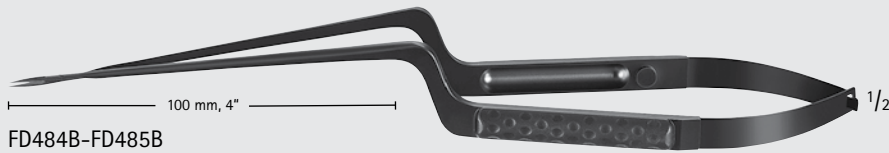

FD484B-FD485B



FD484B



FD485B

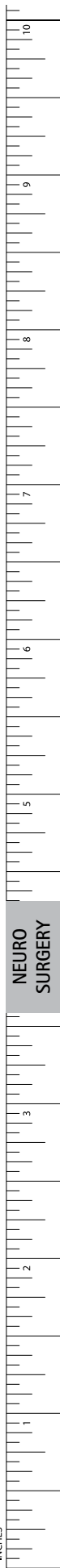

NEURO SURGERY

INCHES

Neurosurgery

EC/IC Bypass Instruments - Noir™ Forceps



FD488B



FD488B



FD489B



FD489B



FD490B



FD490B

EC/IC Bypass Instruments, Noir Forceps

Catalog Number	Tip	Tip Size (mm)	Working Length (in.)	Length (in.)
FD488B	STR	0.3	2	5 1/2
FD489B	STR	0.3	3 1/8	6 3/4
FD490B	STR	0.3	4	8 1/4

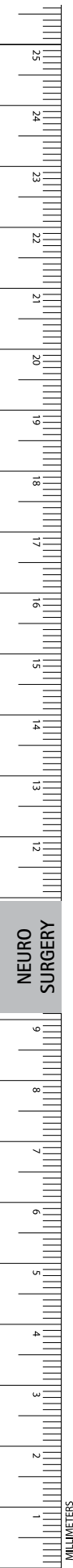

NEURO SURGERY

EC/IC Bypass Instruments - Noir™ Needle Holders/Noir™ Bypass Vessel Punch/Storage Rack

EC/IC Bypass Instruments, Noir Needle Holder

Catalog Number	Tip	Tip Size (mm)	Working Length (in.)	Length (in.)
FD493B	STR	0.5	2	6
FD494B	CVD	0.5	3 1/8	6 3/4
FD495B	CVD	0.5	4	8 1/4

EC/IC Bypass Instruments, Noir Bypass Vessel Punch

Catalog Number	Working Length (in.)	Length (in.)
FB194B	2	5 1/2

Storage Rack F/ EC/IC Bypass Instruments

Catalog Number	Dimensions (mm)
FD460R	410 x 257 x 56



NEURO SURGERY

INCHES

Neurosurgery

Skull Base Instruments

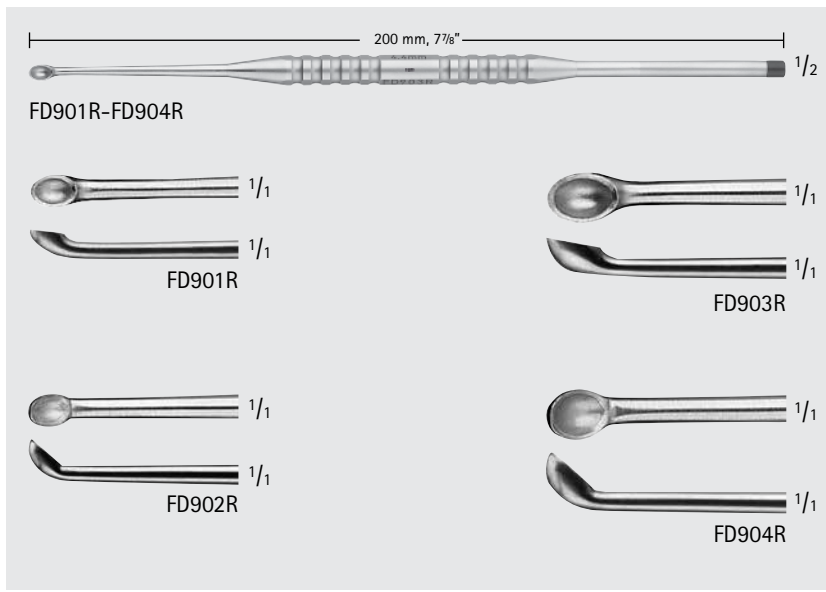
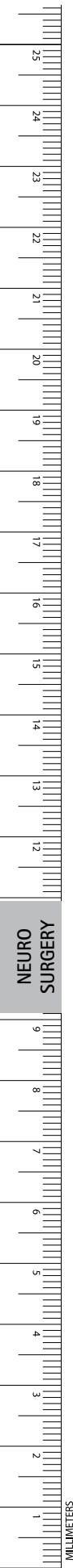

AL-MEFTY Spoon

Catalog Number	Tip	Tip Size (mm)	Handle	Length (in.)
FD901R	STR, SHARP	2.8	BLACK CAP	7 7/8
FD902R	ANG, SHARP	2.8	BLACK CAP	7 7/8
FD903R	STR, SHARP	4.4	BLACK CAP	7 7/8
FD904R	ANG, SHARP	4.4	BLACK CAP	7 7/8

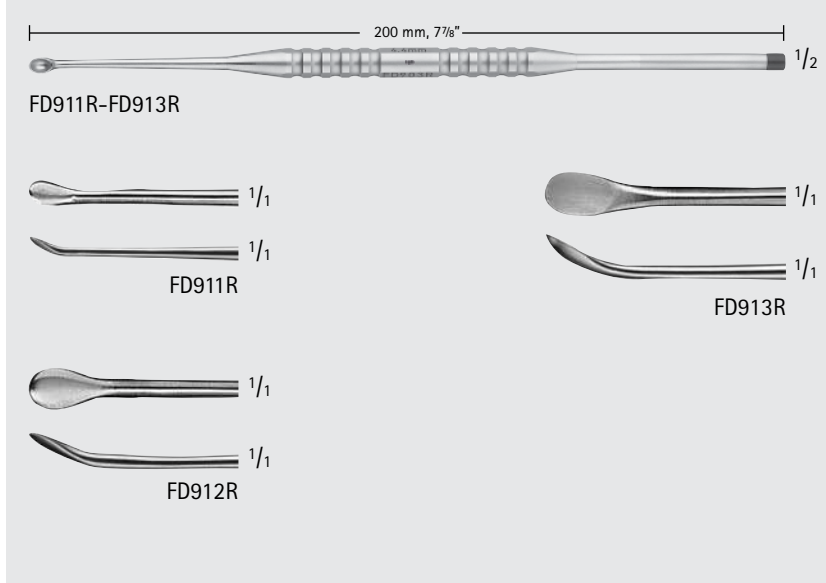

AL-MEFTY Dissector

Catalog Number	Tip	Tip Size (mm)	Handle	Length (in.)
FD911R	ANG, SHARP	2.0	BLACK CAP	7 7/8
FD912R	ANG, SHARP	3.5	BLACK CAP	7 7/8
FD913R	ANG, SHARP	4.0	BLACK CAP	7 7/8

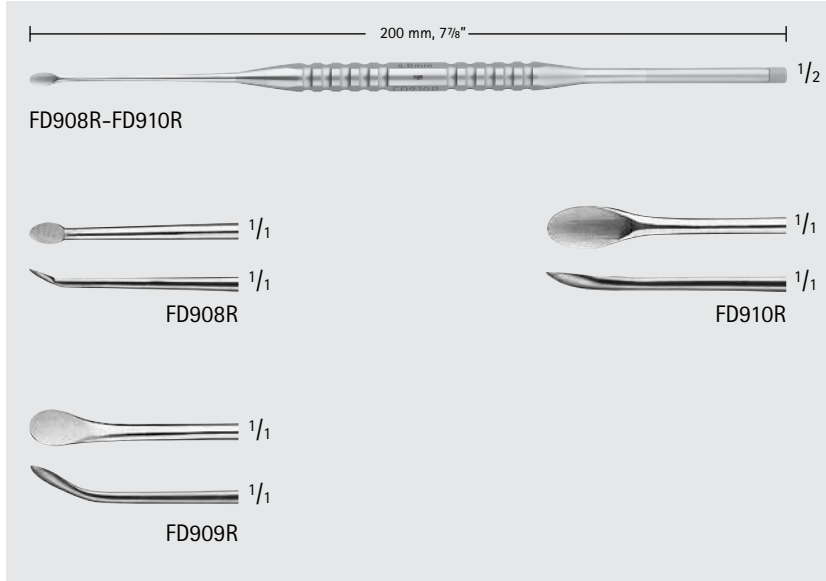

AL-MEFTY Dissector

Catalog Number	Tip	Tip Size (mm)	Handle	Length (in.)
FD908R	ANG, SEMI-SHARP	2.0	GREY CAP	7 7/8
FD909R	ANG, SEMI-SHARP	3.5	GREY CAP	7 7/8
FD910R	STR, SEMI-SHARP	4.0	GREY CAP	7 7/8



FD905R

AL-MEFTY Ligature Needle

Catalog Number	Tip	Length (in.)
FD905R	MALLEABLE	7 1/2

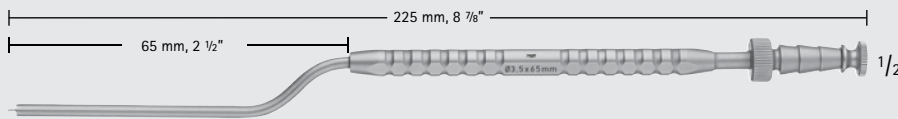

FD906R

AL-MEFTY Suction Cannula

Catalog Number	Working Length (in.)	Diameter (mm)	Length (in.)
FD906R	2 1/2	3.5	8 7/8

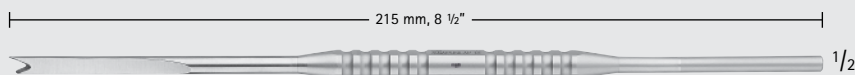

FD907R

AL-MEFTY Chisel

Catalog Number	Tip Size (mm)	Length (in.)
FD907R	5.0	8 1/2

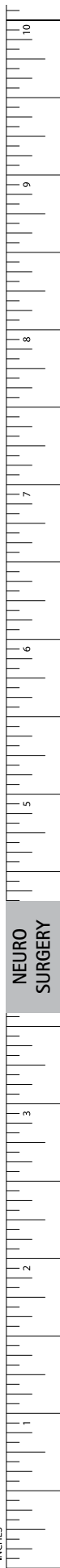

Neurosurgery

Micro Dissectors/Rasps/Hooks

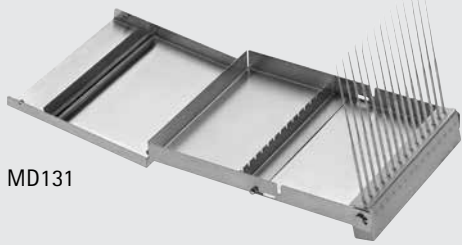

Micro Dissector Set

Catalog Number	Description
MD131	COMPLETE SET

Set Includes:

- 1 Micro dissector storage case MD132R
- 1 Instrument of each MD133-MD148



Micro Dissector Storage Case

Catalog Number	Dimension (in.)
MD132	10.869 x 8.115 x 0.944



Expanded Micro Dissector Storage Case

Catalog Number	Dimension (in.)
MF363R	10.869 x 10.074 x 0.944



Expanded Micro Dissector Set

Catalog Number	Description
MF364R	COMPLETE SET

Set Includes:

- 1 Expanded micro dissector storage case MF363R
- 1 Instrument of each MD133-MD148, MF360R-MF362R

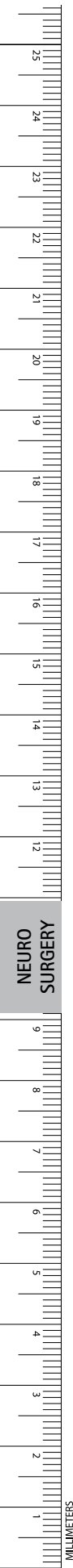

NEURO SURGERY

Neurosurgery

Micro Dissectors/Rasps/Hooks

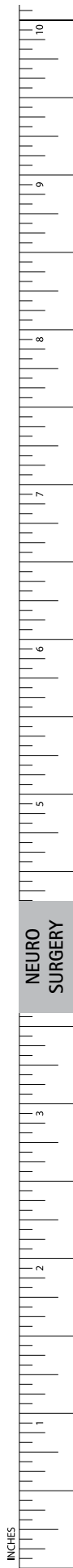

MD133 1/2

1/1

1/1

MD133

Micro Dissector, Round

Catalog Number	Tip Size (mm)	Length (in.)
MD133	1.0	7 1/2

MD134 1/2

1/1

1/1

MD134

Micro Dissector, Round

Catalog Number	Tip Size (mm)	Length (in.)
MD134	2.0	7 1/2

MD135 1/2

1/1

1/1

MD135

Micro Dissector, Round

Catalog Number	Tip Size (mm)	Length (in.)
MD135	3.0	7 1/2

MD136 1/2

1/1

1/1

MD136

Micro Elevator

Catalog Number	Tip	Length (in.)
MD136	CVD	7 1/2

MD137 1/2

1/1

1/1

MD137

Micro Dissector Elevator

Catalog Number	Tip	Length (in.)
MD137	ANG	7 1/2

MD138 1/2

1/1

1/1

MD138

Micro Spatula Dissector

Catalog Number	Tip	Length (in.)
MD138	SMALL	7 1/2

Neurosurgery

Micro Dissectors/Rasps/Hooks

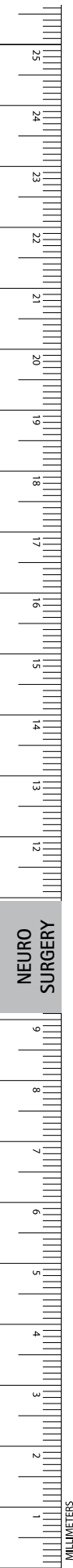

MD139

MD139

MD139

Micro Spatula Dissector

Catalog Number	Tip	Length (in.)
MD139	MEDIUM	7 1/2

MD140

MD140

MD140

Micro Spatula Dissector

Catalog Number	Tip	Length (in.)
MD140	LARGE	7 1/2

MD141

MD141

MD141

Micro Hook

Catalog Number	Tip	Length (in.)
MD141	90°, SEMI-SHARP	7 1/2

MD142

MD142

MD142

Micro Hook

Catalog Number	Tip	Length (in.)
MD142	90°, BLUNT	7 1/2

MD143

MD143

MD143

Micro Needle Dissector

Catalog Number	Tip	Length (in.)
MD143	45°, SEMI-SHARP	7 1/2

MD144

MD144

MD144

Micro Needle Dissector

Catalog Number	Tip	Length (in.)
MD144	STR, SEMI-SHARP	7 1/2

Neurosurgery

Micro Dissectors/Rasps/Hooks





MD145 1/2



MD145 1/1

Micro Curette

Catalog Number	Tip	Tip Size (mm)	Length (in.)
MD145	STR	1 x 2	7 1/2



MD146 1/2



MD146 1/1

Micro Curette

Catalog Number	Tip	Tip Size (mm)	Length (in.)
MD146	ANG	1 x 2	7 1/2



MD147 1/2

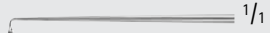

MD147 1/1

Micro Ball Dissector

Catalog Number	Tip	Tip Size (mm)	Length (in.)
MD147	90°	3.0	7 1/2



MD148 1/2

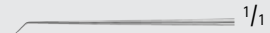

MD148 1/1

Micro Ball Dissector

Catalog Number	Tip	Tip Size (mm)	Length (in.)
MD148	45°	4.0	7 1/2

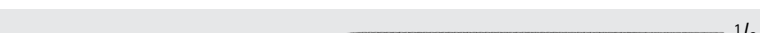

MF360R 1/2

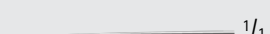

MF360R 1/1

Micro Ball Dissector

Catalog Number	Tip	Tip Size (mm)	Length (in.)
MF360R	90°	5.0	7 1/2

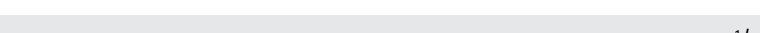

MF361R 1/2

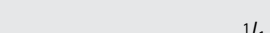

MF361R 1/1

Micro Ball Dissector

Catalog Number	Tip	Tip Size (mm)	Length (in.)
MF361R	45°	8.0	7 1/2

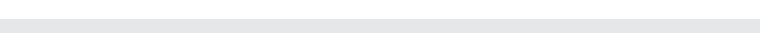

MF362R 1/2

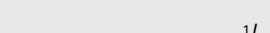

MF362R 1/1

Micro Ball Dissector

Catalog Number	Tip	Tip Size (mm)	Length (in.)
MF362R	STR	0.8	7 1/2

Neurosurgery

Micro Dissectors/Rasps/Hooks

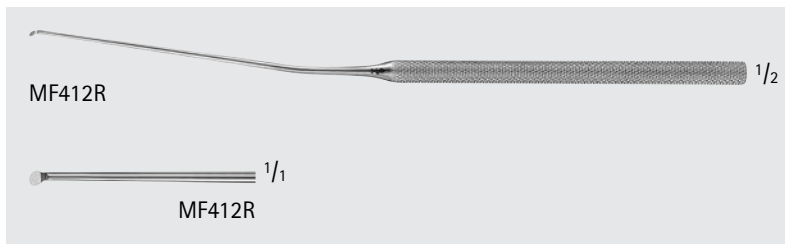
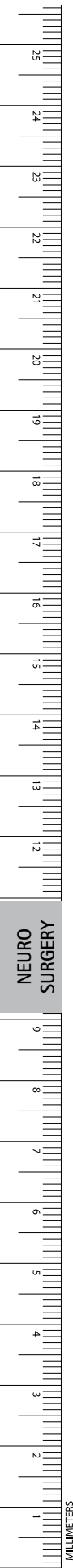

Jannetta Style Knife #1

Catalog Number	Diameter (mm)	Length (in.)
MF412R	2.0	7 1/2

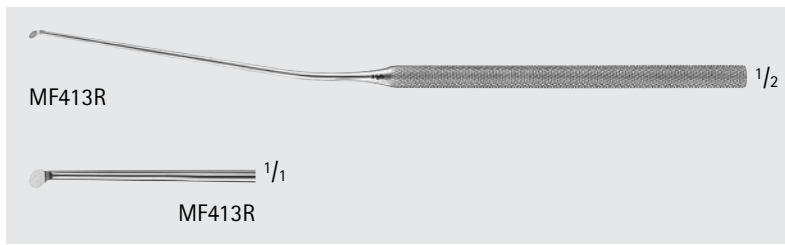

Jannetta Style Knife #2

Catalog Number	Diameter (mm)	Length (in.)
MF413R	2.5	7 1/2

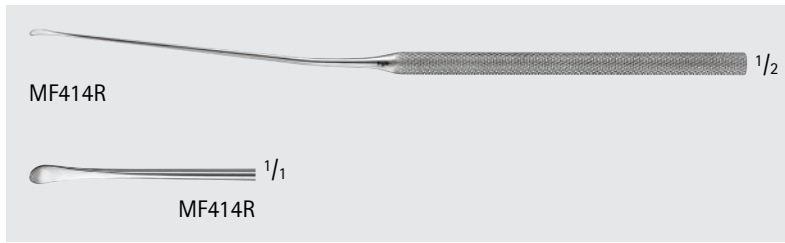

Jannetta Style Duckbill Elevator #3

Catalog Number	Width (mm)	Length (in.)
MF414R	2.7	7 1/2

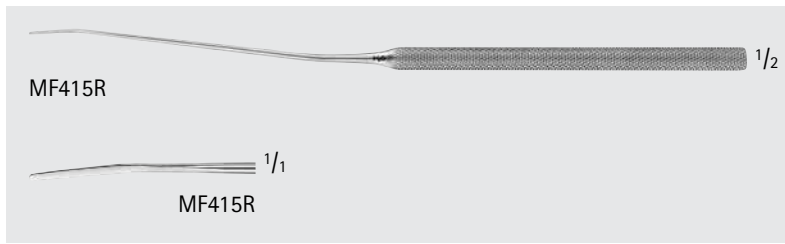

Jannetta Style Elevator #4

Catalog Number	Width (mm)	Length (in.)
MF415R	1.2	7 1/2

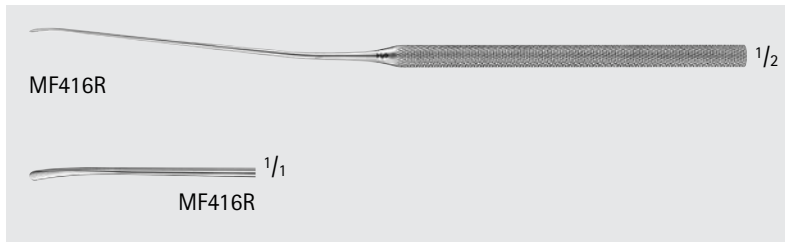

Jannetta Style Dissector #5

Catalog Number	Width (mm)	Length (in.)
MF416R	1.6	7 1/2

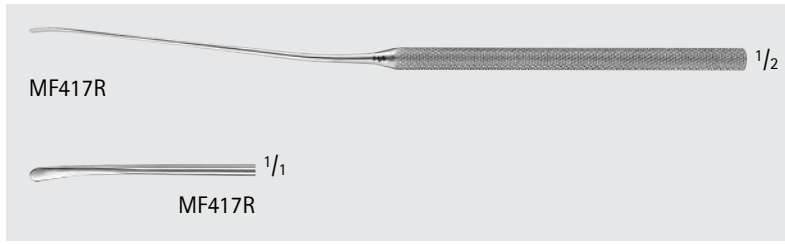

Jannetta Style Dissector #6

Catalog Number	Width (mm)	Length (in.)
MF417R	2.0	7 1/2

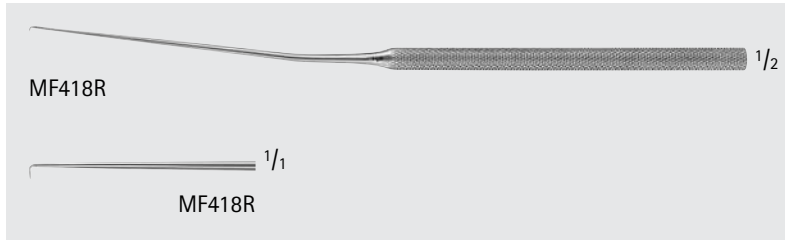

Jannetta Style Right Angle Hook #7

Catalog Number	Tip	Tip Size (mm)	Length (in.)
MF418R	90°	2.0	7 1/2

Neurosurgery

Micro Dissectors/Rasps/Hooks





MF419R 1/2

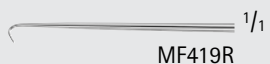

MF419R 1/1

Jannetta Style Probe #8

Catalog Number	Tip	Tip Size (mm)	Length (in.)
MF419R	45°	1.7	7 1/2



MF420R 1/2

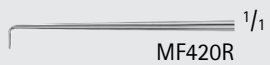

MF420R 1/1

Jannetta Style Right Angle Hook #9

Catalog Number	Tip	Tip Size (mm)	Length (in.)
MF420R	90°	3.5	7 1/2



MF421R 1/2

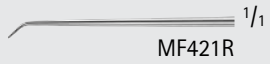

MF421R 1/1

Jannetta Style Hook #9A

Catalog Number	Tip	Tip Size (mm)	Length (in.)
MF421R	45°	2.8	7 1/2



MF422R 1/2



MF422R 1/1

Jannetta Style Right Angle Hook #10

Catalog Number	Tip	Tip Size (mm)	Length (in.)
MF422R	90°	4.7	7 1/2



MF423R 1/2

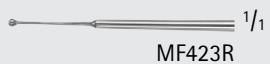

MF423R 1/1

Jannetta Style Probe #11

Catalog Number	Tip	Diameter (mm)	Length (in.)
MF423R	BALL-PT	0.8	7 1/2



MF424R 1/2



MF424R 1/1

Jannetta Style Double Prong Fork #12

Catalog Number	Tip	Width (mm)	Length (in.)
MF424R	30°	1.1	7 1/2



MF425R 1/2

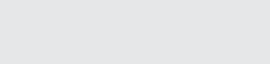

MF425R 1/1

Jannetta Style Double Prong Fork #13

Catalog Number	Tip	Width (mm)	Length (in.)
MF425R	30°	1.4	7 1/2

INCHES

Neurosurgery

Micro Dissectors/Rasps/Hooks

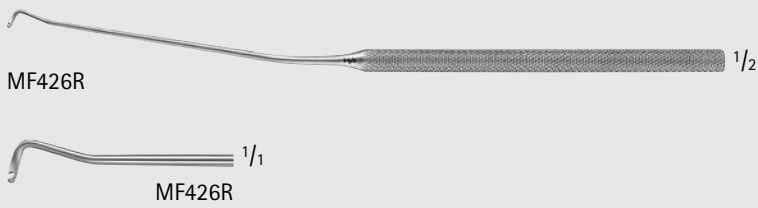

Jannetta Style Aneurysm Neck Dissector #14

Catalog Number	Tip	Length (in.)
MF426R	RIGHT	7 1/2

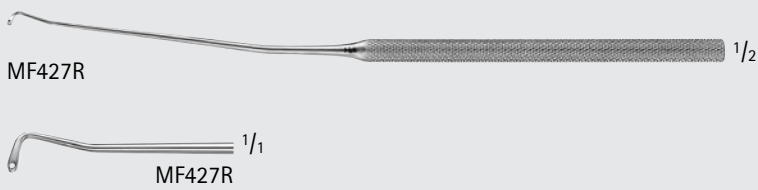

Jannetta Style Aneurysm Neck Dissector #15

Catalog Number	Tip	Length (in.)
MF427R	RIGHT	7 1/2

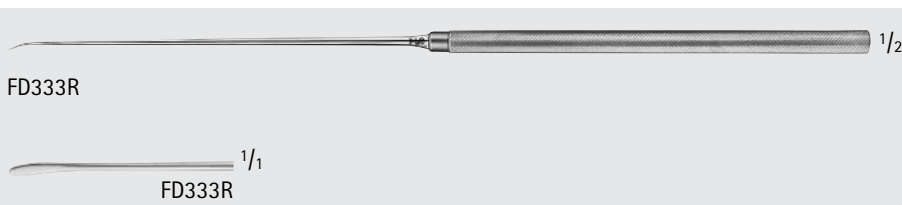

Micro Dissector

Catalog Number	Length (in.)
FD333R	9

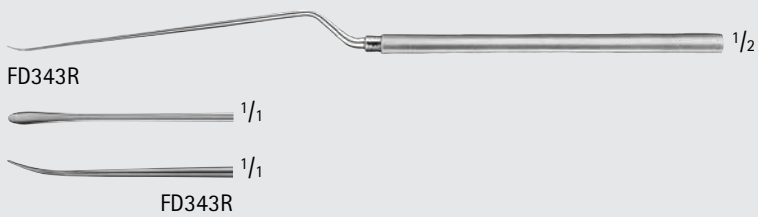

Micro Dissector

Catalog Number	Tip	Shape	Length (in.)
FD343R	CVD-UP	BAYONET	9

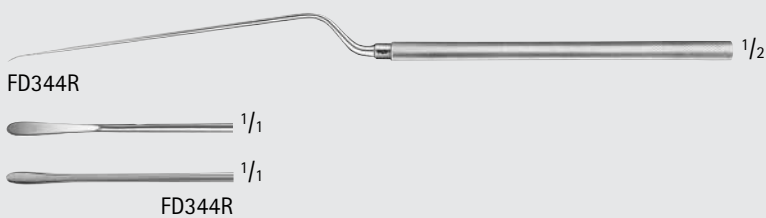

Micro Dissector

Catalog Number	Tip	Shape	Length (in.)
FD344R	CVD	BAYONET	9



Micro Raspatory

Catalog Number	Tip	Length (in.)
FD338R	PLATE-SHAPED ANG-DOWN	9

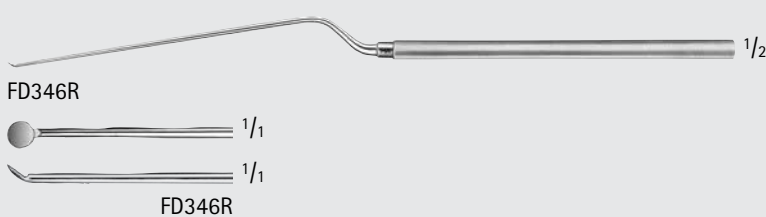

Micro Raspatory

Catalog Number	Tip	Shape	Length (in.)
FD346R	PLATE-SHAPED ANG-UP	BAYONET	9

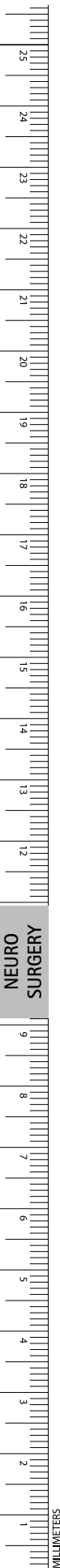

NEURO SURGERY

Neurosurgery

Micro Dissectors/Rasps/Hooks

FD330R  1/2

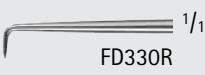
 1/1
FD330R

Catalog Number	Tip	Length (in.)
FD330R	SEMI-SHARP	9

FD331R  1/2

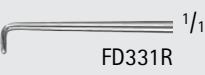
 1/1
FD331R

Catalog Number	Tip	Length (in.)
FD331R	BLUNT	9

FD332R  1/2

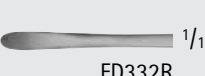
 1/1
FD332R

Catalog Number	Tip	Length (in.)
FD332R	STR	9

FD334R  1/2

 1/1
FD334R

Catalog Number	Tip	Length (in.)
FD334R	SMALL	9

FD335R  1/2

 1/1
FD335R

Catalog Number	Tip	Length (in.)
FD335R	STR, SHARP	9

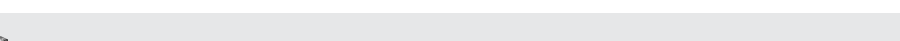
FD336R  1/2

 1/1
FD336R

Catalog Number	Tip	Length (in.)
FD336R	ANG, SHARP	9

FD337R  1/2

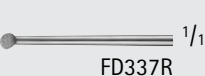
 1/1
FD337R

Catalog Number	Tip	Length (in.)
FD337R	ROUND, SMALL	9



NEURO SURGERY

INCHES

Neurosurgery

Micro Dissectors/Rasps/Hooks



FF326R

YASARGIL Dissector, F/ Pediatrics

Catalog Number	Tip Size (mm)	Shaft	Length (in.)
FF326R	4.0	FLEX	7 3/4



FF327R

YASARGIL Dissector, F/ Adults

Catalog Number	Tip Size (mm)	Shaft	Length (in.)
FF327R	7.0	FLEX	7 3/4



FF291R

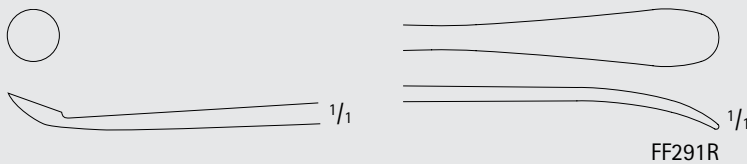

PENFIELD Dissector, Double Ended

Catalog Number	Tip	Size	Length (in.)
FF291R	SLIGHT-CVD, S/B	#1	6 7/8



FF292R



PENFIELD Dissector, Double Ended

Catalog Number	Tip	Size	Length (in.)
FF292R	SLIGHT-CVD, S/B	#2	7 3/4



FF293R

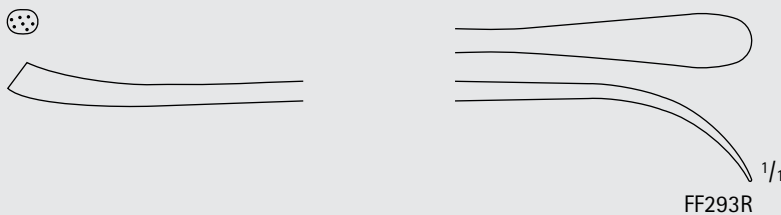

PENFIELD Dissector, Double Ended

Catalog Number	Tip	Size	Length (in.)
FF293R	CVD, S/B	#3	7 3/4



FF294R

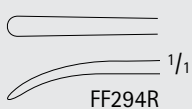

PENFIELD Dissector

Catalog Number	Tip	Size	Length (in.)
FF294R	SLIGHT-CVD	#4	8



NEURO SURGERY

PENFIELD Dissector, Double Ended

Catalog Number	Tip	Size	Length (in.)
FF295R	SLIGHT-CVD, B/B	#5	11 1/2

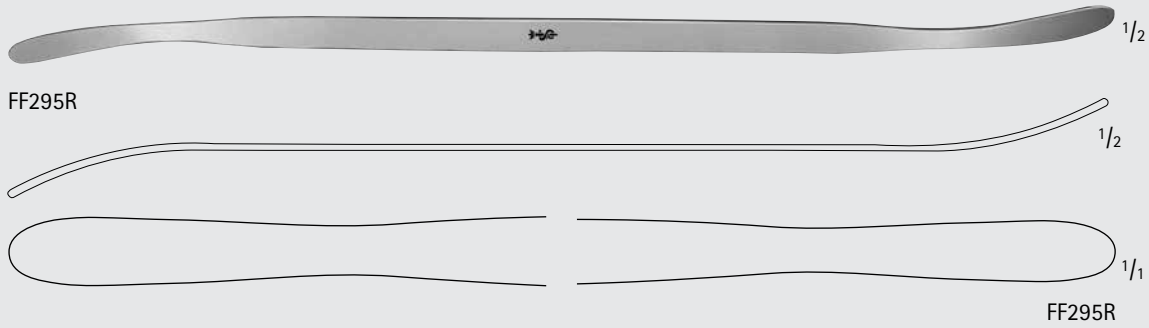

CASPAR Micro Dissector

Catalog Number	Tip	Tip Size (mm)	Length (in.)
FF310R	CVD	1.0	7 7/8
FF303R	CVD	4.5	9

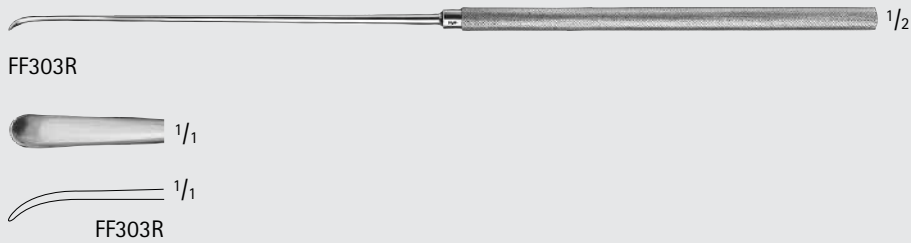

CASPAR Micro Dissector

Catalog Number	Tip	Tip Size (mm)	Shape	Length (in.)
FF307R	CVD-DOWN	2.0	BAYONET	9
FF305R	CVD-DOWN	4.5	BAYONET	9

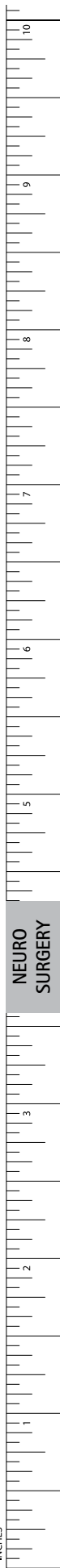
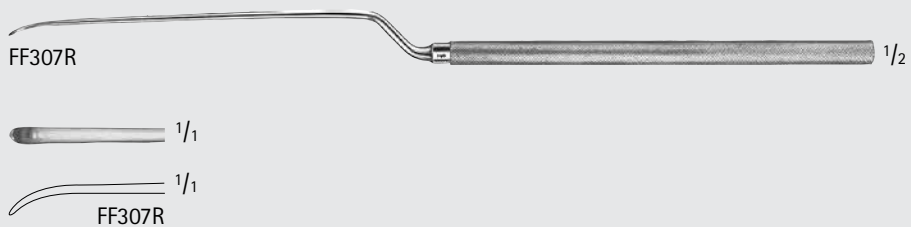
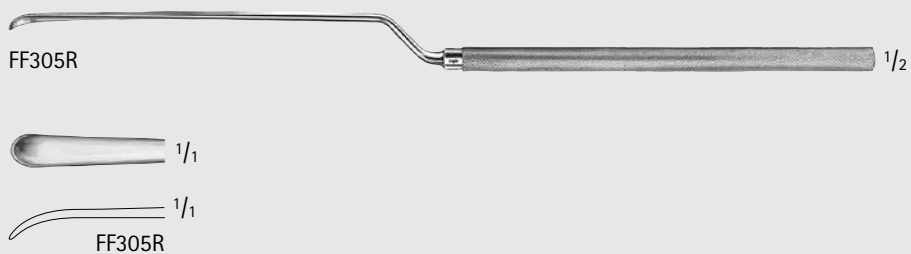

Neurosurgery

Micro Dissectors/Rasps/Hooks

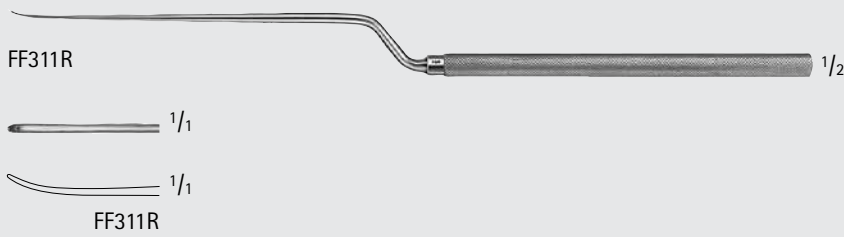

CASPAR Micro Dissector

Catalog Number	Tip	Tip Size (mm)	Shape	Length (in.)
FF311R	CVD-UP	1.0	BAYONET	8 1/4
FF312R	CVD-DOWN	1.0	BAYONET	8 1/4

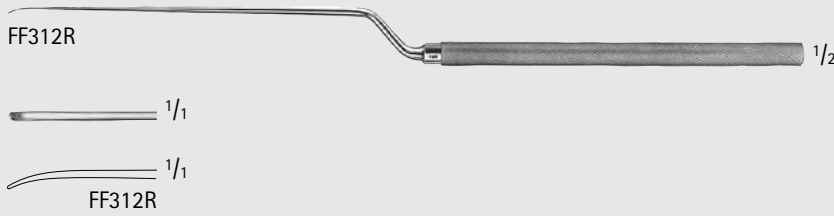

MILLIGAN Dissector, Double Ended

Catalog Number	Tip	Tip Size (mm)	Length (in.)
MF455R	S/B	7.8	8 3/4

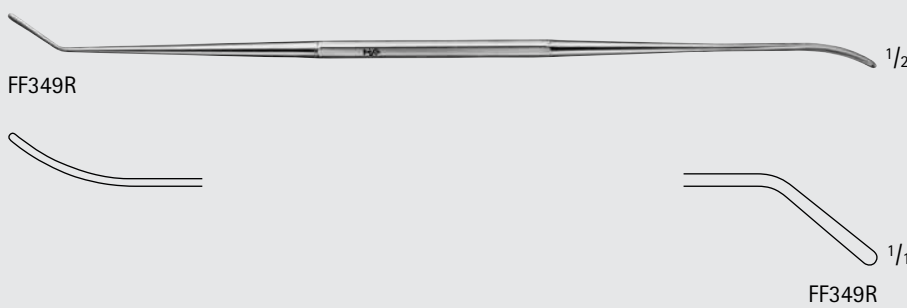

PENNYBACKER Probe Dissector, Double Ended

Catalog Number	Tip	Length (in.)
FF349R	SLIGHT-CVD	9

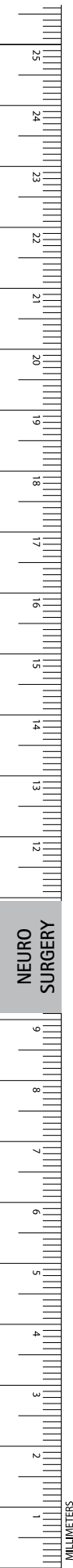

NEURO SURGERY

WOODSON Elevator, Spatula, Double Ended

Catalog Number	Tip	Length (in.)
MD605	DBL-END	10



DAVIS Vascular Spatula, Double Ended

Catalog Number	Tip	Length (in.)
FF300R	SLIGHT-CVD, B/B	9 5/8



TOENNIS Vascular Spatula, Double Ended

Catalog Number	Tip	Tip Size (mm)	Length (in.)
FF301R	SLIGHT-CVD, B/B	3 + 4	9 1/2
FF302R	SLIGHT-CVD, B/B	5 + 6	9 1/2

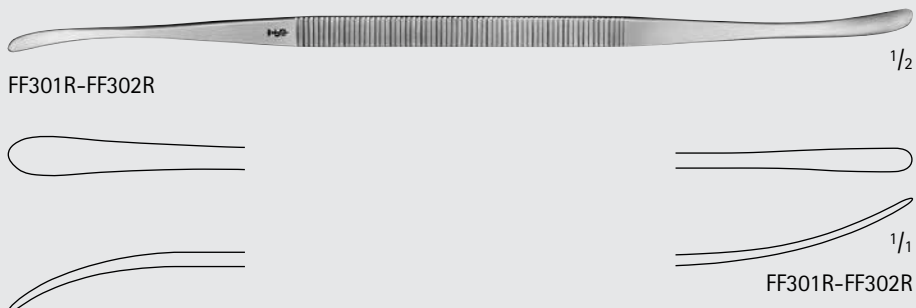

MUELLER Dura Hook

Catalog Number	Tip	Length (in.)
OL626R	1 PRONG	6

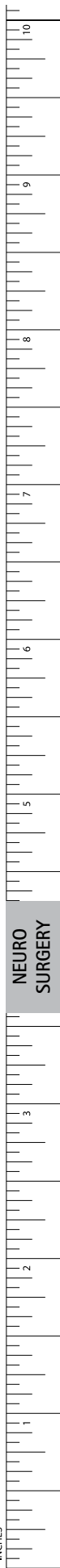

NEURO SURGERY

INCHES

Neurosurgery

Micro Dissectors/Rasps/Hooks



OL627R

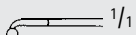

OL627R

MUELLER Dura Hook

Catalog Number	Tip	Length (in.)
OL627R	2 PRONGS	6



FF313R



FF313R

CAIRNS Dura Retractor

Catalog Number	Tip	Length (in.)
FF313R	ANG SHARP	5 1/8



FF321R



FF321R

FRAZIER Dura Retractor

Catalog Number	Tip	Length (in.)
FF321R	CVD SHARP	5 1/8



FF322R



FF322R

TOENNIS Dura Retractor

Catalog Number	Tip	Length (in.)
FF322R	CVD SHARP	6



FL711R

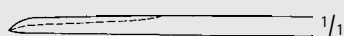

FL711R

KRAEMER Osteophyte Chisel

Catalog Number	Tip Size (mm)	Length (in.)
FL711R	2.5	8 1/2

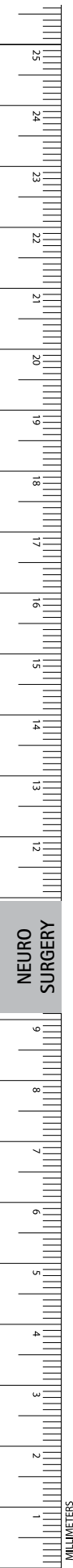

NEURO SURGERY

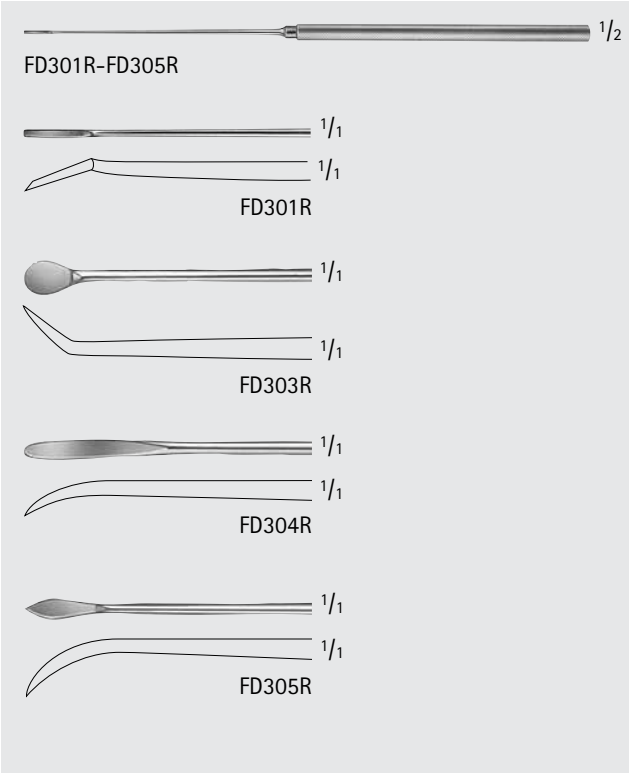
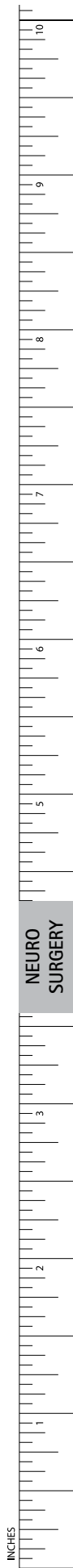

YASARGIL Micro Raspatory

Catalog Number	Tip	Shape	Length (in.)
FD301R	ANG-UP	STR	7 1/4
FD303R	ANG-UP	STR	7 1/4
FD304R	SLIGHT-CVD	STR	7 1/4
FD305R	HEAVY-CVD	STR	7 1/4

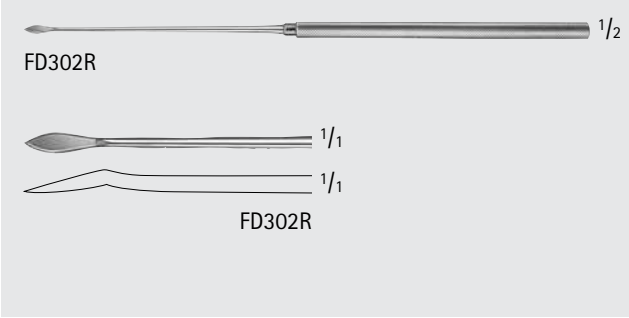

YASARGIL Micro Dissector

Catalog Number	Tip	Shape	Length (in.)
FD302R	ANG-UP	STR	7 1/4

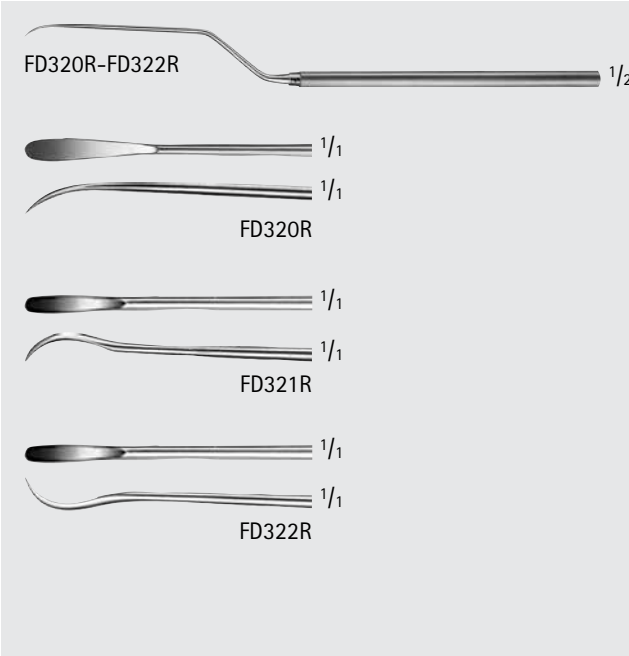

YASARGIL Micro Raspatory

Catalog Number	Tip	Shape	Length (in.)
FD320R	CVD	BAYONET	7 1/4
FD321R	CVD	BAYONET	7 1/4
FD322R	CVD-UP	BAYONET	7 1/4

Neurosurgery

Micro Dissectors/Rasps/Hooks



Twist Hook Tissue Pick

Catalog Number	Tip	Length (in.)
FD392R	1.8	7 1/4



FISCH Hook, Sharp

Catalog Number	Tip	Length (in.)
FD376R	90°	7 1/4



Dura Hook, Sharp

Catalog Number	Tip	Length (in.)
FD375R	90°	7 1/4

CASPAR Exploration Hook, Probe-End

Catalog Number	Tip	Length (in.)
BT088R	90° SHORT	9 5/8
BT089R	90° MEDIUM	9 5/8
BT090R	90° LONG	9 5/8
BT091R	45°	9 5/8

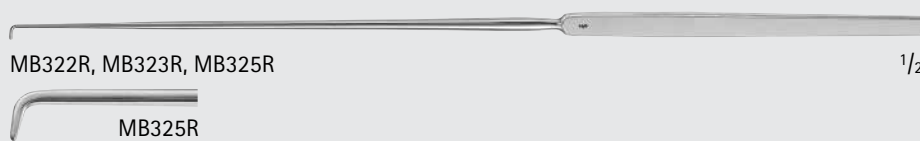
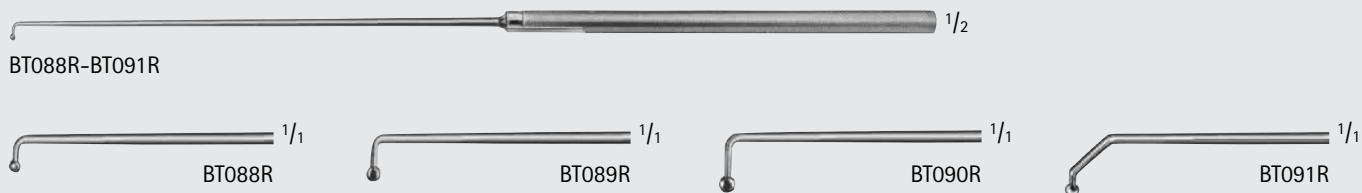

MCCULLOCH Probe

Catalog Number	Tip	Tip Size (mm)	Length (in.)
MB310R	-	COMPLETE SET	-
MB322R	ANG HOOK	2	9 1/2
MB323R	ANG HOOK	3	9 1/2
MB325R	ANG HOOK	5	9 1/2
MB328R	ANG BALL	4	9 1/2
MB335R	ANG BALL	7	9 1/2
MB320R	ANG BALL	8	9 1/2
MB326R	FORAMINAL	17	9 1/2

MB310R Includes:
1 Probe of each MB320R, MB322R, MB323R, MB325R, MB326R

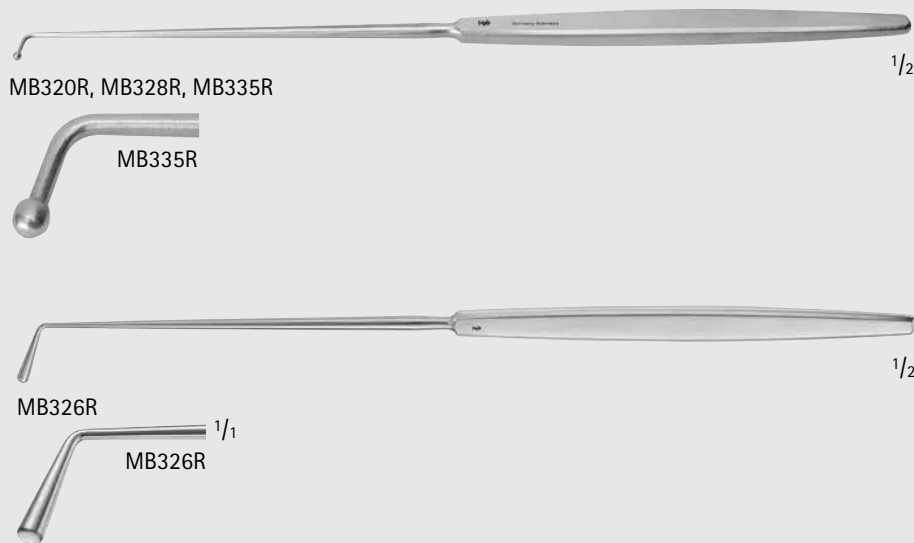

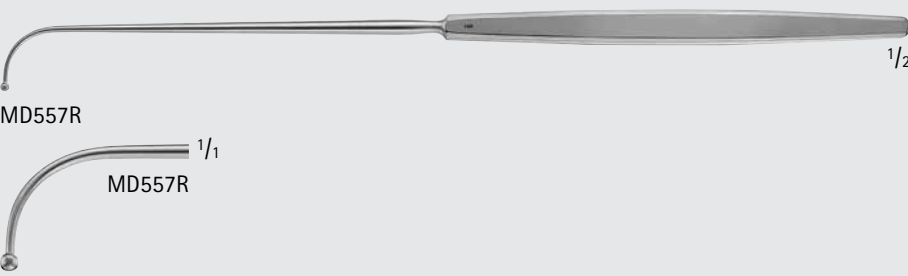
MURPHY Ball Hook

Catalog Number	Tip	Length (in.)
MD557R	HEAVY-CVD	9 1/4

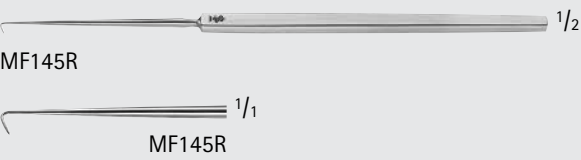

CUSHING Dura Hook

Catalog Number	Length (in.)
MF145R	5 3/4

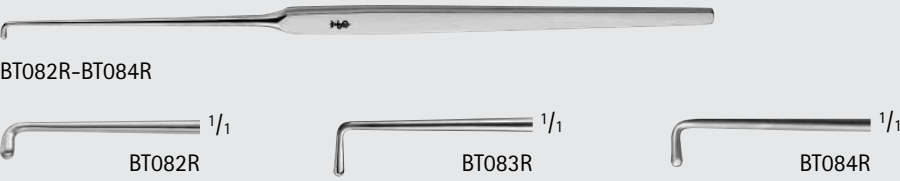

CUSHING Vessel Hook

Catalog Number	Tip Size (mm)	Tip	Length (in.)
BT082R	1 x 4	BLUNT	7 1/2
BT083R	1 x 7	BLUNT	7 1/2
BT084R	1 x 6	BLUNT	11



CRILE Vessel Hook

Catalog Number	Tip Size (mm)	Tip	Length (in.)
BT080R	1.5 x 9	BLUNT	7 7/8



MALIS Style Nerve Hook

Catalog Number	Tip	Tip Size (mm)	Length (in.)
MF143R	BLUNT	2.0	7
MF144R	BLUNT	3.0	7
MF142R	BALL-POINT	3.0	7

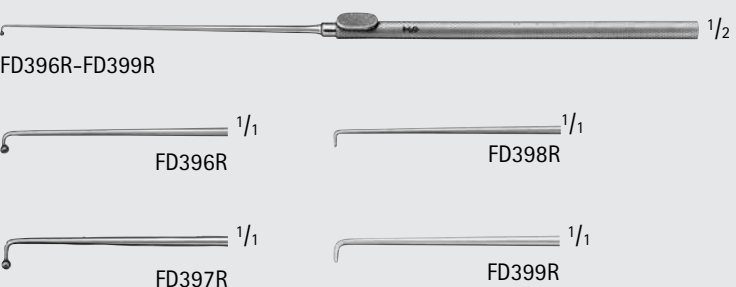

KRAYENBUEHL Nerve Hook

Catalog Number	Tip	Length (in.)
FD396R	SHORT BALL-POINT	7 1/4
FD397R	BALL-POINT	7 1/4
FD398R	BLUNT	7 1/4
FD399R	BLUNT	7 1/4

Neurosurgery

Micro Dissectors/Rasps/Hooks



DANDY Nerve Hook

Catalog Number	Tip Size (mm)	Blade End	Length (in.)
MD562	1 x 8	BLUNT	8 3/4



WEARY Nerve Hook

Catalog Number	Color	Length (in.)
MF138R	BLACK	8

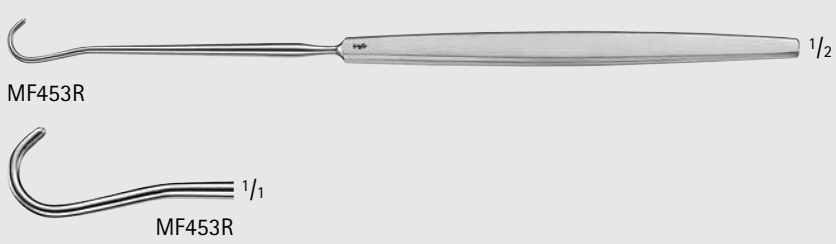

SMITHWICK Nerve Hook

Catalog Number	Length (in.)
MF453R	8 1/4

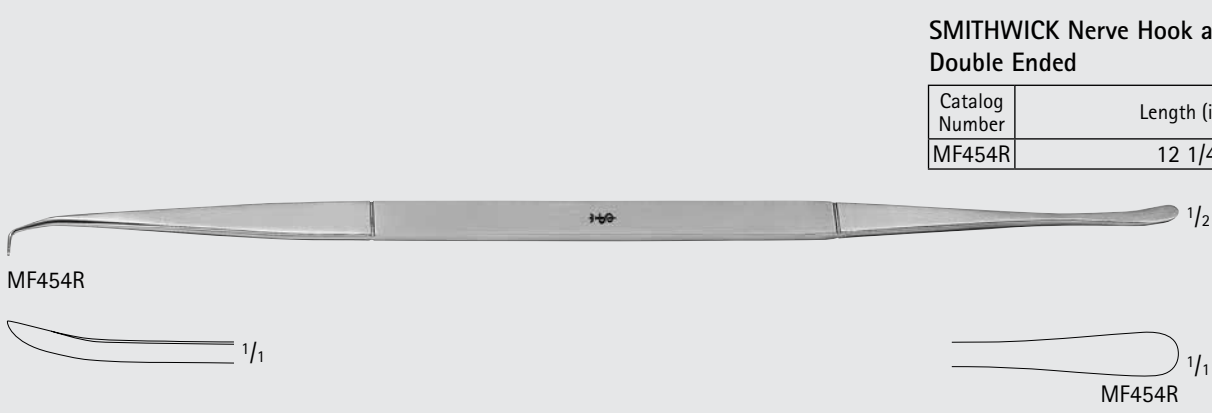

SMITHWICK Nerve Hook and Dissector, Double Ended

Catalog Number	Length (in.)
MF454R	12 1/4

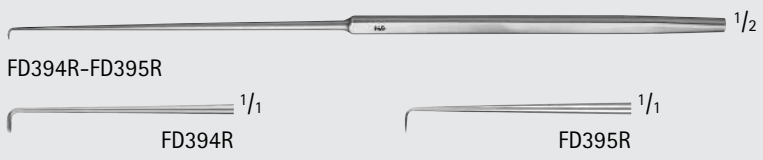

ADSON Nerve Hook

Catalog Number	Tip	Length (in.)
FD394R	BLUNT	7 1/2
FD395R	SHARP	7 1/2



NEURO SURGERY



FD270R-FD273R 1/2

FD270R 1/1 FD272R 1/1

FD271R 1/1 FD273R 1/1

YASARGIL Ligature Guide, W/ Ball Point

Catalog Number	Tip	Length (in.)
FD270R	CVD-LEFT	7 1/4
FD271R	CVD	7 1/4
FD272R	HEAVY-CVD	7 1/4
FD273R	90°	7 1/4

FD262R 1/2

FD262R 1/1

FD262R 2/1

YASARGIL Ligature Forceps

Catalog Number	Tip	Shape	Length (in.)
FD262R	TOOTHED	BAYONET	7

FF309 1/2

FF309 1/1

CASPAR Suture Pusher

Catalog Number	Shape	Length (in.)
FF309	BAYONET	9

Neurosurgery

Dural Separators and Knives

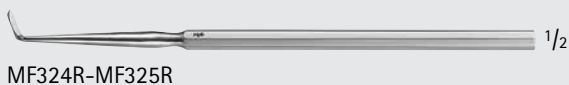

MF324R-MF325R

HOEN Dural Separator

Catalog Number	Tip	Depth (mm)	Width (mm)	Length (in.)
MF324R	90°	15	3.0	5 1/2
MF325R	45°	15	3.0	6

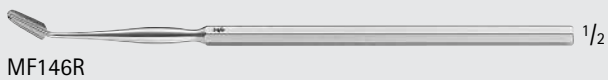

MF146R

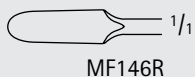

MF146R

DORSEY Dural Separator

Catalog Number	Depth (mm)	Width (mm)	Length (in.)
MF146R	15	5.0	6



MF147R



MF147R

FRAZIER Dural Separator

Catalog Number	Depth (mm)	Width (mm)	Length (in.)
MF147R	13	3.0	6



MF148R

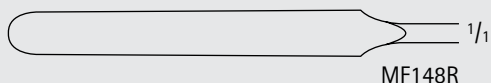

MF148R

HORSLEY Dural Separator

Catalog Number	Depth (mm)	Width (mm)	Length (in.)
MF148R	55	6.5	8 1/4



MF056R

MF056R

WOODSON Dural Separator, Double Ended

Catalog Number	Length (in.)
MF056R	7



FD410R-FD418R



FD410R

FD412R

FD414R

FD416R

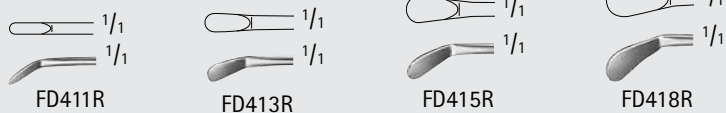

FD411R

FD413R

FD415R

FD418R

SAMII Knives for Tumor Tissue

Catalog Number	Tip Size (mm)	Length (in.)
FD410R	1.0	9
FD411R	1.5	9
FD412R	2.0	9
FD413R	2.5	9
FD414R	3.0	9
FD415R	3.5	9
FD416R	4.0	9
FD418R	5.0	9

NEURO SURGERY

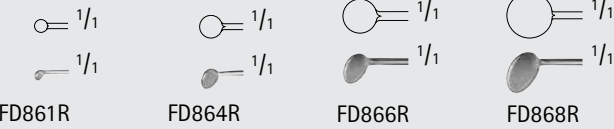

SAMII Tumor Tissue Knife, Round Blade

Catalog Number	Diameter (mm)	Length (in.)
FD861R	1.5	9
FD864R	3.0	9
FD866R	4.5	9
FD868R	6.0	9

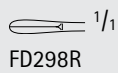

SAMII Lancet Knife

Catalog Number	Length (in.)
FD298R	9



CASPAR Micro Knife

Catalog Number	Tip	Shape	Length (in.)
FD347R	BLUNT	STR	7 7/8



KOOS Micro Vessel Knife, Bayonet-Shaped

Catalog Number	Tip	Length (in.)
FD351R	CVD-UP	7 1/4
FD352R	CVD-DOWN	7 1/4
FD353R	SLIGHT CVD-UP	7 1/4
FD354R	SLIGHT CVD-DOWN	7 1/4
FD365R	STRONG CVD-DOWN	7 1/4
FD366R	STRONG CVD-UP	7 1/4

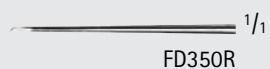

JACOBSON Vessel Knife

Catalog Number	Length (in.)
FD350R	7 1/4



Neurosurgery

Knives

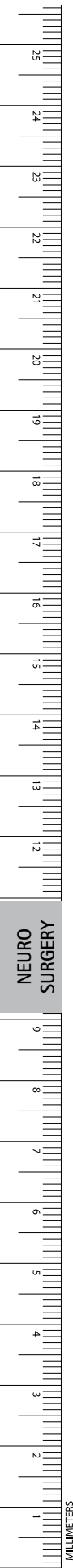

FD113D

FD113D

Diamond Knife

Catalog Number	Tip	Blade	Handle Color	Length (in.)
FD113D	7 FACETS	ROUND	GOLD	8

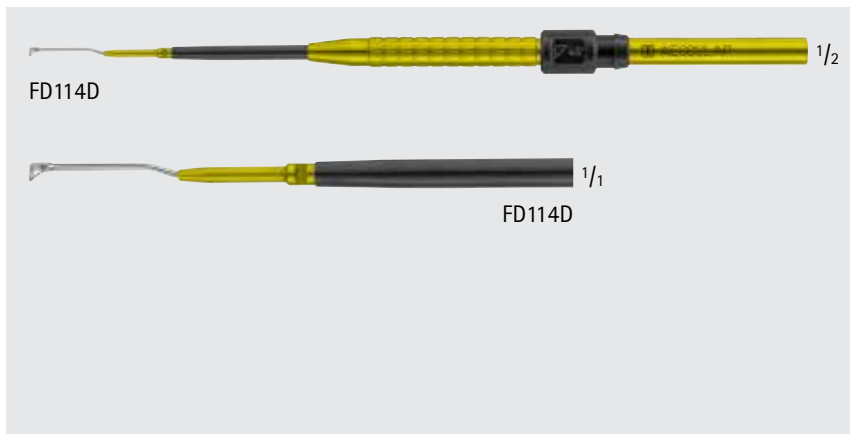

FD114D

FD114D

Diamond Knife

Catalog Number	Tip	Blade	Handle Color	Length (in.)
FD114D	60°	RETRO	COPPER	8

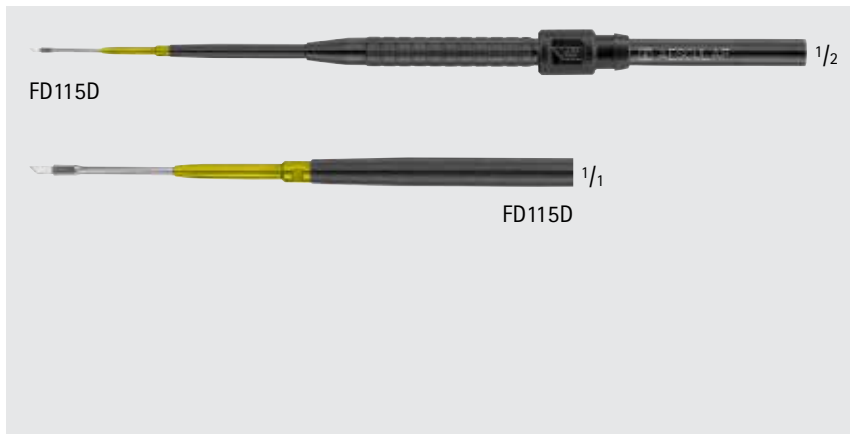

FD115D

FD115D

Diamond Knife

Catalog Number	Tip	Blade	Handle Color	Length (in.)
FD115D	45°	WEDGE	BLACK	8

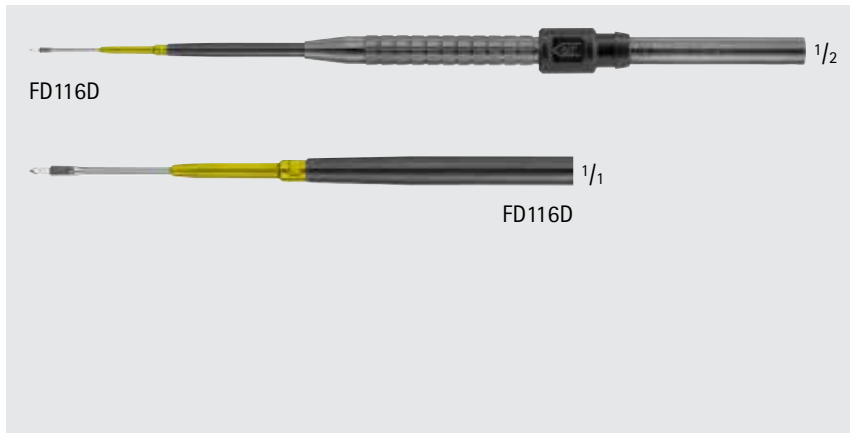

FD116D

FD116D

Diamond Knife

Catalog Number	Tip	Blade	Handle Color	Length (in.)
FD116D	60°	LANCET	BRONZE	8



OK100R-OK102R

CUSHING-LANDOLT Transsphenoidal Speculum

Catalog Number	Blade Size (mm)	Length (in.)
OK100R	70 x 15	-
OK101R	90 x 15	-
OK102R	110 x 15	-
OK103R	SPREADER FOR OK100R-OK102R	8 1/4



OK103R



MF130R-MF132R

KILLIAN Speculum, Self Retaining

Catalog Number	Blade Size (mm)
MF130R	51 x 7
MF131R	76 x 7
MF132R	90 x 7



INCHES

Neurosurgery

Pituitary Instruments



PAPAVERO-HARTMANN (CASPAR)
Transsphenoidal Speculum, Slim,
W/ Key

Catalog Number	Blade Size (mm)	Description	Length (in.)
FF589R	80 x 11	-	-
FF590R	90 x 13	-	-
FF591R	100 x 15	-	-
TE749R	-	HEX KEY	-
FF595R	34 x 9	SPREADER FOR FF589R-FF591R	5 1/2



FF595R

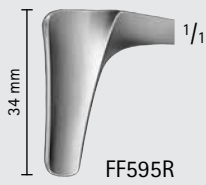

Noir Transsphenoidal Specula

Catalog Number	Blade Size (mm)
FF590B	90 x 13

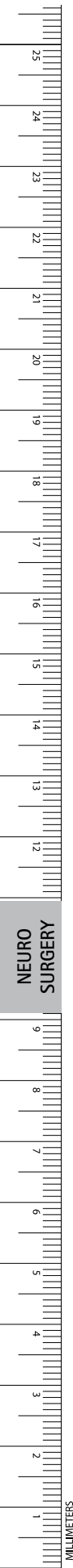

NEURO SURGERY





MF137R



MF137R

PAPAVERO Chisel

Catalog Number	Tip	Tip Size (mm)	Shape	Length (in.)
MF137R	STR	4.0	BAYONET	9



FF611R-FF614R

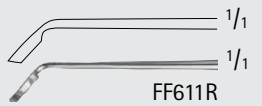

FF611R



FF614R

RAY Curette

Catalog Number	Tip	Diameter (mm)	Length (in.)
FF611R	HORIZONTAL 45°	4.0	7
FF614R	VERTICAL 45°	4.0	7

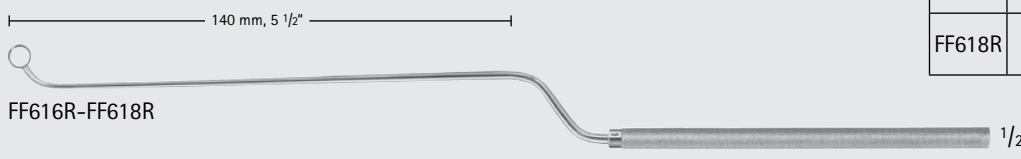

FF616R-FF618R

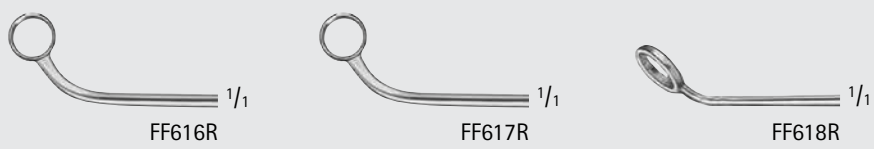

FF616R FF617R FF618R

NICOLA Curette, Malleable, Bayonet-Shaped

Catalog Number	Tip	Diameter (mm)	Working Length (in.)	Length (in.)
FF616R	CUT-RIGHT	6.5	5 1/2	10 1/4
FF617R	CUT-LEFT	6.5	5 1/2	10 1/4
FF618R	-	6.5	5 1/2	10 1/4

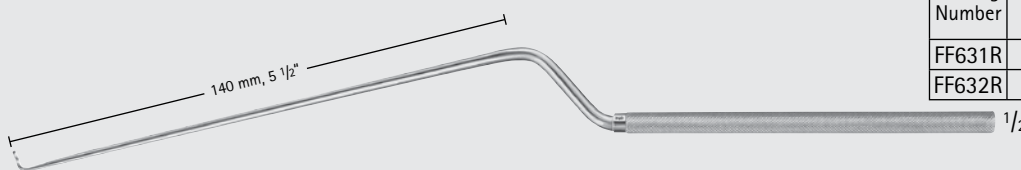

FF631R-FF632R

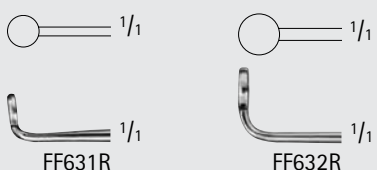

FF631R FF632R

HARDY Curette, Malleable, Bayonet-Shaped

Catalog Number	Diameter (mm)	Working Length (in.)	Length (in.)
FF631R	4.0	5 1/2	10 1/4
FF632R	6.0	5 1/2	10 1/4

Neurosurgery

Pituitary Instruments

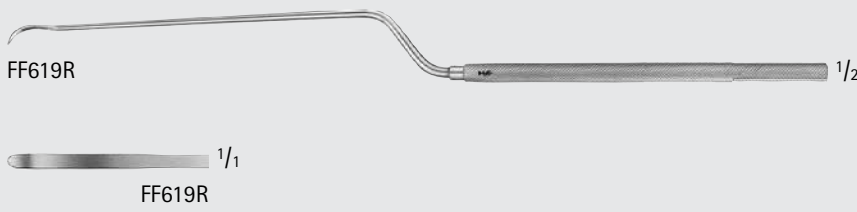

NICOLA Raspatory, Bayonet-Shaped

Catalog Number	Length (in.)
FF619R	8 3/4

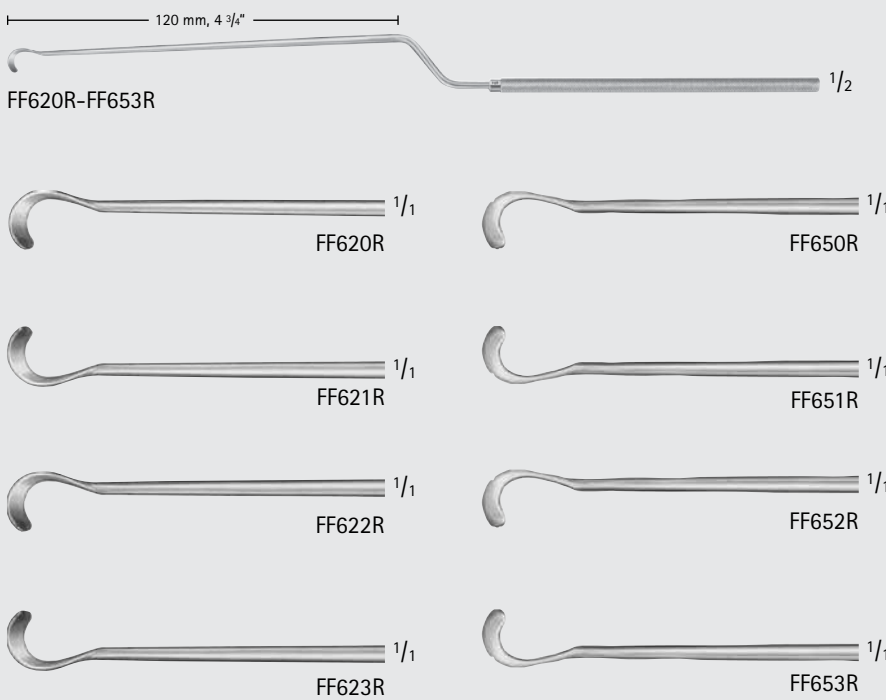

HARDY Enucleator, Bayonet-Shaped

Catalog Number	Tip	Working Length (in.)	Length (in.)
FF620R	CVD-RIGHT, CUT-RIGHT, BLUNT	4 3/4	9 5/8
FF621R	CVD-LEFT, CUT-RIGHT, BLUNT	4 3/4	9 5/8
FF622R	CVD-RIGHT, CUT-RIGHT, SHARP	4 3/4	9 5/8
FF623R	CVD-LEFT, CUT-RIGHT, SHARP	4 3/4	9 5/8
FF650R	CVD-RIGHT, CUT-LEFT, BLUNT	4 3/4	9 5/8
FF651R	CVD-LEFT, CUT-LEFT, BLUNT	4 3/4	9 5/8
FF652R	CVD-RIGHT, CUT-LEFT, SHARP	4 3/4	9 5/8
FF653R	CVD-LEFT, CUT-LEFT, SHARP	4 3/4	9 5/8

NEURO SURGERY

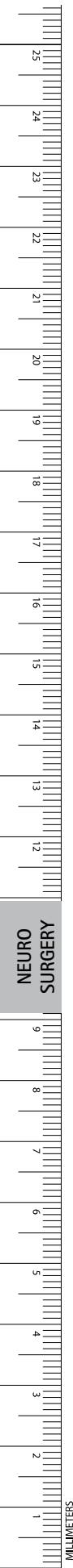

**HARDY-FAHLBUSCH Dissector,
Bayonet-Shaped**

Catalog Number	Tip	Working Length (in.)	Length (in.)
FF608R	CVD-RIGHT, CUT-LEFT, SHARP	4 3/4	9 5/8
FF609R	CVD-LEFT, CUT-RIGHT, SHARP	4 3/4	9 5/8

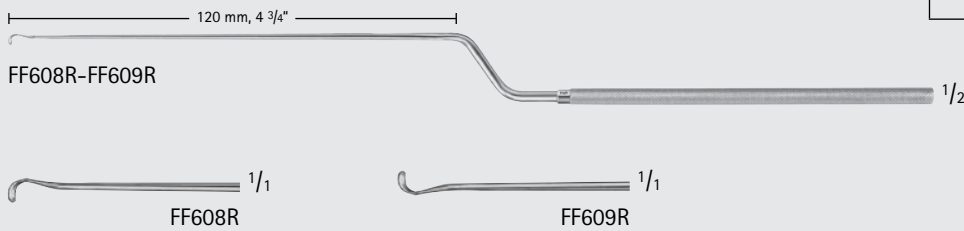

HARDY Implant Fork, Bayonet-Shaped

Catalog Number	Working Length (in.)	Length (in.)
FF624R	4 3/4	9 5/8

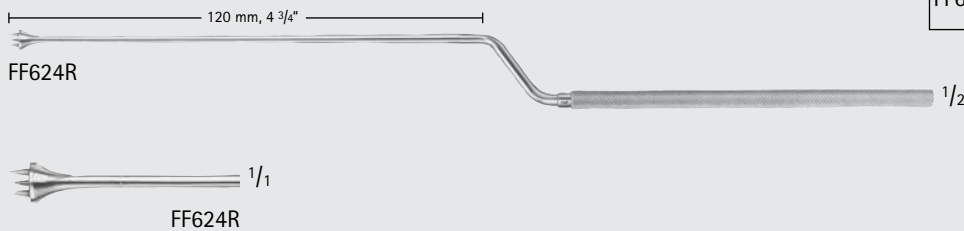

NICOLA Curette

Catalog Number	Tip	Diameter (mm)	Handle	Working Length (in.)	Length (in.)
FA030R	VERTICAL 45°	6.5	STR	5 1/2	10 1/2
FA031R	HORIZONTAL 45°	6.5	STR	5 1/2	10 1/2

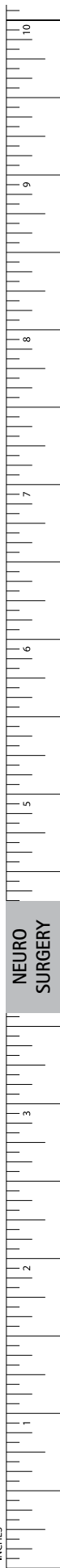
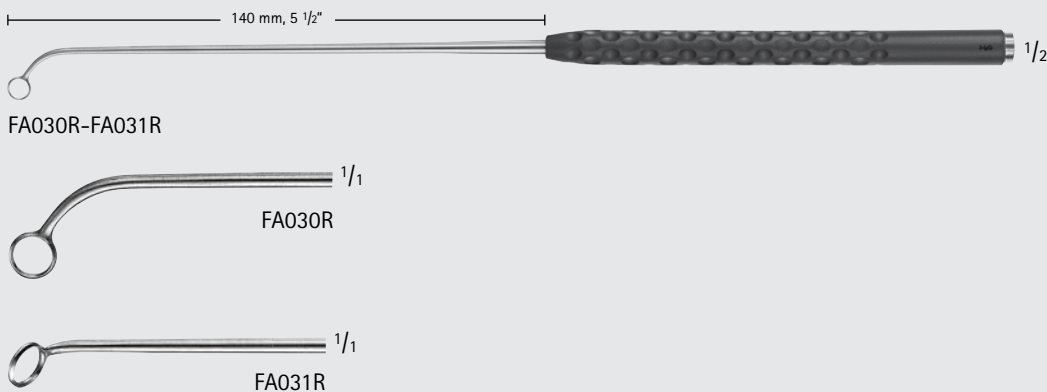

NEURO SURGERY

INCHES

Neurosurgery

Pituitary Instruments

HARDY Eucleator

Catalog Number	Tip	Handle	Working Length (in.)	Length (in.)
FA032R	CVD-LEFT, CUT-LEFT	STR	5 1/2	10 1/2
FA033R	CVD-LEFT, CUT-RIGHT	STR	5 1/2	10 1/2



FA032R-FA033R



FA032R



FA033R

HARDY Curette

Catalog Number	Tip	Diameter (mm)	Handle	Working Length (in.)	Length (in.)
FA036R	45° SHORT NECK	4.0	STR	5 1/2	10 1/2
FA034R	90° LONG NECK	4.0	STR	5 1/2	10 1/2
FA035R	90° SHORT NECK	4.0	STR	5 1/2	10 1/2
FA037R	90° LONG NECK	6.0	STR	5 1/2	10 1/2
FA038R	90° SHORT NECK	6.0	STR	5 1/2	10 1/2



FA034R-FA038R



FA034R

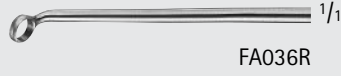

FA036R

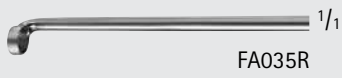

FA035R

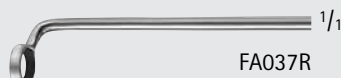

FA037R

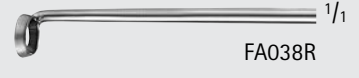

FA038R

LANDOLT-REULEN Hook

Catalog Number	Diameter (mm)	Handle	Working Length (in.)	Length (in.)
FA039R	1.7	STR	5 1/2	10 1/2



FA039R



FA039R

NEURO SURGERY

LANDOLT-REULEN Dissector

Catalog Number	Diameter (mm)	Handle	Working Length (in.)	Length (in.)
FA040R	2.0	STR	5 1/2	10 1/2



NICOLA Curette, Bayonet-Shaped

Catalog Number	Tip	Diameter (mm)	Working Length (in.)	Length (in.)
FA041R	VERTICAL 45°	6.5	5 1/8	11
FA042R	HORIZONTAL 45°	6.5	5 1/8	11

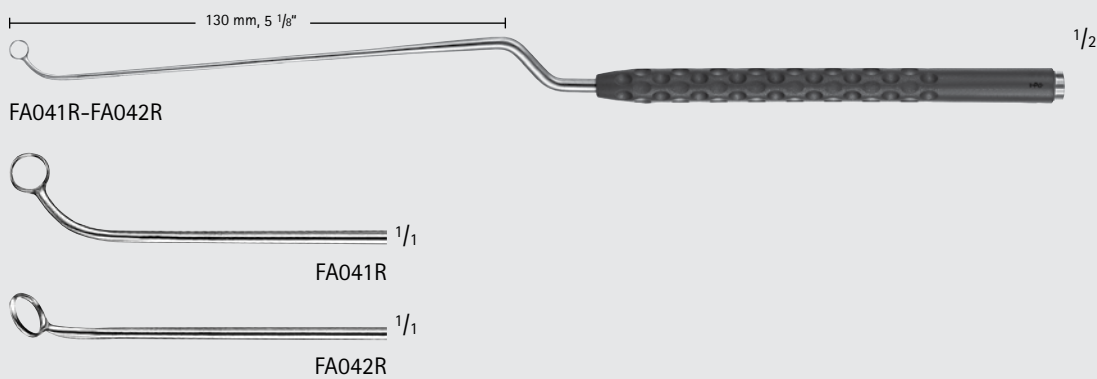

HARDY Enucleator, Bayonet-Shaped

Catalog Number	Tip	Working Length (in.)	Length (in.)
FA043R	CVD-LEFT, CUT-LEFT	5 1/8	11
FA044R	CVD-LEFT, CUT-RIGHT	5 1/8	11

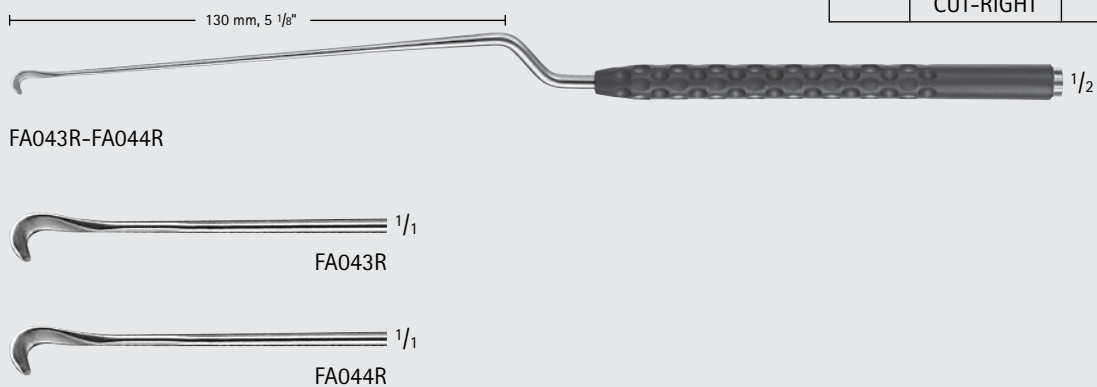

Neurosurgery

Pituitary Instruments

HARDY Curette, Bayonet-Shaped

Catalog Number	Tip	Diameter (mm)	Working Length (in.)	Length (in.)
FA045R	90° LEFT/ LONG NECK	4.0	5 1/8	11
FA046R	90° LEFT/ SHORT NECK	4.0	5 1/8	11
FA047R	90° RIGHT/ LONG NECK	4.0	5 1/8	11
FA060R	90° RIGHT/ SHORT NECK	4.0	5 1/8	11
FA061R	45° LEFT HORIZONTAL/ SHORT NECK	4.0	5 1/8	11
FA062R	45° RIGHT HORIZONTAL/ SHORT NECK	4.0	5 1/8	11
FA063R	90° LEFT/ LONG NECK	6.0	5 1/8	11
FA064R	90° LEFT/ SHORT NECK	6.0	5 1/8	11
FA065R	90° RIGHT/ LONG NECK	6.0	5 1/8	11
FA066R	90° RIGHT/ SHORT NECK	6.0	5 1/8	11

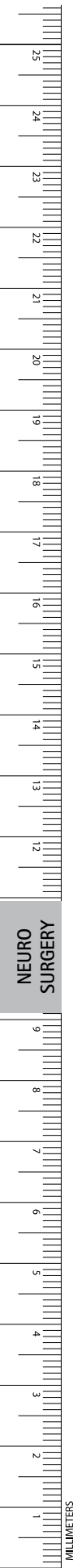
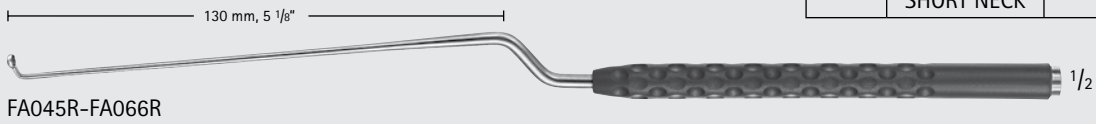

NEURO SURGERY

**LANDOLT-REULEN Hook,
Bayonet-Shaped**

Catalog Number	Diameter (mm)	Working Length (in.)	Length (in.)
FA067R	1.7	5 1/8	11

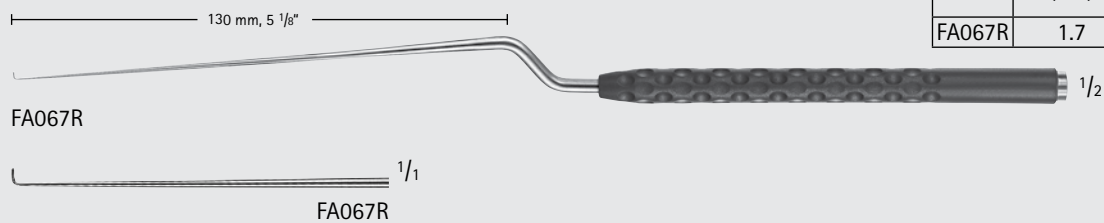

**LANDOLT-REULEN Dissector,
Bayonet-Shaped**

Catalog Number	Diameter (mm)	Working Length (in.)	Length (in.)
FA068R	2.0	5 1/8	11

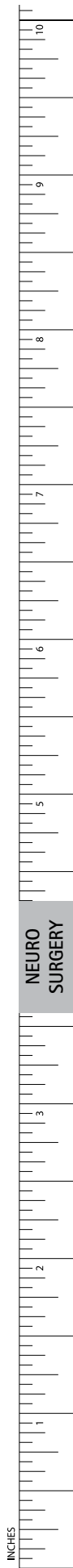
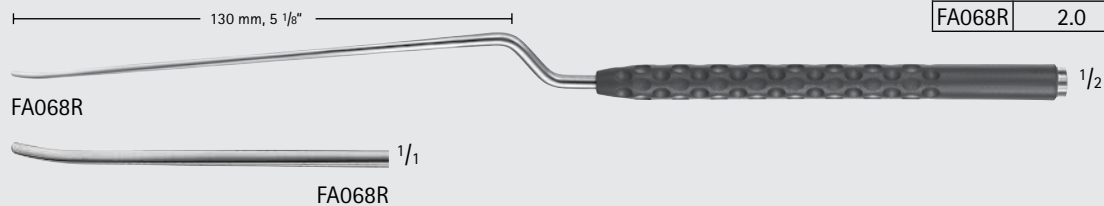

Neurosurgery

Pituitary Instruments

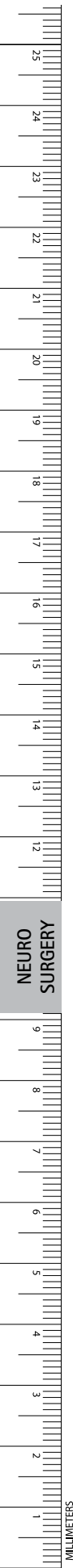

180 mm, 7"

FA069R-FA071R

1/2

1/1

1/1

FA069R

1/1

1/1

FA070R

1/1

1/1

FA071R

Micro Forceps

Catalog Number	Blade	Length (in.)
FA069R	STR	7
FA070R	CVD-RIGHT	7
FA071R	CVD-LEFT	7

180 mm, 7"

FA072R-FA075R

1/2

1/1

1/1

FA072R

1/1

1/1

FA073R

1/1

1/1

FA074R

1/1

1/1

FA075R

Micro Scissors

Catalog Number	Blade	Length (in.)
FA072R	STR	7
FA073R	CVD-LEFT	7
FA074R	CVD-RIGHT	7
FA075R	ANG	7

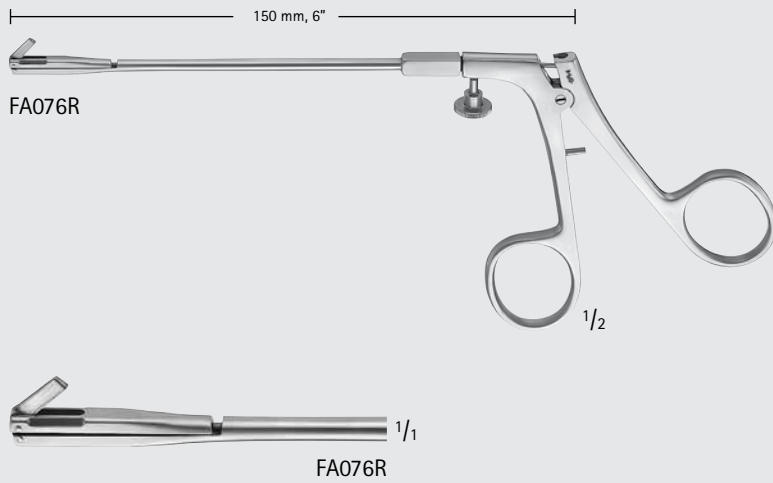

Antrum Punch, Backwards Cutting

Catalog Number	Shaft	Working Length (in.)	Length (in.)
FA076R	ROTATABLE 360°	4 3/4	6

Rotatable Ring Curette

Catalog Number	Tip	Tip Size (mm)	Length (in.)
MF112R	45°, BLUNT	2.0	10 1/2
MF113R	45°, BLUNT	3.0	10 1/2
MF114R	45°, BLUNT	4.0	10 1/2
MF115R	45°, BLUNT	5.0	10 1/2
MF116R	90°, BLUNT	2.0	10 1/2
MF117R	90°, BLUNT	3.0	10 1/2
MF118R	90°, BLUNT	4.0	10 1/2
MF119R	90°, BLUNT	5.0	10 1/2
MF120R	90°, BLUNT	6.0	10 1/2
MF121R	45°, SHARP	2.0	10 1/2
MF122R	45°, SHARP	3.0	10 1/2
MF123R	45°, SHARP	4.0	10 1/2
MF124R	45°, SHARP	5.0	10 1/2
MF125R	90°, SHARP	2.0	10 1/2
MF126R	90°, SHARP	3.0	10 1/2
MF127R	90°, SHARP	4.0	10 1/2
MF128R	90°, SHARP	5.0	10 1/2

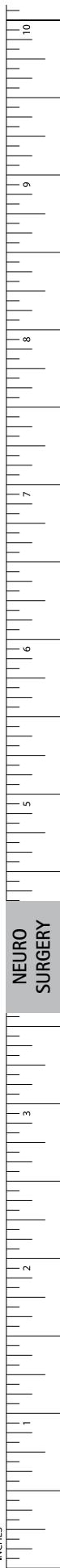

Neurosurgery

Pituitary Instruments

LANDOLT Spatula, Bayonet-Shaped

Catalog Number	Shaft	Working Length (in.)	Length (in.)
FF627R	MALLEABLE	6 1/8	10 1/4

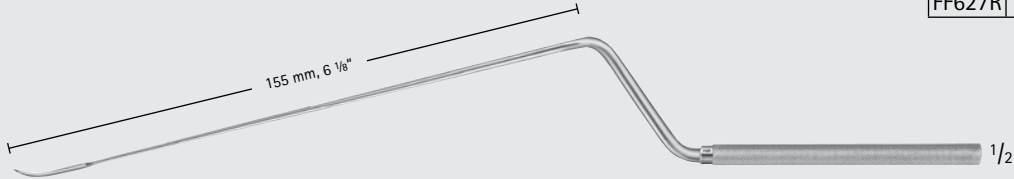

FF627R



FF627R



LANDOLT Spoon, Bayonet-Shaped

Catalog Number	Shaft	Working Length (in.)	Length (in.)
FF628R	MALLEABLE	6 1/8	10 1/4

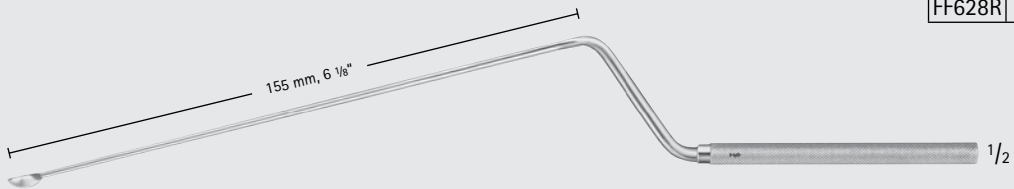

FF628R



FF628R



NEURO SURGERY

LANDOLT Hook, Blunt, Bayonet-Shaped

Catalog Number	Shaft	Working Length (in.)	Length (in.)
FF629R	MALLEABLE	6 1/8	10 1/4

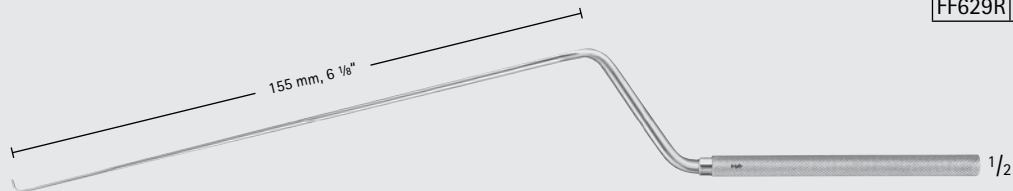

FF629R



FF629R

LANDOLT Enucleator, Malleable, Bayonet-Shaped

Catalog Number	Tip	Working Length (in.)	Length (in.)
FF625R	RIGHT BLUNT DOWN	6 1/8	10 1/4
FF626R	RIGHT BLUNT UP	6 1/8	10 1/4

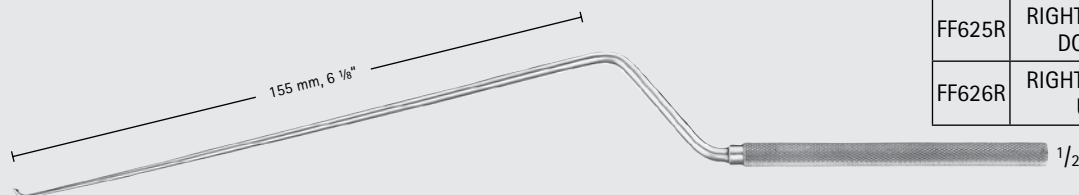

FF625R-FF626R

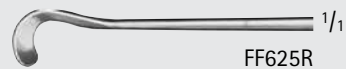

FF625R



FF626R

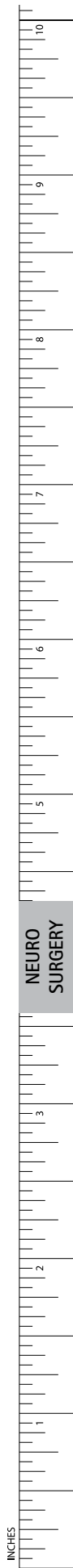

NEURO SURGERY

INCHES

Neurosurgery

Pituitary Instruments

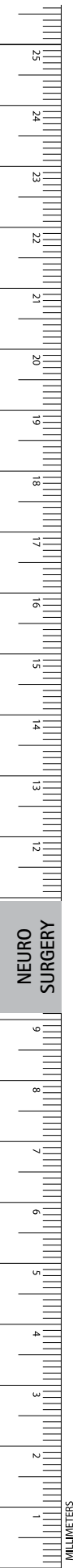

LANDOLT-REULEN Raspatory, Bayonet-Shaped

Catalog Number	Diameter (mm)	Shaft	Working Length (in.)	Length (in.)
FF640R	2.2	RIGID	6 1/8	10 1/4
FF641R	3.2	RIGID	6 1/8	10 1/4

155 mm, 6 1/8"

FF640R-FF641R

1/1
FF640R

1/1
FF641R

LANDOLT-REULEN Curette, Bayonet-Shaped

Catalog Number	Diameter (mm)	Shaft	Working Length (in.)	Length (in.)
FF642R	2.5	RIGID	6 1/8	10 1/4

155 mm, 6 1/8"

FF642R

1/1

1/1
FF642R

LANDOLT-REULEN Hook, Blunt, Bayonet-Shaped

Catalog Number	Tip Size (mm)	Shaft	Working Length (in.)	Length (in.)
FF643R	1.7	RIGID	6 1/8	10 1/4

155 mm, 6 1/8"

FF643R

1/1
FF643R

LANDOLT-REULEN Dissector, Bayonet-Shaped

Catalog Number	Diameter (mm)	Shaft	Working Length (in.)	Length (in.)
FF644R	2.0	RIGID	6 1/8	10 1/4

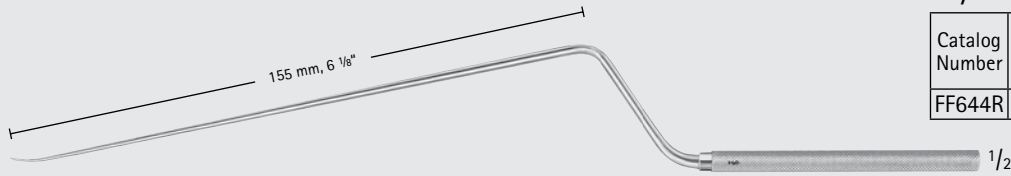

FF644R

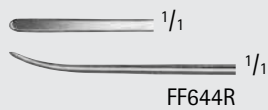

FF644R

FAHLBUSCH Spoon, Bayonet-Shaped

Catalog Number	Diameter (mm)	Shaft	Working Length (in.)	Length (in.)
FF635R	2.0	MALLEABLE	6 1/8	10 1/4

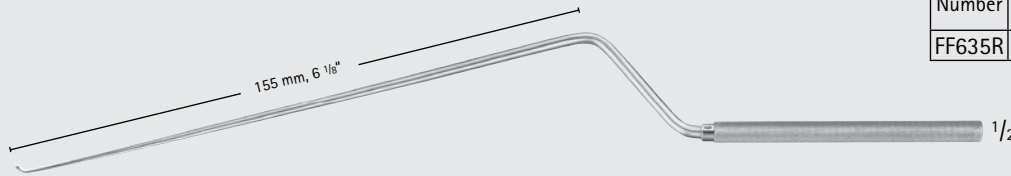

FF635R

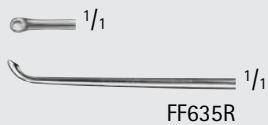

FF635R

FAHLBUSCH Curette, Bayonet-Shaped

Catalog Number	Diameter (mm)	Shaft	Working Length (in.)	Length (in.)
FF637R	2.5	MALLEABLE	6 1/8	10 1/4

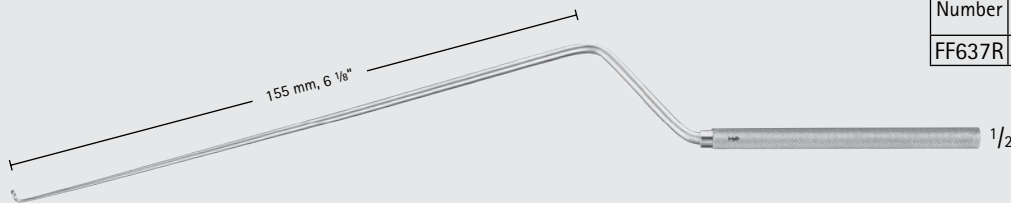

FF637R

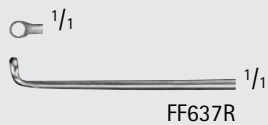

FF637R

D'ERRICO Hypophyseal Forceps

Catalog Number	Jaw	Jaw Size (mm)	Length (in.)
MF410R	CUP	6.0	8 1/2



MF410R



MF410R

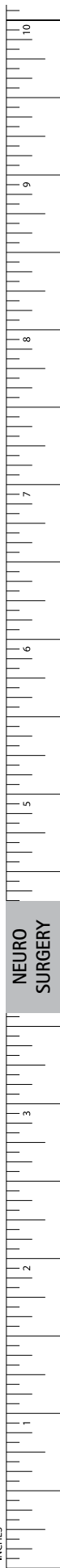

NEURO SURGERY

INCHES

Neurology

Pituitary Instruments

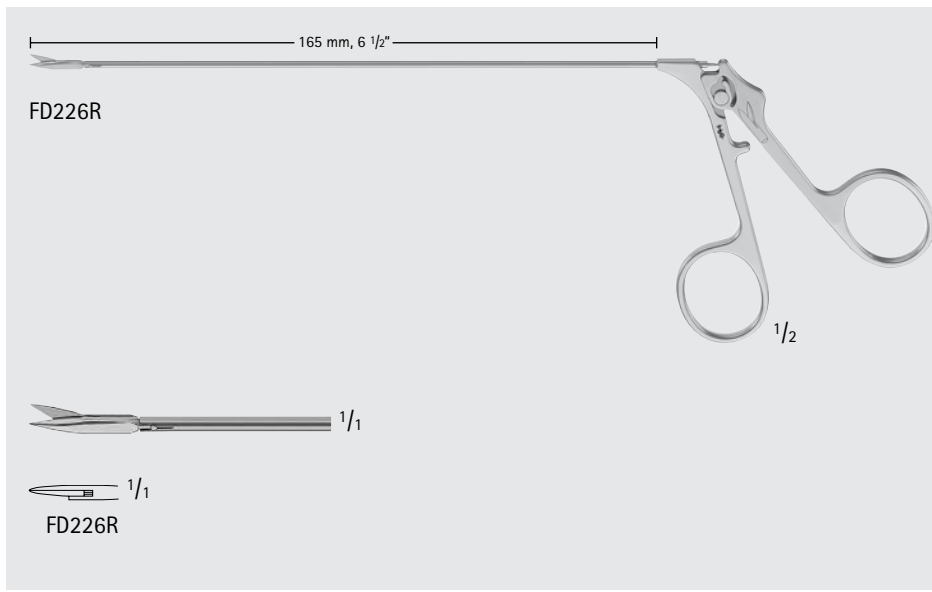
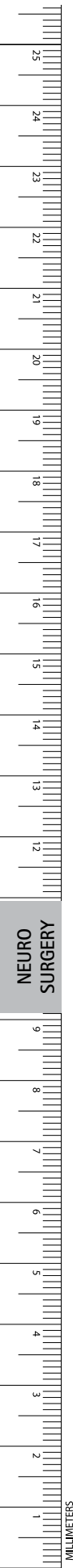

NICOLA Modular Micro Scissors

Catalog Number	Tip	Blade	Shaft	Working Length (in.)
FD226R	S/S	STR	TUBULAR	6 1/2

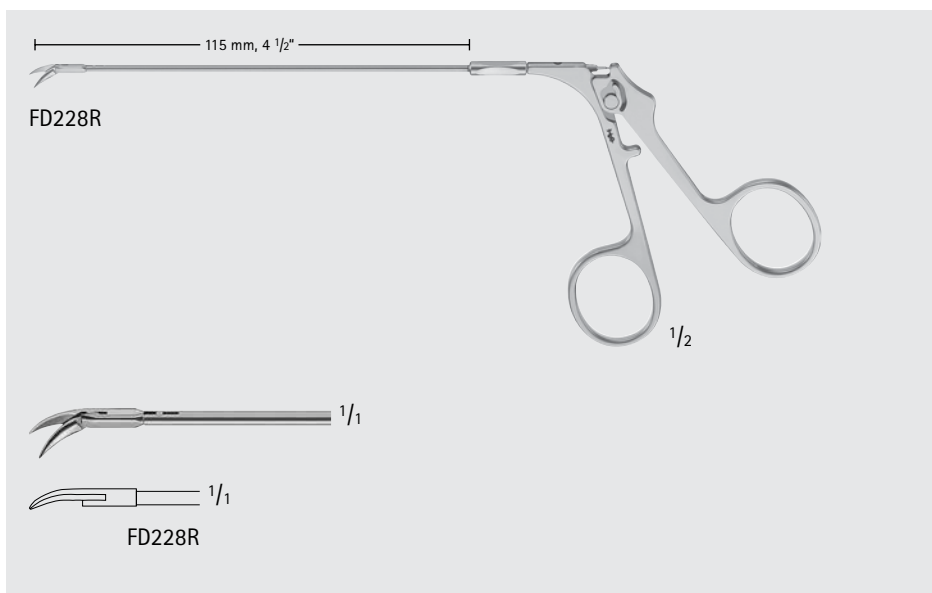

CASPAR Modular Micro Scissors

Catalog Number	Tip	Blade	Shaft	Working Length (in.)
FD228R	S/S	CVD	ROTATABLE 360°	4 1/2

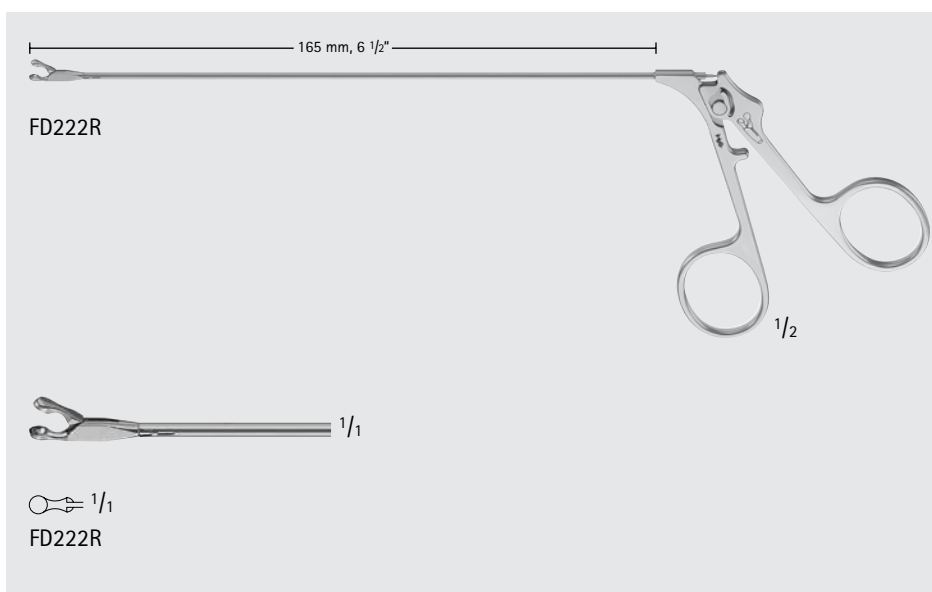

NICOLA Modular Micro Forceps

Catalog Number	Jaw	Tip Size (mm)	Working Length (in.)
FD222R	SCOOP-SHAPED	DIAM. 2.5 MM	6 1/2

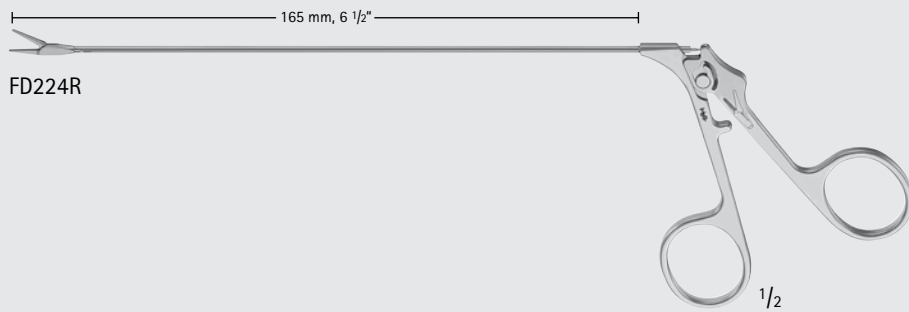

FD224R

YASARGIL-NICOLA Modular Micro Forceps

Catalog Number	Jaw	Tip	Working Length (in.)
FD224R	LONG	STR, SERR	6 1/2



FD224R

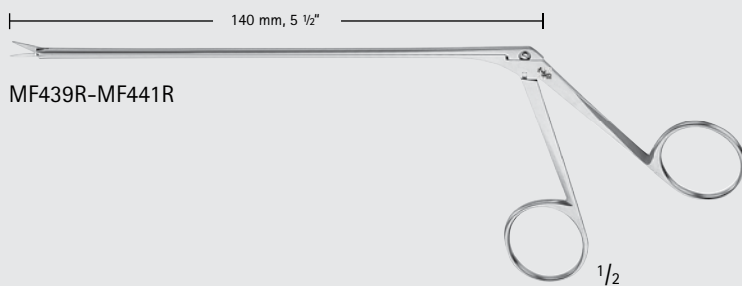

MF439R-MF441R

KURZE Dissecting Scissors

Catalog Number	Tip	Blade	Length (in.)
MF439R	B/B	STR	5 1/2
MF440R	B/B	CVD-LEFT	5 1/2
MF441R	B/B	CVD-RIGHT	5 1/2

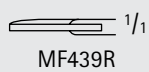

MF439R

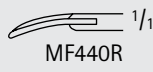

MF440R



MF441R

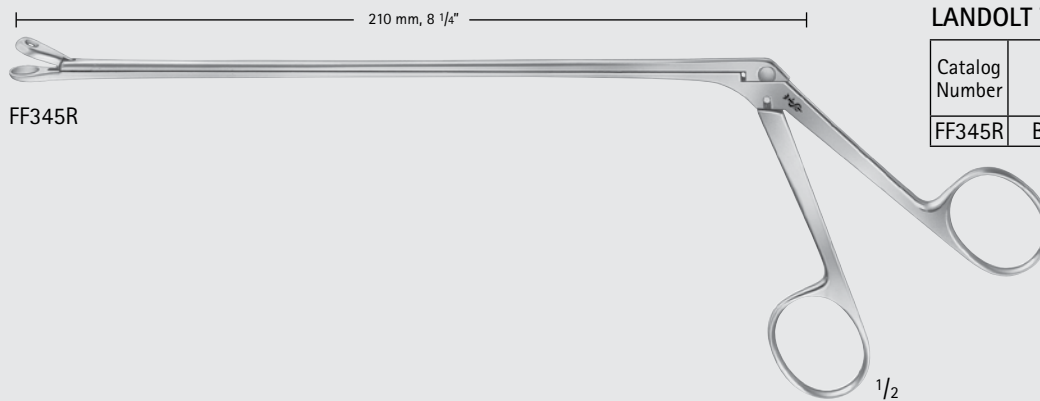

FF345R

LANDOLT Tumor Grasping Forceps

Catalog Number	Jaw	Jaw Size (mm)	Shaft Length (in.)
FF345R	BLUNT	DIAM. 9.0	8 1/4

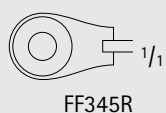

FF345R

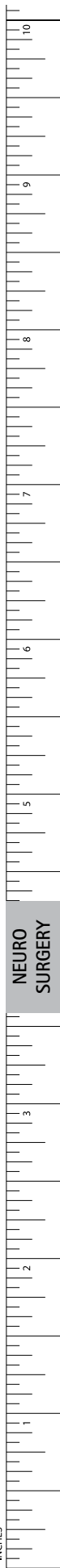

NEURO SURGERY

INCHES

Neurosurgery

Suction Cannulas

- Teardrop shaped thumb control for a very precise suction regulation
- Malleable material for individual forming of the suction hose
- Conical design of the tube prevents plugging
- Delivered with stylet

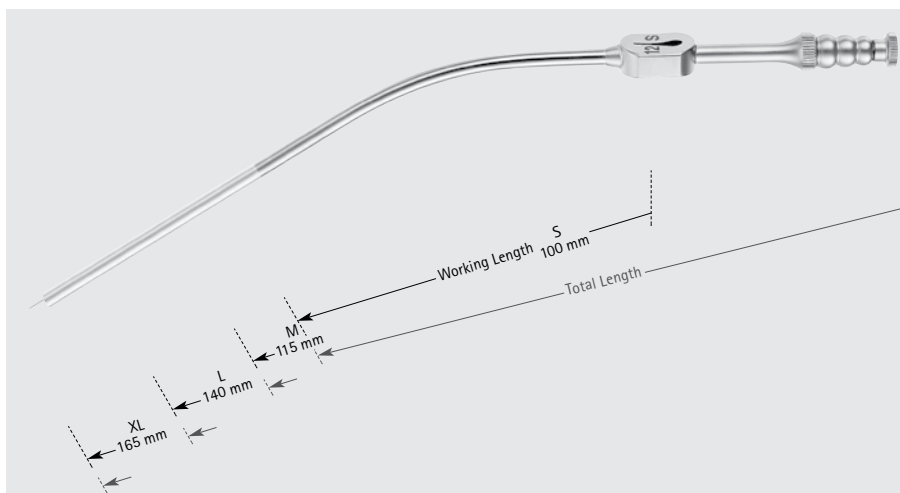

GF391R-GF429R

Suction Tube, Fukushima Style, W/ Tapered Teardrop Control

Catalog Number	Size	Tip Size (mm)	Tip Size (FR)	Working Length (in.)	Length (in.)
GF401R	S	1.0	3	4	6 1/2
GF402R	S	1.4	4	4	6 1/2
GF403R	S	1.7	5	4	6 1/2
GF404R	S	2.0	6	4	6 1/2
GF405R	S	2.3	7	4	6 1/2
GF406R	S	2.7	8	4	6 1/2
GF407R	S	3.0	9	4	6 1/2
GF408R	S	3.3	10	4	6 1/2
GF409R	S	4.0	12	4	6 1/2
GF391R	M	1.0	3	4 1/2	7
GF392R	M	1.4	4	4 1/2	7
GF393R	M	1.7	5	4 1/2	7
GF394R	M	2.0	6	4 1/2	7
GF395R	M	2.3	7	4 1/2	7
GF396R	M	2.7	8	4 1/2	7
GF397R	M	3.0	9	4 1/2	7
GF398R	M	3.3	10	4 1/2	7
GF399R	M	4.0	12	4 1/2	7
GF411R	L	1.0	3	5 1/2	8
GF412R	L	1.4	4	5 1/2	8
GF413R	L	1.7	5	5 1/2	8
GF414R	L	2.0	6	5 1/2	8
GF415R	L	2.3	7	5 1/2	8
GF416R	L	2.7	8	5 1/2	8
GF417R	L	3.0	9	5 1/2	8
GF418R	L	3.3	10	5 1/2	8
GF419R	L	4.0	12	5 1/2	8
GF421R	XL	1.0	3	6 1/2	9
GF422R	XL	1.4	4	6 1/2	9
GF423R	XL	1.7	5	6 1/2	9
GF424R	XL	2.0	6	6 1/2	9
GF425R	XL	2.3	7	6 1/2	9
GF426R	XL	2.7	8	6 1/2	9
GF427R	XL	3.0	9	6 1/2	9
GF428R	XL	3.3	12	6 1/2	9
GF429R	XL	4.0	12	6 1/2	9

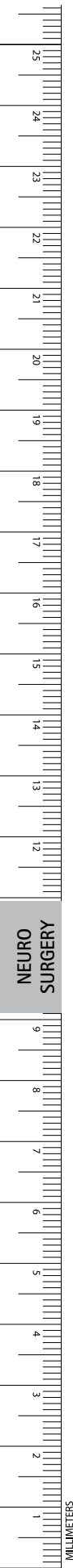



GF025B-GF059B



MIN Instruments, Noir™ Modular Suction Cannula,
F/ Golfball Handle

Catalog Number	Size	Tip	Tip Size (mm)	Tip Size (FR)	Working Length (in.)
GF025B	S	STR	1.4	4	3 1/8
GF026B	S	STR	2.0	6	3 1/8
GF027B	S	STR	2.7	8	3 1/8
GF030B	M	CVD LEFT	2.0	6	4
GF031B	M	CVD RIGHT	2.0	6	4
GF032B	M	CVD LEFT	2.7	8	4
GF033B	M	CVD RIGHT	2.7	8	4
GF035B	M	STR	1.4	4	4
GF036B	M	STR	2.0	6	4
GF037B	M	STR	2.7	8	4
GF038B	M	STR, LATERAL HOLES	2.0	6	4
GF039B	M	STR, LATERAL HOLES	2.7	8	4
GF045B	L	STR	1.4	4	4 3/4
GF046B	L	STR	2.0	6	4 3/4
GF047B	L	STR	2.7	8	4 3/4
GF048B	L	STR, LATERAL HOLES	2.0	6	4 3/4
GF049B	L	STR, LATERAL HOLES	2.7	8	4 3/4
GF055B	XL	STR	1.4	4	5 1/2
GF056B	XL	STR	2.0	6	5 1/2
GF057B	XL	STR	2.7	8	5 1/2
GF058B	XL	STR, LATERAL HOLES	2.0	6	5 1/2
GF059B	XL	STR, LATERAL HOLES	2.7	8	5 1/2



GF005B

Modular Thumb Control for MIN
Suction Cannulas

Catalog Number	Description
GF005B	TEAR DROP SHAPED



Neurosurgery

Suction Cannulas

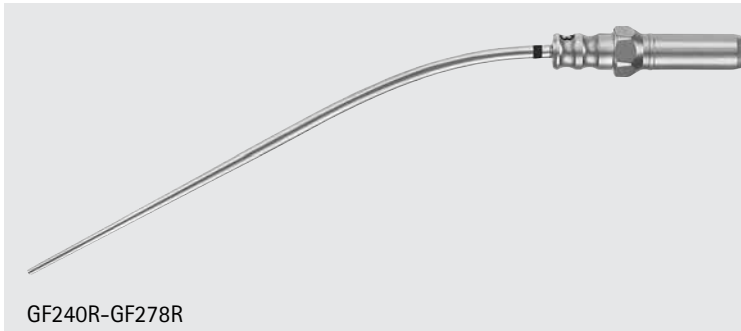
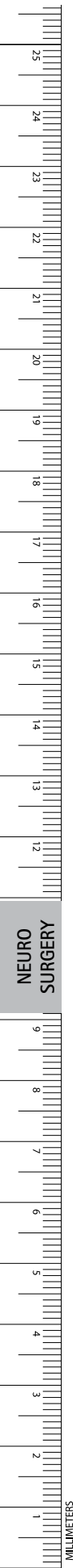

GF240R-GF278R

Modular Suction Cannula

Catalog Number	Size)	Tip Size (mm)	Tip Size (FR)	Working Length (in.)	Length (in.)
GF240R	S	1.0	3	4	7 1/4
GF241R	S	1.4	4	4	7 1/4
GF242R	S	1.7	5	4	7 1/4
GF243R	S	2.0	6	4	7 1/4
GF244R	S	2.3	7	4	7 1/4
GF245R	S	2.7	8	4	7 1/4
GF246R	S	2.0	9	4	7 1/4
GF247R	S	3.3	10	4	7 1/4
GF248R	S	4.0	12	4	7 1/4
GF250R	M	1.0	3	4 1/2	7 7/8
GF251R	M	1.4	4	4 1/2	7 7/8
GF252R	M	1.7	5	4 1/2	7 7/8
GF253R	M	2.0	6	4 1/2	7 7/8
GF254R	M	2.3	7	4 1/2	7 7/8
GF255R	M	2.7	8	4 1/2	7 7/8
GF256R	M	3.0	9	4 1/2	7 7/8
GF257R	M	3.3	10	4 1/2	7 7/8
GF258R	M	4.0	12	4 1/2	7 7/8
GF260R	L	1.0	3	5 1/2	8 7/8
GF261R	L	1.4	4	5 1/2	8 7/8
GF262R	L	1.7	5	5 1/2	8 7/8
GF263R	L	2.0	6	5 1/2	8 7/8
GF264R	L	2.3	7	5 1/2	8 7/8
GF265R	L	2.7	8	5 1/2	8 7/8
GF266R	L	3.0	9	5 1/2	8 7/8
GF267R	L	3.3	10	5 1/2	8 7/8
GF268R	L	4.0	12	5 1/2	8 7/8
GF270R	XL	1.0	3	6 1/2	9 3/4
GF271R	XL	1.4	4	6 1/2	9 3/4
GF272R	XL	1.7	5	6 1/2	9 3/4
GF273R	XL	2.0	6	6 1/2	9 3/4
GF274R	XL	2.3	7	6 1/2	9 3/4
GF275R	XL	2.7	8	6 1/2	9 3/4
GF276R	XL	3.0	9	6 1/2	9 3/4
GF277R	XL	3.3	10	6 1/2	9 3/4
GF278R	XL	4.0	12	6 1/2	9 3/4



GF235R

Thumb Control for Modular Suction Tubes

Catalog Number	Shape
GF235R	TEARDROP SHAPED

RAABE Micro Suction Tube, W/ Tapered Teardrop Control

Catalog Number	Tip	Tip Size (mm)	Tip Size (FR)	Handle	Working Length (in.)	Length (in.)
GF470R	ATRAUMATIC	1.4	4	YELLOW	3 1/8	5 1/8
GF471R	ATRAUMATIC	2.0	6	BLUE	3 1/8	5 1/8
GF472R	ATRAUMATIC	2.7	8	GREEN	3 1/8	5 1/8
GF473R	ATRAUMATIC	1.4	4	YELLOW	4	6
GF474R	ATRAUMATIC	2.0	6	BLUE	4	6
GF475R	ATRAUMATIC	2.7	8	GREEN	4	6
GF476R	ATRAUMATIC	1.4	4	YELLOW	4 3/4	6 1/2
GF477R	ATRAUMATIC	2.0	6	BLUE	4 3/4	6 1/2
GF478R	ATRAUMATIC	2.7	8	GREEN	4 3/4	6 1/2
GF479R	ATRAUMATIC	1.4	4	YELLOW	5 1/2	7 1/4
GF480R	ATRAUMATIC	2.0	6	BLUE	5 1/2	7 1/4
GF481R	ATRAUMATIC	2.7	8	GREEN	5 1/2	7 1/4



GF470R-GF481R

Suction Tube, Fukushima Style, W/ Tapered Teardrop Control

Catalog Number	Tip	Tip Size (mm)	Tip Size (FR)	Working Length (in.)	Length (in.)
GF431R	CVD-RIGHT	2.0	8	5 1/4	9 3/4
GF432R	CVD-LEFT	2.0	5 1/4	9 3/4	

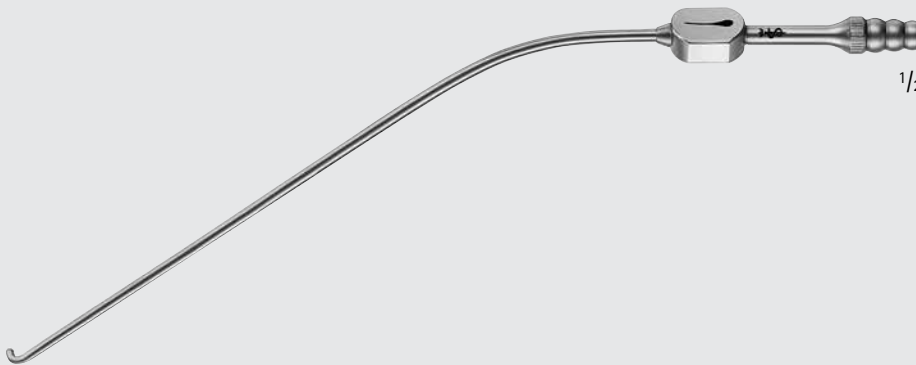

GF431R-GF432R



GF431R-GF432R



NEURO SURGERY

INCHES

Neurosurgery

Suction Cannulas

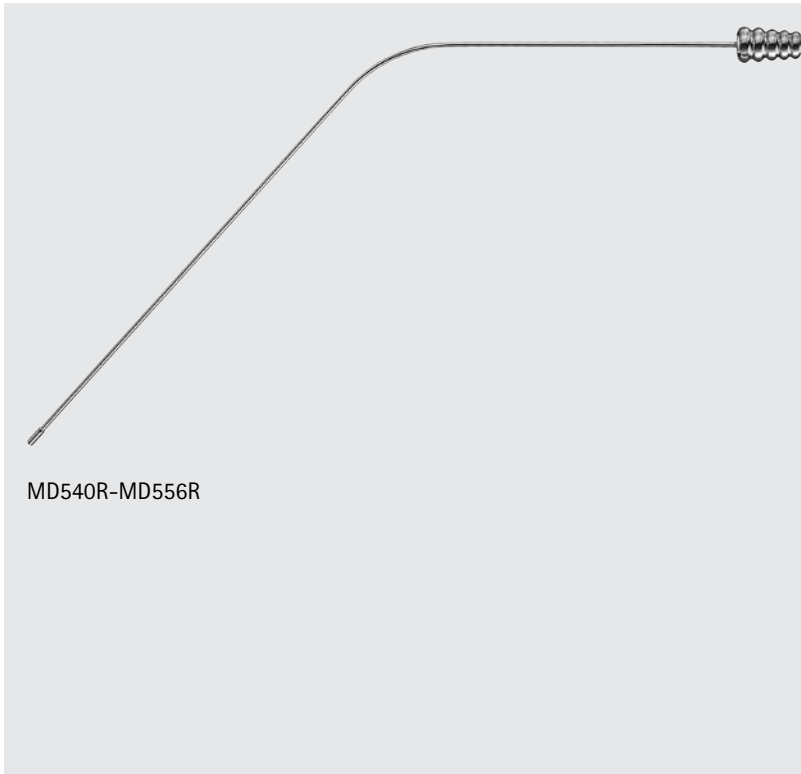
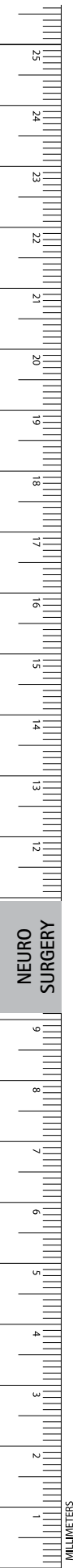

MD540R-MD566R

YASARGIL Suction Tube

Catalog Number	Tip Size (mm)	Length (in.)
MD540R	1.5	5
MD541R	1.5	6
MD542R	1.5	7
MD543R	1.5	8 1/2
MD544R	2.0	5
MD545R	2.0	6
MD546R	2.0	7
MD547R	2.0	8 1/2
MD548R	2.5	5
MD549R	2.5	6
MD550R	2.5	7
MD551R	2.5	8 1/2
MD552R	3.5	5
MD553R	3.5	6
MD554R	3.5	7
MD555R	3.5	8 1/2
MD556R	4.5	7

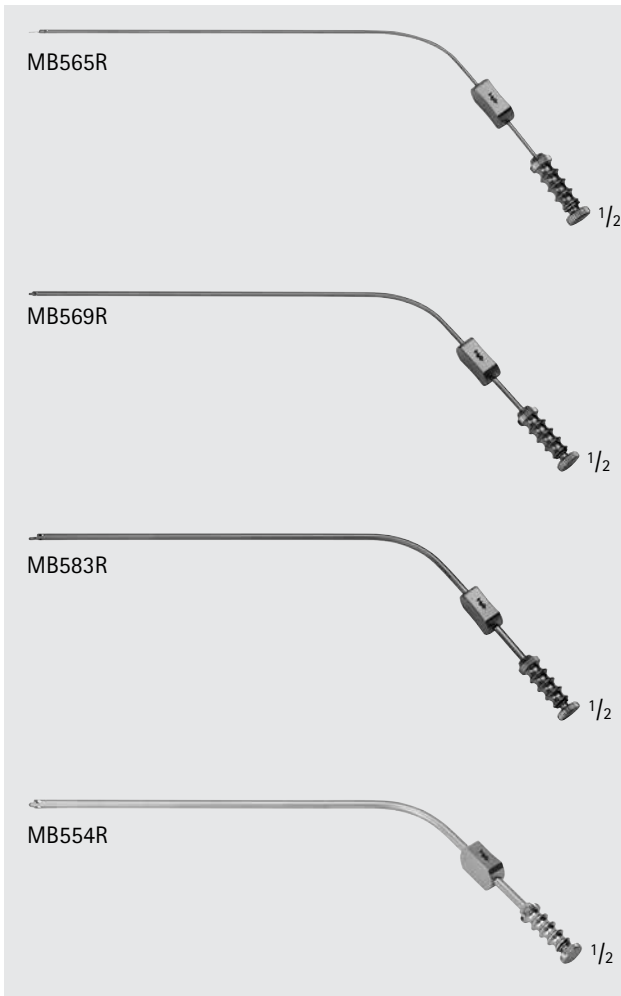

MB565R

1/2

MB569R

1/2

MB583R

1/2

MB554R

1/2

MCCULLOCH Suction Tube

Catalog Number	Tip Size (mm)	Length (in.)
MB708R	COMPLETE SET	5 3/4
MB565R	1.7	5 3/4
MB569R	2.3	5 3/4
MB583R	3.0	5 3/4
MB554R	4.0	5 3/4

MB708R Set of 4 Includes:

1 Suction cannula of each MB554R, MB565R, MB569R, MB583R

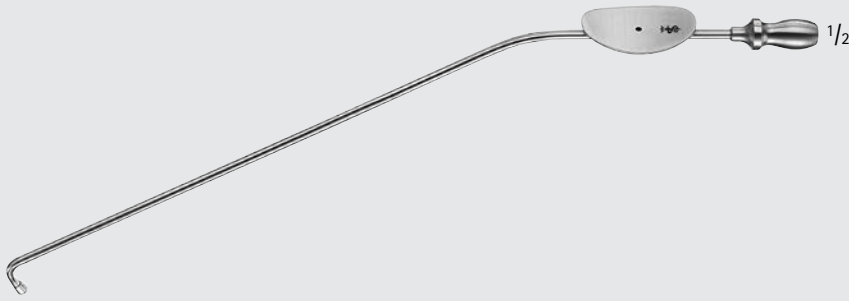

MF106R-MF111R

Atraumatic Suction Tube

Catalog Number	Tip	Tip Size (FR)	Length (in.)
MF106R	90° DOWN	5	8 1/2
MF107R	90° DOWN	7	8 1/2
MF108R	90° DOWN	10	8 1/2
MF109R	90° UP	5	8 1/2
MF110R	90° UP	7	8 1/2
MF111R	90° UP	10	8 1/2

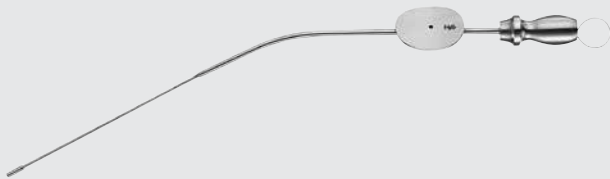

MF333R-MF347R

Atraumatic Suction Tube

Catalog Number	Tip Size (FR)	Working Length (in.)	Length (in.)
MF333R	3	3	6 1/4
MF334R	5	3	6 1/4
MF335R	7	3	6 1/4
MF336R	10	3	6 1/4
MF337R	12	3	6 1/4
MF338R	3	4	7 1/4
MF339R	5	4	7 1/4
MF340R	7	4	7 1/4
MF341R	10	4	7 1/4
MF342R	12	4	7 1/4
MF343R	3	5	8 1/4
MF344R	5	5	8 1/4
MF345R	7	5	8 1/4
MF346R	10	5	8 1/4
MF347R	12	5	8 1/4



Neurosurgery

Suction Cannulas

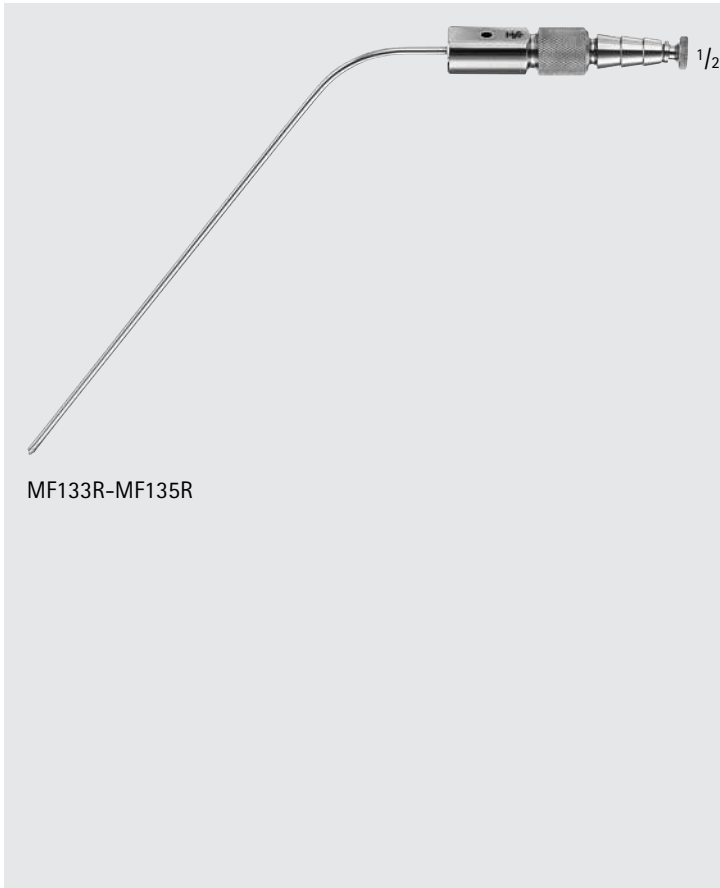
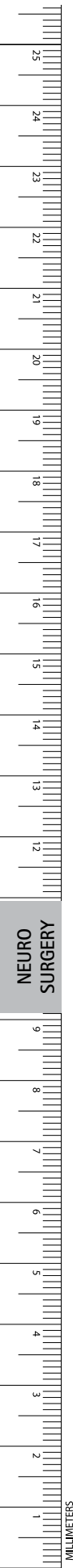

MF133R-MF135R

FRAZIER Suction Dissector

Catalog Number	Tip Size (FR)	Working Length (in.)
MF133R	5	6 1/2
MF134R	7	6 1/2
MF135R	10	6 1/2

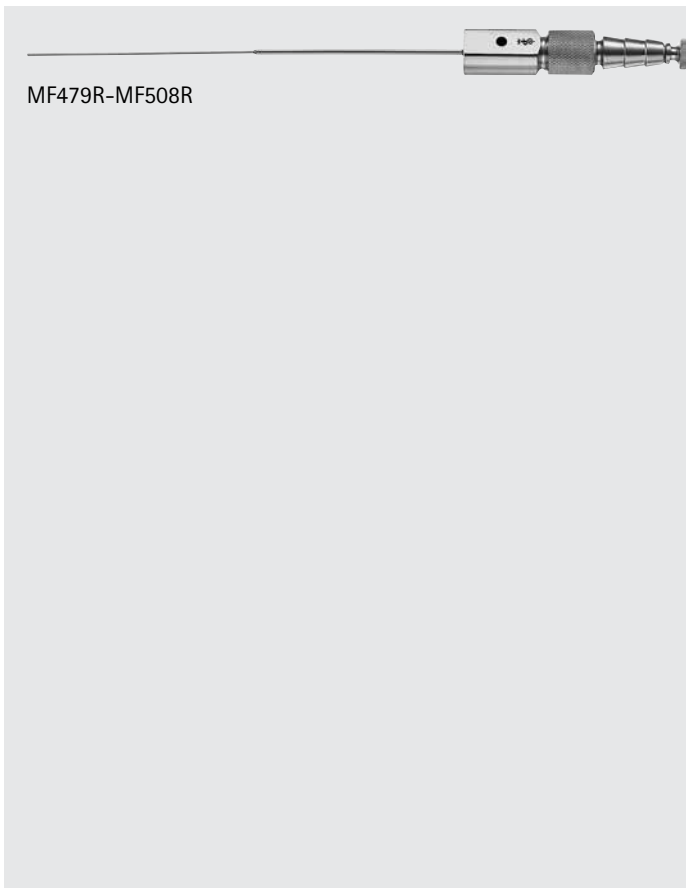

MF479R-MF508R

FRAZIER Slotted Suction Tube, Straight

Catalog Number	Tip Size (FR)	Length (in.)
MF479R	3	5 1/2
MF480R	4	5 1/2
MF481R	5	5 1/2
MF482R	6	5 1/2
MF483R	7	5 1/2
MF484R	8	5 1/2
MF485R	9	5 1/2
MF486R	10	5 1/2
MF487R	11	5 1/2
MF488R	12	5 1/2
MF499R	3	7
MF500R	4	7
MF501R	5	7
MF502R	6	7
MF503R	7	7
MF504R	8	7
MF505R	9	7
MF506R	10	7
MF507R	11	7
MF508R	12	7

NEURO SURGERY

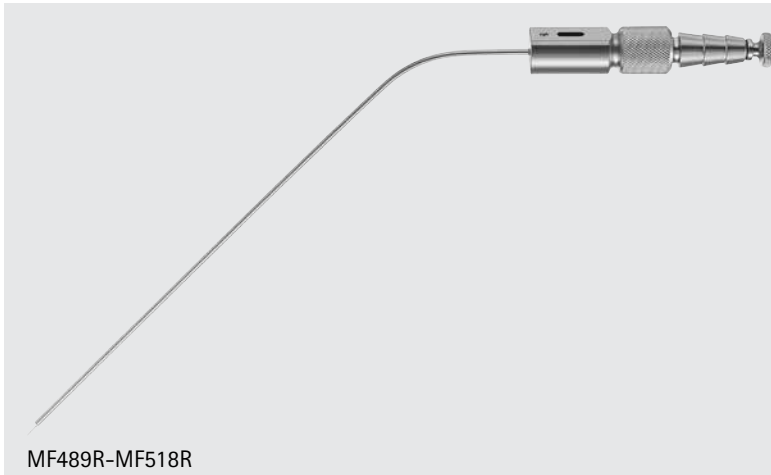

MF489R-MF518R

FRAZIER Slotted Suction Tube, Angled

Catalog Number	Tip Size (FR)	Length (in.)
MF489R	3	5 1/2
MF490R	4	5 1/2
MF491R	5	5 1/2
MF492R	6	5 1/2
MF493R	7	5 1/2
MF494R	8	5 1/2
MF495R	9	5 1/2
MF496R	10	5 1/2
MF497R	11	5 1/2
MF498R	12	5 1/2
MF509R	3	7
MF510R	4	7
MF511R	5	7
MF512R	6	7
MF513R	7	7
MF514R	8	7
MF515R	9	7
MF516R	10	7
MF517R	11	7
MF518R	12	7

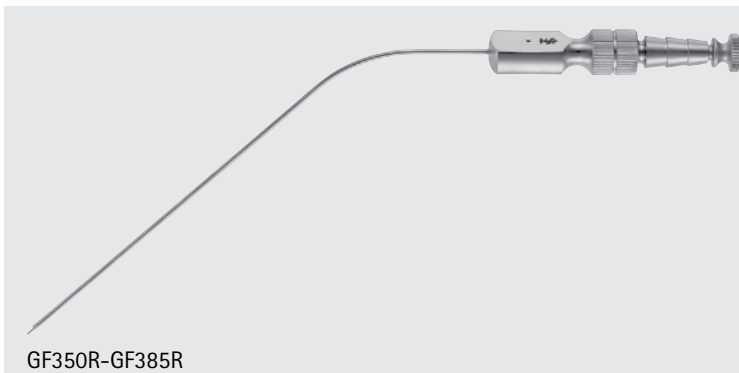

GF350R-GF385R

FERGUSON Suction Tube, Luer Hub

Catalog Number	Diameter (mm)	Working Length (in.)	Length (in.)
GF350R	1.5	4 1/4	7 3/4
GF351R	2.0	4 1/4	7 3/4
GF352R	2.5	4 1/4	7 3/4
GF353R	3.0	4 1/4	7 3/4
GF354R	4.0	4 1/4	7 3/4
GF355R	5.0	4 1/4	7 3/4
GF360R	1.5	5 1/8	8 1/2
GF361R	2.0	5 1/8	8 1/2
GF362R	2.5	5 1/8	8 1/2
GF363R	3.0	5 1/8	8 1/2
GF364R	4.0	5 1/8	8 1/2
GF365R	5.0	5 1/8	8 1/2
GF370R	1.5	6 1/4	9 5/8
GF371R	2.0	6 1/4	9 5/8
GF372R	2.5	6 1/4	9 5/8
GF373R	3.0	6 1/4	9 5/8
GF374R	4.0	6 1/4	9 5/8
GF375R	5.0	6 1/4	9 5/8
GF380R	1.5	7 7/8	11
GF381R	2.0	7 7/8	11
GF382R	2.5	7 7/8	11
GF383R	3.0	7 7/8	11
GF384R	4.0	7 7/8	11
GF385R	5.0	7 7/8	11

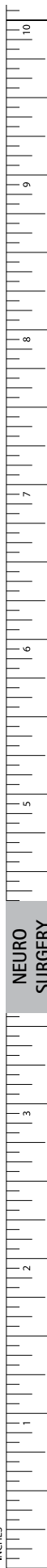

INCHES

Neurosurgery

Suction Cannulas



Diam. 4 mm
GF917R

Olive Diam. 9 mm 1/2

ADSON Suction Tube

Catalog Number	Tip Size (mm)	Tip Size (FR)	Length (in.)
GF917R	4	11	7 1/2

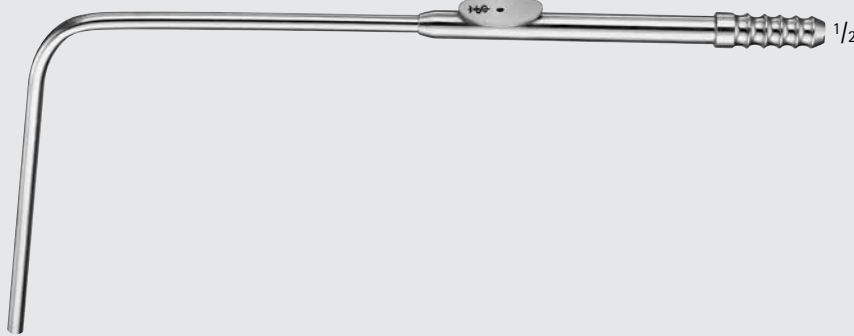

MB635R-MB636R

SACHS Suction Tube

Catalog Number	Tip Size (mm)	Length (in.)
MB635R	SMALL	8 1/2
MB636R	LARGE	8 1/2



FF125R

95 mm, 3 3/4"

1/2

CUSHING-CAIRNS Ventricular Cannula

Catalog Number	Diameter (mm)	Working Length (in.)
FF125R	2.3	3 3/4
FF126R	2.6	3 3/4

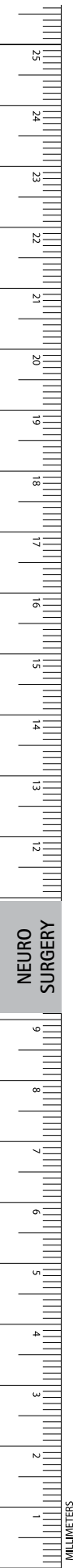

NEURO SURGERY

CASPAR Muscle Dissector

Catalog Number	Tip	Width (mm)	Length (in.)
FK328R	SHARP	6.2	7
FK329R	BLUNT	6.2	7

CUSHING Periosteal Elevator

Catalog Number	Tip	Width (mm)	Length (in.)
MF405R	ROUND, SHARP	15	7 1/4
MF406R	SQUARE, SHARP	15	7 1/4

HOEN Periosteal Elevator

Catalog Number	Tip Size (mm)	Length (in.)
MF326R	7.0	7 1/4
MF327R	15.0	7 1/4
MF328R	20.0	7 1/4

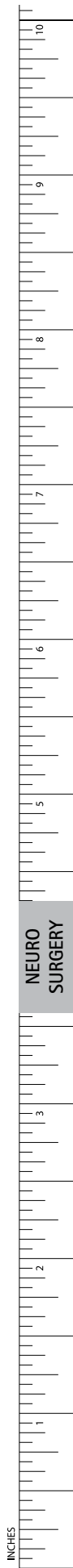

NEURO SURGERY

INCHES

Neurosurgery

Retractors and Handrest Systems



MF139R-MF141R

SCOVILLE Nerve Root Retractor

Catalog Number	Shape	Width (mm)	Working Length (in.)
MF139R	45°	8.0	4
MF140R	90°	8.0	4
MF141R	STR	8.0	7 1/4

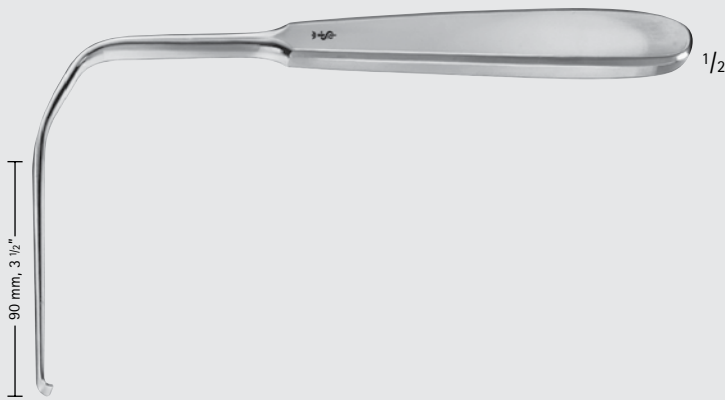

FF707R-FF709R

HESS Nerve Root Retractor

Catalog Number	Width (mm)	Working Length (in.)	Length (in.)
FF707R	3.0	3 1/2	6 7/8
FF708R	5.0	3 1/2	6 7/8
FF709R	7.0	3 1/2	6 7/8

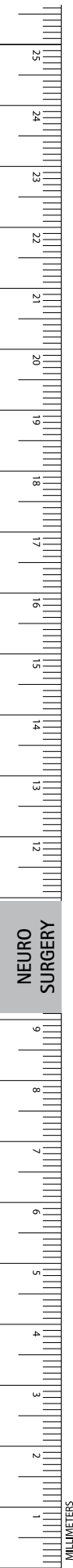

FF700R

FF700R

FF700R

Catalog Number	Length (in.)
FF700R	8 1/4

FF701R-FF703R

Catalog Number	Shape	Length (in.)
FF701R	STR	8 3/4
FF702R	45°	8 3/4
FF703R	90°	8 3/4

MF401R

MF401R

Catalog Number	Tip	Length (in.)
MF401R	ANG	8 1/4

MF402R-MF404R

Catalog Number	Tip	Blade	Length (in.)
MF402R	ANG	TOOTHED	8 1/2
MF403R	ANG	PLAIN	8 1/2
MF404R	ANG, SHARP	HOOK	8 1/2



Neurosurgery

Retractors and Handrest Systems

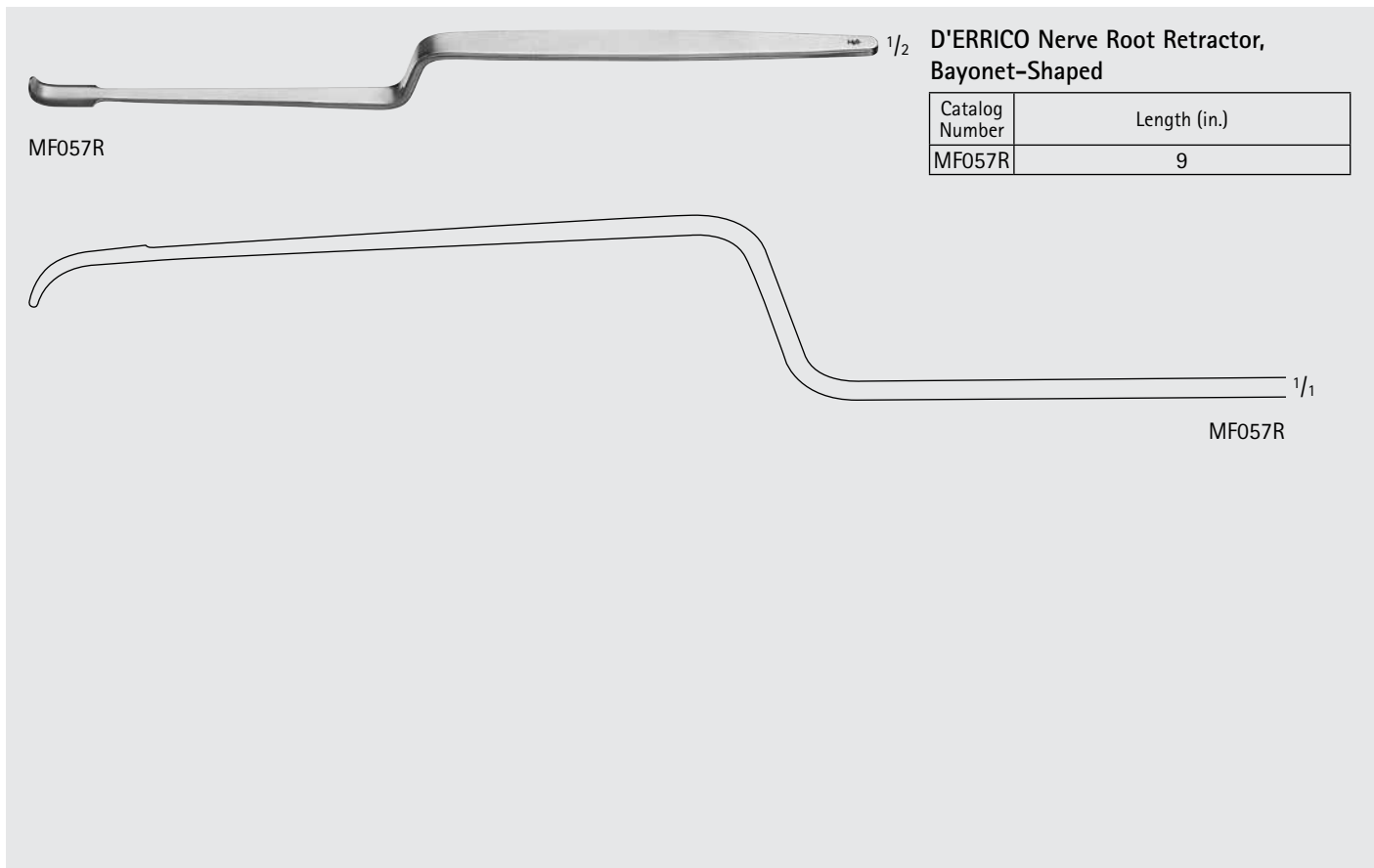
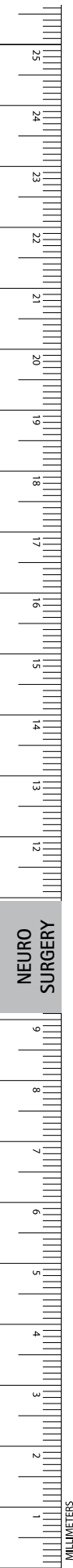

MF057R

D'ERRICO Nerve Root Retractor, Bayonet-Shaped

Catalog Number	Length (in.)
MF057R	9

MF057R

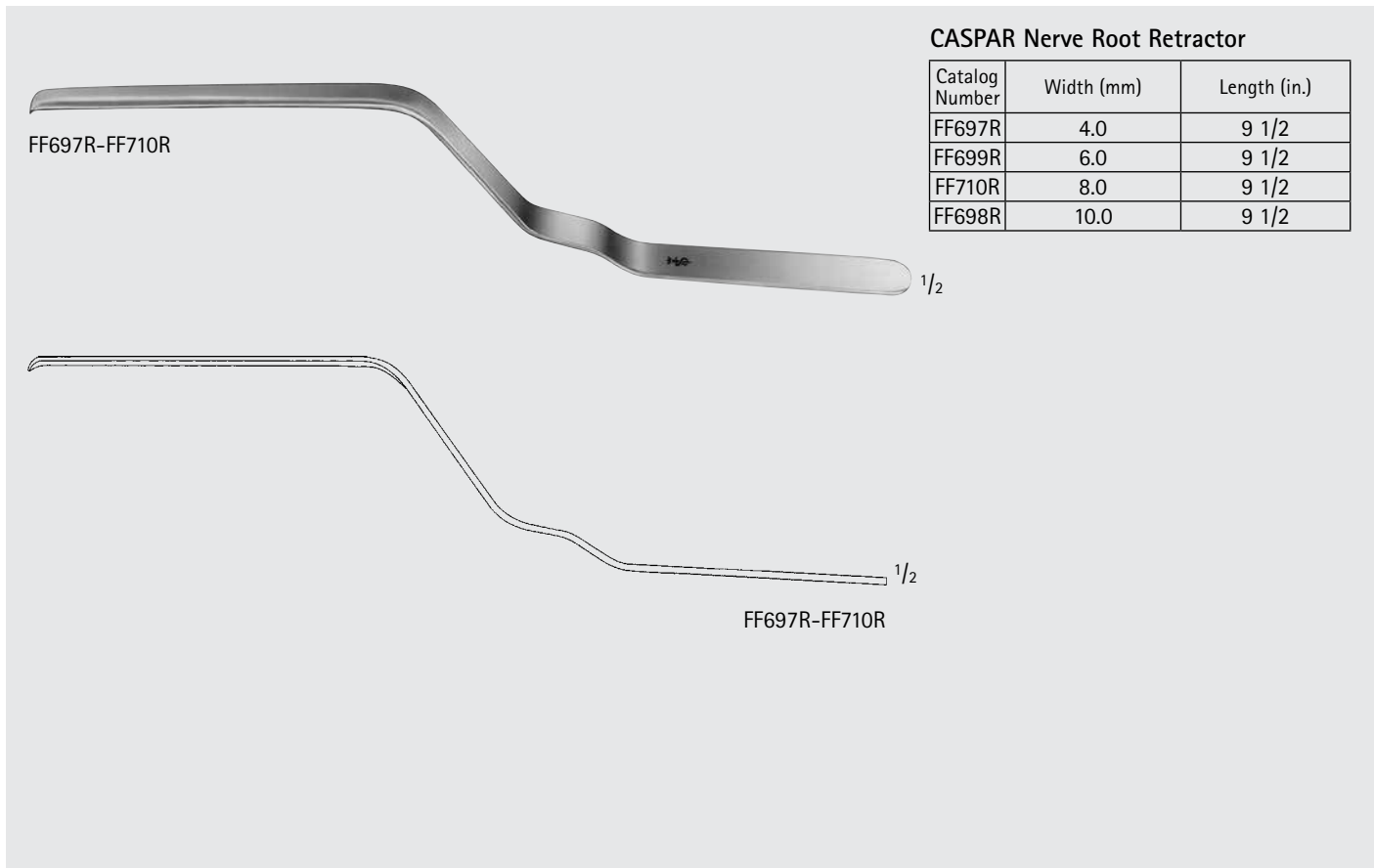

FF697R-FF710R

CASPAR Nerve Root Retractor

Catalog Number	Width (mm)	Length (in.)
FF697R	4.0	9 1/2
FF699R	6.0	9 1/2
FF710R	8.0	9 1/2
FF698R	10.0	9 1/2

FF697R-FF710R



FF280R-FF286R

**Ball and Socket Joint, F/ Holding Rod
FF285R**

Catalog Number	Size (mm)
FF280R	10 x 25
FF286R	9 x 32



FF285R

**Holding Rod, F/ Ball and Socket Joint
FF280R**

Catalog Number	Compatible w/
FF285R	FF282R, FF283R or FF284R



FF282R

**Coupling Head, F/ Up to 5 Flexible
Arms FF270R**

Catalog Number
FF282R



FF283R

**Coupling Head, F/ Flexible Arm FF270R,
Rotatable**

Catalog Number
FF283R

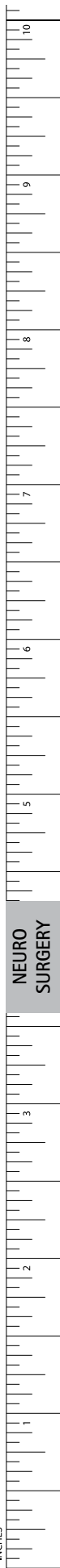

Neurosurgery

Retractors and Handrest Systems



Coupling Head, F/ Flexible Arm FF270R, Rotatable, Laterally Open

Catalog Number
FF284R

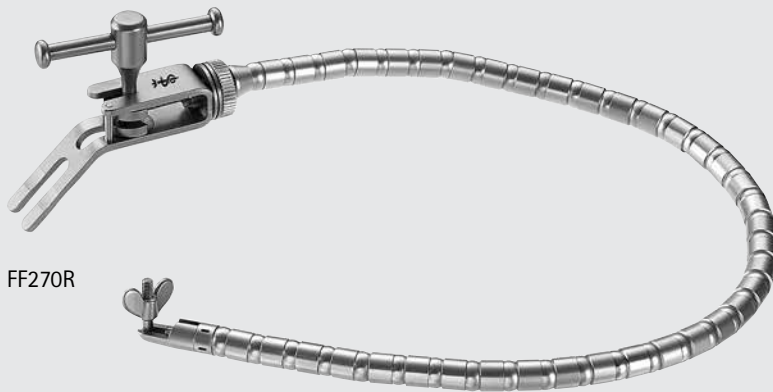

YASARGIL Flexible Arm

Catalog Number	Description
FF270R	COUPLING HEADS: FF282R, FF283R, FF284R FIXATION BASES: FF266R, FF267R, FF268R



Support for Brain Spatula, F/ Flexible Arm FF270R

Catalog Number
FF273R



Support for Brain Spatula, W/ Round Shaft, F/ Flexible Arm FF270R

Catalog Number
FF274R

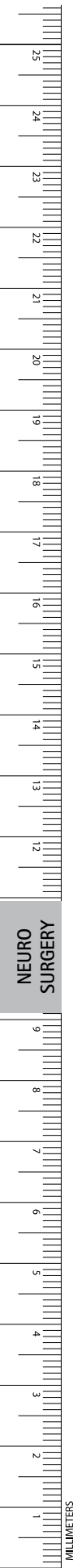

NEURO SURGERY

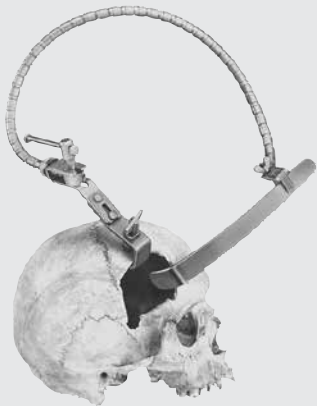

FF260R

YASARGIL Self-Retaining Retractor, W/ 1 Flexible Arm

Catalog Number
FF260R

FF260R Includes:

- 1 Fixation base FF266R,
- 1 Flexible arm FF270R and
- 1 Support for brain spatula FF273R

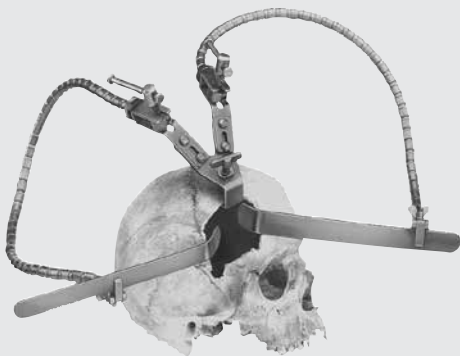

FF262R

YASARGIL Self-Retaining Retractor, W/ 2 Flexible Arms

Catalog Number
FF262R

FF262R Includes:

- 1 Fixation base FF268R,
- 2 Flexible arms FF270R and
- 2 Supports for brain spatulas FF273R



FF266R

Fixation Base, F/ Skull Mounting, Holds 1 Flexible Arm FF260R

Catalog Number
FF266R

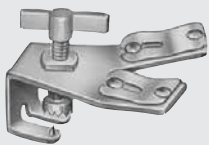

FF268R

Fixation Base, F/ Skull Mounting, Hold 2 Flexible Arms FF270R

Catalog Number
FF268R

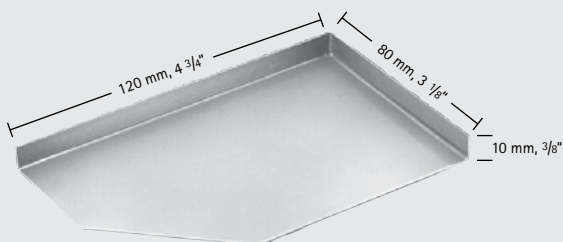

FF180R

Utility Tray

Catalog Number	Compatible w/	Width (in.)	Length (in.)
FF180R	FLEXIBLE ARMS FF270R AND FF273R	3 1/8	4 3/4



Neurosurgery

Retractors and Handrest Systems

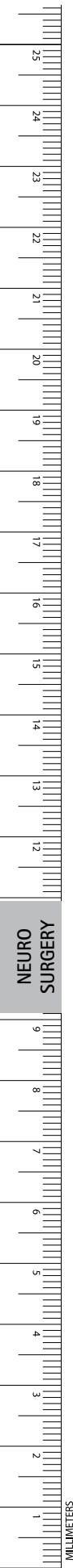

NEW JERSEY Flexible Arm

Catalog Number
FF431R

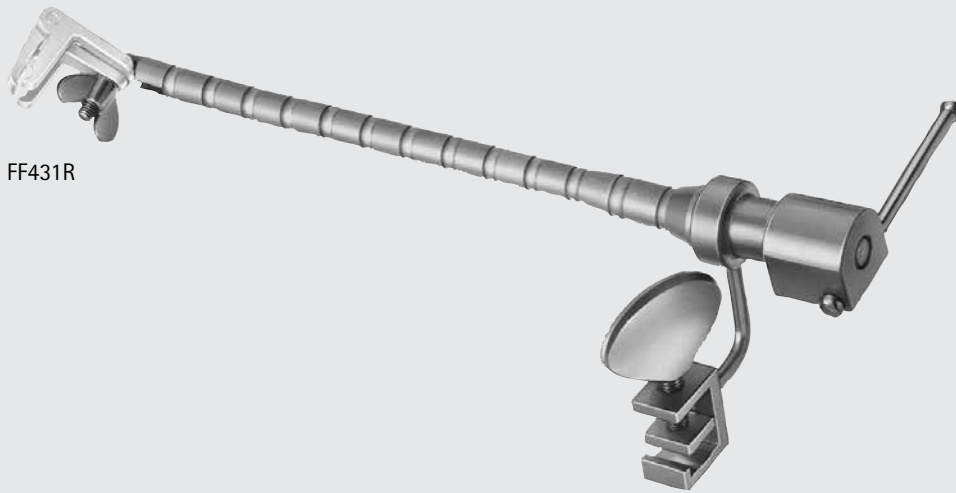

FF431R

Table Attachment

Catalog Number	Compatible w/
FF151R	FF150R



FF151R

GILSBACH Basic Unit

Catalog Number	Description
FF150R	COMPLETE BASIC UNIT
FF152R	GILSBACH INSULATING HOLDING ROD
FF153R	GILSBACH SEMI-CIRCULAR BASIC BAR
FF154R	FRAME FOR GALEA HOOK

FF150R Includes:
 1 Insulated holding rod FF152R
 1 Semi-circular basic bar FF153R
 1 Frame FF154R for Galea hook

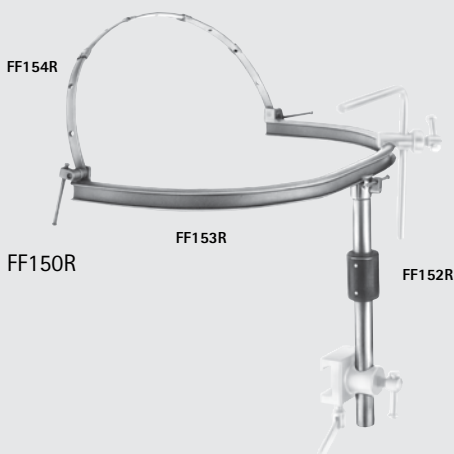

FF154R

FF150R

FF153R

FF152R

Neurosurgery

Retractors and Handrest Systems

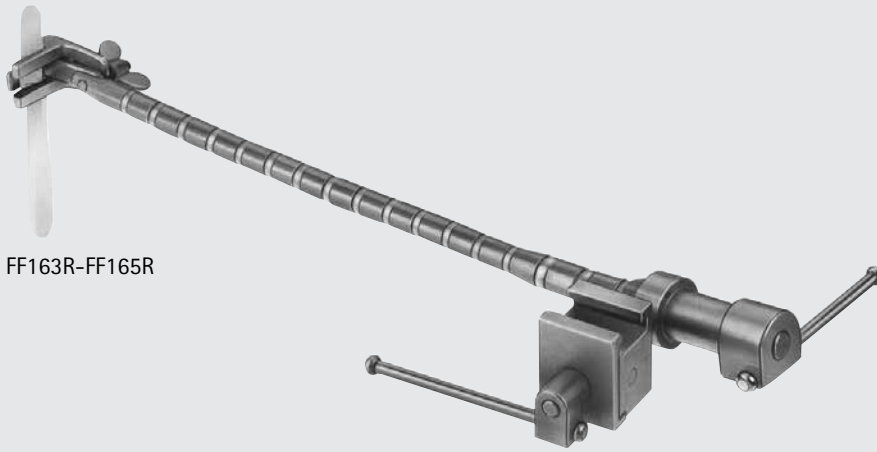

FF163R-FF165R

GILSBACH Flexible Arm

Catalog Number	Length (in.)
FF163R	7 7/8
FF165R	9 3/4



FF185R

Forceps Holder

Catalog Number	Compatible w/
FF185R	FF153R

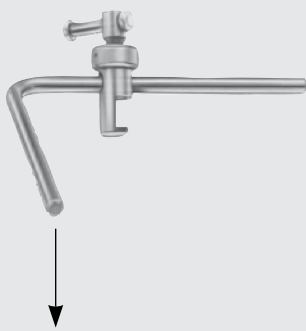

FF187R

GILSBACH Handrest, Adjustable Height

Catalog Number	Compatible w/
FF187R	FF153R



NEURO SURGERY

INCHES

Neurosurgery

Retractors and Handrest Systems



GILSBACH Holding Rod, F/ MAYFIELD Head Holder

Catalog Number	Description
FF190R	COMPLETE HOLDING DEVICE
FF191R	HOLDING ROD TO BE FIXED TO MAYFIELD HEAD HOLDER
FF193R	CONNECTION PIECE TO BE MOUNTED TO HOLDING ROD FF191R

FF191R Connection Piece is compatible with FF152R, FF191R and FF285R holding rods

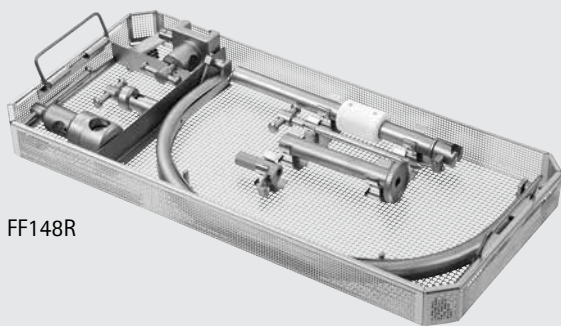

Storage Basket for GILSBACH Basic Unit

Catalog Number	Dimensions (mm)
FF148R	540 x 253 x 56

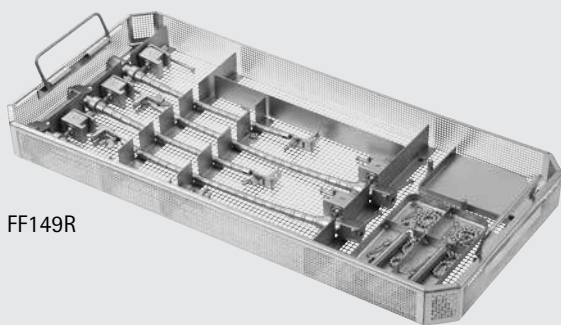

Storage Basket for GILSBACH Flexible Arms

Catalog Number	Dimensions (mm)
FF149R	540 x 254 x 50

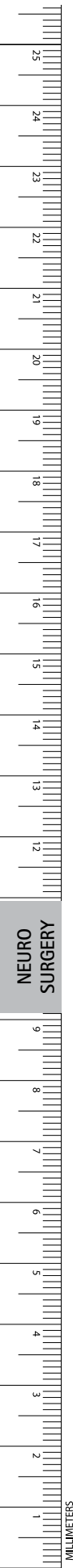

NEURO SURGERY



FF480R-FF488R

Silicone Brain Spatula, Flat, Single Use

Catalog Number	Blade Size (mm)	Packaging	Length (in.)
FF480R	6.0	BOX OF 10	7 7/8
FF482R	7.5	BOX OF 10	7 7/8
FF484R	10.0	BOX OF 10	7 7/8
FF486R	12.5	BOX OF 10	7 7/8
FF488R	15.0	BOX OF 10	7 7/8

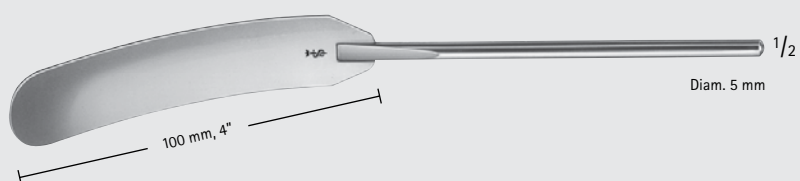

FF231R-FF233R

Malleable Brain Spatula W/ Round Shaft for FF274R

Catalog Number	Working Length (in.)	Blade Size (mm)	Diameter (mm)	Length (in.)
FF231R	4	14	5.0	7 7/8
FF232R	4	17	5.0	7 7/8
FF233R	4	20	5.0	7 7/8



FF256R-FF259R

HEIFETZ Malleable Brain Spatula W/ Round Shaft for FF274R

Catalog Number	Working Length (in.)	Blade Size (mm)	Diameter (mm)	Length (in.)
FF256R	4	8	3.5	6 1/8
FF257R	4	11	3.5	6 1/8
FF258R	4	14	3.5	6 1/8
FF259R	4	17	3.5	6 1/8

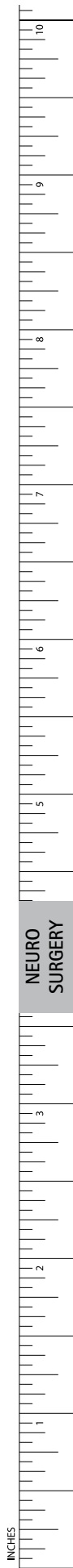

Neurosurgery

Brain Spatulas



FF441R-FF446R

AACHEN (MARTIN) Brain Spatula, Malleable

Catalog Number	Blade Size (mm)	Length (in.)
FF441R	7 x 8	7 7/8
FF442R	10 x 11	7 7/8
FF443R	13 x 14	7 7/8
FF444R	16 x 17	7 7/8
FF445R	19 x 20	7 7/8
FF446R	22 x 25	7 7/8



FF201R-FF222R

Brain Spatula, Flat, Malleable

Catalog Number	Blade Size (mm)	Length (in.)
FF201R	9	7 7/8
FF202R	12	7 7/8
FF222R	12	9 3/4



FF211R-FF214R

Brain Spatula, Flat, Malleable

Catalog Number	Blade Size (mm)	Length (in.)
FF211R	7 x 9	7
FF212R	11 x 13	7
FF213R	15 x 18	7
FF214R	18 x 22	7



FF216R-FF217R

OLIVECRONA Brain Spatula, Flat, Malleable

Catalog Number	Blade Size (mm)	Length (in.)
FF216R	7 x 9	7
FF217R	11 x 13	7

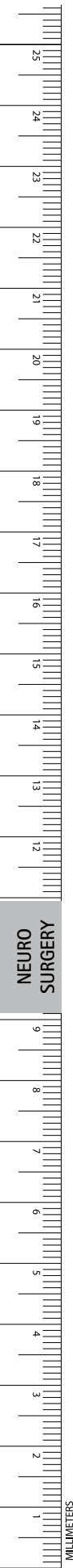



MD111-MD116

DAVIS Brain Spatula, Flat, Malleable

Catalog Number	Blade Size (mm)
MD111	6.0
MD112	9.0
MD113	13.0
MD114	16.0
MD115	19.0
MD116	25.0



MF348R-MF355R

Silicone Coated Brain Spatula, Post

Catalog Number	Blade Size (mm)	Length (in.)
MF348R	6.0	5 3/4
MF350R	8.0	5 3/4
MF349R	10.0	5 3/4
MF352R	11.0	5 3/4
MF354R	14.0	5 3/4
MF351R	15.0	5 3/4
MF353R	20.0	5 3/4
MF355R	25.0	5 3/4



MF356R-MF359R

Silicone Coated Brain Spatula

Catalog Number	Blade Size (mm)	Length (in.)
MF356R	10 x 6	6 3/4
MF357R	15 x 8	6 3/4
MF358R	20 x 11	6 3/4
MF359R	25 x 14	6 3/4

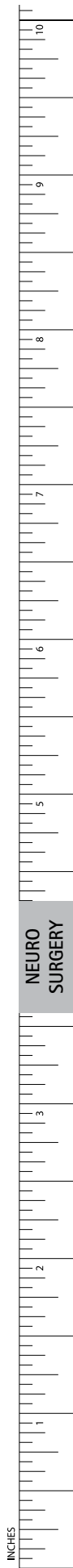

Neurosurgery

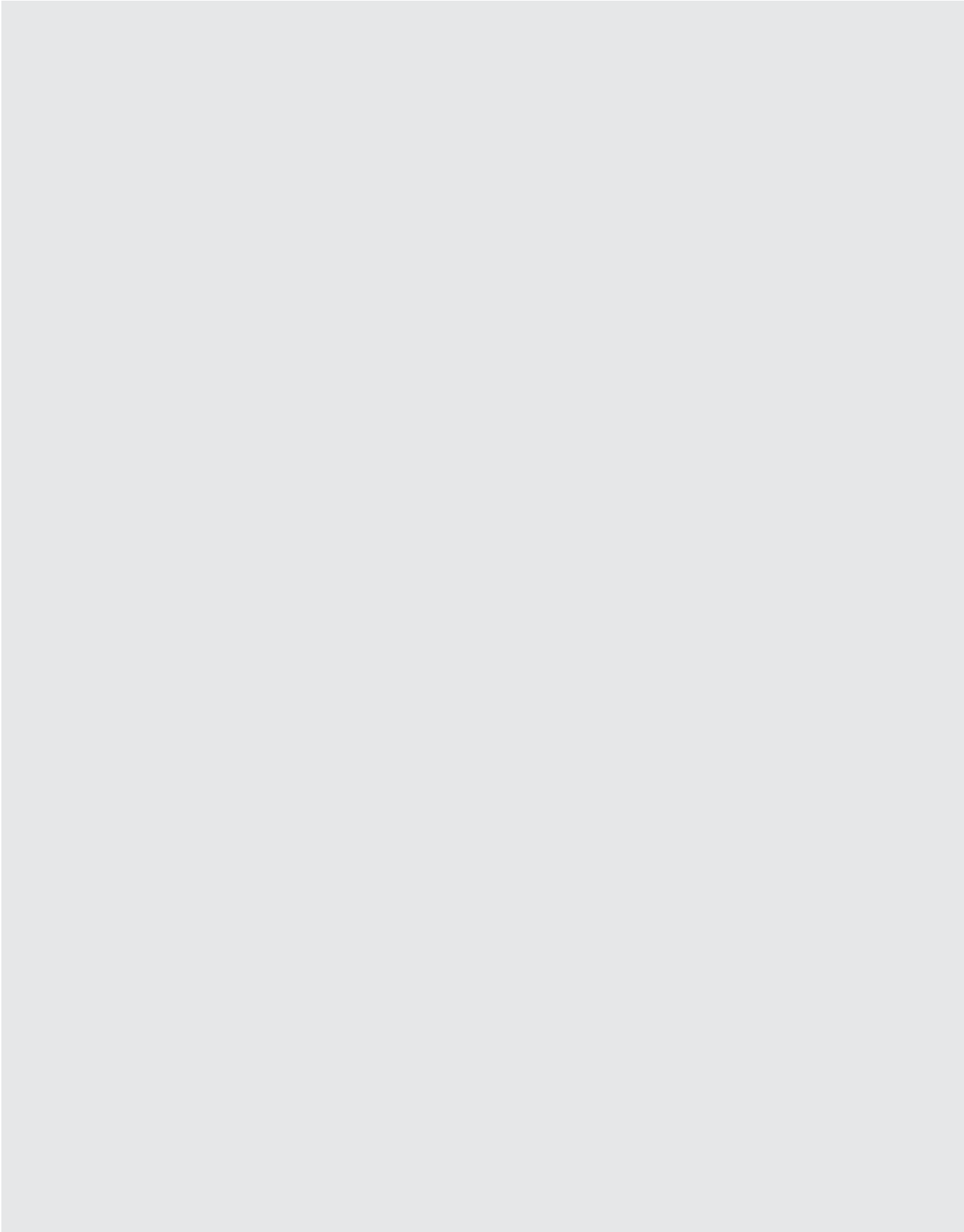
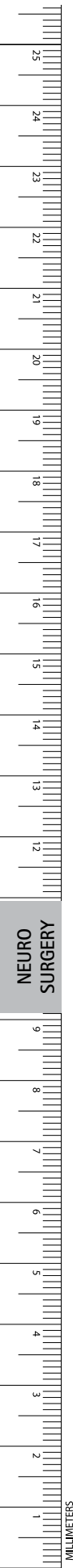

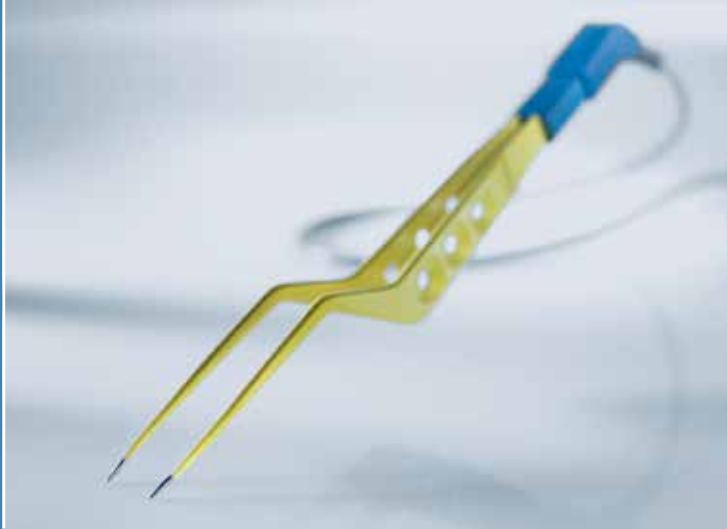

Electrosurgery

BipoJET® Bipolar Scissors	1168
Non-Irrigating Bipolar Forceps	1169 - 1190
Irrigating Bipolar Forceps	1191 - 1194
Disposable Bipolar Forceps	1195 - 1197
Bipolar Connecting Cords	1198 - 1200

Electrosurgery

BipoJET® Bipolar Scissors

The versatility of BipoJET Dissecting Bipolar Scissors enables:

■ **Parallel Cutting and Coagulating**

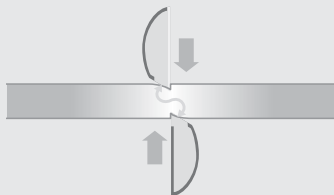

■ **Precoagulation**



■ **Pinpoint Coagulation**



■ **Surface Coagulation**

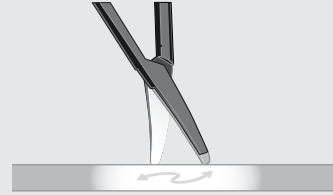

For more information about Bipolar Scissors see our brochure number **DOC456**.
See page 1199-1200 for appropriate connecting cords.



BC691R-BC693R



BC691R-BC693R 1/1

METZENBAUM Bipolar Dissecting Scissors

Catalog Number	Tip	Length (in.)
BC691R	X-FINE	4 3/4
BC692R	X-FINE	5 1/2
BC693R	X-FINE	6 1/4



BC694R-BC696R



BC694R-BC696R 1/1

STEVENS Bipolar Dissecting Scissors

Catalog Number	Tip	Length (in.)
BC694R	TENOTOMY	4 3/4
BC695R	TENOTOMY	5 1/2
BC696R	TENOTOMY	6 1/4



BC685R-BC690R



BC685R 1/1



BC686R 1/1

METZENBAUM Bipolar Dissecting Scissors

Catalog Number	Tip	Length (in.)
BC685R	STANDARD	7
BC687R	STANDARD	9
BC689R	STANDARD	11
BC686R	FINE	7
BC688R	FINE	9
BC690R	FINE	11

Electrosurgery

Non-Irrigating Bipolar Forceps

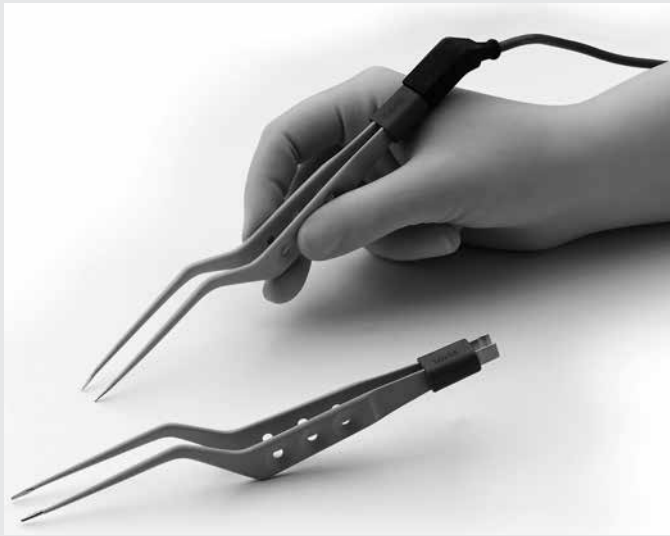

YASARGIL Bipolar Forceps Features:

- High precision, tissue preserving preparation instrument
- Stronger tension of the forceps allows for blunt spreading of the tissue.

Tip Size Reference Chart

0.2 mm		0.8 mm	
0.25 mm		0.9 mm	
0.4 mm		1.0 mm	
0.5 mm		1.3 mm	
0.6 mm		1.5 mm	
0.7 mm		2.0 mm	

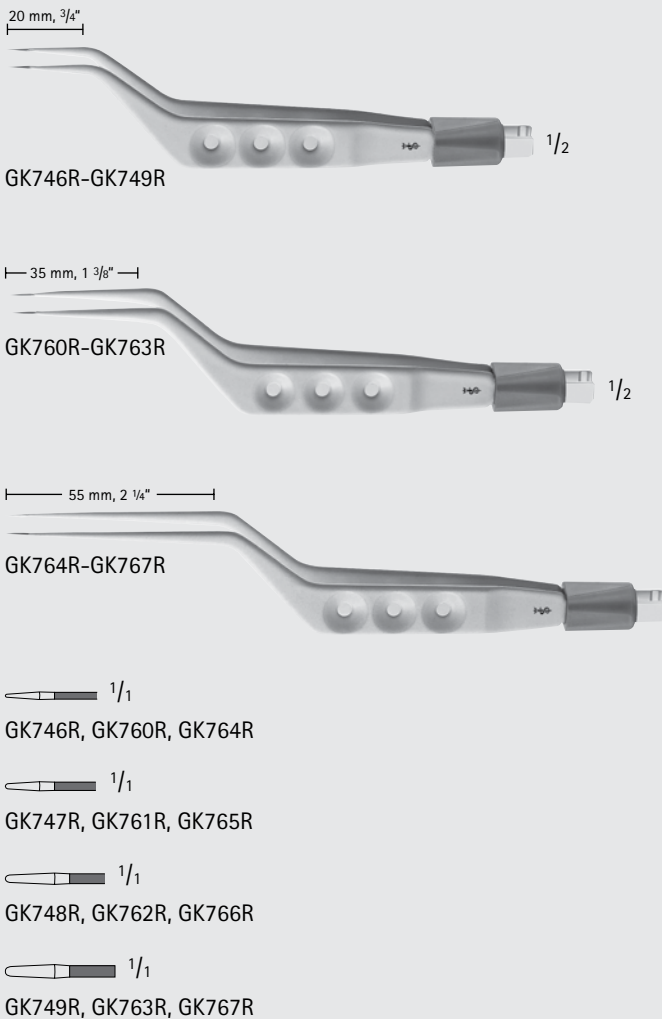

YASARGIL Style Bipolar Forceps, Stainless Steel

Catalog Number	Tip Size (mm)	Shape	Insulation	Irrigation	Working Length (in.)	Length (in.)
GK746R	0.4	BAYONET	INS*	NON-IRRIG*	3/4	5 1/2
GK747R	0.7	BAYONET	INS	NON-IRRIG	3/4	5 1/2
GK748R	1.0	BAYONET	INS	NON-IRRIG	3/4	5 1/2
GK749R	1.3	BAYONET	INS	NON-IRRIG	3/4	5 1/2
GK760R	0.4	BAYONET	INS	NON-IRRIG	1 3/8	6 1/8
GK761R	0.7	BAYONET	INS	NON-IRRIG	1 3/8	6 1/8
GK762R	1.0	BAYONET	INS	NON-IRRIG	1 3/8	6 1/8
GK763R	1.3	BAYONET	INS	NON-IRRIG	1 3/8	6 1/8
GK764R	0.4	BAYONET	INS	NON-IRRIG	2 1/4	6 7/8
GK765R	0.7	BAYONET	INS	NON-IRRIG	2 1/4	6 7/8
GK766R	1.0	BAYONET	INS	NON-IRRIG	2 1/4	6 7/8
GK767R	1.3	BAYONET	INS	NON-IRRIG	2 1/4	6 7/8

* Key:
 INS = Insulating
 NON-IRRIG = Non-Irrigating
 IRRIG = Irrigating

Electrosurgery

Non-Irrigating Bipolar Forceps

YASARGIL Style Bipolar Forceps, Stainless Steel

Catalog Number	Tip Size (mm)	Shape	Insulation	Irrigation	Working Length (in.)	Length (in.)
GK768R	0.4	BAYONET	INS	NON-IRRIG	3	7 3/4
GK769R	0.7	BAYONET	INS	NON-IRRIG	3	7 3/4
GK770R	1.0	BAYONET	INS	NON-IRRIG	3	7 3/4
GK771R	1.3	BAYONET	INS	NON-IRRIG	3	7 3/4
GK772R	0.4	BAYONET	INS	NON-IRRIG	3 3/4	8 1/2
GK773R	0.7	BAYONET	INS	NON-IRRIG	3 3/4	8 1/2
GK774R	1.0	BAYONET	INS	NON-IRRIG	3 3/4	8 1/2
GK775R	1.3	BAYONET	INS	NON-IRRIG	3 3/4	8 1/2

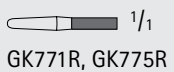
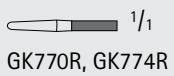
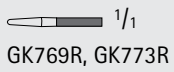
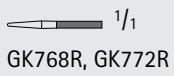
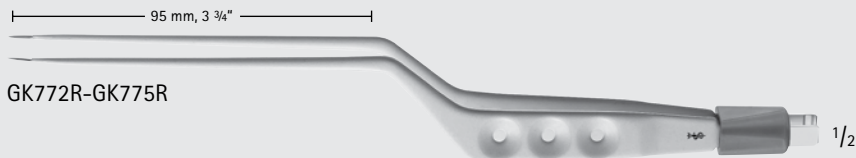
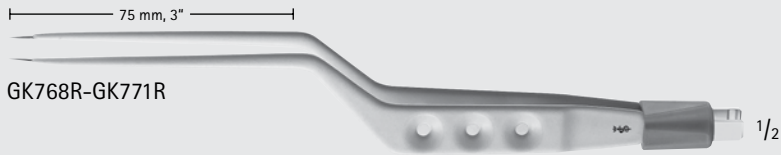

ELECTRO SURGERY

MILLIMETERS

Electrosurgery

Non-Irrigating Bipolar Forceps

YASARGIL Style Bipolar Forceps, Stainless Steel

Catalog Number	Tip Size (mm)	Shape	Insulation	Irrigation	Working Length (in.)	Length (in.)
GK788R	0.4	BAYONET	INS	NON-IRRIG	4 1/2	9 1/4
GK789R	0.7	BAYONET	INS	NON-IRRIG	4 1/2	9 1/4
GK790R	1.0	BAYONET	INS	NON-IRRIG	4 1/2	9 1/4
GK791R	1.3	BAYONET	INS	NON-IRRIG	4 1/2	9 1/4
GK793R	0.7	BAYONET	INS	NON-IRRIG	5 1/4	10

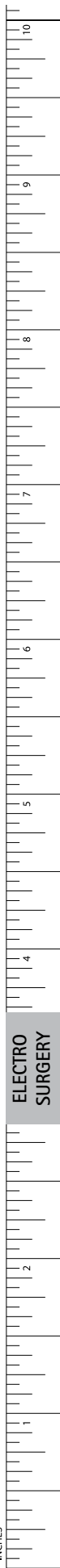
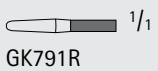
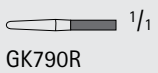
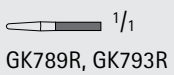
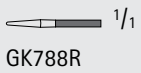
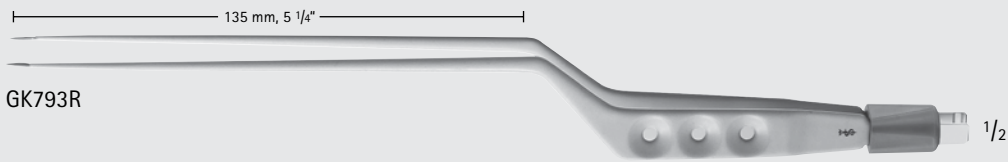
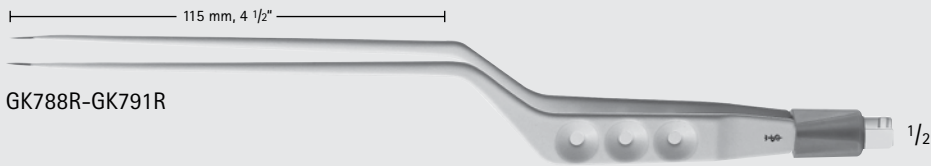

ELECTRO SURGERY

INCHES

Electrosurgery

Non-Irrigating Bipolar Forceps

YASARGIL Style Bipolar Forceps, Stainless Steel

Catalog Number	Tip	Tip Size (mm)	Shape	Insulation	Irrigation	Working Length (in.)	Length (in.)
GK777R	45° UP	0.7	BAYONET	INS	NON-IRRIG	3 3/4	8 1/2
GK780R	90° UP	0.4	BAYONET	INS	NON-IRRIG	3 3/4	8 1/2
GK781R	90° UP	0.7	BAYONET	INS	NON-IRRIG	3 3/4	8 1/2
GK785R	90° DOWN	0.7	BAYONET	INS	NON-IRRIG	3 3/4	8 1/2

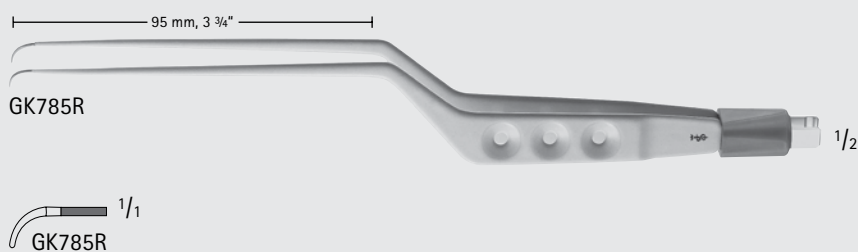
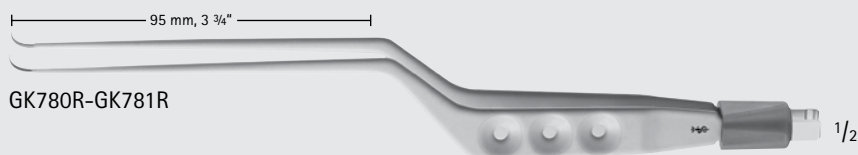
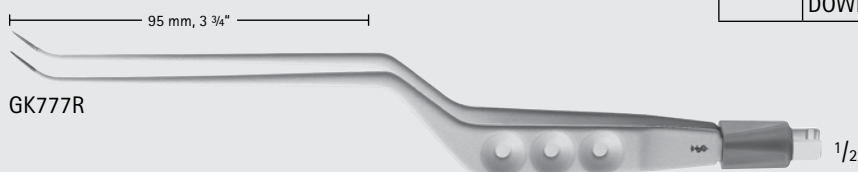

YASARGIL Style Bipolar Forceps

Catalog Number	Tip	Tip Size (mm)	Working Length (in.)	Length (in.)
GK831R	RING	2/3	4 1/2	9 1/4
GK832R	RING	3/4	4 1/2	9 1/4
GK833R	RING	4/5	4 1/2	9 1/4

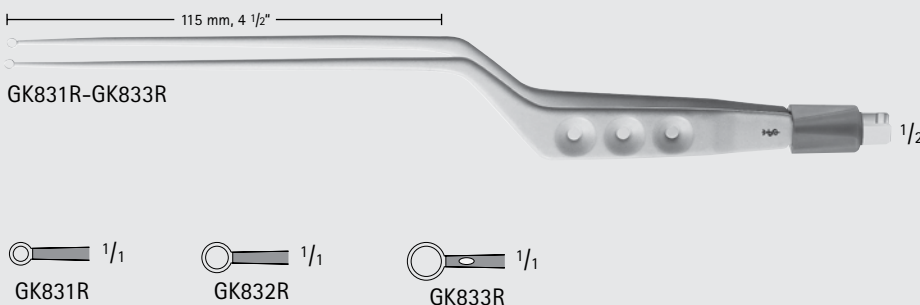

Electrosurgery

Non-Irrigating Bipolar Forceps

Bipolar Forceps, Stainless Steel

Catalog Number	Tip Size (mm)	Shape	Insulation	Irrigation	Working Length (in.)	Length (in.)
GK660R	0.6	BAYONET	INS	NON-IRRIG	1 1/2	6 1/4
GK670R	0.6	BAYONET	INS	NON-IRRIG	3 1/8	7 7/8
GK671R	0.9	BAYONET	INS	NON-IRRIG	3 1/8	7 7/8
GK675R	0.6	BAYONET	INS	NON-IRRIG	4	8 3/4
GK677R	0.6	BAYONET	INS	NON-IRRIG	4 3/4	9 1/2
GK679R	0.9	BAYONET	INS	NON-IRRIG	4 3/4	9 1/2

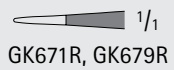
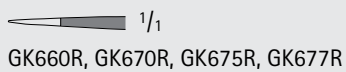

ELECTRO SURGERY

INCHES

Electrosurgery

Non-Irrigating Bipolar Forceps

Bayonet Forceps, Rose Gold, Insulated

■ Rose Gold plated tips reduce tissue adhesion



Non-Stick Rose Gold forceps

The Rose Gold forceps enable heat to be quickly discharged away from the tip.



Standard forceps

The heat cannot be discharged fast enough. This leads to overheating and sticking of tissue.

Rose Gold Bipolar Forceps, Bayonet-Shaped

Catalog Number	Tip Size (mm)	Style	Insulation	Irrigation	Working Length (in.)	Length (in.)
US403	0.5	HARDY	INS	NON-IRRG	2	6
US404	0.7	HARDY	INS	NON-IRRG	2	6
US405	1.0	HARDY	INS	NON-IRRG	2	6
US406	1.5	HARDY	INS	NON-IRRG	2	6
US407	2.0	HARDY	INS	NON-IRRG	2	6
US605	0.5	SCOVILLE	INS	NON-IRRG	2 3/4	7 3/4
US606	0.7	SCOVILLE	INS	NON-IRRG	2 3/4	7 3/4
US607	1.0	SCOVILLE	INS	NON-IRRG	2 3/4	7 3/4
US608	1.5	SCOVILLE	INS	NON-IRRG	2 3/4	7 3/4
US609	2.0	SCOVILLE	INS	NON-IRRG	2 3/4	7 3/4
US600	0.5	CUSHING	INS	NON-IRRG	3 1/2	7 1/2
US601	0.7	CUSHING	INS	NON-IRRG	3 1/2	7 1/2
US602	1.0	CUSHING	INS	NON-IRRG	3 1/2	7 1/2
US603	1.5	CUSHING	INS	NON-IRRG	3 1/2	7 1/2
US604	2.0	CUSHING	INS	NON-IRRG	3 1/2	7 1/2
US610	0.5	HARDY	INS	NON-IRRG	4 1/2	8 1/2
US611	0.7	HARDY	INS	NON-IRRG	4 1/2	8 1/2
US612	1.0	HARDY	INS	NON-IRRG	4 1/2	8 1/2
US613	1.5	HARDY	INS	NON-IRRG	4 1/2	8 1/2
US614	2.0	HARDY	INS	NON-IRRG	4 1/2	8 1/2
US615	0.5	HARDY	INS	NON-IRRG	5	9
US616	0.7	HARDY	INS	NON-IRRG	5	9
US617	1.0	HARDY	INS	NON-IRRG	5	9
US618	1.5	HARDY	INS	NON-IRRG	5	9
US619	2.0	HARDY	INS	NON-IRRG	5	9
US530	0.5	HARDY	INS	NON-IRRG	6	10
US620	0.7	HARDY	INS	NON-IRRG	6	10
US621	1.0	HARDY	INS	NON-IRRG	6	10
US173	1.5	HARDY	INS	NON-IRRG	6	10
US531	2.0	HARDY	INS	NON-IRRG	6	10

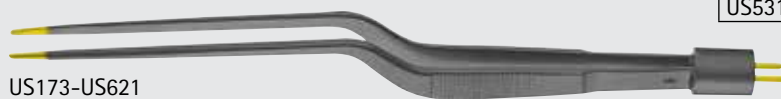



US173-US621

 1/1
US403, US530, US600, US610, US615

 1/1
US404, US601, US611, US616, US621

 1/1
US405, US602, US612, US617

 1/1
US173, US406, US603, US613, US618

 1/1
US407, US531, US604, US614, US619

Electrosurgery

Non-Irrigating Bipolar Forceps

Rose Gold Microform Bipolar Forceps

Catalog Number	Tip Size (mm)	Shape	Insulation	Irrigation	Working Length (in.)	Length (in.)
US526	0.5	BAYONET	INS	NON-IRRG	1 3/8	6
US527	0.7	BAYONET	INS	NON-IRRG	1 3/8	6
US528	1.0	BAYONET	INS	NON-IRRG	1 3/8	6
US529	1.3	BAYONET	INS	NON-IRRG	1 3/8	6
US570	0.5	BAYONET	INS	NON-IRRG	2 3/8	7
US571	0.7	BAYONET	INS	NON-IRRG	2 3/8	7
US572	1.0	BAYONET	INS	NON-IRRG	2 3/8	7
US573	1.3	BAYONET	INS	NON-IRRG	2 3/8	7
US574	0.5	BAYONET	INS	NON-IRRG	3	7 3/4
US575	0.7	BAYONET	INS	NON-IRRG	3	7 3/4
US576	1.0	BAYONET	INS	NON-IRRG	3	7 3/4
US577	1.3	BAYONET	INS	NON-IRRG	3	7 3/4
US578	0.5	BAYONET	INS	NON-IRRG	3 3/4	8 1/2
US579	0.7	BAYONET	INS	NON-IRRG	3 3/4	8 1/2
US580	1.0	BAYONET	INS	NON-IRRG	3 3/4	8 1/2
US581	1.3	BAYONET	INS	NON-IRRG	3 3/4	8 1/2
US582	0.5	BAYONET	INS	NON-IRRG	4 1/2	9 1/4
US583	0.7	BAYONET	INS	NON-IRRG	4 1/2	9 1/4
US584	1.0	BAYONET	INS	NON-IRRG	4 1/2	9 1/4
US585	1.3	BAYONET	INS	NON-IRRG	4 1/2	9 1/4
US586	0.5	BAYONET	INS	NON-IRRG	5 1/2	10 1/4
US587	0.7	BAYONET	INS	NON-IRRG	5 1/2	10 1/4
US588	1.0	BAYONET	INS	NON-IRRG	5 1/2	10 1/4
US589	1.3	BAYONET	INS	NON-IRRG	5 1/2	10 1/4

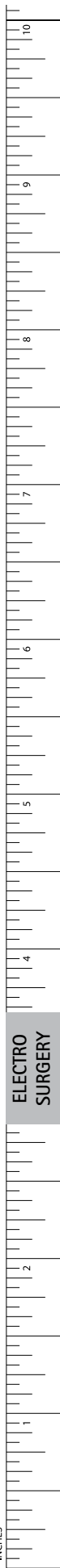

INCHES

Electrosurgery

Non-Irrigating Bipolar Forceps

Rose Gold Reverse Action Bipolar Forceps

Catalog Number	Tip Size (mm)	Shape	Insulation	Irrigation	Working Length (in.)	Length (in.)
US547	0.7	BAYONET	INS	NON-IRRG	6	10
US548	1.0	BAYONET	INS	NON-IRRG	6	10



Rose Gold Minimally Invasive (MIS) Forceps

Catalog Number	Tip	Tip Size (mm)	Shape	Insulation	Irrigation	Working Length (in.)	Length (in.)
US541	STR	0.7	BAYONET	INS	NON-IRRG	5 1/4	9 1/2
US542	STR	1.2	BAYONET	INS	NON-IRRG	5 1/4	9 1/2
US543	STR	0.7	BAYONET	INS	NON-IRRG	6 1/4	10 1/2
US544	STR	1.2	BAYONET	INS	NON-IRRG	6 1/4	10 1/2
US545	45° UP	0.7	BAYONET	INS	NON-IRRG	5 1/4	9 1/2
US546	45° UP	0.7	BAYONET	INS	NON-IRRG	6 1/4	10 1/2

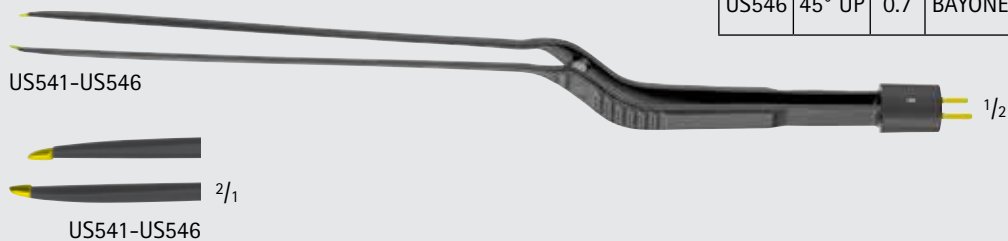

Rose Gold SEMKIN Bipolar Forceps

Catalog Number	Tip Size (mm)	Shape	Insulation	Irrigation	Length (in.)
US413	1.5	STR	INS	NON-IRRG	6



Electrosurgery

Non-Irrigating Bipolar Forceps

SCOVILLE Bipolar Forceps, Stainless Steel

Catalog Number	Tip Size (mm)	Shape	Insulation	Irrigation	Working Length (in.)	Length (in.)
US534	1.0	BAYONET	INS	NON-IRRG	2 3/4	7 3/4
US301	1.5	BAYONET	INS	NON-IRRG	2 3/4	7 3/4
US300	1.5	BAYONET	NON-INS	NON-IRRG	2 3/4	7 3/4



GERALD Bipolar Forceps, Stainless Steel

Catalog Number	Tip Size (mm)	Shape	Insulation	Irrigation	Working Length (in.)	Length (in.)
US342	1.0	BAYONET	INS	NON-IRRG	3 1/2	7 1/2
US307	1.0	BAYONET	NON-INS	NON-IRRG	3 1/2	7 1/2

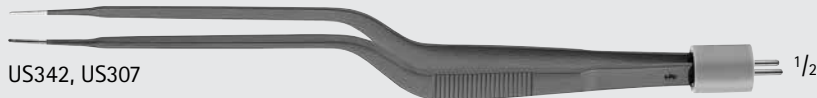

CUSHING Bipolar Forceps, Stainless Steel

Catalog Number	Tip Size (mm)	Shape	Insulation	Irrigation	Working Length (in.)	Length (in.)
US308	0.7	BAYONET	INS	NON-IRRG	3 1/2	7 1/2
US182	1.0	BAYONET	INS	NON-IRRG	3 1/2	7 1/2
US183	1.5	BAYONET	INS	NON-IRRG	3 1/2	7 1/2
US305	2.0	BAYONET	INS	NON-IRRG	3 1/2	7 1/2

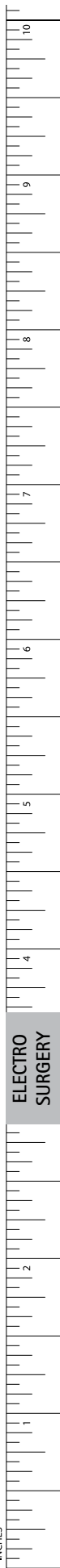
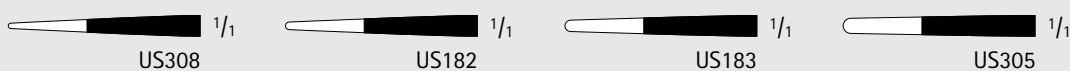
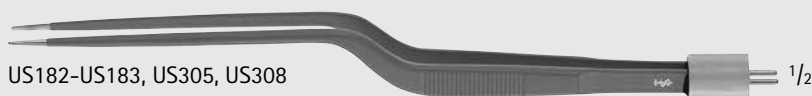

ELECTRO SURGERY

INCHES

Electrosurgery

Non-Irrigating Bipolar Forceps

HARDY Bipolar Forceps, Stainless Steel

Catalog Number	Tip Size (mm)	Shape	Insulation	Irrigation	Working Length (in.)	Length (in.)
US310	0.5	BAYONET	INS	NON-IRRIG	4 1/2	8 1/2
US536	0.7	BAYONET	INS	NON-IRRIG	4 1/2	8 1/2
US184	1.0	BAYONET	INS	NON-IRRIG	4 1/2	8 1/2
US185	1.5	BAYONET	INS	NON-IRRIG	4 1/2	8 1/2
US186	2.0	BAYONET	INS	NON-IRRIG	4 1/2	8 1/2
US187	0.5	BAYONET	INS	NON-IRRIG	6	10
US188	1.0	BAYONET	INS	NON-IRRIG	6	10
US189	1.5	BAYONET	INS	NON-IRRIG	6	10

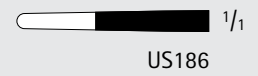
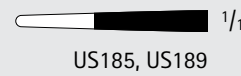
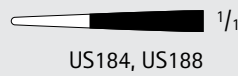
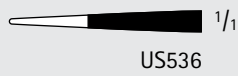
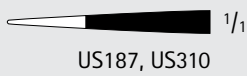

HARDY Bipolar Forceps, Stainless Steel

Catalog Number	Tip Size (mm)	Shape	Insulation	Irrigation	Working Length (in.)	Length (in.)
US309	0.5	BAYONET	NON-INS	NON-IRRIG	4 1/2	8 1/2



ELECTRO SURGERY

Electrosurgery

Non-Irrigating Bipolar Forceps

BARRÉ BipoJET® Nerve/Tissue Sparing Bipolar Forceps, Stainless Steel

Catalog Number	Tip Size (mm)	Shape	Insulation	Irrigation	Length (in.)
GK685R	3.0	BAYONET	INS	NON-IRRG	10 1/4



Strong Tension Bipolar Forceps, Stainless Steel

Catalog Number	Tip Size (mm)	Shape	Insulation	Irrigation	Working Length (in.)	Length (in.)
US314	0.5	BAYONET	NON-INS	NON-IRRG	2 3/8	6 1/4
US315	0.7	BAYONET	NON-INS	NON-IRRG	2 3/8	6 1/4
US316	1.0	BAYONET	NON-INS	NON-IRRG	2 3/8	6 1/4
US317	1.3	BAYONET	NON-INS	NON-IRRG	2 3/8	6 1/4
US318	0.5	BAYONET	NON-INS	NON-IRRG	3 1/4	7 1/8
US319	0.7	BAYONET	NON-INS	NON-IRRG	3 1/4	7 1/8
US320	1.0	BAYONET	NON-INS	NON-IRRG	3 1/4	7 1/8
US321	1.3	BAYONET	NON-INS	NON-IRRG	3 1/4	7 1/8
US322	0.5	BAYONET	NON-INS	NON-IRRG	4	7 7/8
US323	0.7	BAYONET	NON-INS	NON-IRRG	4	7 7/8
US324	1.0	BAYONET	NON-INS	NON-IRRG	4	7 7/8
US325	1.3	BAYONET	NON-INS	NON-IRRG	4	7 7/8



ELECTRO SURGERY

INCHES

Electrosurgery

Non-Irrigating Bipolar Forceps

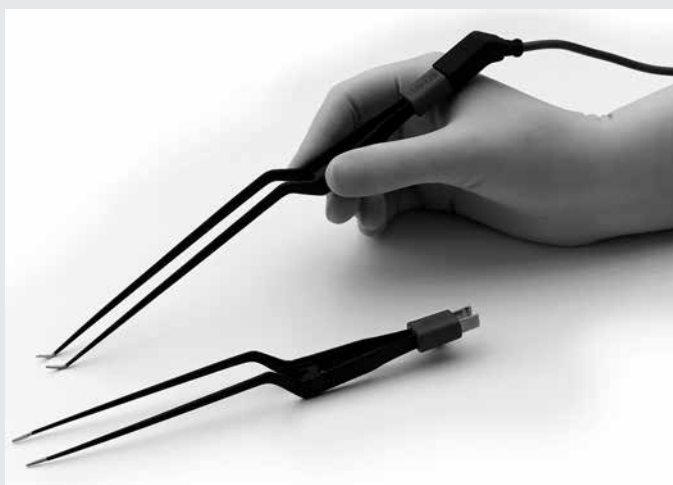

CASPAR Style Bipolar Forceps:

- Developed for precision neurosurgery with a special focus on spine surgery.
- Parallel guiding handle for exact tip alignment.

CASPAR Style Bipolar Forceps, Stainless Steel

Catalog Number	Tip Size (mm)	Shape	Insulation	Irrigation	Working Length (in.)	Length (in.)
GK899R	0.2	BAYONET	INS	NON-IRRG	2 3/4	6 1/2
GK900R	0.5	BAYONET	INS	NON-IRRG	2 3/4	6 1/2
GK910R	1.0	BAYONET	INS	NON-IRRG	2 3/4	6 1/2
GK920R	2.0	BAYONET	INS	NON-IRRG	2 3/4	6 1/2
GK929R	0.2	BAYONET	INS	NON-IRRG	4	7 3/4
GK930R	0.5	BAYONET	INS	NON-IRRG	4	7 3/4
GK940R	1.0	BAYONET	INS	NON-IRRG	4	7 3/4
GK950R	2.0	BAYONET	INS	NON-IRRG	4	7 3/4
GK959R	0.2	BAYONET	INS	NON-IRRG	5	8 3/4
GK960R	0.5	BAYONET	INS	NON-IRRG	5	8 3/4
GK970R	1.0	BAYONET	INS	NON-IRRG	5	8 3/4
GK980R	2.0	BAYONET	INS	NON-IRRG	5	8 3/4

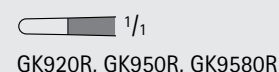
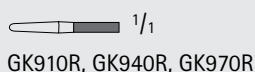
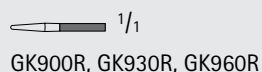
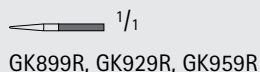

Electrosurgery

Non-Irrigating Bipolar Forceps

CASPAR Style Bipolar Forceps, Stainless Steel

Catalog Number	Tip	Shape	Tip Size (mm)	Insulation	Irrigation	Working Length (in.)	Length (in.)
GK976R	90° UP	BAYONET	1.0	INS	NON-IRRIG	4 3/4	8 1/2
GK978R	90° DOWN	BAYONET	1.0	INS	NON-IRRIG	4 3/4	8 1/2
GK972R	45° UP	BAYONET	1.0	INS	NON-IRRIG	5	8 3/4
GK974R	45° DOWN	BAYONET	1.0	INS	NON-IRRIG	5	8 3/4

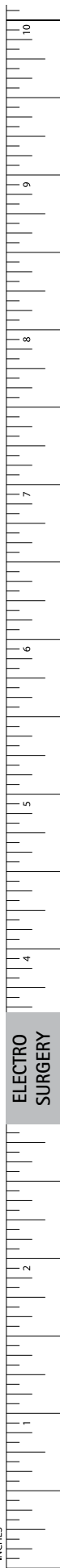
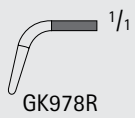
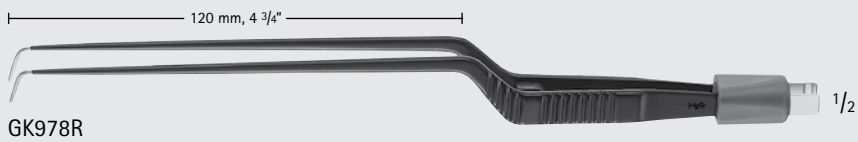
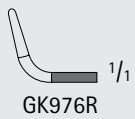
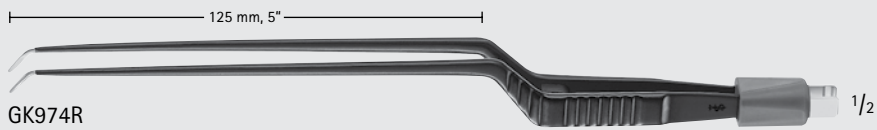
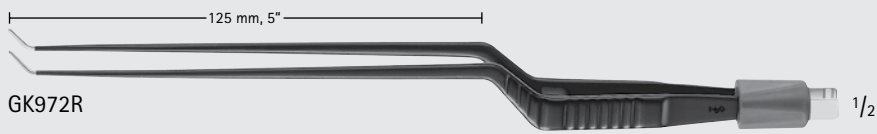

ELECTRO SURGERY

INCHES

Electrosurgery

Non-Irrigating Bipolar Forceps

SINTRAM Bipolar Forceps

Catalog Number	Tip	Tip Size (mm)	Shape	Insulation	Irrigation	Working Length (in.)	Length (in.)
GK644R	STR	0.7 x 6	BAYONET	INS	NON-IRRG	2 3/8	6 1/4
GK645R	STR	1.0 x 6	BAYONET	INS	NON-IRRG	3 1/4	7 1/4
GK646R	STR	1.0 x 6	BAYONET	INS	NON-IRRG	4	7 7/8
GK614R	STR	0.7 x 23	BAYONET	INS	NON-IRRG	2 3/8	6 1/4
GK615R	STR	1.0 x 23	BAYONET	INS	NON-IRRG	3 1/4	7 1/4
GK616R	STR	1.0 x 23	BAYONET	INS	NON-IRRG	4	7 7/8
GK604R	STR	0.9 x 23	STR	INS	NON-IRRG	-	6 1/4
GK605R	STR	0.9 x 23	STR	INS	NON-IRRG	-	7 1/4
GK606R	STR	0.9 x 23	STR	INS	NON-IRRG	-	7 7/8
GK624R	ANG 35°	0.9 x 23	STR	INS	NON-IRRG	-	6 1/4
GK625R	ANG 35°	0.9 x 23	STR	INS	NON-IRRG	-	7 7/8

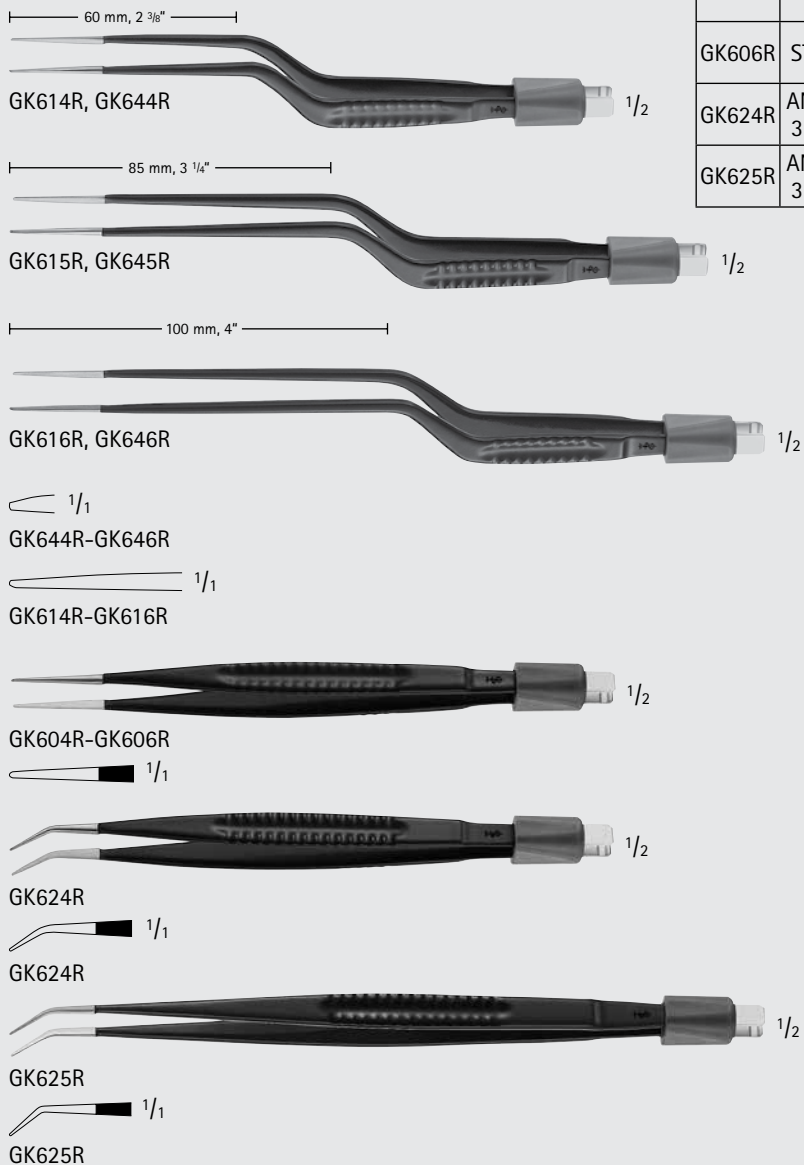

Electrosurgery

Non-Irrigating Bipolar Forceps

MALIS Style Titanium Bipolar Forceps

Catalog Number	Tip	Tip Size (mm)	Shape	Insulation	Irrigation	Working Length (in.)	Length (in.)
US331	STR	0.5	BAYONET	NON-INS	NON-IRRG	3 3/4	8 3/4
US332	STR	1.0	BAYONET	NON-INS	NON-IRRG	3 3/4	8 3/4
US330	STR	1.5	BAYONET	NON-INS	NON-IRRG	3 3/4	8 3/4
US333	ANG-UP	0.5	BAYONET	NON-INS	NON-IRRG	3 3/4	8 3/4
US175	ANG-DOWN	0.5	BAYONET	NON-INS	NON-IRRG	3 3/4	8 3/4



US330-US332



US330-US332



US175, US333



US175, US333

MALIS Style Rose Gold Bipolar Forceps

Catalog Number	Tip	Tip Size (mm)	Shape	Insulation	Irrigation	Working Length (in.)	Length (in.)
US161	STR	0.5	BAYONET	INS	NON-IRRG	3 3/4	8 3/4
US162	STR	1.0	BAYONET	INS	NON-IRRG	3 3/4	8 3/4
US163	STR	1.5	BAYONET	INS	NON-IRRG	3 3/4	8 3/4
US164	ANG-UP	0.5	BAYONET	INS	NON-IRRG	3 3/4	8 3/4
US165	ANG-DOWN	0.5	BAYONET	INS	NON-IRRG	3 3/4	8 3/4



US161-US165



US161



US162

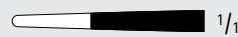

US163



US164



US165



ELECTRO SURGERY

INCHES

Electrosurgery

Non-Irrigating Bipolar Forceps

Titanium Bipolar Forceps

Catalog Number	Tip	Tip Size (mm)	Shape	Insulation	Irrigation	Length (in.)
US326	STR	0.5	STR	NON-INS	NON-IRRG	6
US328	STR	0.5	STR	NON-INS	NON-IRRG	7 1/8
US327	CVD	0.5	STR	NON-INS	NON-IRRG	6
US329	CVD	0.5	STR	NON-INS	NON-IRRG	7 1/8



US326, US328



US327, US329

Micro Bipolar Forceps, Stainless Steel

Catalog Number	Tip	Tip Size (mm)	Shape	Irrigation	Insulation	Length (in.)
US345	STR	0.7	STR	NON-INS	NON-IRRG	6
US347	STR	0.7	STR	NON-INS	NON-IRRG	7 1/8
US346	CVD	0.7	STR	NON-INS	NON-IRRG	6
US348	CVD	0.7	STR	NON-INS	NON-IRRG	7 1/8



US345, US347



US346, US348

Classic Bipolar Forceps, Stainless Steel

Catalog Number	Tip	Tip Size (mm)	Shape	Insulation	Irrigation	Length (in.)
GK700R	STR	0.6	STR	INS	NON-IRRG	6 1/4
GK701R	STR	0.9	STR	INS	NON-IRRG	6 1/4
GK703R	STR	0.9	STR	INS	NON-IRRG	7 7/8
GK711R	ANG-DOWN	0.9	STR	INS	NON-IRRG	6 1/4
GK713R	ANG-DOWN	0.9	STR	INS	NON-IRRG	7 7/8



GK700R-GK703R



GK700R, GK701R, GK703R



GK711R-GK713R



GK711R, GK713R

Electrosurgery

Non-Irrigating Bipolar Forceps

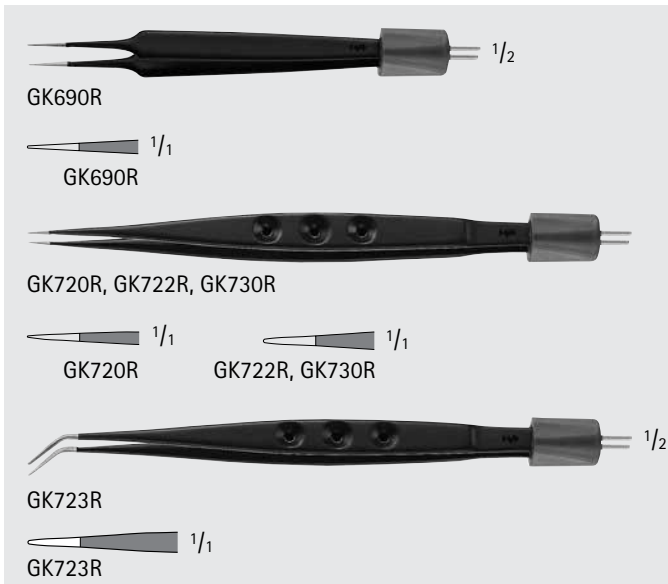

Classic Bipolar Forceps, Stainless Steel

Catalog Number	Tip	Tip Size (mm)	Shape	Insulation	Irrigation	Length (in.)
GK690R	STR	0.4	STR	INS	NON-IRRG	4 3/4
GK720R	STR	0.6	STR	INS	NON-IRRG	6 1/4
GK722R	STR	0.9	STR	INS	NON-IRRG	6 1/4
GK730R	STR	0.9	STR	INS	NON-IRRG	7 7/8
GK723R	ANG-DOWN	0.9	STR	INS	NON-IRRG	6 1/4

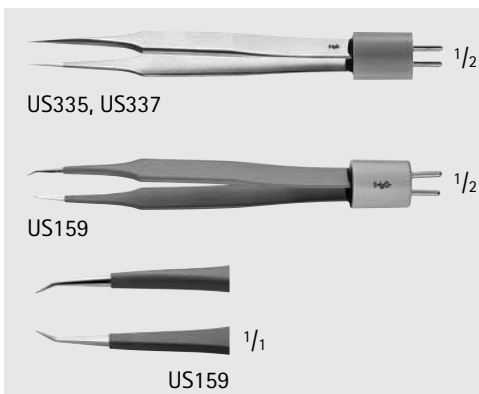

Jewelers Bipolar Forceps, Stainless Steel

Catalog Number	Tip	Tip Size (mm)	Shape	Insulation	Irrigation	Length (in.)
US337	STR	0.4	STR	INS	NON-IRRG	4
US335	STR	0.4	STR	NON-INS	NON-IRRG	4
US159	CVD	0.4	STR	INS	NON-IRRG	4
US336	CVD	0.4	STR	NON-INS	NON-IRRG	4



TENZEL Bipolar Forceps, Stainless Steel

Catalog Number	Tip	Tip Size (mm)	Shape	Insulation	Irrigation	Length (in.)
US178	CVD	0.4	STR	INS	NON-IRRG	4
US338	CVD	0.4	STR	NON-INS	NON-IRRG	4

ELECTRO SURGERY

INCHES

Electrosurgery

Non-Irrigating Bipolar Forceps

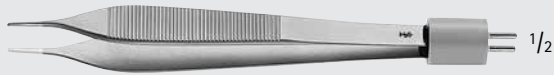

US339-US340

ADSON Bipolar Forceps, Stainless Steel

Catalog Number	Tip	Tip Size (mm)	Shape	Insulation	Irrigation	Length (in.)
US340	STR	1.0	STR	INS	NON-IRRG	5
US339	STR	1.0	STR	NON-INS	NON-IRRG	5

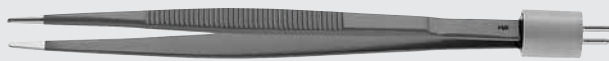

US179-US344

SEMKIN Bipolar Forceps, Stainless Steel

Catalog Number	Tip Size (mm)	Shape	Insulation	Irrigation	Length (in.)
US179	0.7	STR	INS	NON-IRRG	5 1/2
US311	0.7	STR	NON-INS	NON-IRRG	5 1/2
US344	2.0	STR	INS	NON-IRRG	6
US196	2.0	STR	NON-INS	NON-IRRG	6



US197-US304

CUSHING Bipolar Forceps, Stainless Steel

Catalog Number	Tip Size (mm)	Shape	Insulation	Irrigation	Length (in.)
US197	0.7	STR	INS	NON-IRRG	6
US302	0.7	STR	NON-INS	NON-IRRG	6
US304	1.5	STR	INS	NON-IRRG	7
US303	1.5	STR	NON-INS	NON-IRRG	7

Electrosurgery

Non-Irrigating Bipolar Forceps

GERALD Bipolar Forceps, Stainless Steel

Catalog Number	Tip	Shape	Insulation	Irrigation	Length (in.)
US341	STR	STR	INS	NON-IRRIG	7
US306	STR	STR	NON-INS	NON-IRRIG	7



US306-US341

Rose Gold Bipolar Forceps

Catalog Number	Tip Size (mm)	Shape	Style	Insulation	Irrigation	Length (in.)
US171	1.0	STR	ADSON	INS	NON-IRRIG	5
US172	0.4	STR	JEWELERS	INS	NON-IRRIG	4

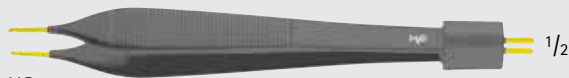

US171

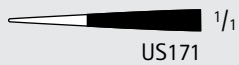

US171



US172



US172

MALIS Style Titanium Bipolar Forceps

Catalog Number	Tip Size (mm)	Shape	Insulation	Irrigation	Length (in.)
US176	0.25	STR	NON-INS	NON-IRRIG	6
US177	0.5	STR	NON-INS	NON-IRRIG	6



US176-US177



US176-US177

Micro and Laboratory Forceps, Stainless Steel

Catalog Number	Tip	Tip Size (mm)	Shape	Insulation	Irrigation	Length (in.)
GK596R	STR	0.3	STR	INS	NON-IRRIG	5 3/4
GK595R	STR	0.6	STR	INS	NON-IRRIG	4 3/4
GK597R	CVD	0.6	STR	INS	NON-IRRIG	4 1/4



GK595R-GK596R

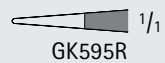

GK595R

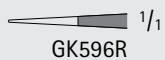

GK596R



GK597R



GK597R

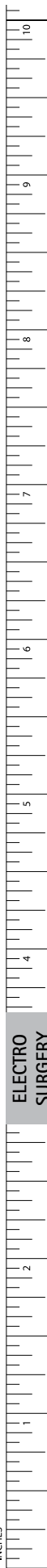

ELECTRO SURGERY

INCHES

Electrosurgery

Non-Irrigating Bipolar Forceps

BiProtect® Ceramic Insulated Tip, Insulated

- Ceramic tip insulation helps ensure that heat concentrates on the inner and distal part of the forceps
 - Less collateral damage and reduced thermal spread
 - Partially insulated tip allows for precise and safe surface coagulation

YASARGIL BiProtect Ceramic Insulated Tip Forceps

Catalog Number	Tip	Tip Size (mm)	Shape	Insulation	Irrigation	Working Length (in.)	Length (in.)
GL470R	STR	0.4	BAYONET	INS	NON-IRRG	3 1/2	7 3/4
GL471R	STR	0.8	BAYONET	INS	NON-IRRG	3 1/2	7 3/4
GL480R	STR	0.4	BAYONET	INS	NON-IRRG	4 1/2	8 1/2
GL481R	STR	0.8	BAYONET	INS	NON-IRRG	4 1/2	8 1/2



GL470R-GL481R



GL470R, GL480R



GL471R, GL481R

Transnasal Bipolar Forceps, Stainless Steel

Catalog Number	Tip Size (mm)	Shape	Insulation	Irrigation	Working Length (in.)	Length (in.)
GK719R	1.0	ANG	INS	NON-IRRG	5 1/8	8 1/2



GK719R



GK719R

130 mm, 5 1/8"

Electrosurgery

Non-Irrigating Bipolar Forceps, Transnasal

MIN Instruments, Pivot-Point Bipolar Forceps, Transnasal

Catalog Number	Tip	Tip Size (mm)	Shape	Working Length (in.)	Length (in.)
GK822R	STR	0.7	BAYONET	3 3/4	8 1/2
GK824R	STR	1.0	BAYONET	3 3/4	8 1/2
GK826R	STR	0.7	BAYONEN	5 1/4	10
GK828R	STR	1.0	BAYONEN	5 1/4	10
GK823R	CVD	0.7	BAYONEN	3 3/4	8 1/2
GK825R	CVD	1.0	BAYONEN	3 3/4	8 1/2
GK827R	CVD	0.7	BAYONEN	5 1/4	10
GK829R	CVD	1.0	BAYONEN	5 1/4	10



Special pin between the branches opens the tip of the forceps by additional compression of the handle, allowing secure coagulation in narrow and deep seated surgical fields.

95 mm, 3 3/4"

GK822R-GK824R



135 mm, 5 1/4"

GK826R-GK828R

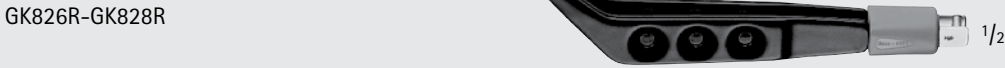

95 mm, 3 3/4"

GK823R-GK825R



135 mm, 5 1/4"

GK827R-GK829R

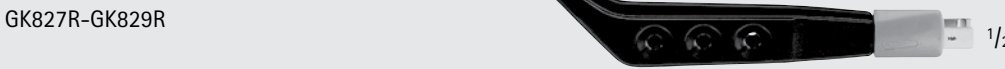

1/1

GK822R, GK823R, GK826R, GK827R

1/1

GK824R, GK825R, GK828R, GK829R



ELECTRO SURGERY

INCHES

Electrosurgery

Non-Irrigating Bipolar Forceps

LANDOLT Bipolar Forceps, Stainless Steel

Catalog Number	Tip	Insulation	Irrigation	Description	Working Length (in.)
GK560R	ANG 90°	INS	NON-IRRIG	COAGULATION FORCEPS F/ HYPOPHYSECTOMY	6
GK561R	90°	-	-	SPARE INNER PART F/ GK560R	
GK580R	ANG 120°	INS	NON-IRRIG	COAGULATION FORCEPS F/ HYPOPHYSECTOMY	6
GK581R	120°	-	-	SPARE INNER PART F/ GK580R	

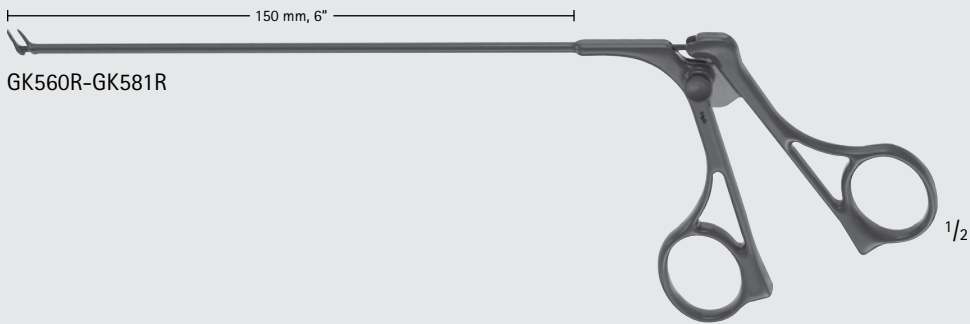

ELECTRO SURGERY

MILLIMETERS

■ Irrigating coagulation forceps facilitate gentle coagulation without tissue adhesion.

Rose Gold Irrigating Bipolar Forceps

Catalog Number	Tip Size (mm)	Shape	Insulation	Irrigation	Working Length (in.)	Length (in.)
US622	0.5	BAYONET	INS	IRRG	3 1/2	7 1/2
US623	0.7	BAYONET	INS	IRRG	3 1/2	7 1/2
US624	1.0	BAYONET	INS	IRRG	3 1/2	7 1/2
US625	1.5	BAYONET	INS	IRRG	3 1/2	7 1/2
US626	2.0	BAYONET	INS	IRRG	3 1/2	7 1/2
US627	0.5	BAYONET	INS	IRRG	3	7 3/4
US628	0.7	BAYONET	INS	IRRG	3	7 3/4
US629	1.0	BAYONET	INS	IRRG	3	7 3/4
US630	1.5	BAYONET	INS	IRRG	3	7 3/4
US631	2.0	BAYONET	INS	IRRG	3	7 3/4
US632	0.5	BAYONET	INS	IRRG	4 1/2	8 1/2
US633	0.7	BAYONET	INS	IRRG	4 1/2	8 1/2
US634	1.0	BAYONET	INS	IRRG	4 1/2	8 1/2
US635	1.5	BAYONET	INS	IRRG	4 1/2	8 1/2
US636	2.0	BAYONET	INS	IRRG	4 1/2	8 1/2
US637	0.5	BAYONET	INS	IRRG	5	9
US638	0.7	BAYONET	INS	IRRG	5	9
US639	1.0	BAYONET	INS	IRRG	5	9
US640	1.5	BAYONET	INS	IRRG	5	9
US641	2.0	BAYONET	INS	IRRG	5	9
US532	0.5	BAYONET	INS	IRRG	6	10
US642	0.7	BAYONET	INS	IRRG	6	10
US643	1.0	BAYONET	INS	IRRG	6	10
US174	1.5	BAYONET	INS	IRRG	6	10
US533	2.0	BAYONET	INS	IRRG	6	10

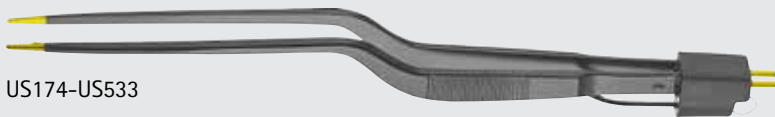

US174-US533

CUSHING Irrigating Bipolar Forceps, Stainless Steel

Catalog Number	Tip Size (mm)	Shape	Insulation	Irrigation	Working Length (in.)	Length (in.)
US369	0.7	BAYONET	INS	IRRG	3 1/2	7 1/2
US190	1.0	BAYONET	INS	IRRG	3 1/2	7 1/2
US191	1.5	BAYONET	INS	IRRG	3 1/2	7 1/2
US370	2.0	BAYONET	INS	IRRG	3 1/2	7 1/2

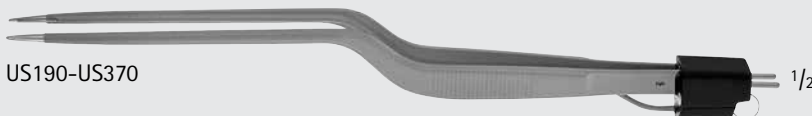

US190-US370



US190-US370



ELECTRO SURGERY

INCHES

Electrosurgery

Irrigating Bipolar Forceps

HARDY Irrigating Bipolar Forceps, Stainless Steel

Catalog Number	Tip Size (mm)	Shape	Insulation	Irrigation	Working Length (in.)	Length (in.)
US366	0.5	BAYONET	INS	IRRG	4 1/2	8 1/2
US382	1.0	BAYONET	INS	IRRG	4 1/2	8 1/2
US385	1.5	BAYONET	INS	IRRG	4 1/2	8 1/2
US192	2.0	BAYONET	INS	IRRG	4 1/2	8 1/2
US193	0.5	BAYONET	INS	IRRG	6	10
US194	1.0	BAYONET	INS	IRRG	6	10
US195	1.5	BAYONET	INS	IRRG	6	10
US558	0.5	BAYONET	NON-INS	IRRG	4 1/2	8 1/2

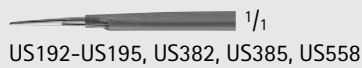

SCOVILLE Irrigating Bipolar Forceps, Stainless Steel

Catalog Number	Tip Size (mm)	Shape	Insulation	Irrigation	Working Length (in.)	Length (in.)
US367	1.5	BAYONET	INS	IRRG	2 3/4	7 3/4
US556	1.5	BAYONET	NON-INS	IRRG	2 3/4	7 3/4

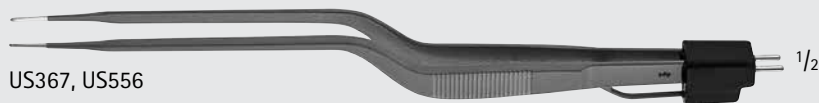

GERALD Irrigating Bipolar Forceps, Stainless Steel

Catalog Number	Tip Size (mm)	Shape	Insulation	Irrigation	Working Length (in.)	Length (in.)
US368	1.0	BAYONET	INS	IRRG	3 1/2	7 1/2
US557	1.0	BAYONET	NON-INS	IRRG	3 1/2	7 1/2

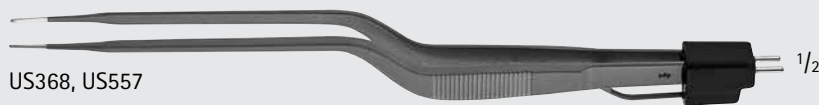

MALIS Style Titanium Irrigating Bipolar Forceps

Catalog Number	Tip	Tip Size (mm)	Shape	Insulation	Irrigation	Working Length (in.)	Length (in.)
US360	STR	1.5	BAYONET	INS	IRRG	3 3/4	8 3/4
US361	STR	0.5	BAYONET	INS	IRRG	3 3/4	8 3/4
US362	STR	1.0	BAYONET	INS	IRRG	3 3/4	8 3/4
US363	ANG-UP	0.5	BAYONET	INS	IRRG	3 3/4	8 3/4
US372	ANG-DOWN	0.5	BAYONET	INS	IRRG	3 3/4	8 3/4



US360-US362



US360-US362



US363, US372



US363, US372

MALIS Style Rose Gold Irrigating Bipolar Forceps

Catalog Number	Tip	Tip Size (mm)	Shape	Insulation	Irrigation	Working Length (in.)	Length (in.)
US166	STR	0.5	BAYONET	INS	IRRG	3 3/4	8 3/4
US167	STR	1.0	BAYONET	INS	IRRG	3 3/4	8 3/4
US168	STR	1.5	BAYONET	INS	IRRG	3 3/4	8 3/4
US169	ANG-UP	0.5	BAYONET	INS	IRRG	3 3/4	8 3/4
US170	ANG-DOWN	0.5	BAYONET	INS	IRRG	3 3/4	8 3/4



US166-US168



US169-US170



Electrosurgery

Irrigating Bipolar Forceps

Irrigating Bipolar Forceps, Stainless Steel

Catalog Number	Tip Size (mm)	Shape	Insulation	Irrigation	Working Length (in.)	Length (in.)
GK838R	0.7	BAYONET	INS	IRRG	2	6 1/2
GK840R	0.4	BAYONET	INS	IRRG	2 3/4	7
GK841R	0.7	BAYONET	INS	IRRG	2 3/4	7
GK842R	1.3	BAYONET	INS	IRRG	2 3/4	7
GK843R	0.4	BAYONET </tr				

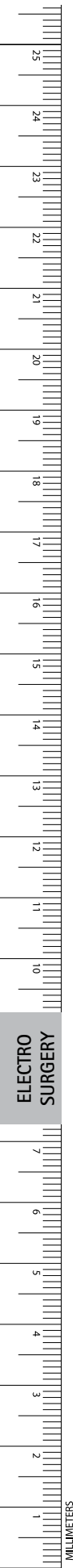
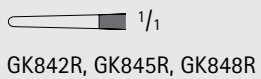
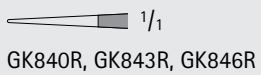
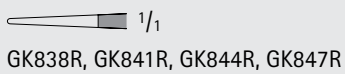
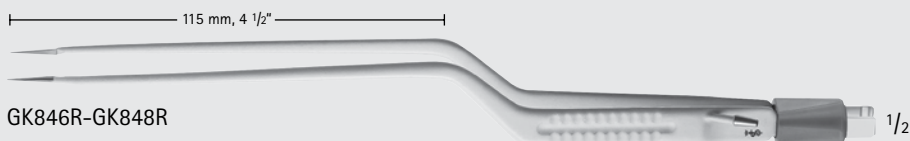
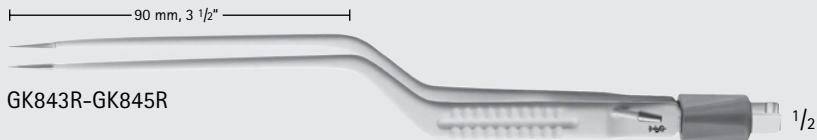
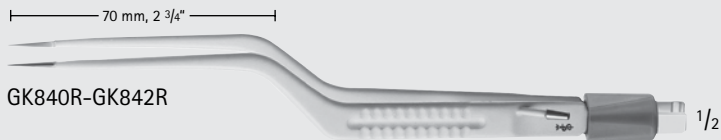

ELECTRO SURGERY

Electrosurgery

Disposable Bipolar Forceps

Stainless Steel Disposable Bipolar Forceps, Box of 10

Catalog Number	Tip Size (mm)	Shape	Style	Insulation	Irrigation	Working Length (in.)	Length (in.)
US153SU	1.5	BAYONET	SCOVILLE	INS	NON-IRRG	2 3/4	7 3/4
US567SU	2.0	BAYONET	CUSHING	INS	NON-IRRG	2 3/4	7 3/4
US562SU	0.7	BAYONET	CUSHING	INS	NON-IRRG	3 1/2	7 1/2
US560SU	1.0	BAYONET	GERALD	INS	NON-IRRG	3 1/2	7 1/2
US154SU	0.5	BAYONET	HARDY	INS	NON-IRRG	4 1/2	8 1/2
US155SU	1.0	BAYONET	HARDY	INS	NON-IRRG	4 1/2	8 1/2
US156SU	1.5	BAYONET	HARDY	INS	NON-IRRG	4 1/2	8 1/2
US157SU	2.0	BAYONET	HARDY	INS	NON-IRRG	4 1/2	8 1/2



US153SU-US567SU



US153SU-US567SU



US158SU



US158SU

ADSON Disposable Bipolar Forceps, Stainless Steel, Box of 10

Catalog Number	Tip Size (mm)	Shape	Insulation	Irrigation	Length (in.)
US158SU	1.0	STR	INS	NON-IRRG	5

Disposable Jewelers Bipolar Forceps, Stainless Steel, Box of 10

Catalog Number	Tip Size (mm)	Shape	Insulation	Irrigation	Length (in.)
US568SU	0.4	STR	NON-INS	NON-IRRG	4
US569SU	0.4	STR	INS	NON-IRRG	4



US568SU-US569SU



ELECTRO SURGERY

INCHES

Electrosurgery

Disposable Bipolar Forceps

Rose Gold Disposable Jewelers Bipolar Forceps, Box of 5

Catalog Number	Tip Size (mm)	Shape	Insulation	Irrigation	Length (in.)
US408SU	0.4	STR	INS	NON-IRRG	4
US409SU	1.0	STR	INS	NON-IRRG	5



US408SU-US409SU

Rose Gold Disposable Bipolar Forceps, Box of 5

Catalog Number	Tip Size (mm)	Shape	Style	Insulation	Irrigation	Working Length (in.)	Length (in.)
US565SU	0.7	STR	SEMKIN	INS	NON-IRRG		5 1/2
US559SU	1.5	BAYONET	SCOVILLE	INS	NON-IRRG	2 3/4	7 3/4
US201SU	0.5	BAYONET	CUSHING	INS	NON-IRRG	3 1/2	7 1/2
US561SU	0.7	BAYONET	CUSHING	INS	NON-IRRG	3 1/2	7 1/2
US202SU	1.0	BAYONET	CUSHING	INS	NON-IRRG	3 1/2	7 1/2
US203SU	1.5	BAYONET	CUSHING	INS	NON-IRRG	3 1/2	7 1/2
US566SU	2.0	BAYONET	CUSHING	INS	NON-IRRG	3 1/2	7 1/2
US204SU	0.5	BAYONET	HARDY	INS	NON-IRRG	4 1/2	8 1/2
US563SU	0.7	BAYONET	HARDY	INS	NON-IRRG	4 1/2	8 1/2
US205SU	1.0	BAYONET	HARDY	INS	NON-IRRG	4 1/2	8 1/2
US206SU	1.5	BAYONET	HARDY	INS	NON-IRRG	4 1/2	8 1/2
US564SU	2.0	BAYONET	HARDY	INS	NON-IRRG	4 1/2	8 1/2



US201SU-US564SU



US565SU

Electrosurgery

Disposable Bipolar Forceps

Rose Gold Disposable Irrigating Bipolar Forceps, Box of 5

Catalog Number	Tip Size (mm)	Shape	Insulation	Irrigation	Working Length (in.)	Length (in.)
US410SU	0.5	BAYONET	INS	IRRG	4 1/2	8 1/2
US411SU	1.0	BAYONET	INS	IRRG	4 1/2	8 1/2
US412SU	1.5	BAYONET	INS	IRRG	4 1/2	8 1/2



Stainless Steel Disposable Irrigating Bipolar Forceps, Box of 5

Catalog Number	Tip Size (mm)	Shape	Insulation	Irrigation	Working Length (in.)	Length (in.)
US523SU	0.5	BAYONET	INS	IRRG	4 1/2	8 1/2
US524SU	1.0	BAYONET	INS	IRRG	4 1/2	8 1/2
US525SU	1.5	BAYONET	INS	IRRG	4 1/2	8 1/2

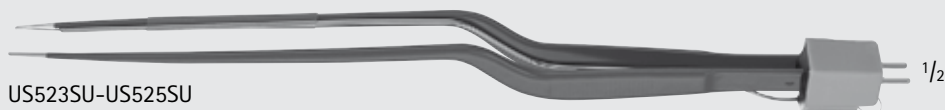

Specialty Disposable Non-Stick Bipolar Forceps

Catalog Number	Tip Size (mm)	Shape	Insulation	Irrigation	Length (in.)
US501SU	0.5	BAYONET	INS	NON-IRRG	7
US502SU	1.0	BAYONET	INS	NON-IRRG	7
US503SU	1.5	BAYONET	INS	NON-IRRG	7
US504SU	0.5	BAYONET	INS	NON-IRRG	8
US505SU	1.0	BAYONET	INS	NON-IRRG	8
US506SU	1.5	BAYONET	INS	NON-IRRG	8
US507SU	0.5	BAYONET	INS	NON-IRRG	9
US508SU	1.0	BAYONET	INS	NON-IRRG	9
US509SU	1.5	BAYONET	INS	NON-IRRG	9



Electrosurgery

Bipolar Connecting Cords

Bipolar Cords for BipoJET®

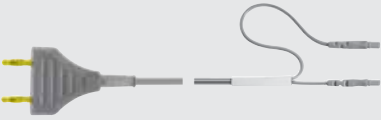
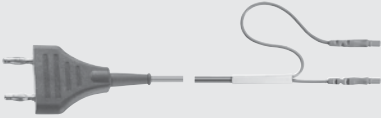
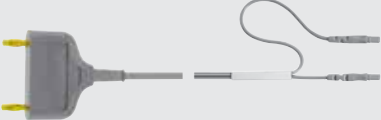
Catalog Number	New Cord	Pin Distance	Compatible Generators
GN145		22 MM	EMC DOLLEX ERBE Int'l MARTIN
GN085		29 MM	AESULAP VALLEYLAB ERBE
GN146		38 MM	CODMAN CMC II / III ERBE MARTIN



GK195

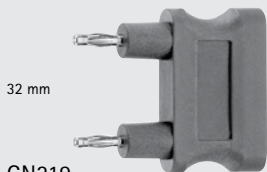

GN219

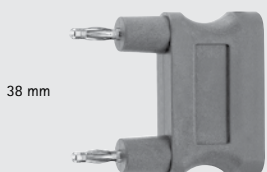

GN224

LANDOLT Bipolar Cord and Adapters

Catalog Number	Pin Distance (mm)	Description
GK195	28.6	REUSABLE CORD F/ INSULATED LANDOLT FORCEPS
GN219	32	ADAPTER F/ CONMED
GN224	38	ADAPTER F/ CODMAN

Electrosurgery

Bipolar Connecting Cords



US349SP

Dual Bipolar Cord, Sterile Disposable

Catalog Number	Packaging	Length (ft)
US349SP	10/BOX	12



US351

Round Bipolar Cord, Reusable

Catalog Number	Material	Length (ft)
US351	SILICONE	12



US359

Dual Bipolar Cord, Reusable

Catalog Number	Length (ft)
US359	12

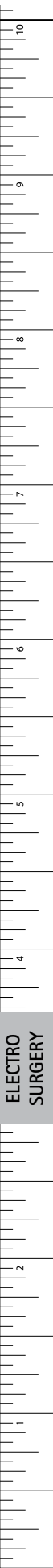

ELECTRO SURGERY

Electrosurgery

Bipolar Connecting Cords

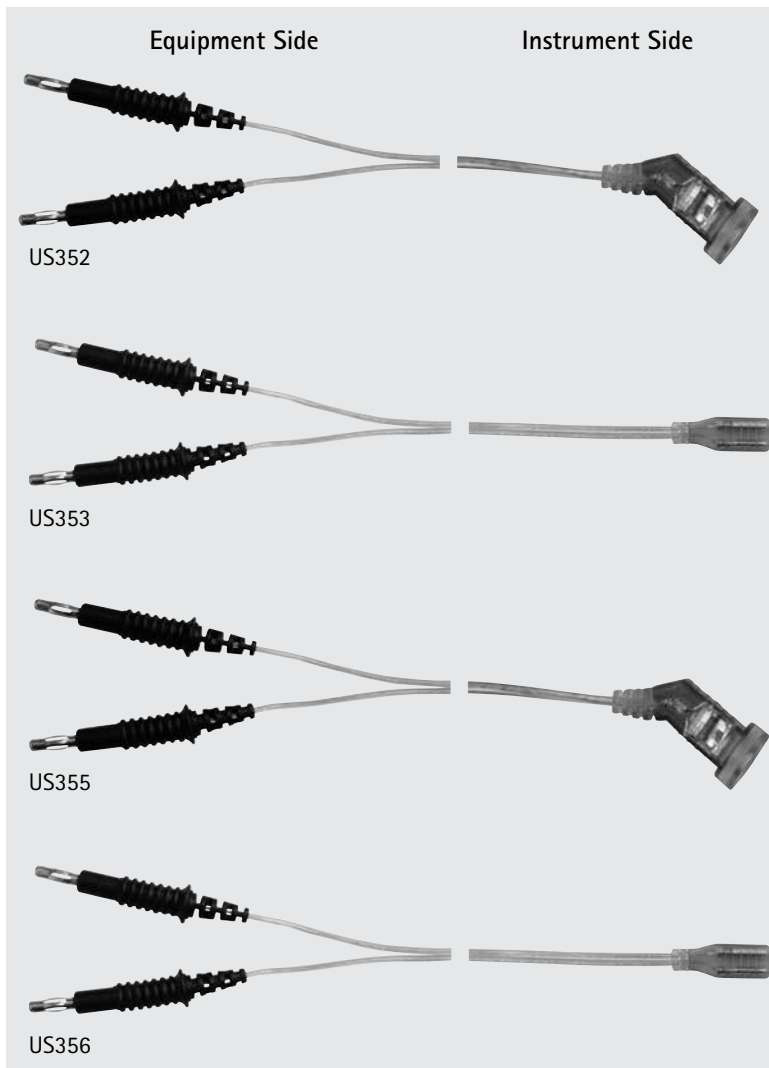

Combined Bipolar and Irrigation Cord

Catalog Number	Pin Type	Packaging	Compatible w/
US352	DUAL	BOX OF 10	-
US353	ROUND	BOX OF 10	-
US355	DUAL	BOX OF 10	MALIS 1000 IRRIGATION SYSTEM
US356	ROUND	BOX OF 10	MALIS 1000 IRRIGATION SYSTEM

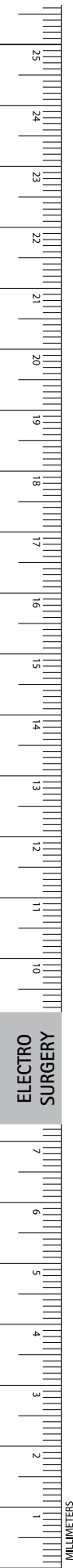

ELECTRO SURGERY



Obstetrics/Gynecology

Scissors	1202 - 1211
Needle Holders	1212
Forceps	1213 - 1250
Clamps	1251 - 1260
Retractors	1261 - 1262
Vaginal Retractors and Specula	1263 - 1281
Endospecula	1282
Dilators and Probes	1283 - 1287
Curettes	1288 - 1294
Accessories	1295

Obstetrics/Gynecology

Scissors

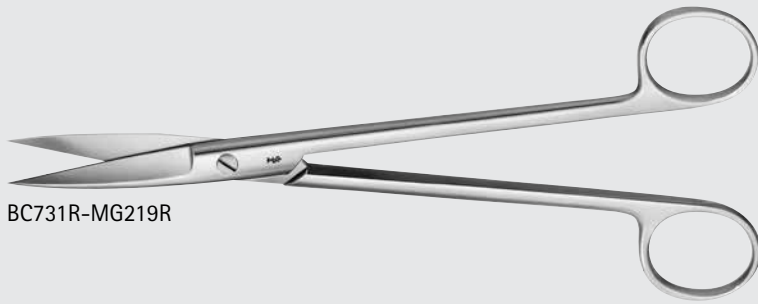

BC731R-MG219R

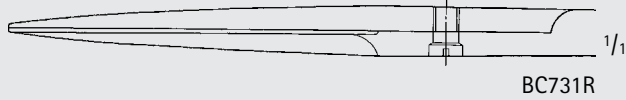

BC731R



MG219R

SIMS Scissors

Catalog Number	Tip	Blade	Length (in.)
BC731R	S/S	STR	7 7/8
MG219R	S/S	CVD	8

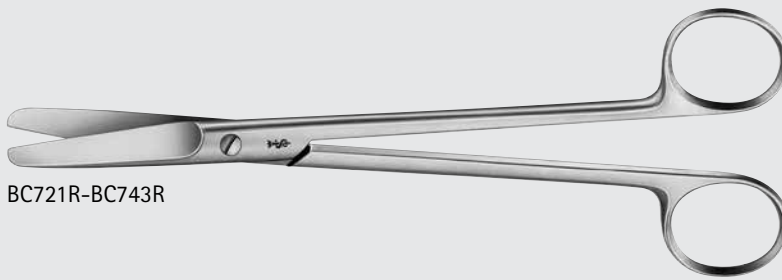

BC721R-BC743R

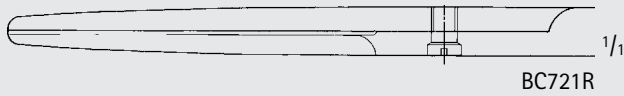

BC721R

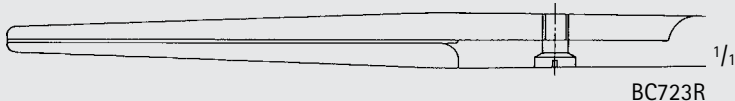

BC723R

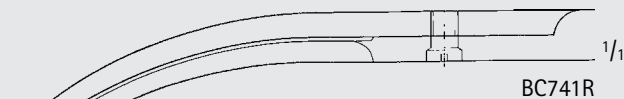

BC741R



BC708R

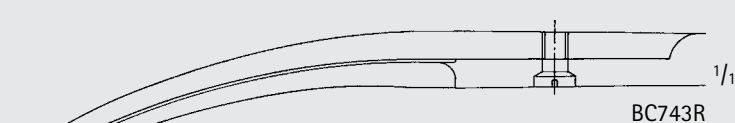

BC743R

SIMS Scissors

Catalog Number	Tip	Blade	Length (in.)
BC721R	B/B	STR	7 7/8
BC723R	B/B	STR	9
BC741R	B/B	CVD	7 7/8
BC708R	B/B	CVD	8 1/4
BC743R	B/B	CVD	9

OB/GYN

SIMS Scissors (continued)

Catalog Number	Tip	Blade	Length (in.)
MG218R	S/B	STR	8
BC746R	S/B	CVD	7 7/8
BC748R	S/B	CVD	9

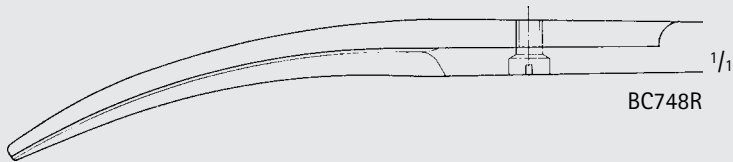
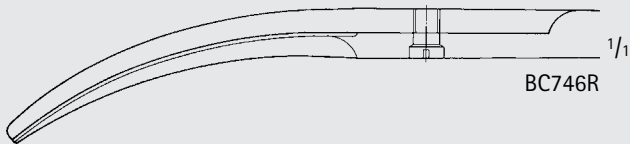
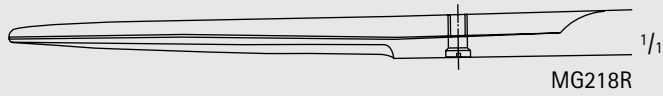
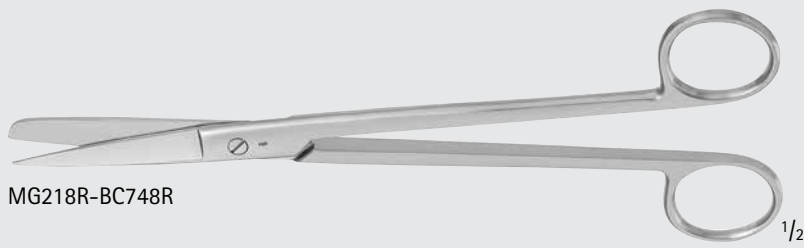

INCHES

Obstetrics/Gynecology

Scissors

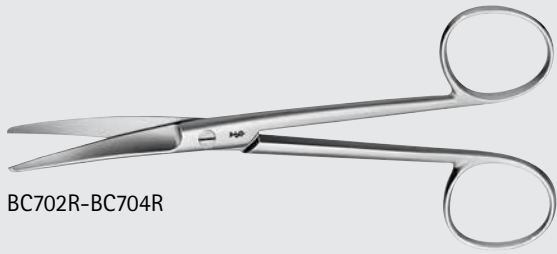

BC702R-BC704R

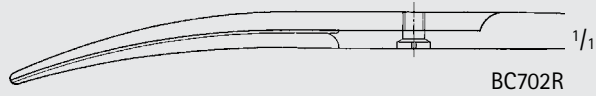

BC702R

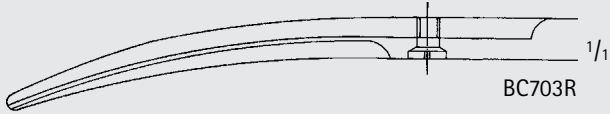

BC703R

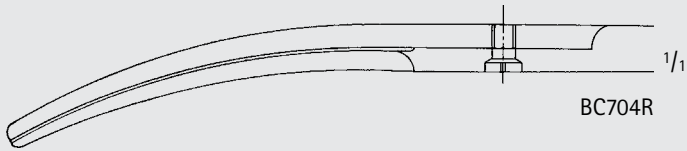

BC704R

WERTHEIM Scissors

Catalog Number	Tip	Blade	Length (in.)
BC702R	B/B	CVD	5 3/4
BC703R	B/B	CVD	7 7/8
BC704R	B/B	CVD	9



OB/GYN

JORGENSEN Scissors

Catalog Number	Tip	Blade	Length (in.)
MD491	B/B	CVD	8 3/4

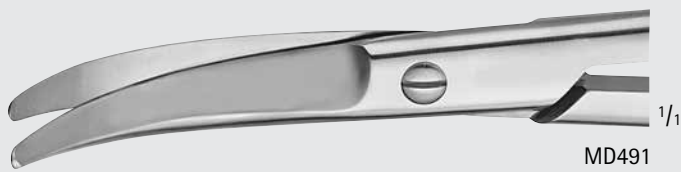
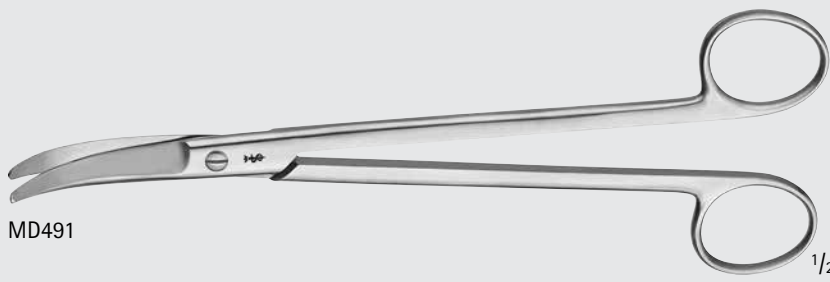

SIEBOLD Uterine Scissors

Catalog Number	Tip	Blade	Length (in.)
BC760R	B/B	CVD	9 5/8

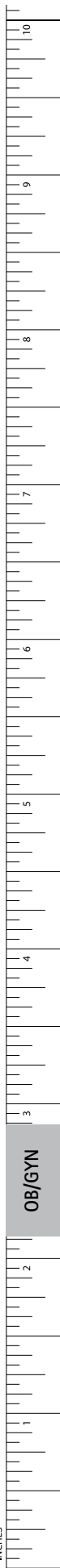
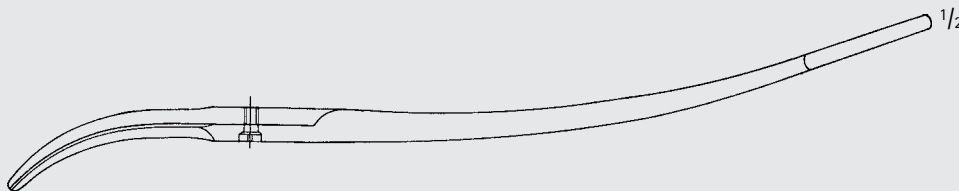
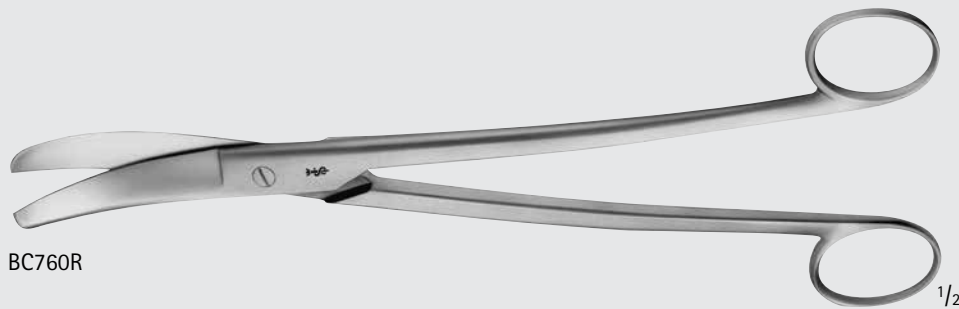

Obstetrics/Gynecology

Scissors

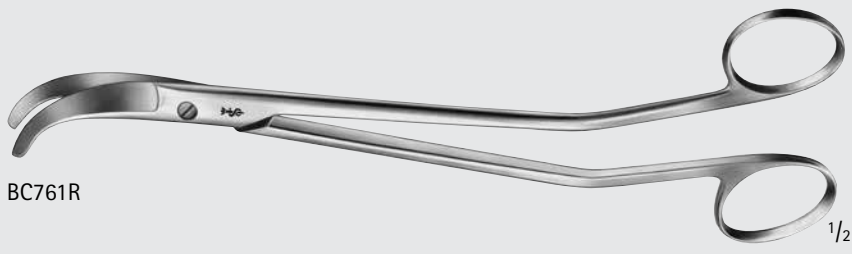
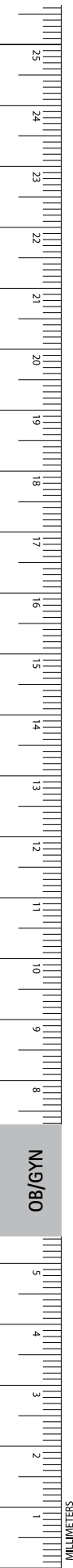

BC761R

1/2

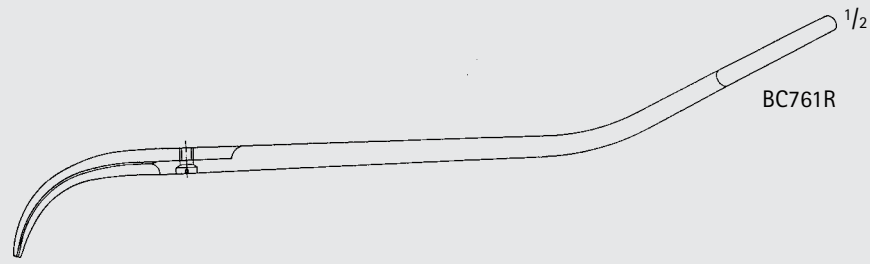

BC761R

1/2

BOZEMANN Uterine Scissors

Catalog Number	Tip	Blade	Length (in.)
BC761R	B/B	CVD	8 3/4

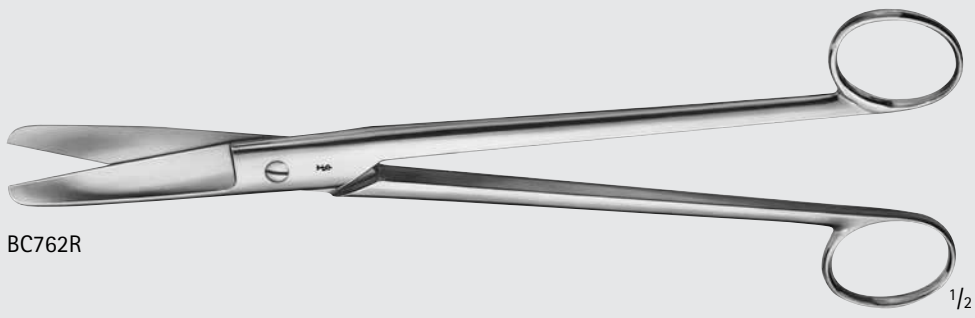

BC762R

1/2

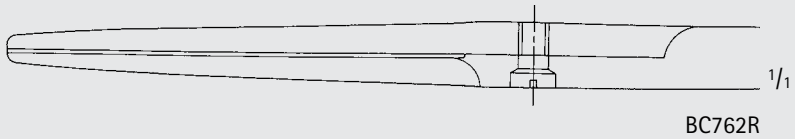

BC762R

1/1

SIMS-SIEBOLD Uterine Scissors

Catalog Number	Tip	Blade	Length (in.)
BC762R	B/B	STR	9 3/4

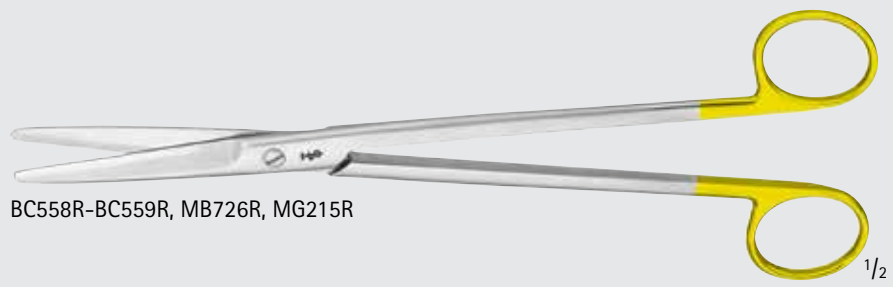

BC558R-BC559R, MB726R, MG215R

DUROTIP TC MAYO Dissecting Scissors

Catalog Number	Tip	Blade	Length (in.)
BC558R	B/B	STR	9
MG215R	B/B	STR	14
BC559R	B/B	CVD	9
MB726R	B/B	CVD	14

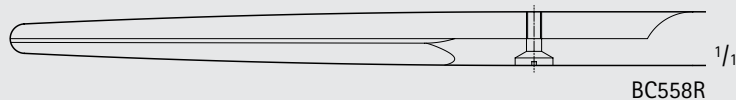

BC558R

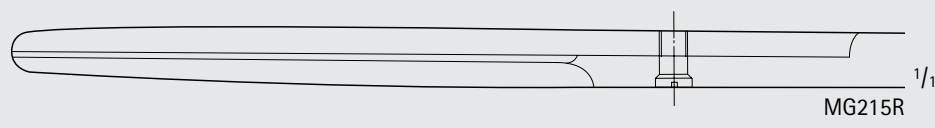

MG215R

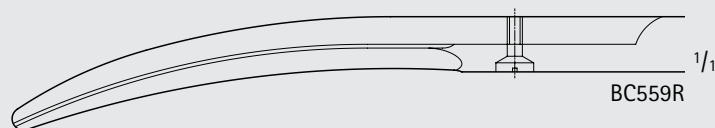

BC559R

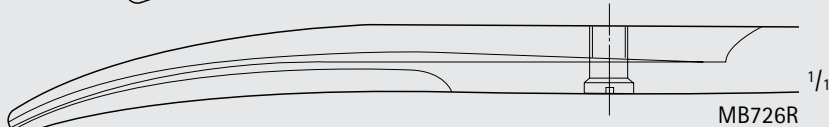

MB726R



BC290R-BC291R

DUROTIP TC SIMS Uterine Scissors

Catalog Number	Tip	Blade	Length (in.)
BC290R	B/B	CVD	7 7/8
BC291R	B/B	CVD	9

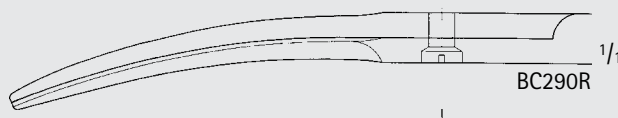

BC290R

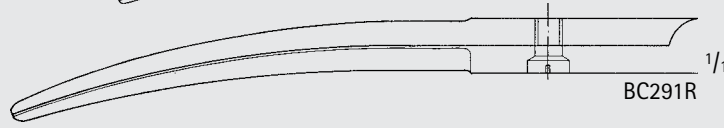

BC291R

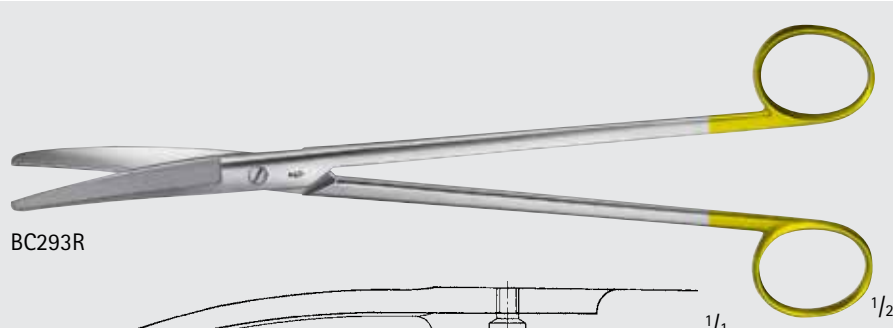

BC293R

DUROTIP TC WERTHEIM Scissors

Catalog Number	Length (in.)
BC293R	9

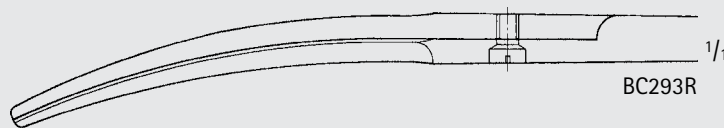

BC293R

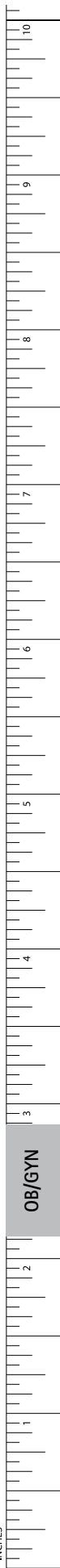

Obstetrics/Gynecology

DUROTIP™ TC Scissors

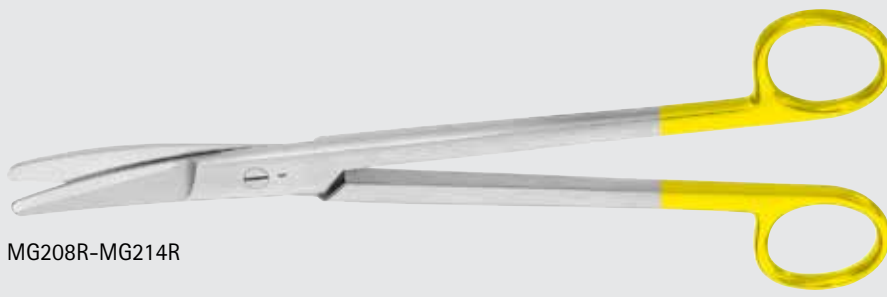

MG208R-MG214R

DUROTIP TC Uterine Scissors

Catalog Number	Tip	Length (in.)
MG208R	SLIGHT CVD	9
MG209R	STRONG CVD	9
MG210R	ANG	9
MG211R	ANG	10 1/2
MG212R	SLIGHT CVD	11 3/4
MG213R	STRONG CVD	11 3/4
MG214R	ANG	11 3/4

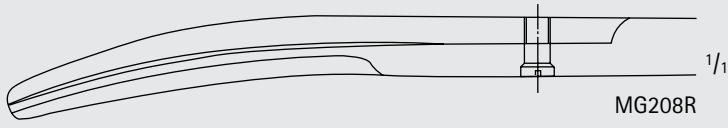

MG208R

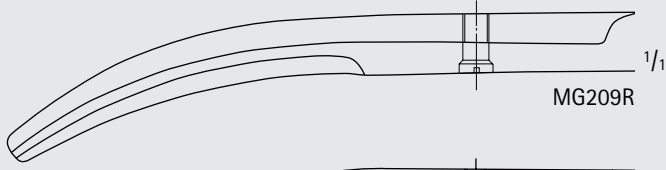

MG209R

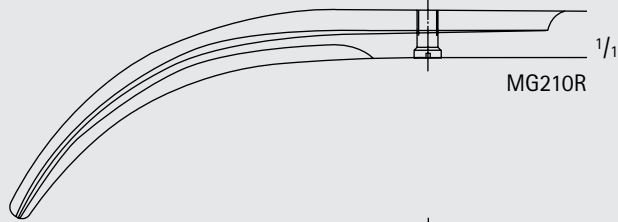

MG210R

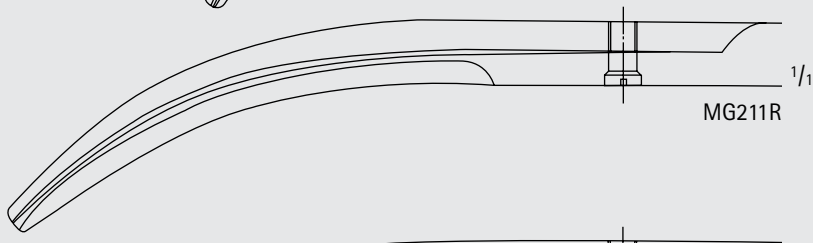

MG211R



MG212R

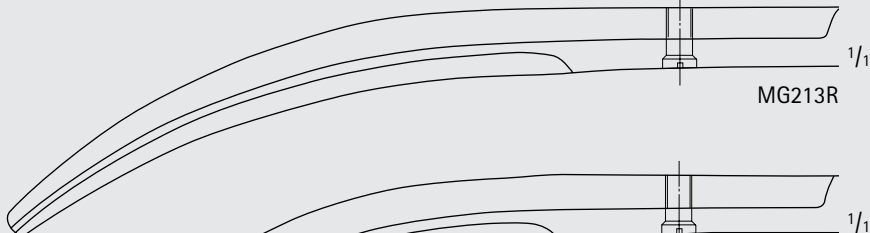

MG213R

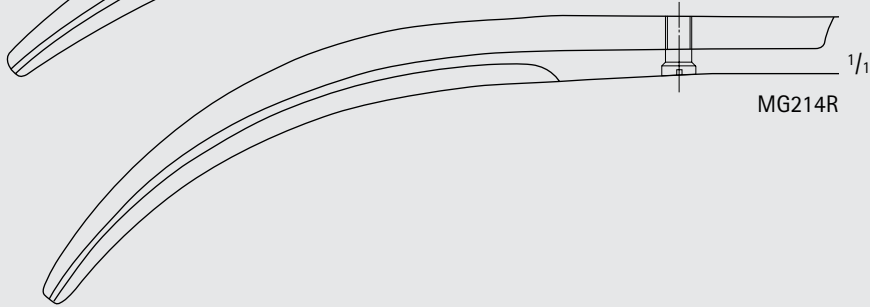

MG214R

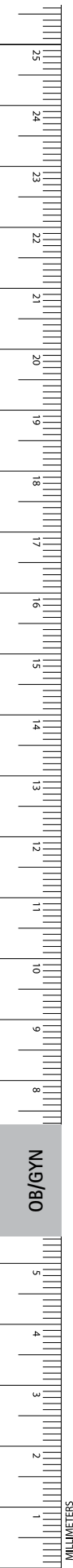



Wavecut

Wavecut scissors have one serrated cutting edge to help prevent tissue from slipping. The W after the item number indicates the scissors are the wavecut style, e.g. BC211W.



BC290W-BC291W

DUROTIP TC SIMS Uterine Wavecut Scissors

Catalog Number	Tip	Blade	Length (in.)
BC290W	B/B	CVD	7 7/8
BC291W	B/B	CVD	9

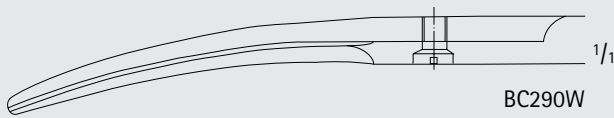

BC290W



BC291W



BC287W

DUROTIP TC METZENBAUM Wavecut Dissecting Scissors, Heavy

Catalog Number	Tip	Blade	Length (in.)
BC287W	B/B	CVD	9

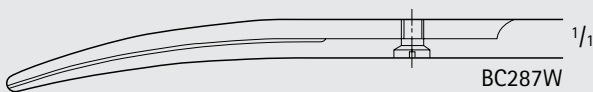

BC287W

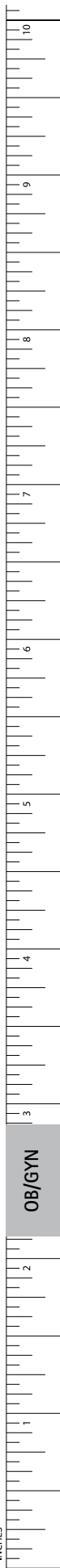

INCHES

OB/GYN

Obstetrics/Gynecology

Scissors



BC796R-BC797R

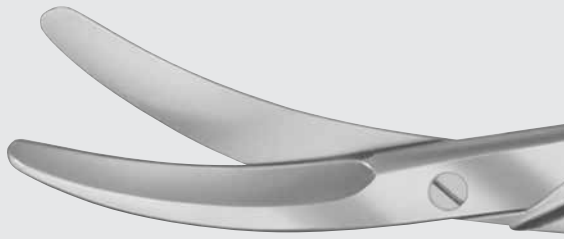

BC796R

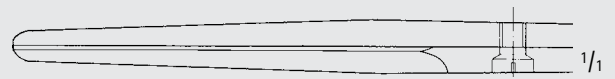

BC797R

Umbilical Cord Scissors

Catalog Number	Tip	Blade	Length (in.)
BC796R	B/B	LAT-CVD	5 1/4
BC797R	B/B	LAT-CVD	6 1/4



ET152R

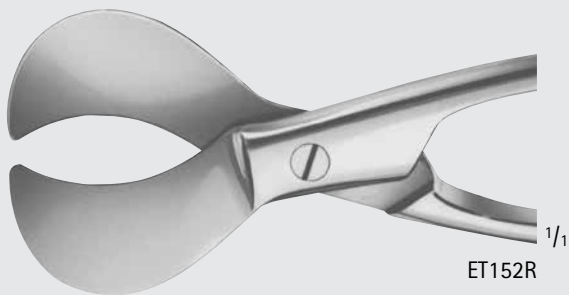

ET152R

Umbilical Cord Scissors

Catalog Number	Length (in.)
ET152R	4 1/8



OB/GYN

SCHUHMACHER Umbilical Cord Scissors

Catalog Number	Length (in.)
ET150R	6 1/8

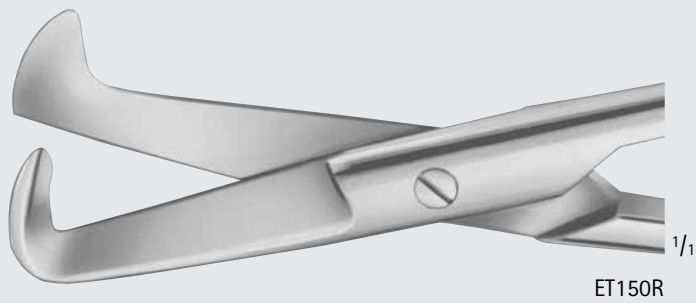
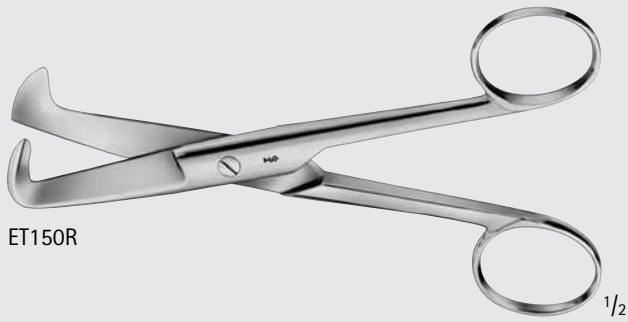

BRAUN-STADLER Episiotomy Scissors

Catalog Number	Blade	Length (in.)
ET140R	SERR	5 3/4
ET141R	SERR	7 7/8

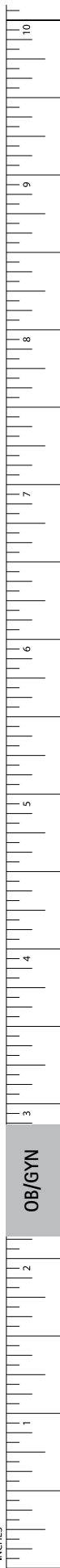
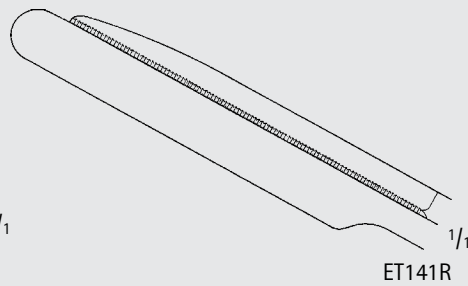
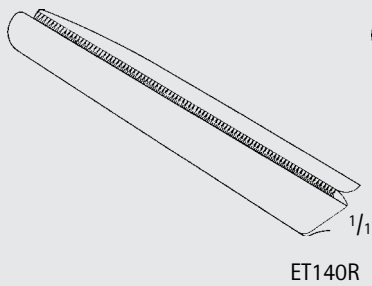

Obstetrics/Gynecology

Needle Holders

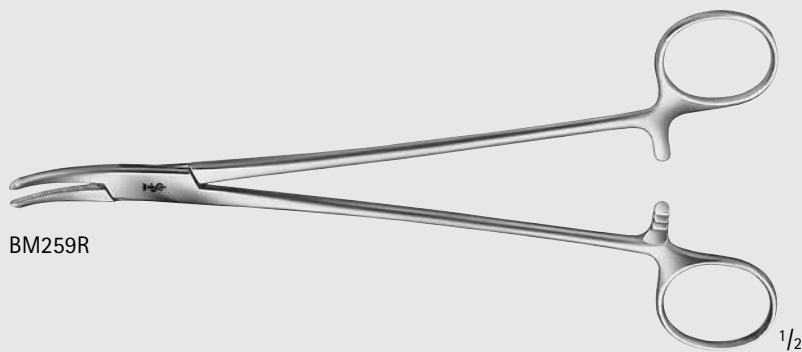

BM259R

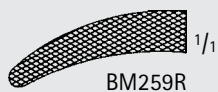

HEANEY Needle Holder

Catalog Number	Tip	Jaw	Length (in.)
BM259R	CVD	SERR	7 7/8

Aesculap features Needle Holders with Tungsten Carbide (TC) inserts. A smooth jaw and three different serration patterns are available, depending on the size of the suture needle.

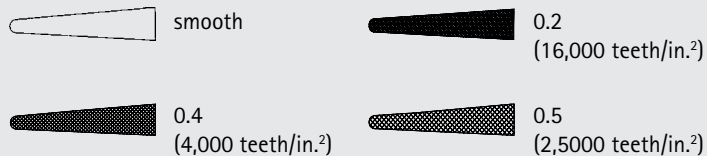
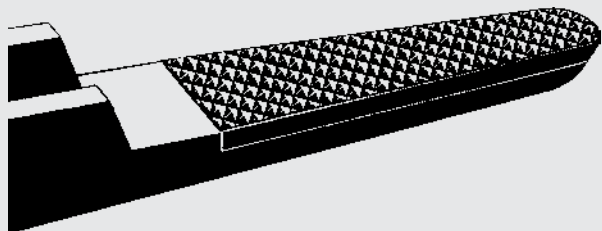

We recommend carbide inserts as follows:

Jaw Surface	Suture Material
Smooth	9/0 - 11/0
0.2 mm pitch of serration	6/0 - 10/0
0.4 mm pitch of serration	4/0 - 6/0
0.5 mm pitch of serration	up to 3/0

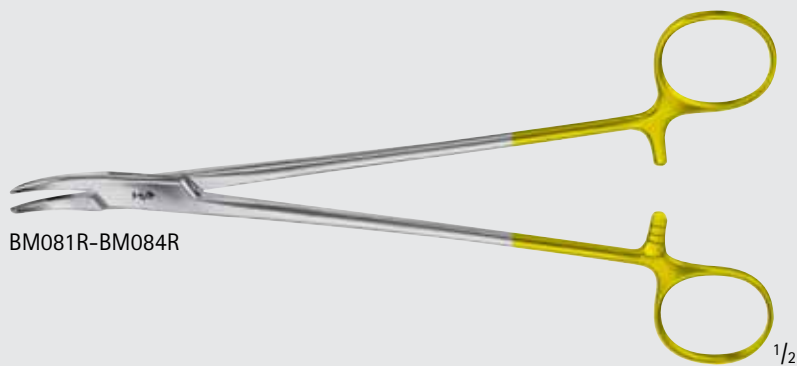

BM081R-BM084R

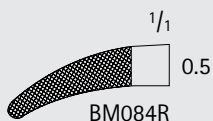
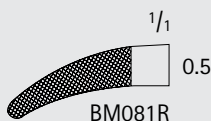

DUROGRIP™ TC HEANEY Needle Holder

Catalog Number	Tip	Jaw	Length (in.)
BM081R	CVD	SERR	7 7/8
BM084R	CVD	SERR	10 1/4

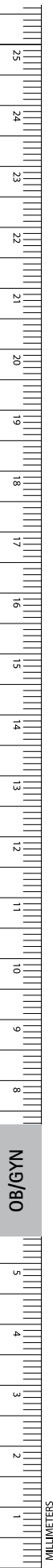

Obstetrics/Gynecology

Tenaculum and Sponge Forceps

MAIER Forceps

Catalog Number	Jaw	Length (in.)
BF056R	STR	10 1/2
BF057R	CVD	10 1/2

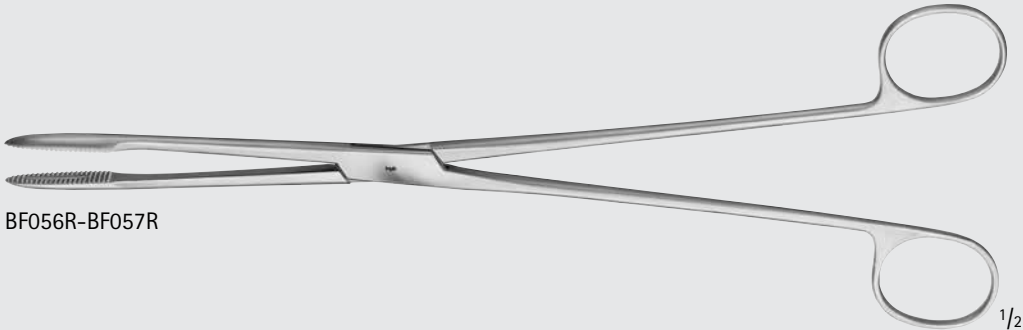

BF056R-BF057R

1/2

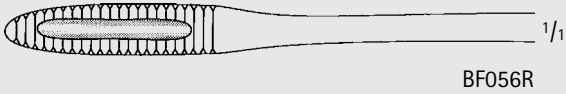

BF056R

1/1

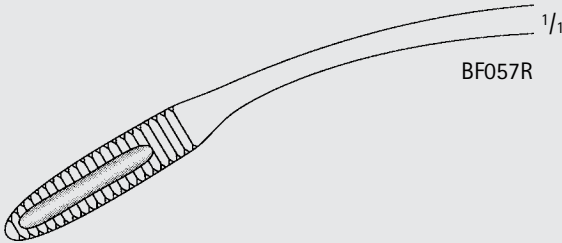

BF057R

1/1

MAIER Forceps, W/ Ratchet

Catalog Number	Jaw	Length (in.)
BF058R	STR	10 1/4
BF059R	CVD	10 1/4

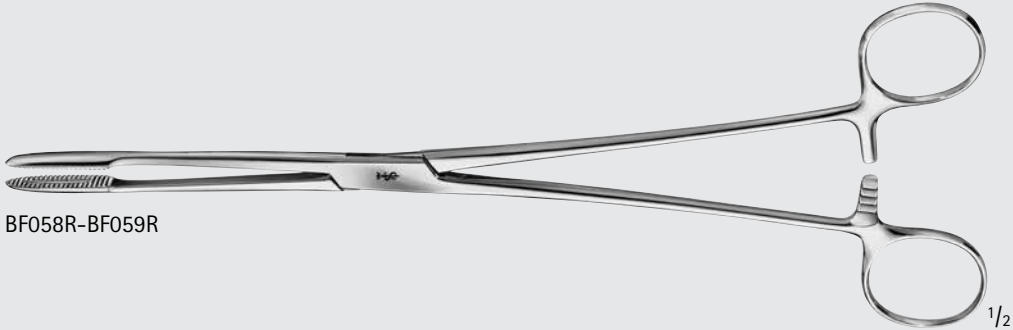

BF058R-BF059R

1/2



BF058R

1/1

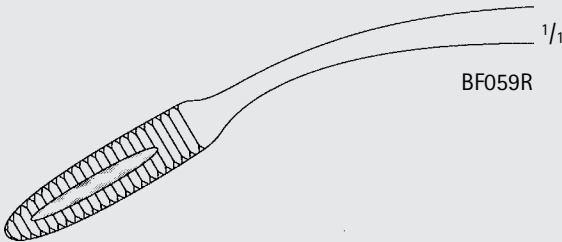

BF059R

1/1



Obstetrics/Gynecology

Tenaculum and Sponge Forceps

SIMS-MAIER Sponge Forceps, W/ Ratchet

Catalog Number	Jaw	Length (in.)
BF076R	STR	11
BF077R	CVD	11

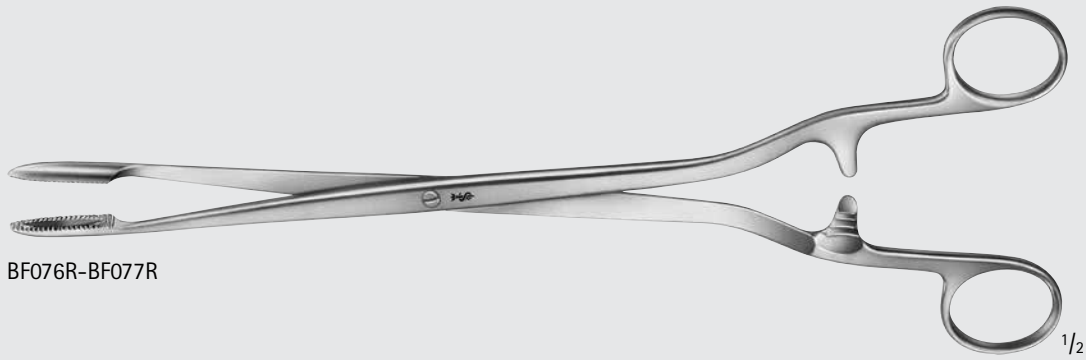

BF076R-BF077R

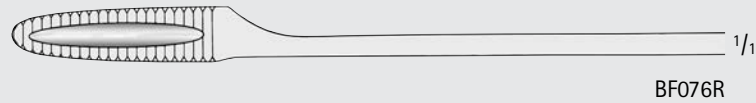

BF076R



BF077R

PELKMANN Forceps

Catalog Number	Tip	Jaw	Length (in.)
EO060R	SERR	STR	10 1/4
EO061R	SERR	CVD	10 1/4

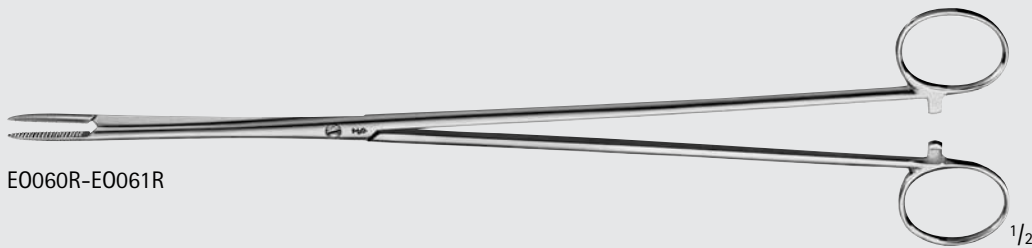

EO060R-EO061R

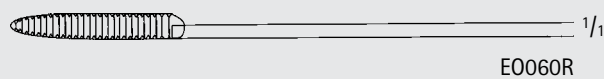

EO060R



EO061R

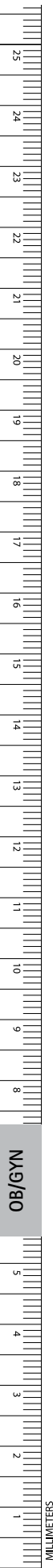

Obstetrics/Gynecology

Tenaculum and Sponge Forceps

BOZEMANN Forceps

Catalog Number	Shaft	Jaw	Length (in.)
E0080R	STR	SERR	10 1/4
E0075R	S-CVD	SMOOTH	9 3/4
E0082R	S-CVD	SERR	9 3/4
E0077R	S-CVD	W/ GROOVE	10

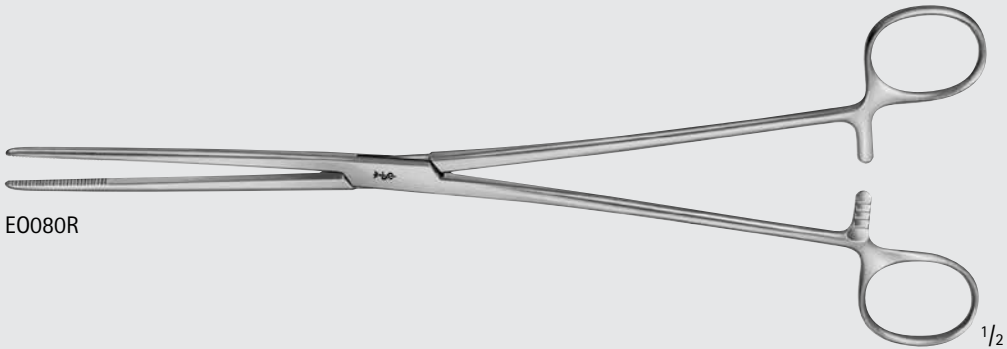

E0080R

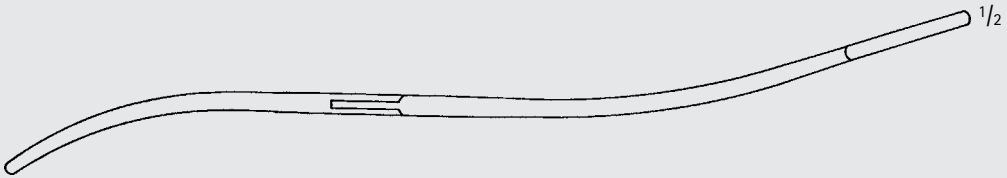

E0080R

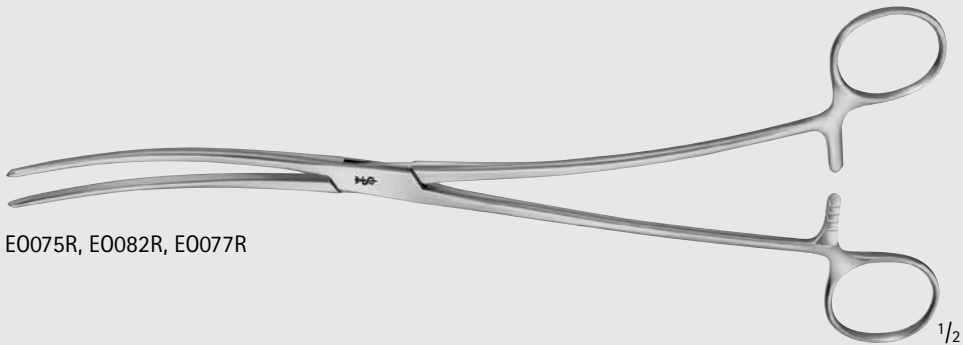

E0075R, E0082R, E0077R

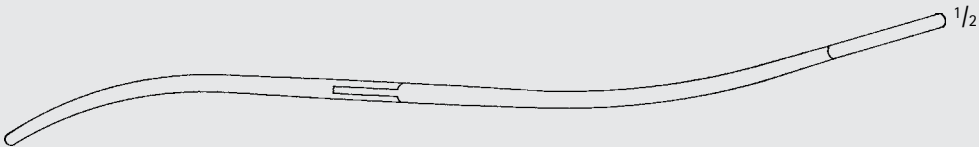

E0075R, E0082R, E0077R

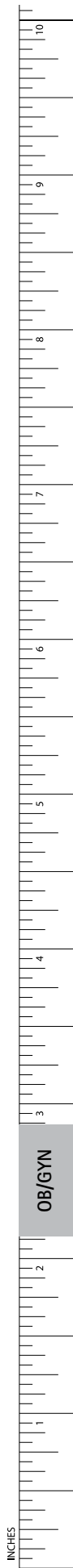

Obstetrics/Gynecology

Tenaculum and Sponge Forceps

BOZEMANN-DOUGLAS Forceps

Catalog Number	Tip	Length (in.)
EO085R	SERR	10 1/4

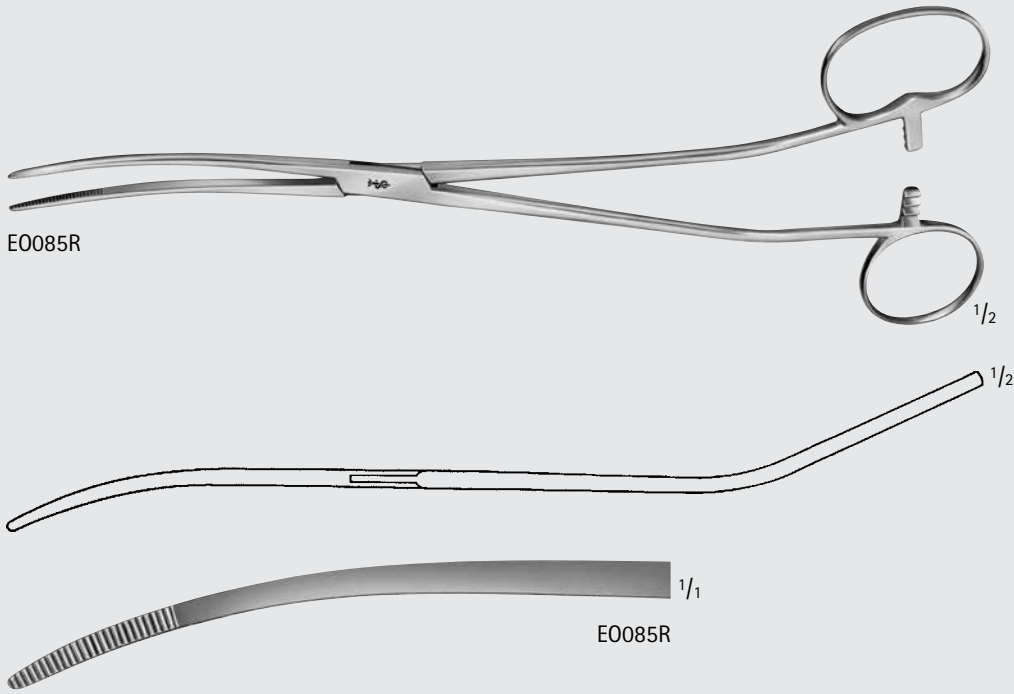

ADAIR Uterine Forceps

Catalog Number	Teeth	Length (in.)
EO106R	1 x 1	7 1/2

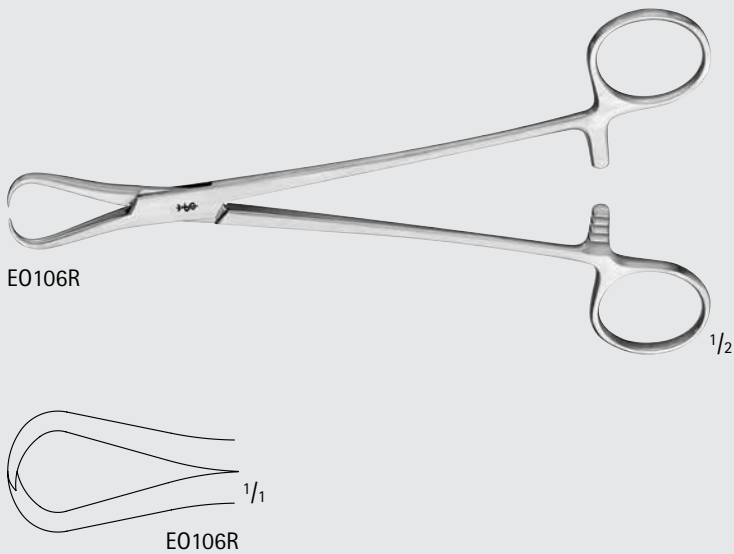

OB/GYN

Obstetrics/Gynecology

Tenaculum and Sponge Forceps

POZZI Tenaculum Forceps, Standard

Catalog Number	Teeth	Length (in.)
E0105R	1 x 1	6 7/8

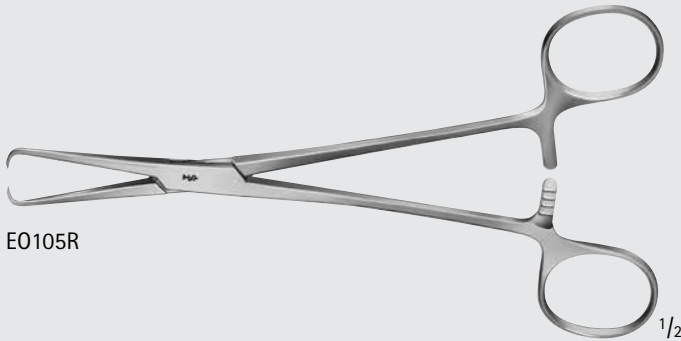

E0105R

1/2

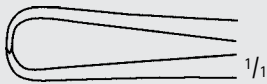

E0105R

1/1

BARRETT Uterine Tenaculum Forceps

Catalog Number	Teeth	Length (in.)
MG200R	1 x 1	7

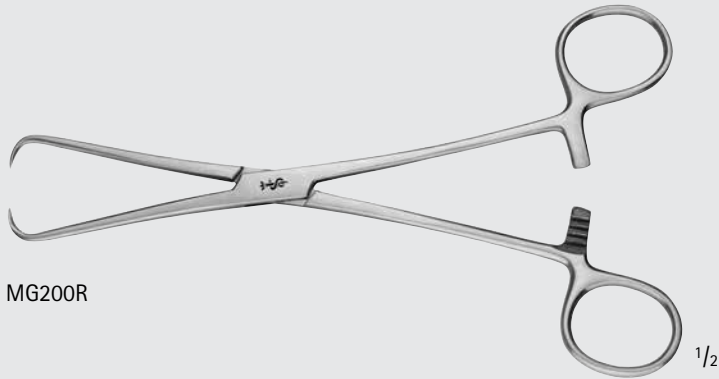

MG200R

1/2



MG200R

1/1

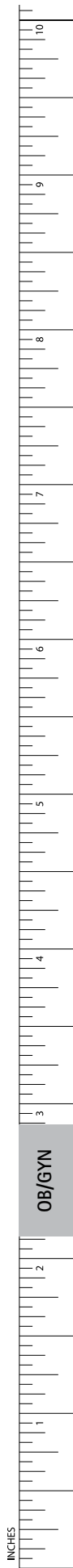

Obstetrics/Gynecology

Tenaculum and Sponge Forceps

BRAUN Tenaculum Forceps

Catalog Number	Teeth	Length (in.)
EO108R	1 x 1	9 3/4

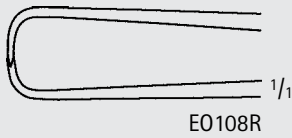
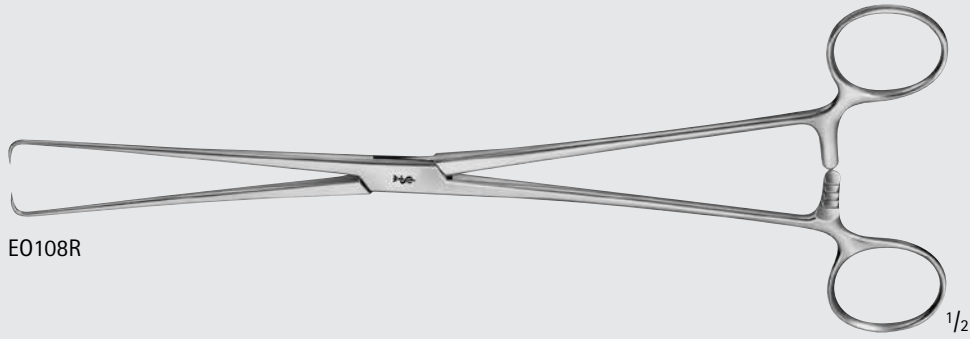

SCHROEDER Tenaculum Forceps

Catalog Number	Shaft	Teeth	Length (in.)
EO110R	STR	1 x 1	9 3/4

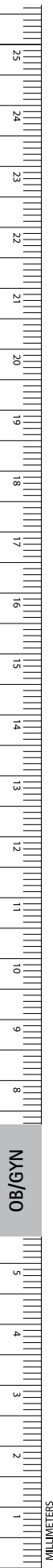
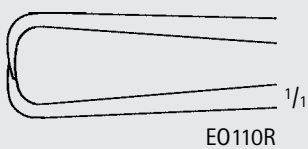
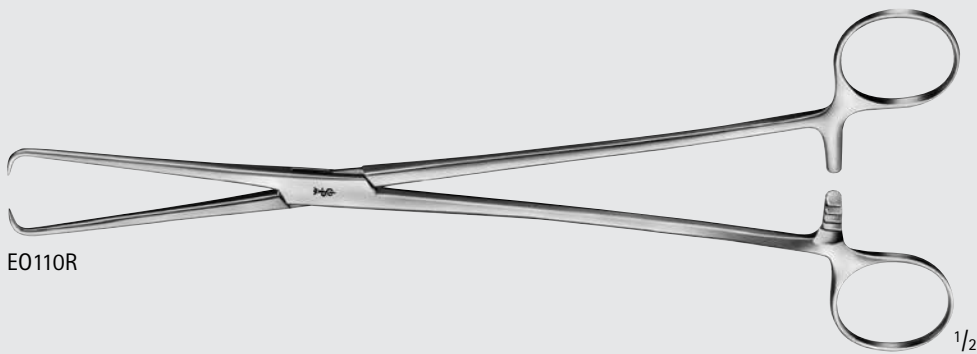

Obstetrics/Gynecology

Tenaculum and Sponge Forceps

SCHROEDER Tenaculum Forceps

Catalog Number	Shaft	Teeth	Length (in.)
E0150R	STR	2 x 2	9 3/4
E0151R	CVD	2 x 2	9 3/4
E0163R	STR	3 x 3	10 5/8

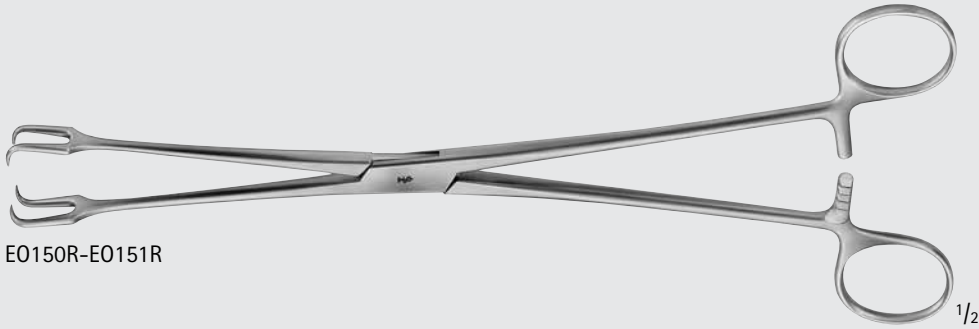

E0150R-E0151R



E0150R



E0151R

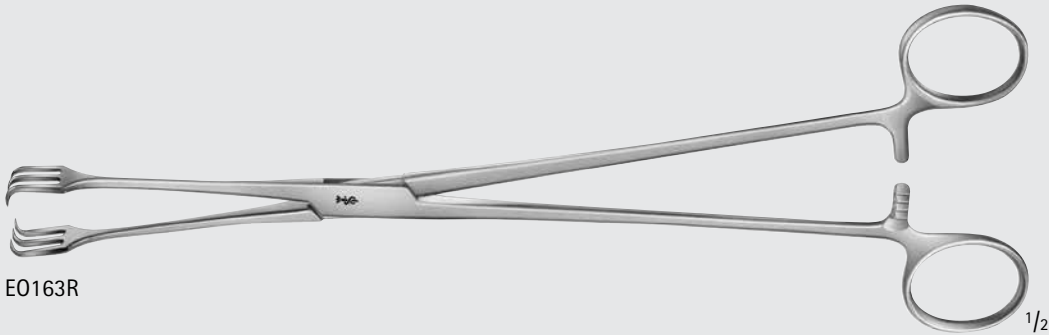

E0163R

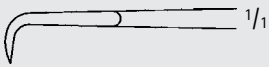

E0163R

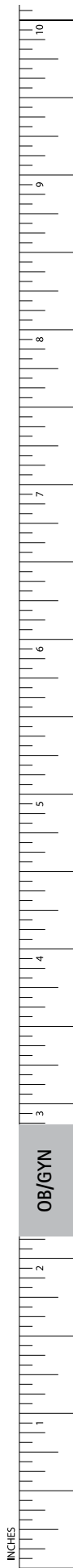

Obstetrics/Gynecology

Tenaculum and Sponge Forceps

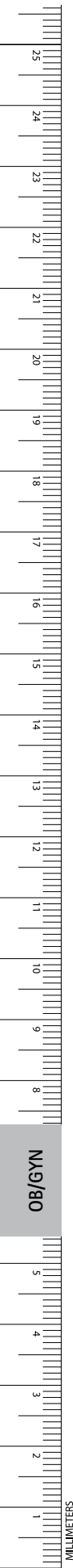

POZZI Tenaculum Forceps, Heavy

Catalog Number	Teeth	Length (in.)
EO125R	1 x 1	10



EO125R

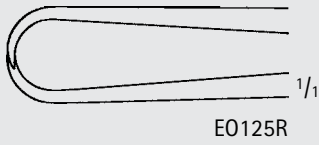

EO125R

DUPLAY Tenaculum Forceps, Delicate

Catalog Number	Teeth	Length (in.)
EO130R	1 x 1	9 3/4

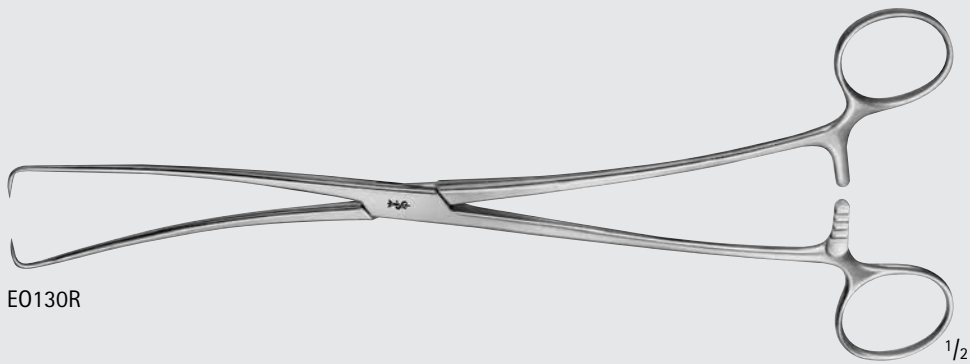

EO130R

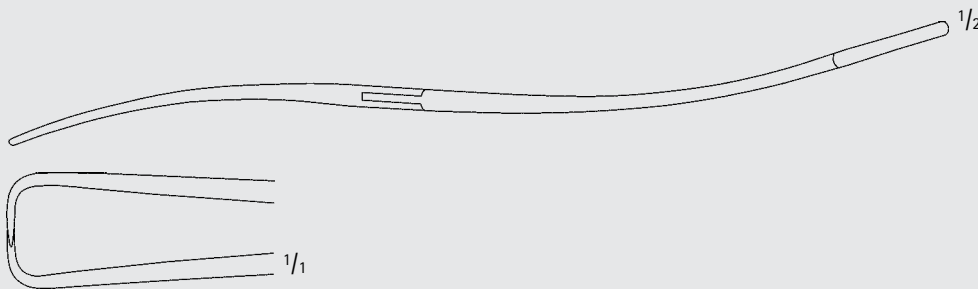

EO130R

Obstetrics/Gynecology

Tenaculum and Sponge Forceps

ABEL Tenaculum Forceps

Catalog Number	Teeth	Length (in.)
EO140R	1 x 1	11



EO140R

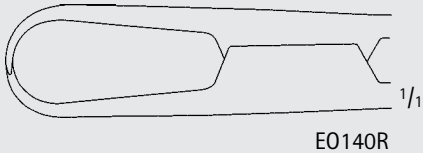

EO140R

HENROTIN Uterine Vulsellum Forceps

Catalog Number	Teeth	Length (in.)
MG202R	2 x 3	8 1/4

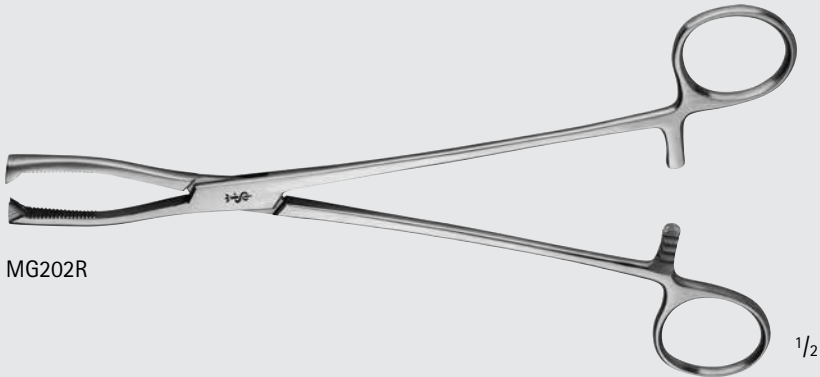

MG202R



1/1



1/1



MG202R

1/2

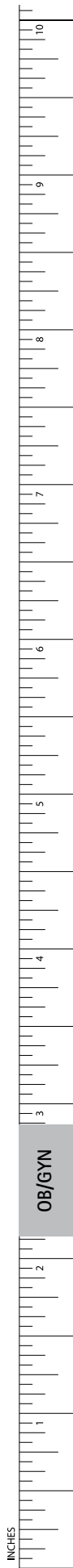

Obstetrics/Gynecology

Tenaculum and Sponge Forceps

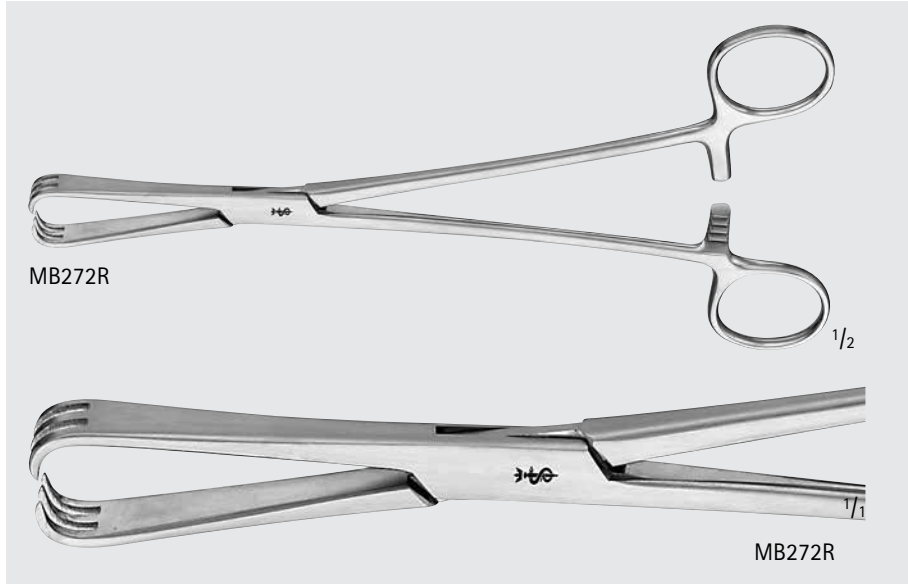
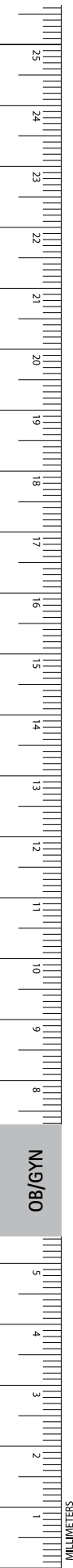

GORDON Uterine Vulsellum Forceps

Catalog Number	Teeth	Length (in.)
MB272R	3 x 3	8 3/4

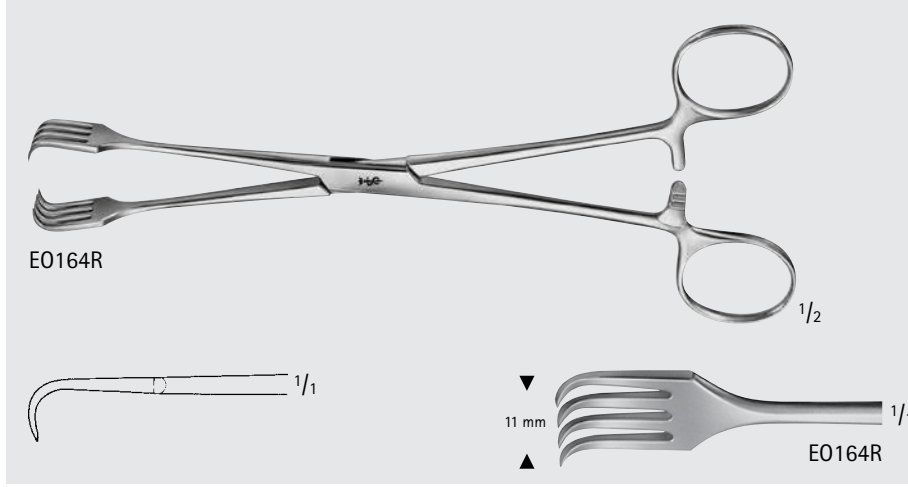

CZERNY Uterine Tenaculum Forceps

Catalog Number	Teeth	Length (in.)
EO164R	4 x 4	7 7/8

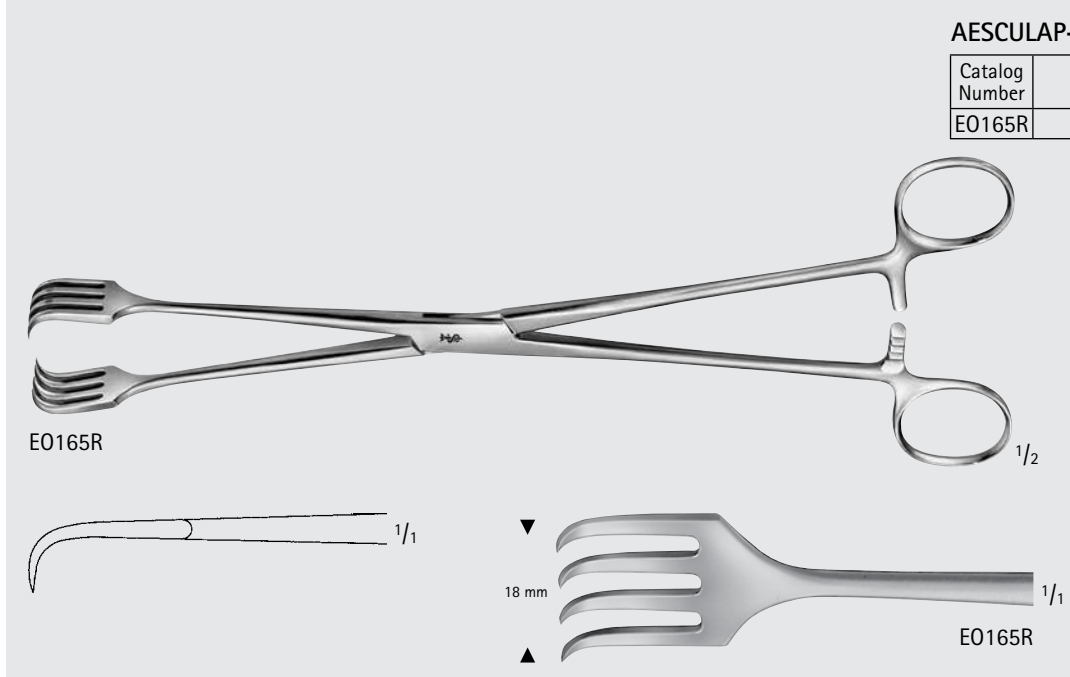

AESCULAP-PRATT Tenaculum Forceps

Catalog Number	Teeth	Length (in.)
EO165R	4 x 4	10 1/4

Obstetrics/Gynecology

Tenaculum and Sponge Forceps

PRATT Tenaculum Forceps

Catalog Number	Teeth	Length (in.)
EO166R	4 x 4	10 5/8



EO166R

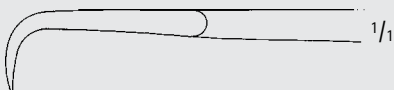

TEALE Tenaculum Forceps

Catalog Number	Teeth	Length (in.)
MG184R	3 x 4	9 5/8
EO180R	3 x 4	10

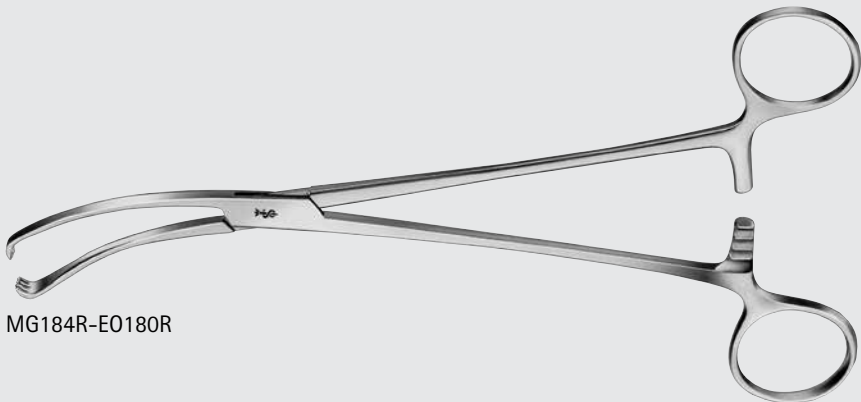

MG184R-EO180R

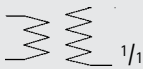

MG184R-EO180R

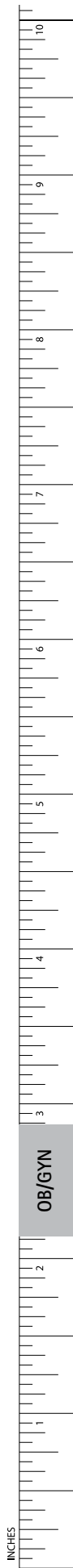

Obstetrics/Gynecology

Tenaculum and Sponge Forceps

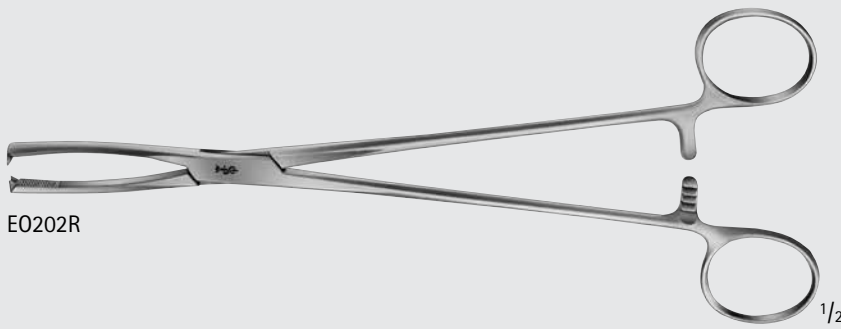
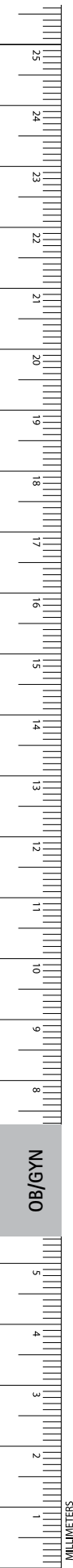

EO202R



EO202R

JACOBS Vulsellum Forceps

Catalog Number	Teeth	Length (in.)
EO202R	2 x 2	8 1/2

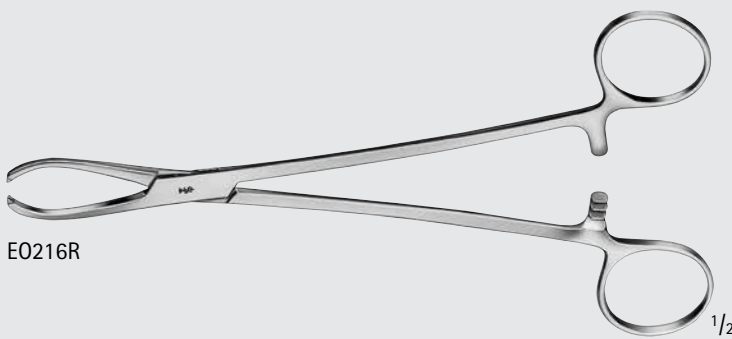

EO216R

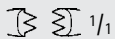

EO216R

LITTLEWOOD Tenaculum Forceps

Catalog Number	Teeth	Length (in.)
EO216R	2 x 3	7 1/4

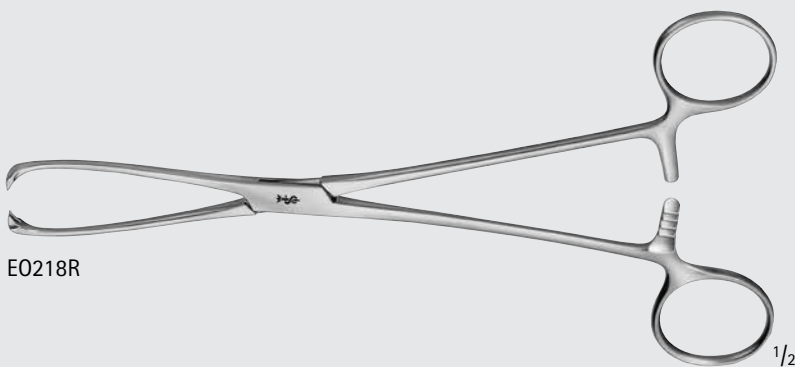

EO218R

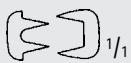

EO218R

MUSEUX Tenaculum Forceps, Small

Catalog Number	Teeth	Length (in.)
EO218R	2 x 2	7 7/8

Obstetrics/Gynecology

Tenaculum and Sponge Forceps

MUSEUX Tenaculum Forceps

Catalog Number	Jaw	Length (in.)
E0220R	STR	9 1/2
E0221R	STR	9 1/2
E0222R	STR	9 1/2

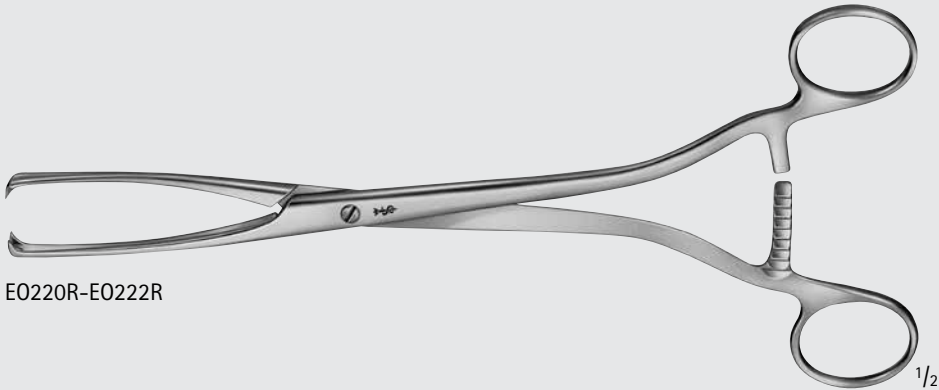

E0220R-E0222R

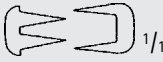

E0220R

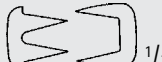

E0221R



E0222R

MUSEUX Tenaculum Forceps

Catalog Number	Jaw	Length (in.)
E0225R	CVD	9 1/2

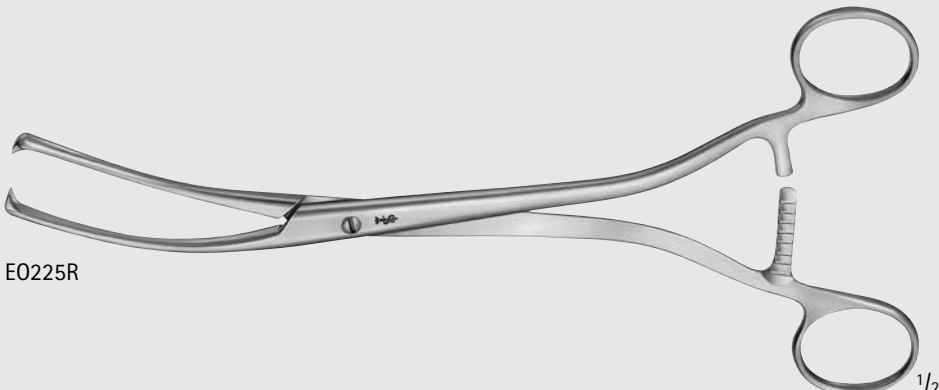

E0225R

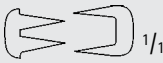

E0225R

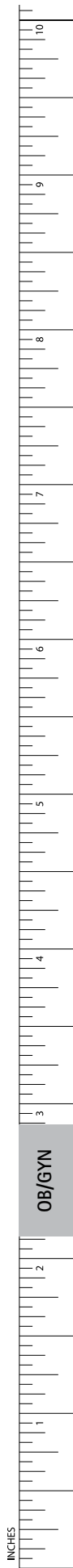

Obstetrics/Gynecology

Tenaculum and Sponge Forceps

MUSEUX Tenaculum Forceps

Catalog Number	Jaw	Size	Length (in.)
E0240R	STR	LARGE	10 1/2
E0242R	STR	X-LARGE	10 1/2



E0240R-E0242R

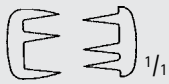

E0240R

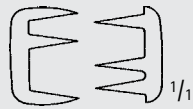

E0242R

FLETCHER-VAN DOREN Uterine Polyp, Sponge Holding Forceps

Catalog Number	Length (in.)
MB273R	9 1/2

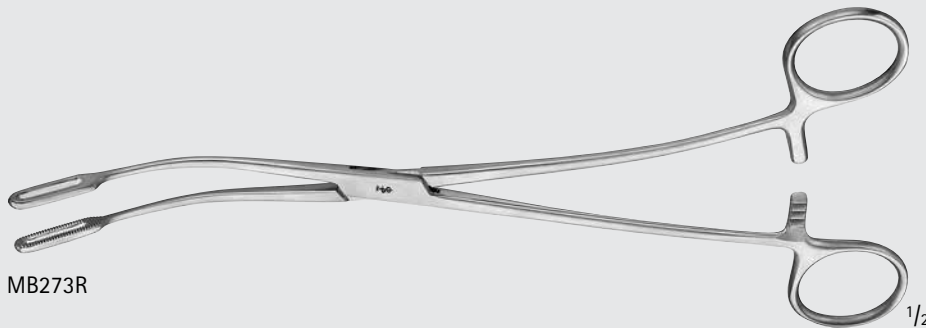

MB273R



MB273R



FLETCHER Sponge Forceps

Catalog Number	Tip	Length (in.)
MG193R	STR	9 3/4

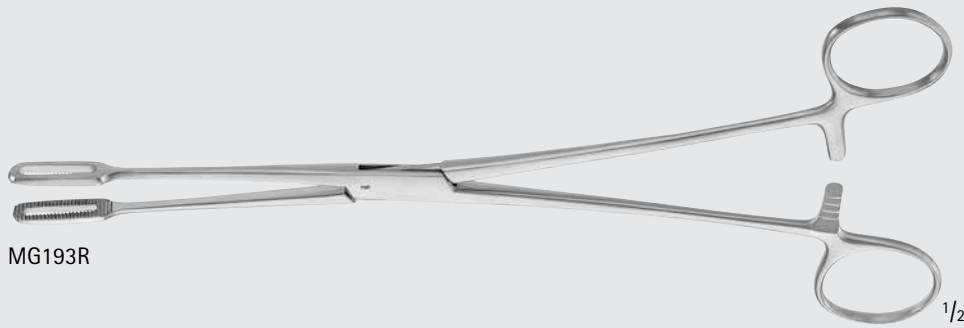

OVERSTREET Endometrial Polyp Forceps

Catalog Number	Jaw	Length (in.)
MG195R	HOLLOW, FENESTRATED	9 1/4

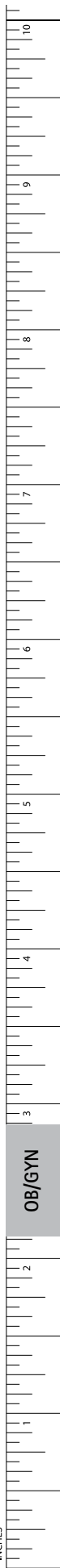
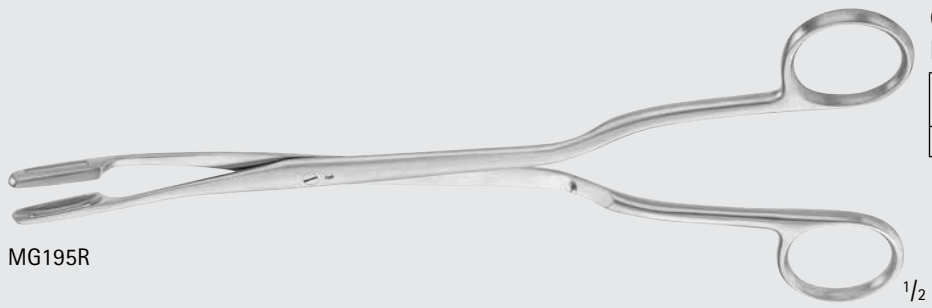

Obstetrics/Gynecology

Polyp Forceps

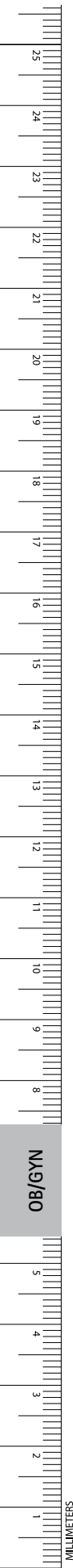

HEYWOOD-SMITH Polyp Forceps

Catalog Number	Length (in.)
EO310R	9 3/4

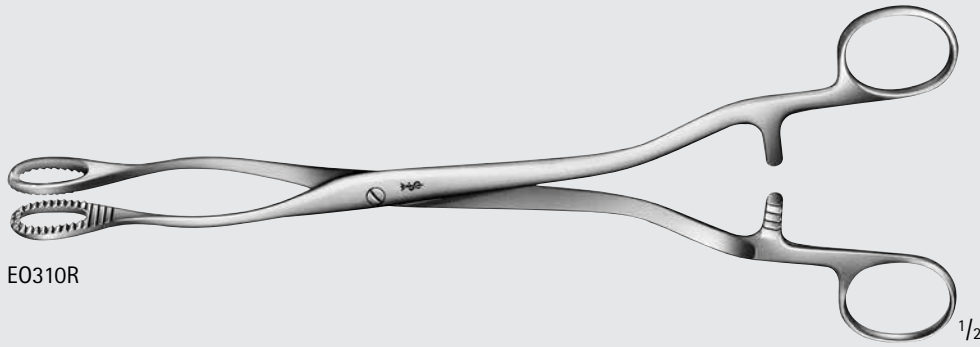

EO310R

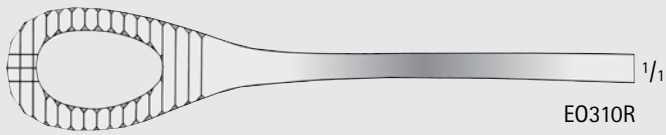

NOTO Polyp Forceps

Catalog Number	Length (in.)
EO315R	11

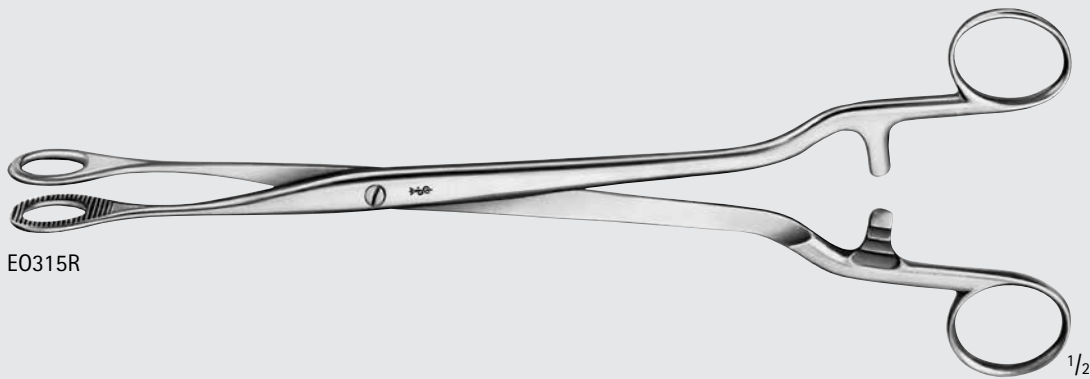

EO315R

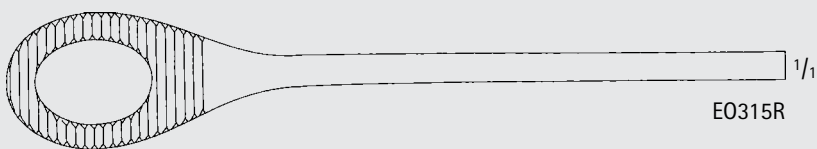

DOYEN Ovum Forceps

Catalog Number	Length (in.)
E0332R	7 1/4

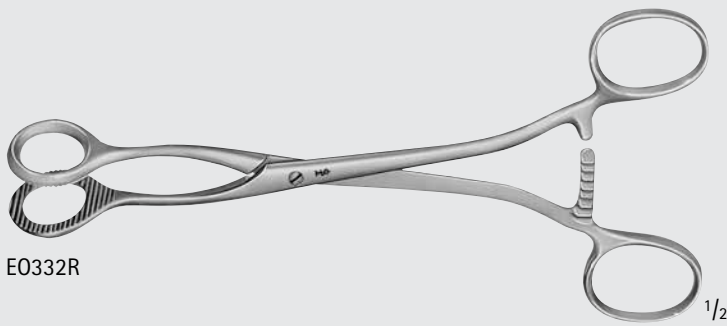

E0332R

1/2

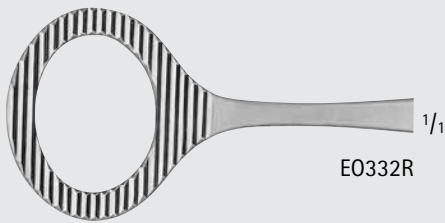

E0332R

1/1

Atraumatic Ovum Forceps

Catalog Number	Tip	Length (in.)
E0338R	SMALL	9 3/4

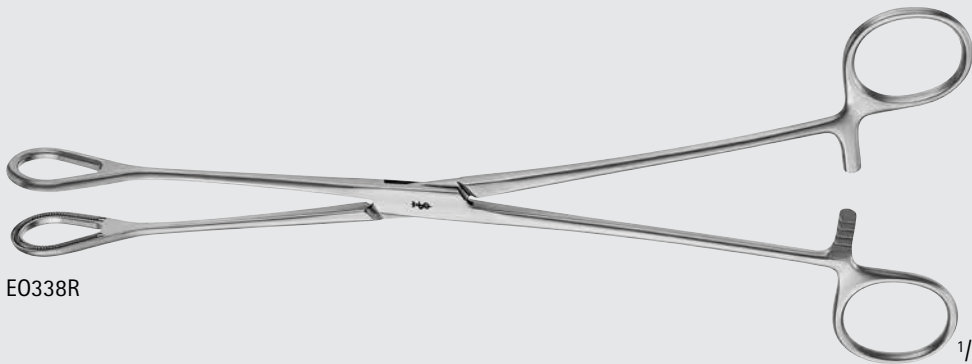

E0338R

1/2

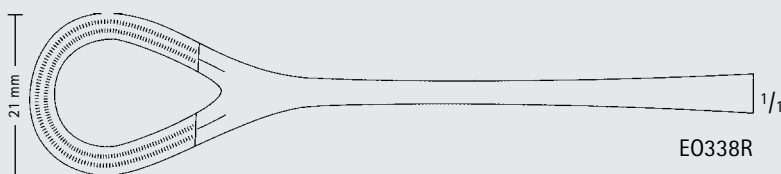

E0338R

1/1

21 mm

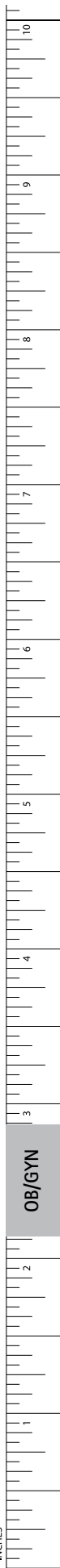

OB/GYN

INCHES

Obstetrics/Gynecology

Uterine Elevating Forceps

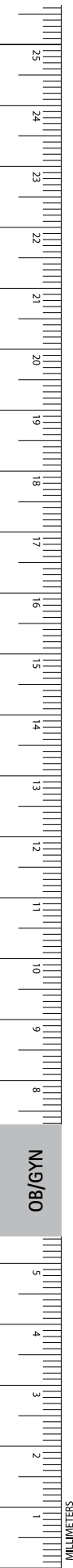

DARTIGUES Elevating Forceps

Catalog Number	Length (in.)
EO407R	10

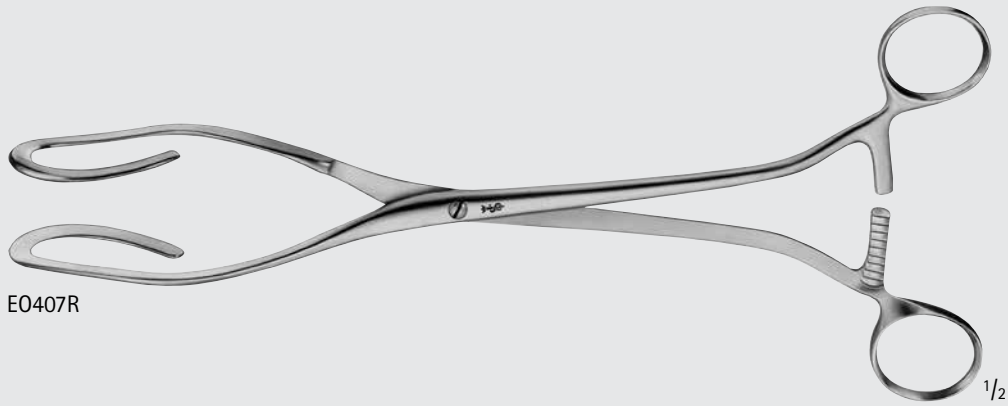

EO407R

SOMER Uterine Elevating Forceps

Catalog Number	Length (in.)
EO415R	9 1/4



EO415R

COLLIN Uterine Elevating Forceps

Catalog Number	Length (in.)
EO405R	11 1/4

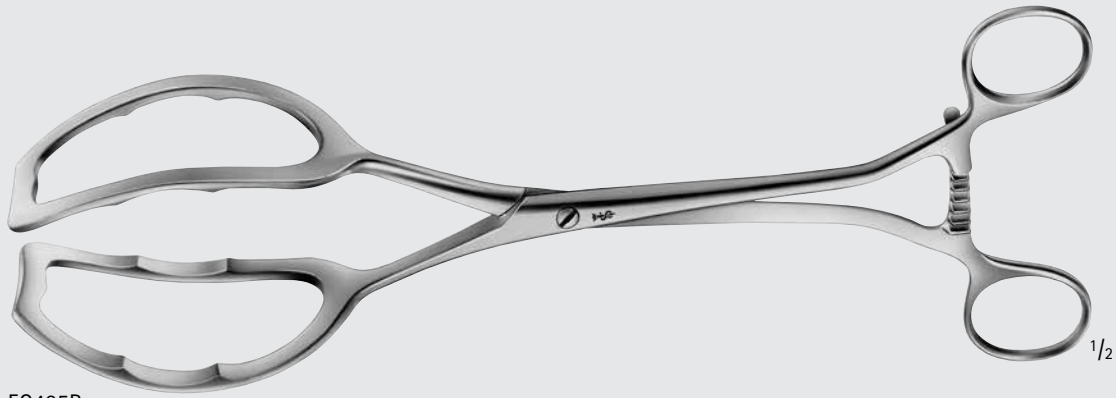

EO405R

COLLIN Uterine Elevating Forceps, Movable Jaw

Catalog Number	Blade	Length (in.)
EO420R	STR	10 1/2

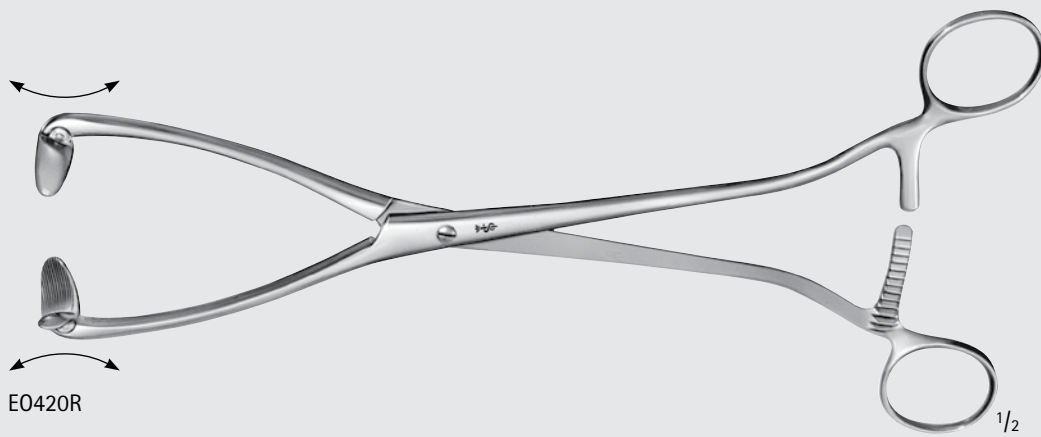

EO420R

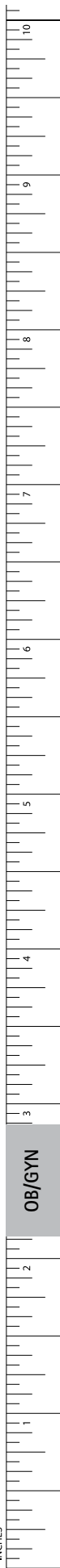

Obstetrics/Gynecology

Uterine Elevating and Membrane Forceps

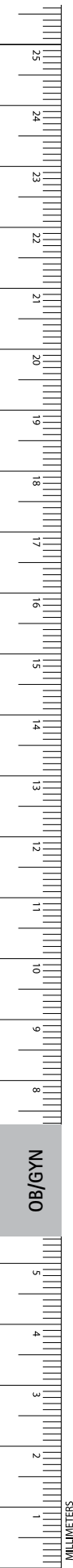

HULKA-KENWICK Uterine Elevating Forceps

Catalog Number	Length (in.)
E0422R	10 3/4

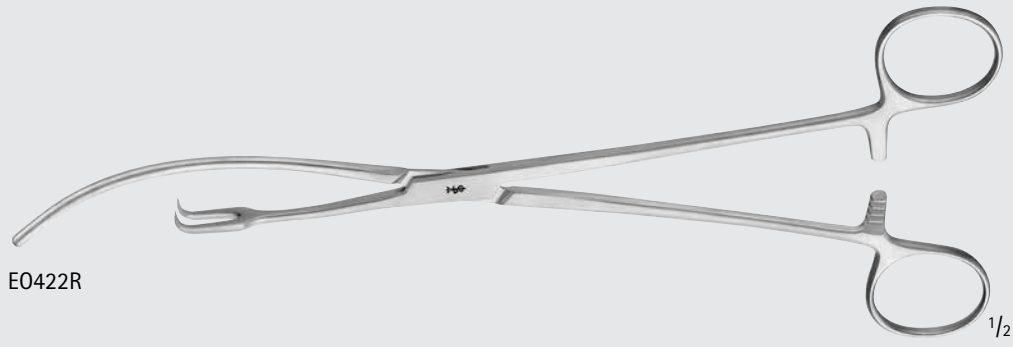

E0422R

1/2



E0422R

1/1

IOWA Membrane Puncturing Forceps

Catalog Number	Length (in.)
MG189R	10

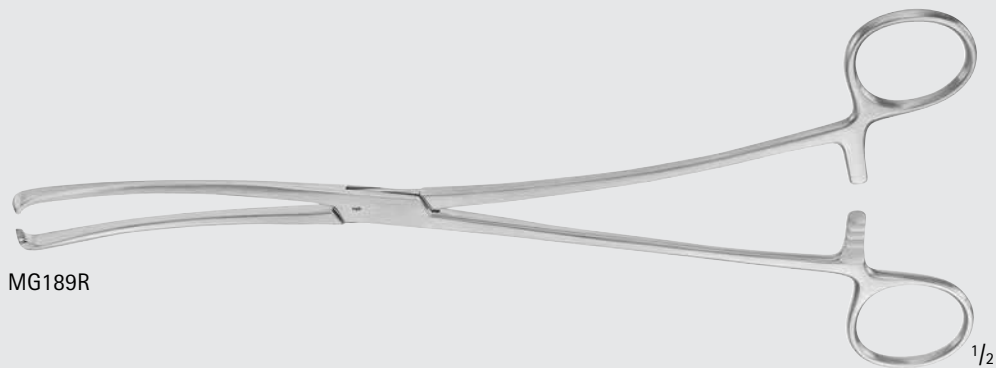

MG189R

1/2



MG189R

1/1

DOYEN Myoma Screw

Catalog Number	Length (in.)
E0433R	6
E0435R	7 1/2

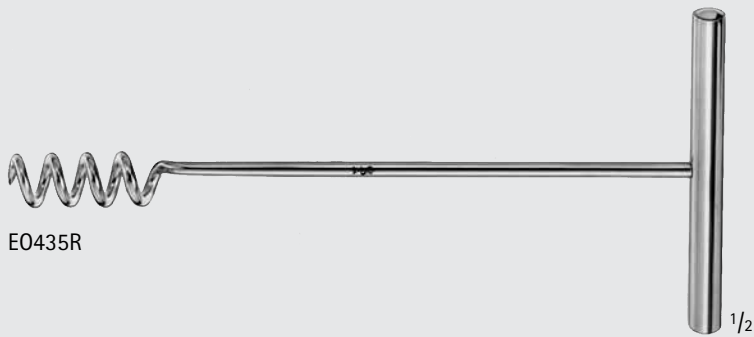

Obstetrics/Gynecology

Obstetrical Forceps

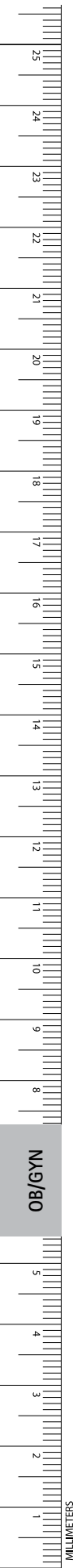

NAEGELE Obstetrical Forceps

Catalog Number	Length (in.)
ET205R	14

ET205R $\frac{1}{3}$

Detailed description: A pair of obstetrical forceps with long, curved blades and a single handle with a bulbous grip. The blades are designed for internal rotation. The handle has a small circular detail near the base of the blades.

KIELLAND Obstetrical Forceps

Catalog Number	Length (in.)
ET210R	16 1/2

ET210R $\frac{1}{3}$

Detailed description: A pair of obstetrical forceps with long, curved blades and two handles. The blades are designed for external rotation. The handles have a serrated grip and a central locking mechanism.

SIMPSON-BRAUN Obstetrical Forceps

Catalog Number	Length (in.)
ET220R	12
ET221R	13 3/4

ET220R $\frac{1}{3}$

ET221R $\frac{1}{3}$

Detailed description: Two models of Simpson-Braun obstetrical forceps. ET220R has a single handle with a bulbous grip and long, curved blades. ET221R has two handles with a serrated grip and long, curved blades. Both are designed for internal rotation.



DE LEE Obstetrical Forceps

Catalog Number	Length (in.)
MG190R	12
MG185R	14

MG190R-MG185R



ELLIOTT Obstetrical Forceps

Catalog Number	Length (in.)
MG191R	15

MG191R

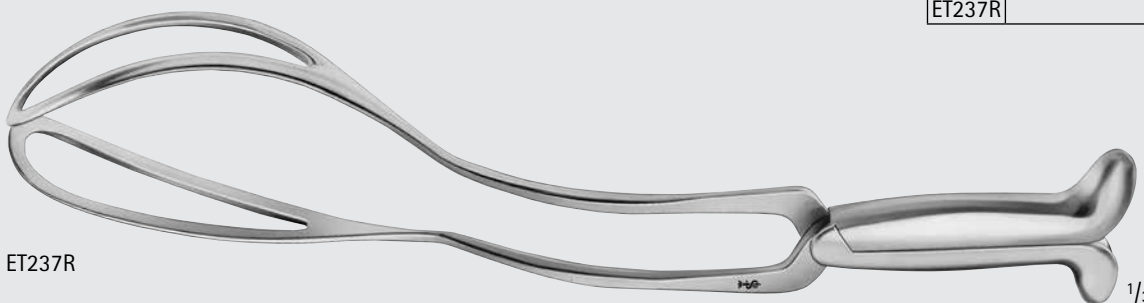

PIPER Obstetrical Forceps, F/ Breach

Catalog Number	Length (in.)
ET237R	17 1/2

ET237R

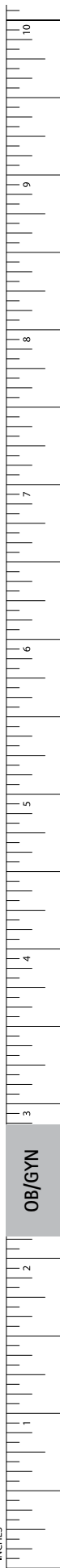

OB/GYN

INCHES

Obstetrics/Gynecology

Obstetrical Forceps



ET245R

SIMPSON C-Section Forceps

Catalog Number	Length (in.)
ET245R	9 1/4



ET255R

**BARNES-NEVILLE Obstetrical Forceps,
With Traction Handle**

Catalog Number	Length (in.)
ET255R	17 1/8

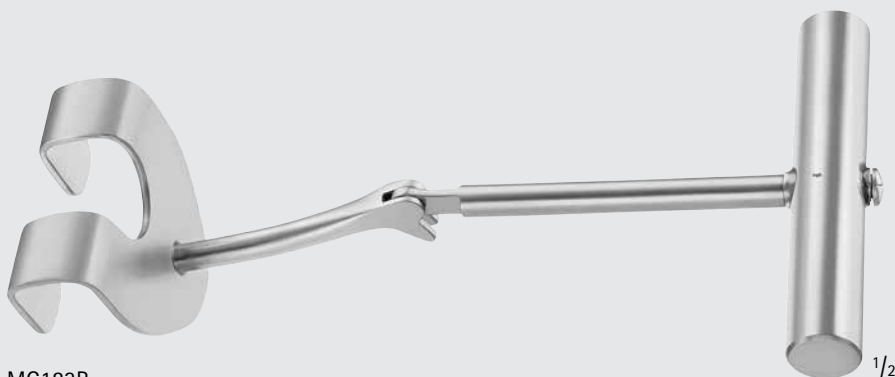

MG183R

BILL Traction Handle

Catalog Number	Description
MG183R	FOR USE W/ STANDARD OB FORCEPS

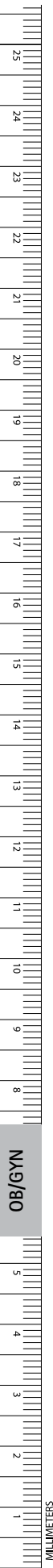

OB/GYN

LUIKART-SIMPSON Obstetrical Forceps

Catalog Number	Length (in.)
MB298R	14



MB298R

LUIKART-MCLANE Obstetrical Forceps

Catalog Number	Length (in.)
MB299R	15 1/2



MB299R

LUIKART-KIELLAND Obstetrical Forceps

Catalog Number	Length (in.)
MB069R	15 1/2

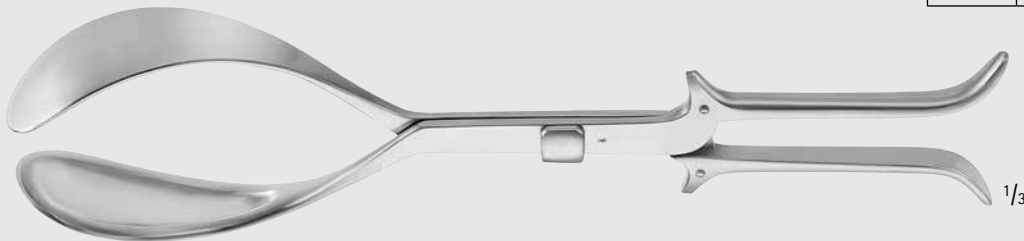

MB069R

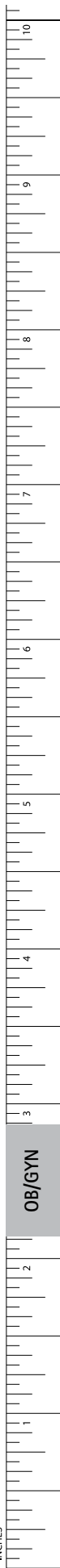

Obstetrics/Gynecology

Obstetrical Forceps and Head Extractor

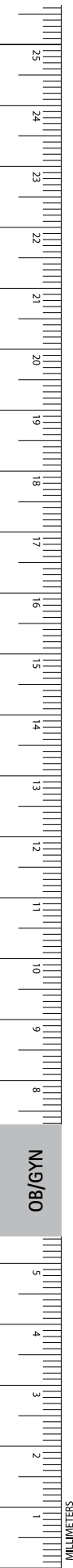

LUIKHART Obstetrical Forceps

Catalog Number	Length (in.)
MG186R	16



MG186R

MCLANE-TUCKER Obstetrical Forceps

Catalog Number	Length (in.)
MG192R	16 1/4



MG192R

MURLESS Head Extractor

Catalog Number	Length (in.)
MG492R	10

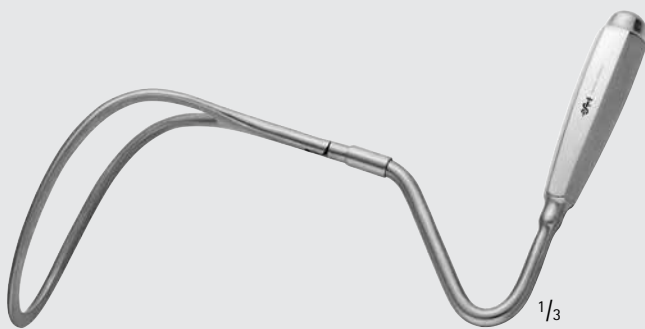

MG492R

Obstetrics/Gynecology

C-Section Forceps and Obstetric Lever

SELLHEIM Obstetric Lever

Catalog Number	Blade	Length (in.)
ET270R	OPEN	11 3/4



ET270R

1/2



ET270R

1/2

GREEN-ARMYTAGE Forceps, F/ C-Section

Catalog Number	Length (in.)
ET269R	8 3/4

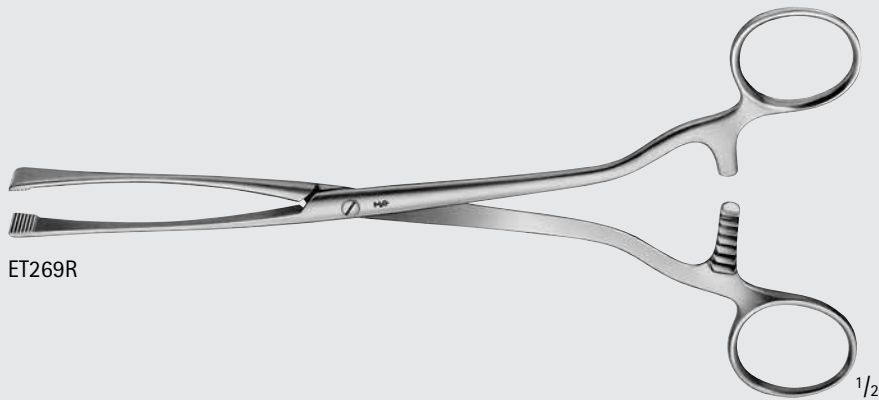

ET269R

1/2



ET269R

1/1

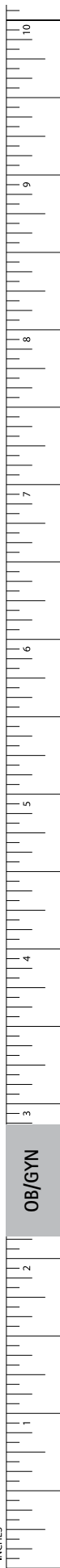

Obstetrics/Gynecology

Placenta and Ovum Forceps

BARRETT Placenta Forceps

Catalog Number	Blade	Length (in.)
MG201R	FENESTRATED	10

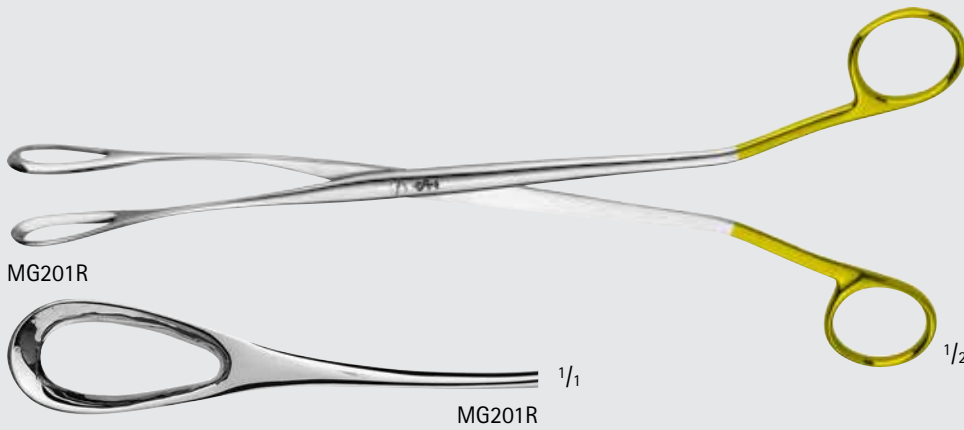

BIERER Ovum Forceps

Catalog Number	Jaw (mm)	Ratchet	Length (in.)
MG466R	16	NO	11
MG467R	16	YES	11
MG468R	19	NO	11
MG469R	19	YES	11

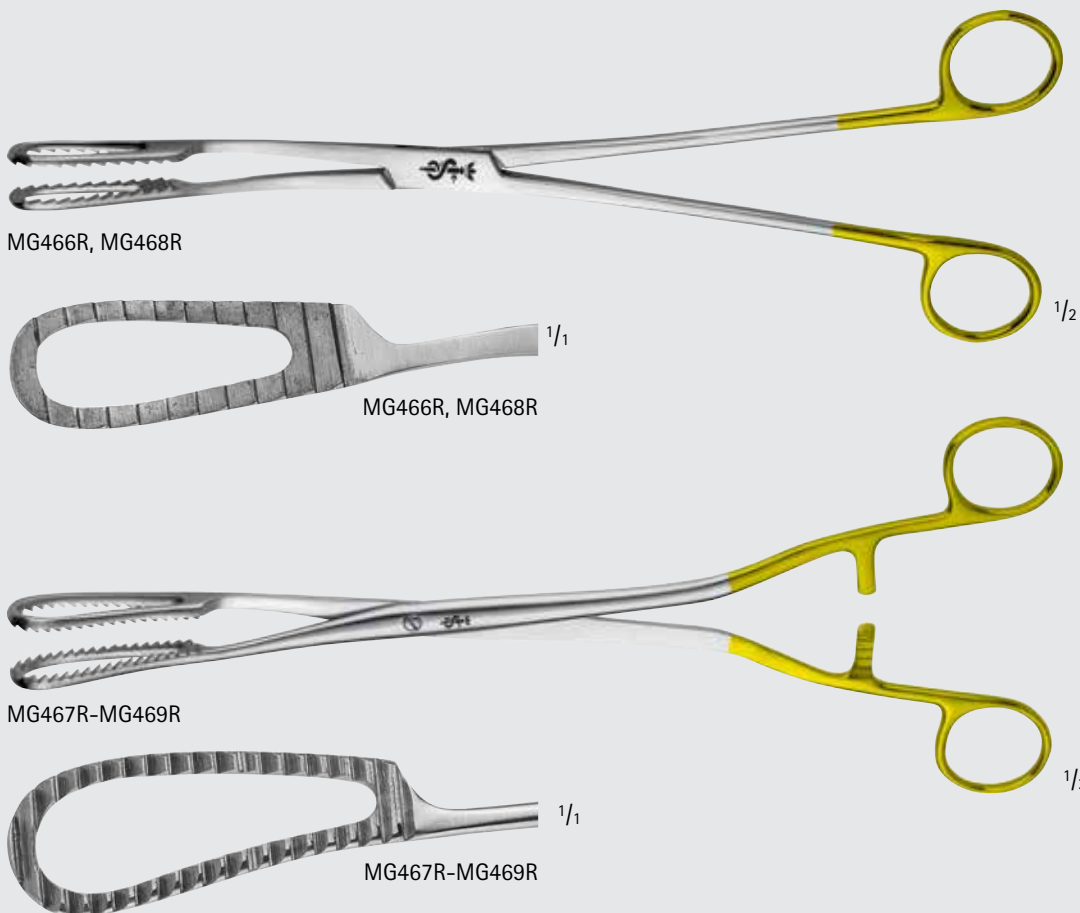

Obstetrics/Gynecology
Placenta and Ovum Forceps

WINTER Placenta and Ovum Forceps,
W/O Ratchet

Catalog Number	Size (#)	Jaw	Length (in.)
ET301R	1	STR	11 1/2
ET302R	2	STR	11 1/2



ET301R-ET302R



ET301R



ET302R



Obstetrics/Gynecology

Placenta and Ovum Forceps

WINTER Placenta and Ovum Forceps, W/O Ratchet (continued)

Catalog Number	Size (#)	Jaw	Length (in.)
ET306R	1	CVD	11 1/2
ET307R	2	CVD	11 1/2
ET308R	3	CVD	11 1/2



ET306R-ET308R

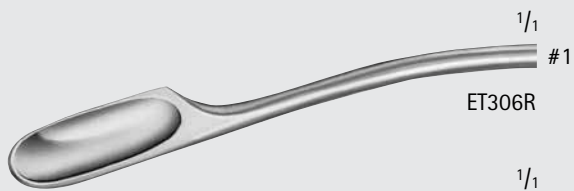

ET306R

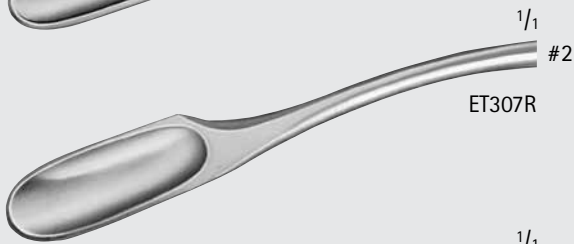

ET307R



ET308R

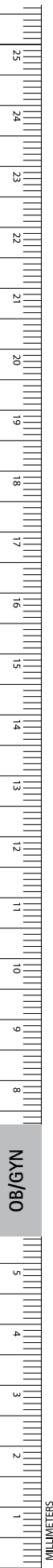

Obstetrics/Gynecology

Placenta and Ovum Forceps

WINTER Placenta and Ovum Forceps, W/ Ratchet

Catalog Number	Size (#)	Jaw	Length (in.)
ET315R	2	CVD	11 1/2
ET316R	3	CVD	11 1/2

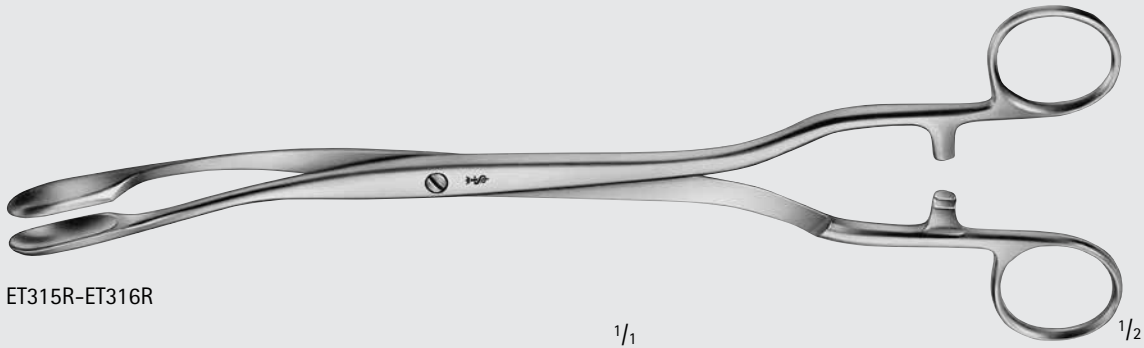

ET315R-ET316R

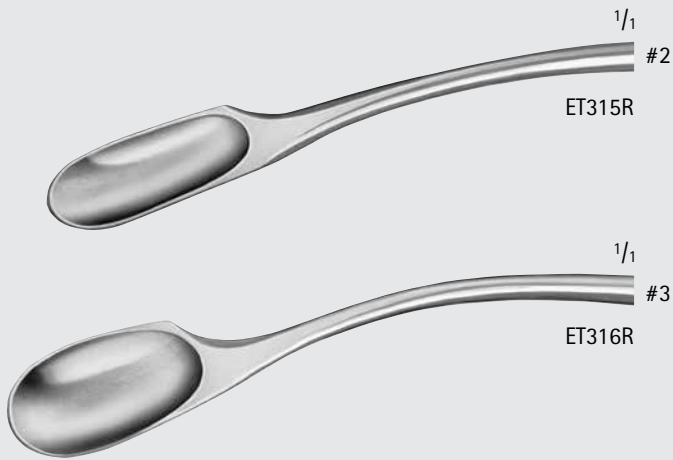

Obstetrics/Gynecology

Placenta and Ovum Forceps

SAENGER Placenta and Ovum Forceps, W/ Ratchet

Catalog Number	Jaw	Length (in.)
ET326R	STR	10 3/4
ET327R	CVD	10 1/2
ET325R	CVD	11 1/4

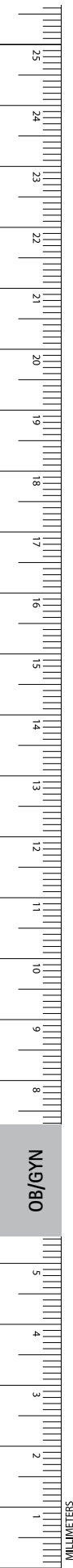
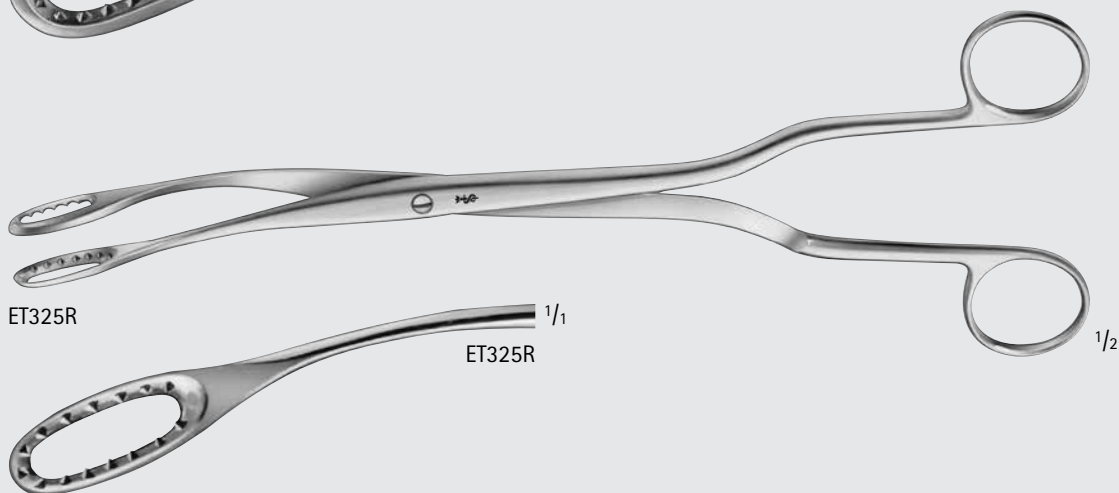
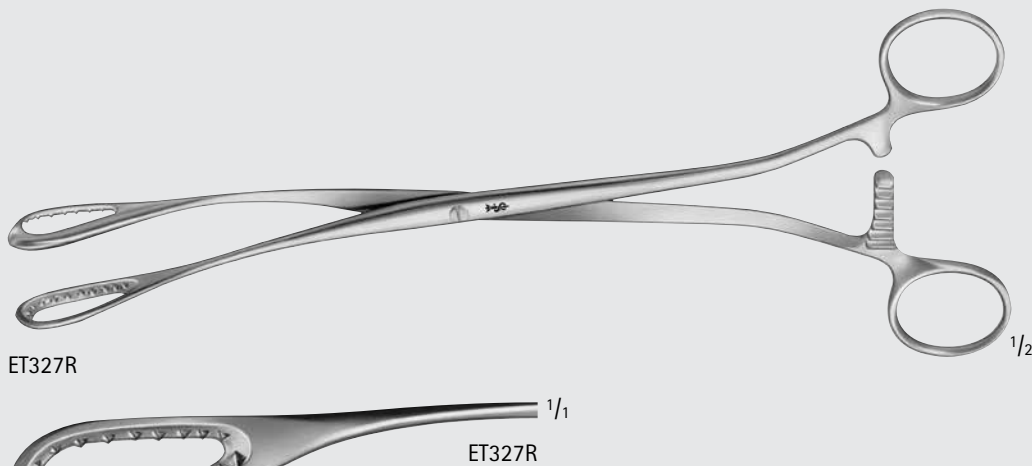
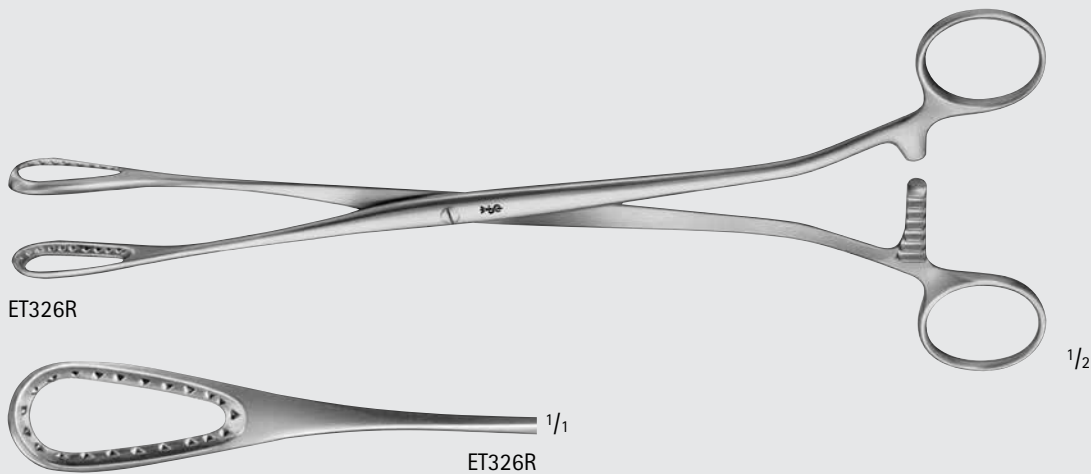

Obstetrics/Gynecology
Placenta and Ovum Forceps

MCCLINTOCK Placenta and Ovum
Forceps

Catalog Number	Length (in.)
ET329R	9 1/2

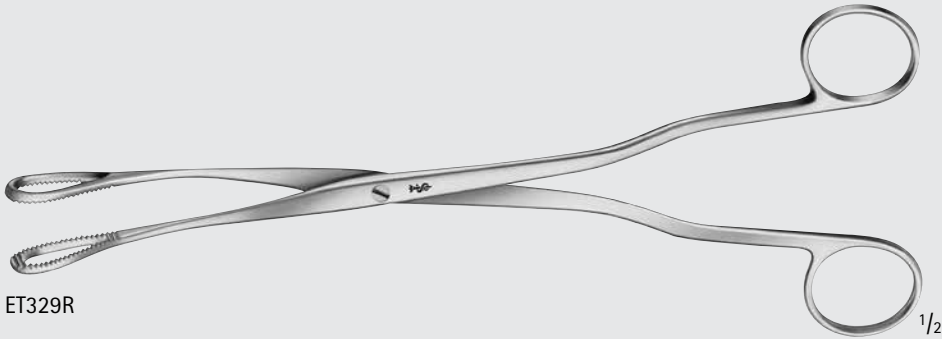

ET329R

1/2



ET329R

1/1

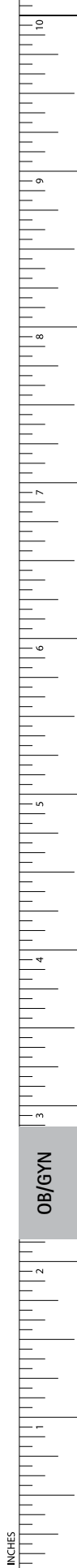

Obstetrics/Gynecology

Biopsy Forceps

THOMS-GAYLOR Biopsy Forceps, S-Shape

Catalog Number	Length (in.)
ER050R	9 1/2

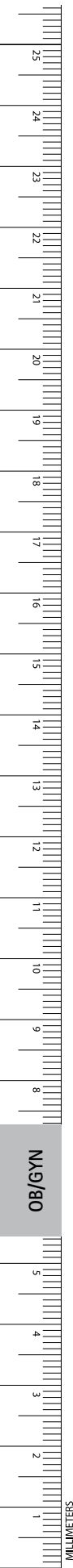
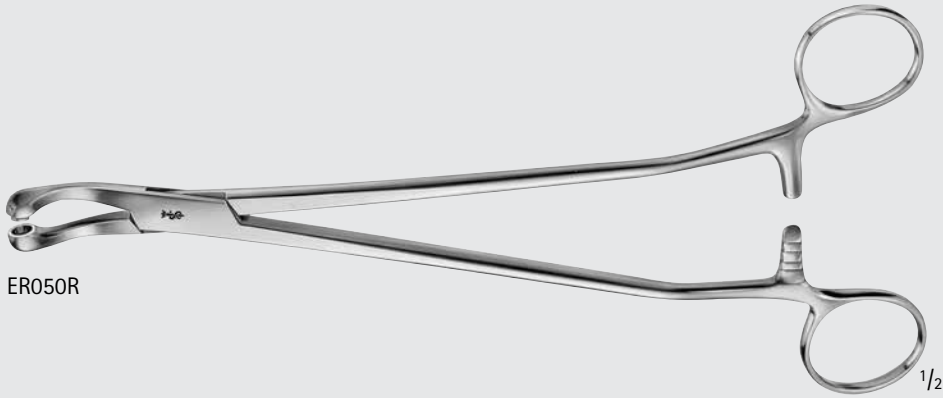

SCHUMACHER Biopsy Forceps, S-Shape

Catalog Number	Tip	Length (in.)
ER061R	SMALL	9 1/2
ER062R	LARGE	9 1/2

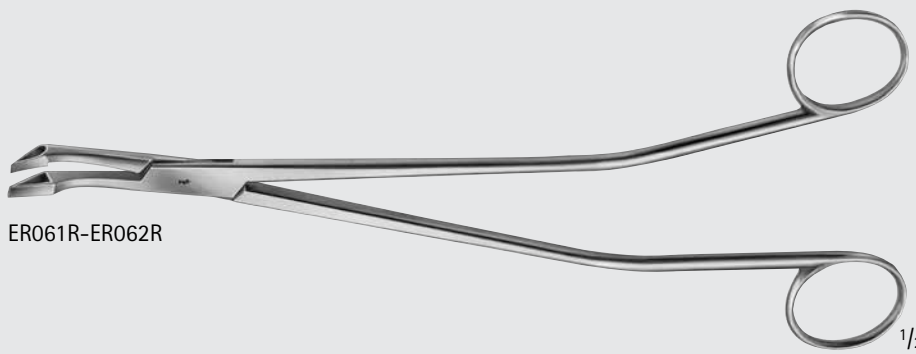

ER061R-ER062R



ER061R



ER062R

SCHUMACHER Biopsy Rongeur

Catalog Number	Tip	Length (in.)
ER063R	SMALL	9 1/2
ER064R	LARGE	9 1/2

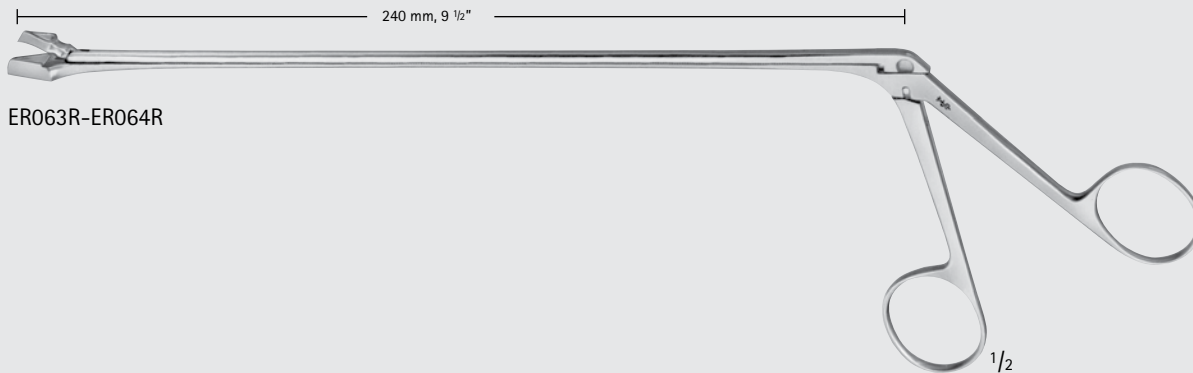

ER063R-ER064R



ER063R



ER064R



INCHES

Obstetrics/Gynecology

Biopsy Forceps

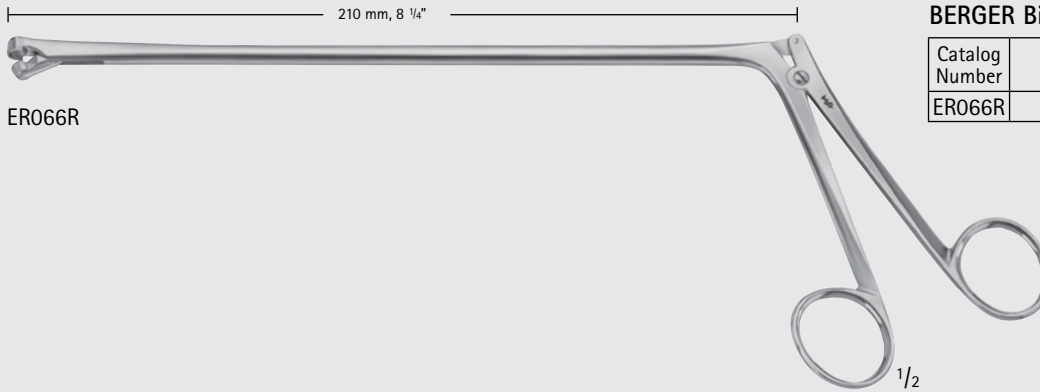

BERGER Biopsy Forceps

Catalog Number	Length (in.)
ER066R	8 1/4



TISCHLER Cervical Biopsy Punch Forceps

Catalog Number	Jaw Size (mm)	Working Length (in.)
ER068R	5 x 6 x 3	8 1/4
MG187R	7 x 3	11

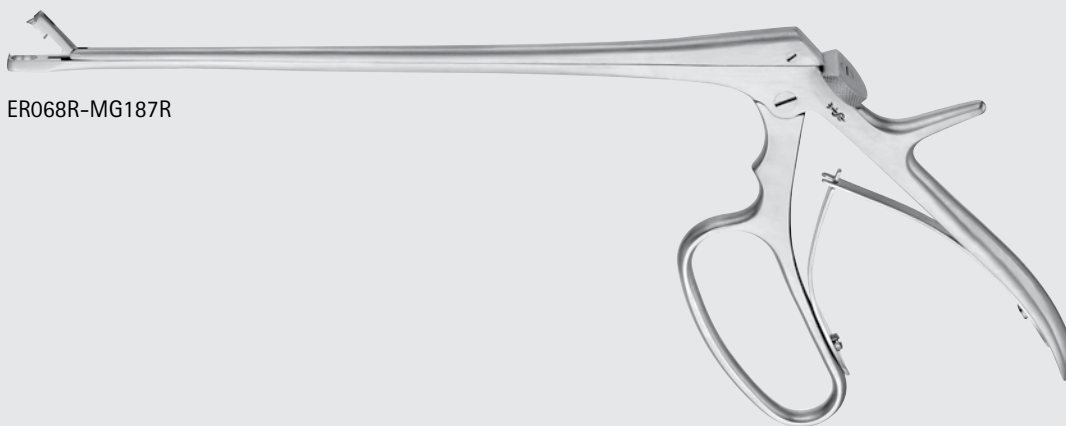

TISCHLER Biopsy Alligator Forceps

Catalog Number	Jaw	Jaw Size (mm)	Length (in.)
MG076R	OBLONG CUP SINGLE TOOTH	7 x 3	9 3/4



KEVORKIAN-YOUNGE Biopsy Forceps

Catalog Number	Jaw Size (mm)	Working Length (in.)
ER080R	8.5 x 3.5	10

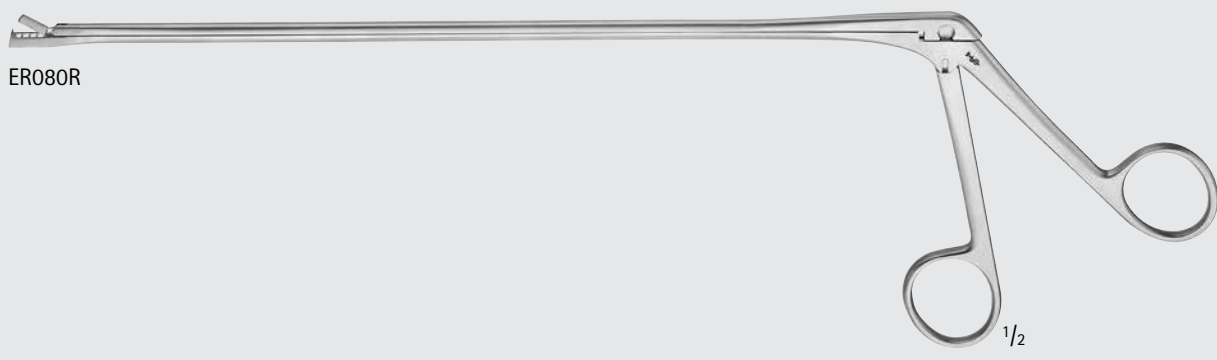

OB/GYN

INCHES

Obstetrics/Gynecology

Biopsy Forceps

WITTNER Biopsy Forceps

Catalog Number	Jaw	Jaw Size (mm)	Working Length (in.)
MG194R	STR. JAWS W/ TEETH	4 x 8	9

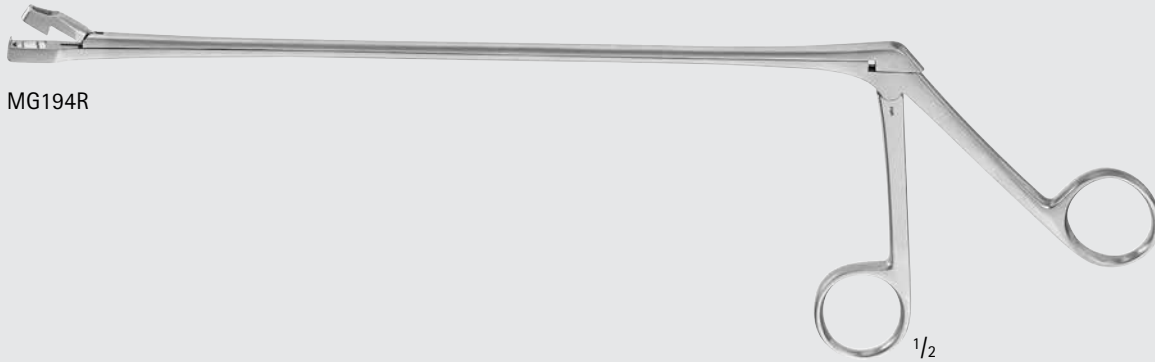

EPPENDORF Biopsy Forceps

Catalog Number	Jaw Size (mm)	Working Length (in.)
ER070R	8 x 4	8

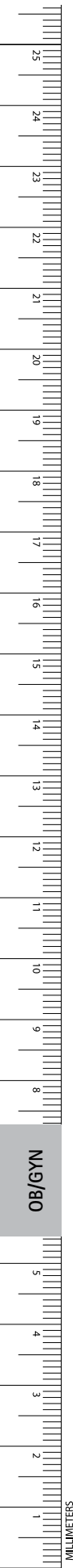
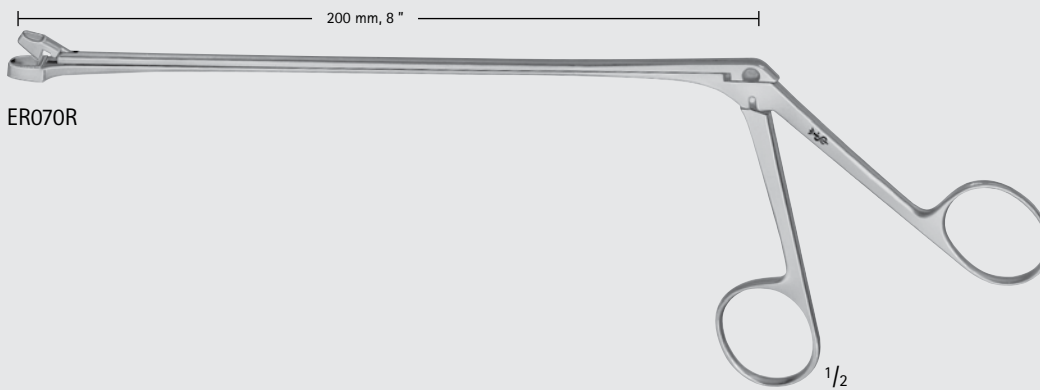

PHANEUF Hysterectomy Forceps

Catalog Number	Jaw	Length (in.)
BJ500R	STR	8 1/4
BJ501R	ANG	8

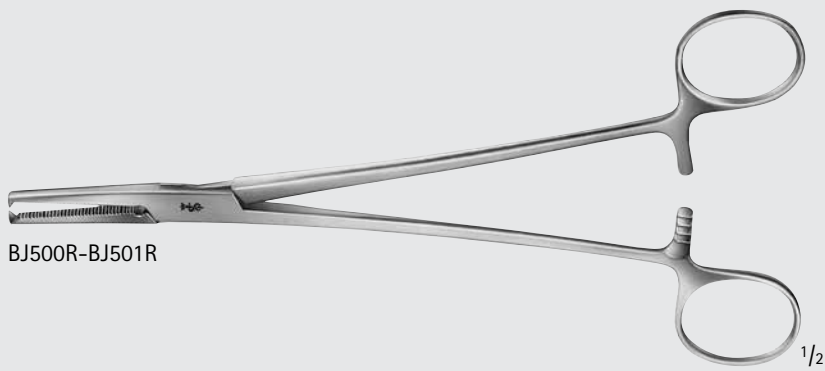

BJ500R-BJ501R



BJ500R



BJ501R

HOLZBACH Hysterectomy Forceps

Catalog Number	Jaw	Length (in.)
BJ510R	STR	9 5/8
BJ511R	CVD	9 5/8

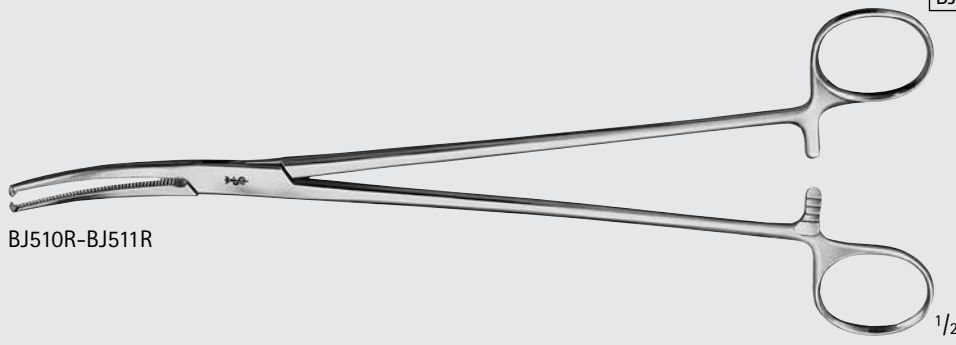

BJ510R-BJ511R



BJ510R



BJ511R

HEANEY-REZEK Hysterectomy Forceps

Catalog Number	Jaw	Length (in.)
BJ524R	STR	8 1/4

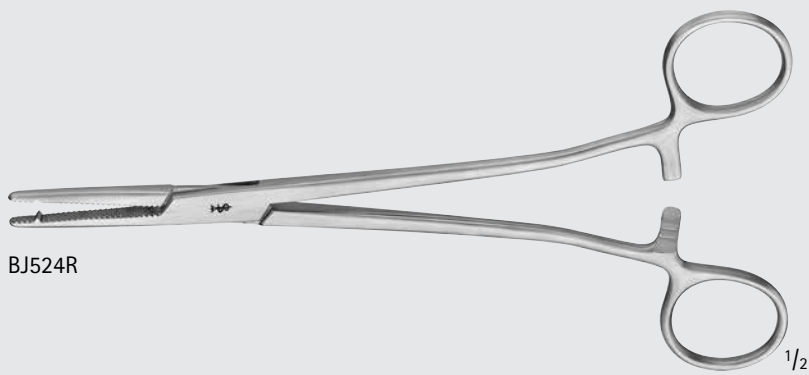

BJ524R



BJ524R

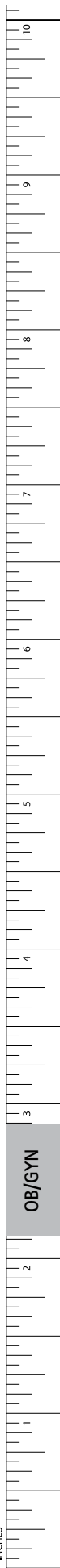

OB/GYN

Obstetrics/Gynecology

Clamps

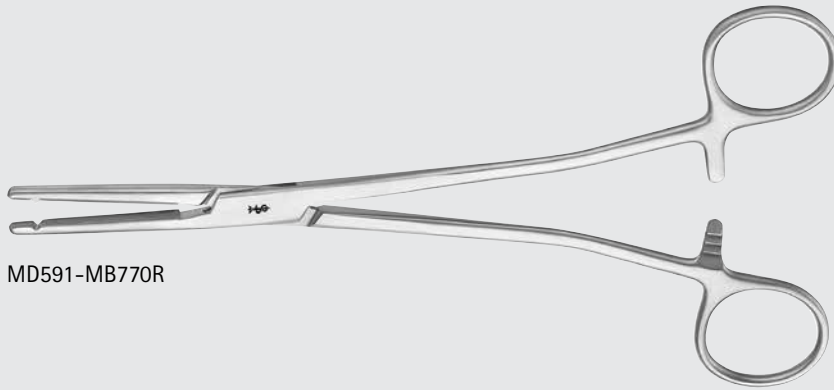

MD591-MB770R



MD591

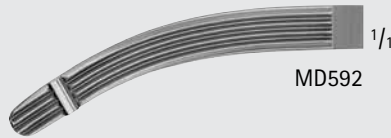

MD592

HEANEY-BALLENTINE Hysterectomy Forceps, Longitudinal Grooves

Catalog Number	Jaw	Length (in.)
MD591	STR	8 1/2
MB757R	STR	10 1/2
MB754R	STR	12
MB771R	STR	14
MD592	CVD	8 1/2
MB749R	CVD	10 1/2
MB753R	CVD	12
MB770R	CVD	14

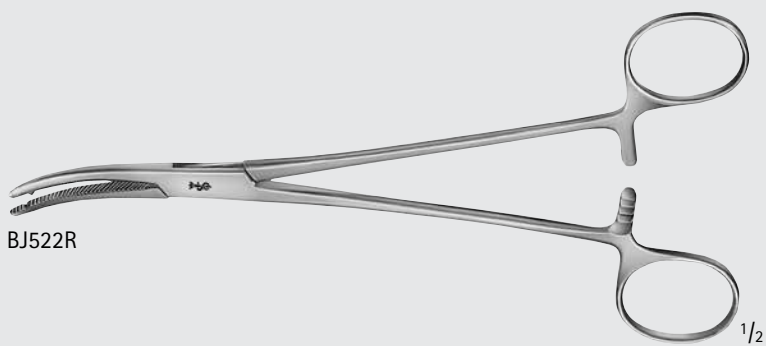

BJ522R

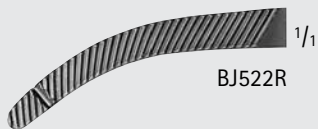

BJ522R

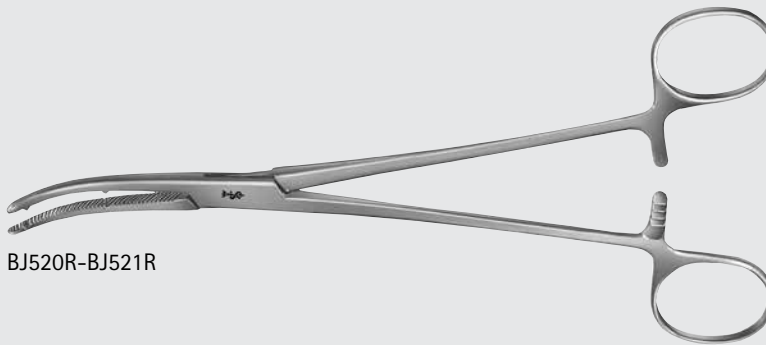

BJ520R-BJ521R

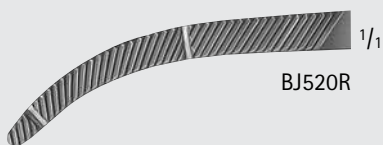

BJ520R

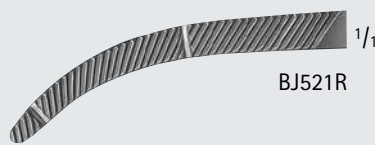

BJ521R

HEANEY Hysterectomy Forceps

Catalog Number	Jaw	Teeth	Length (in.)
BJ522R	CVD	1	7 3/4
BJ520R	CVD	2	8
BJ521R	CVD	2	9 3/4

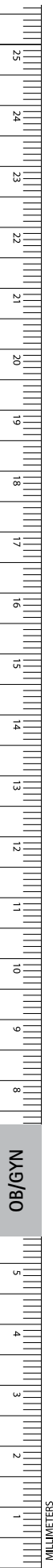

HEANEY Hysterectomy Forceps
(continued)

Catalog Number	Jaw	Teeth	Length (in.)
MB906R	STR	2	12
MB907R	CVD	2	12

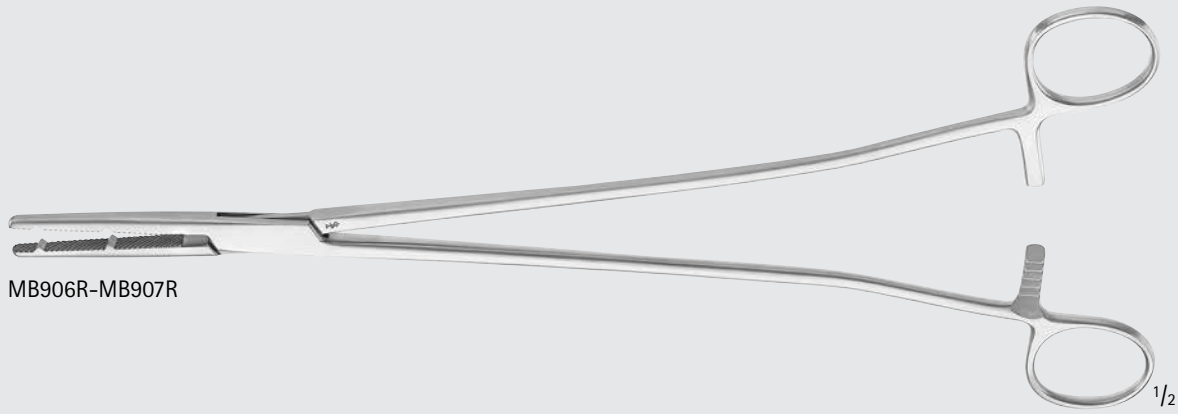

MB906R-MB907R



MB906R



MB907R

HEANEY Hysterectomy Forceps, Heavy

Catalog Number	Jaw	Length (in.)
MB797R	CVD	8 1/4

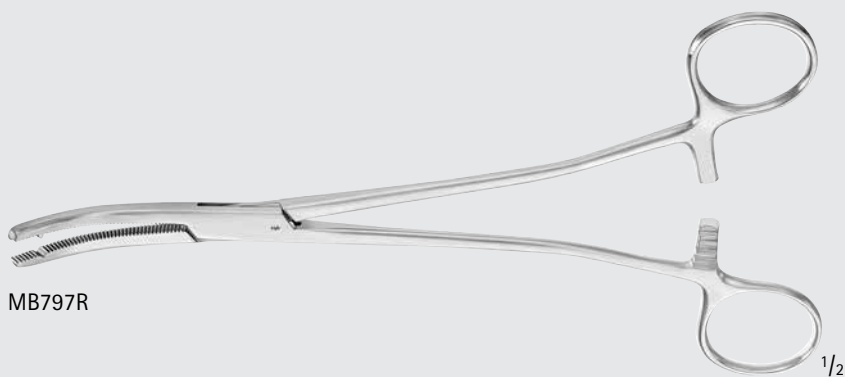

MB797R

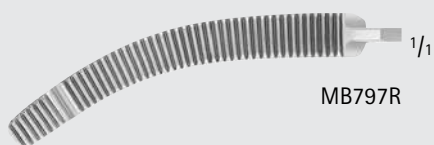

MB797R

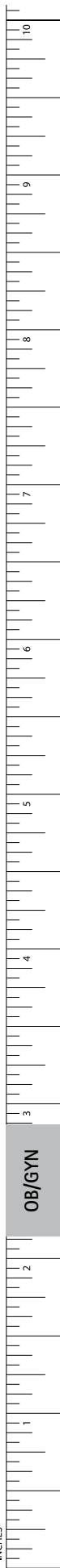

Obstetrics/Gynecology

Clamps

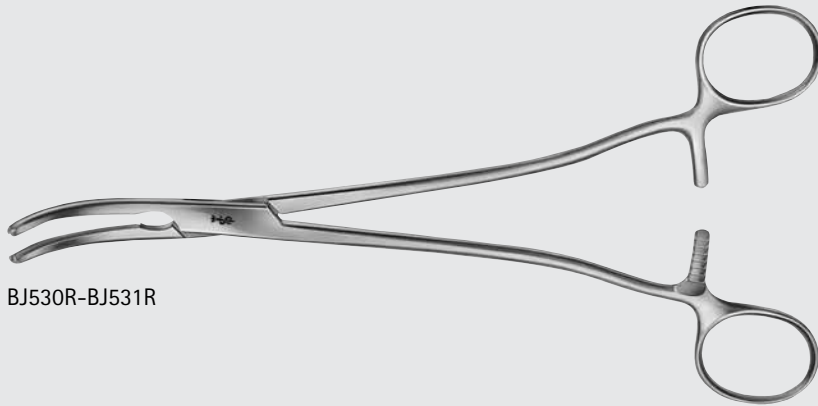

BJ530R-BJ531R

HEANEY Hysterectomy Forceps, W/O Teeth

Catalog Number	Jaw	Length (in.)
BJ530R	STR	8 7/8
BJ532R	CVD	8 1/2
BJ531R	CVD	8 3/4



BJ530R

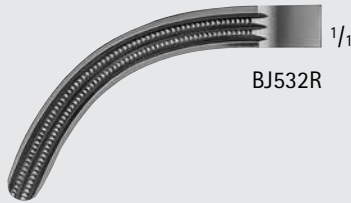

BJ532R



BJ531R

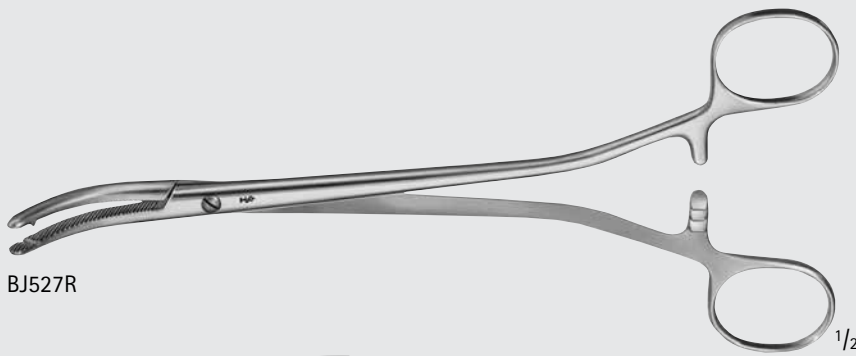

BJ527R

WIENER Hysterectomy Forceps, W/ Grooves

Catalog Number	Tip	Jaw	Length (in.)
BJ527R	SMOOTH	CVD	9 1/2

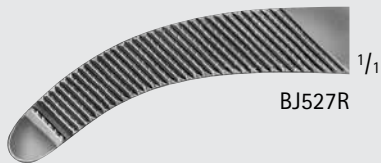

BJ527R

OB/GYN

WERTHEIM Atraumatic Parametrium Clamp

Catalog Number	Jaw	Length (in.)
BJ550R	STR	9 3/4
BJ551R	SLT-CVD	9 5/8
BJ552R	CVD	9 1/2
BJ553R	UP-CVD	8 3/4

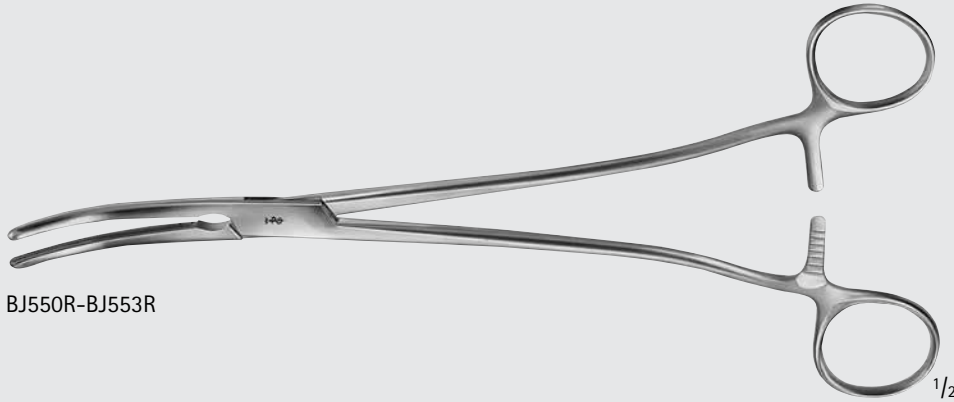

BJ550R-BJ553R



BJ550R

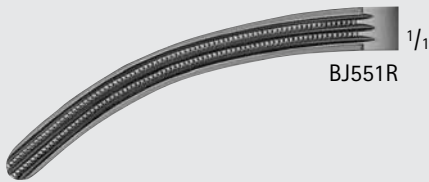

BJ551R



BJ552R

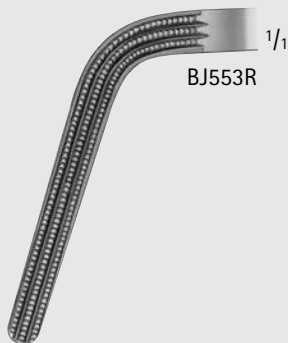

BJ553R

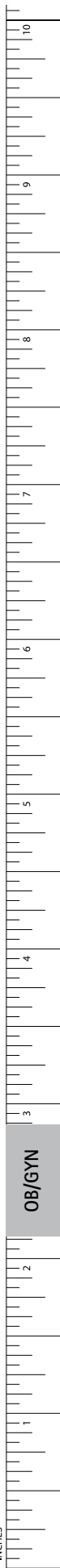

Obstetrics/Gynecology

Clamps

WERTHEIM Parametrium Clamp

Catalog Number	Jaw	Length (in.)
BJ576R	CVD	10 1/4

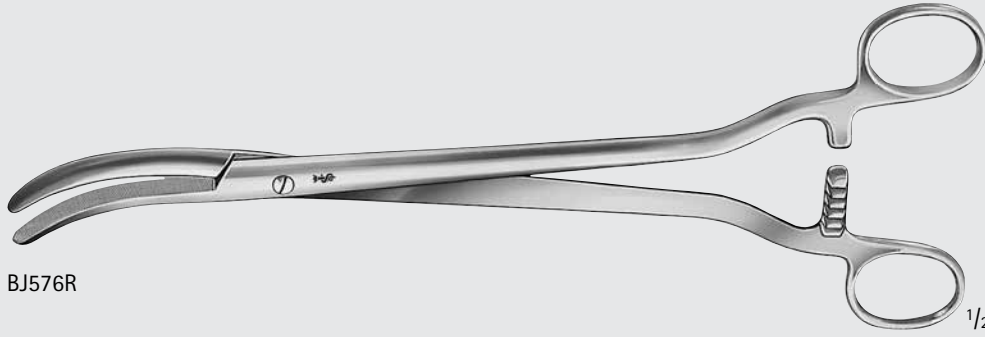

BJ576R

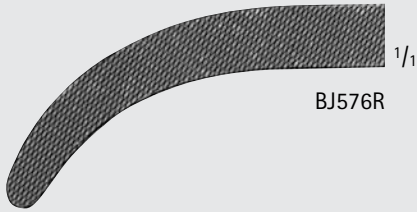

BJ576R

WERTHEIM Hysterectomy Forceps

Catalog Number	Jaw	Length (in.)
BJ574R	CVD	10

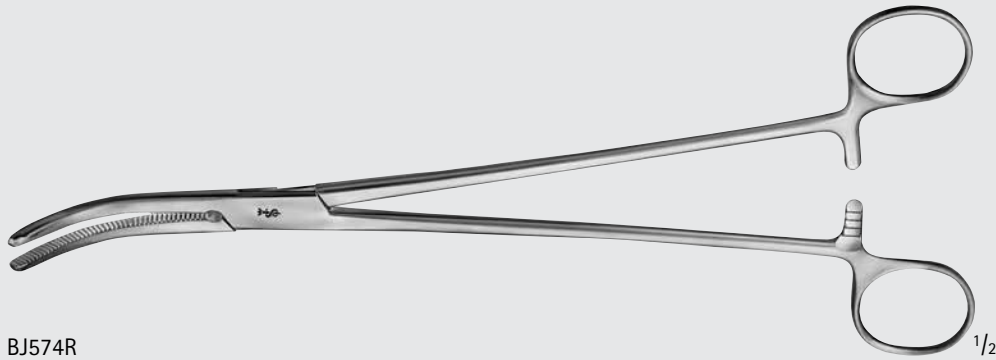

BJ574R



BJ574R

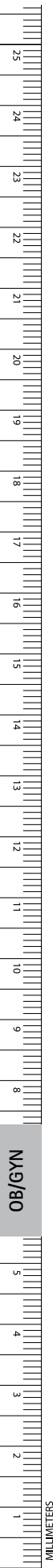

WERTHEIM-CULLEN Clamp

Catalog Number	Jaw	Length (in.)
BJ579R	RIGHT-ANG	8 1/2

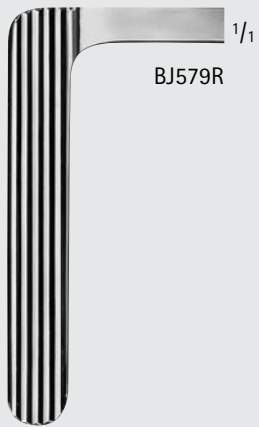
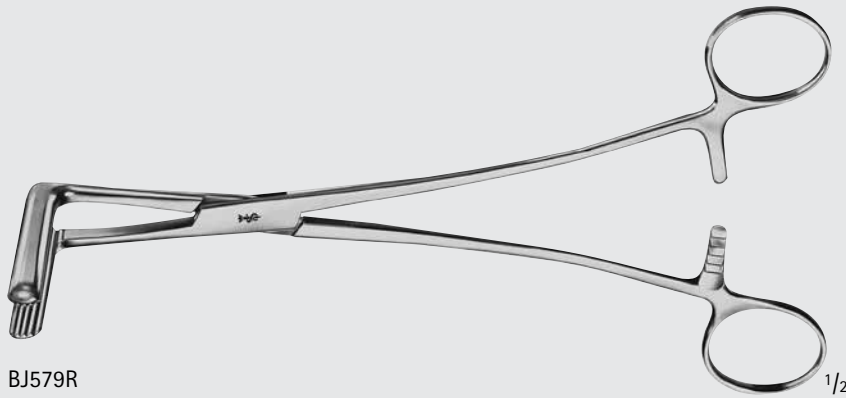

WERTHEIM Atraumatic Clamp

Catalog Number	Jaw	Length (in.)
BJ581R	RIGHT-ANG	9 3/4

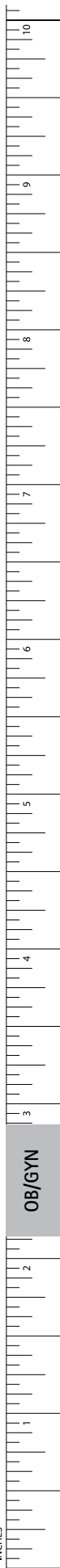
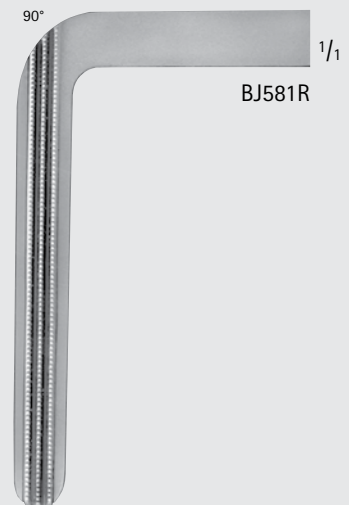
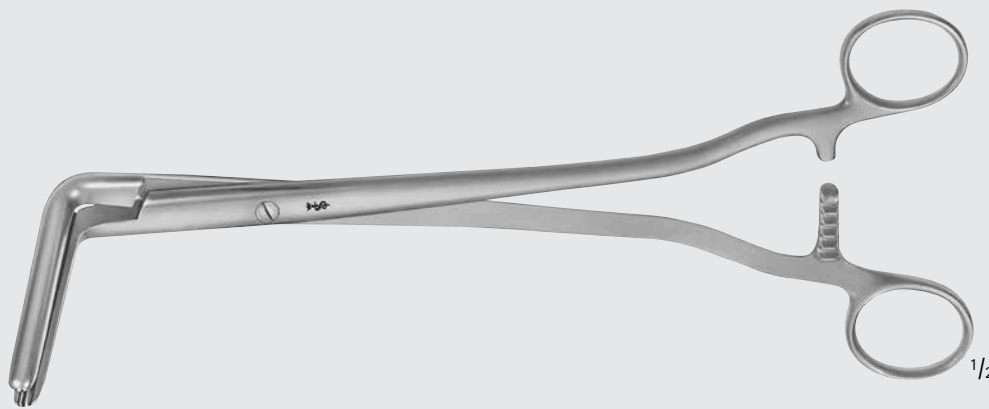

INCHES

OB/GYN

Obstetrics/Gynecology

Clamps

GLASSMAN Anterior Resection Clamp

Catalog Number	Jaw	Jaw Length (mm)	Length (in.)
MB931R	90°, SERR	25	9 3/4
MB130R	90°, SERR	50	9 3/4
MB932R	90°, SERR	75	10

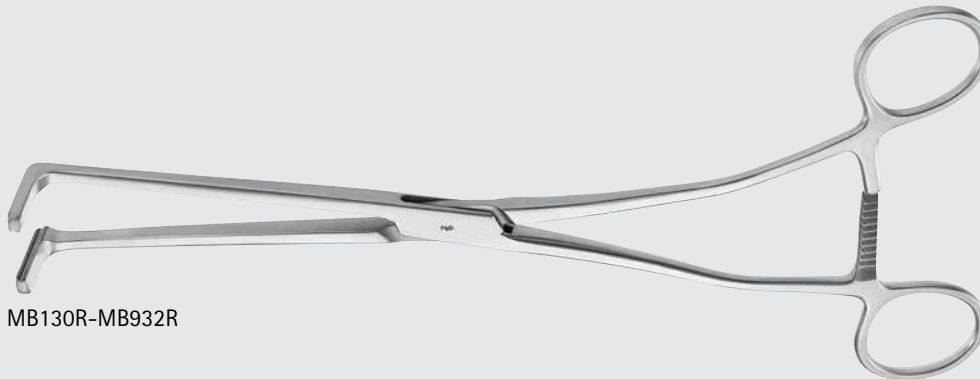

MB130R-MB932R

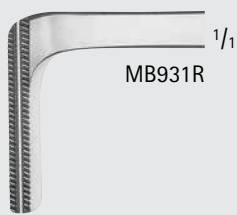

MB931R

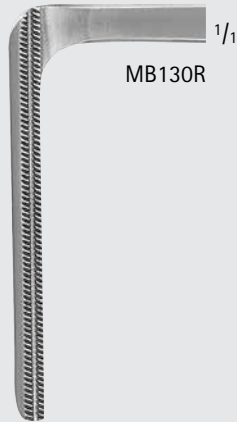

MB130R

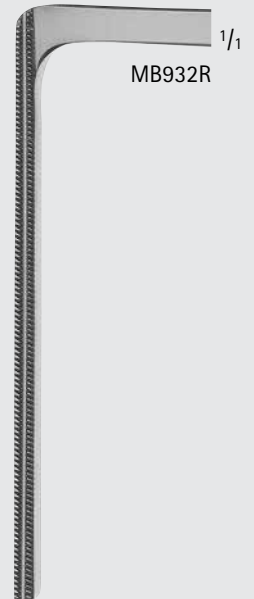

MB932R

MASTERSON Uterine Clamp

Catalog Number	Jaw	Length (in.)
MG198R	STR	8 1/2
MG199R	CVD	8 1/2

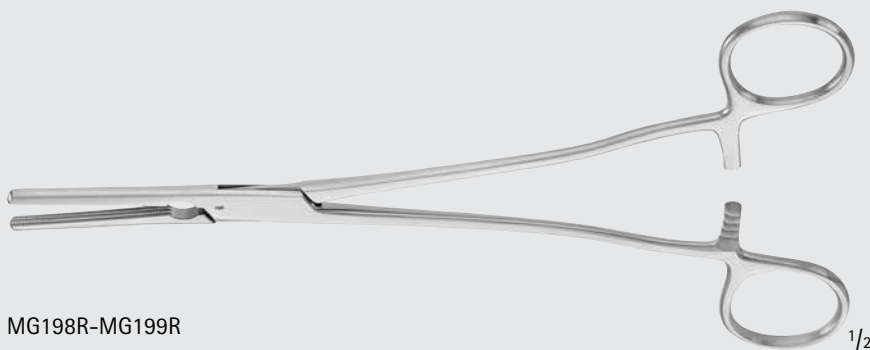

MG198R-MG199R



MG198R



MG199R

OB/GYN

Z-Type Hysterectomy Clamp

Catalog Number	Jaw	Handle	Length (in.)
MG203R	STR	STR	8 1/2
MG204R	SLIGHT-CVD	STR	8 1/2
MG205R	CVD	STR	8 1/2
MG206R	ANG	STR	8 1/2
MB352R	STR	STR	9 1/2
MB353R	SLIGHT-CVD	STR	9 1/2
MB354R	CVD	STR	9 1/2
MB355R	ANG	STR	9 1/2
MB786R	STR	ANG	9 1/2
MB787R	SLIGHT-CVD	ANG	9 1/2
MB788R	CVD	ANG	9 1/2
MB789R	ANG	ANG	9 1/2
MB187R	STR	STR	12
MB188R	SLIGHT-CVD	STR	12
MB183R	CVD	STR	12
MB184R	ANG	STR	12
MB790R	STR	ANG	12
MB792R	SLIGHT-CVD	ANG	12
MB793R	CVD	ANG	12
MB794R	ANG	ANG	12



MG203R-MB206R, MB352R-MB355R, MB183R-MB188R



MB786R-MB789R, MB790R-MB794R

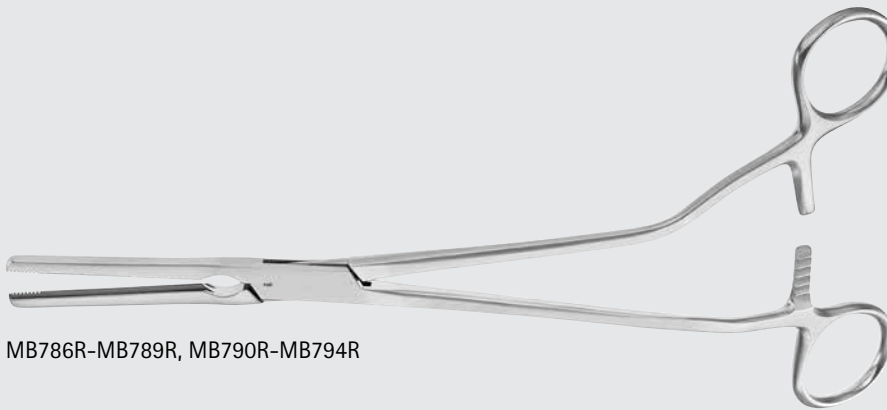

MG203R, MB352R, MB786R, MB187R, MB790R

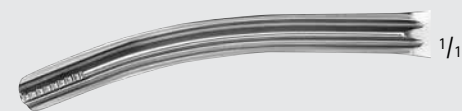

MG204R, MB353R, MB787R, MB188R, MB792R



MG205R, MB354R, MB788R, MB183R, MB793R



MG206R, MB355R, MB789R, MB184R, MB794R



Obstetrics/Gynecology

Clamps

Z-Type Hysterectomy Clamp (continued)

Catalog Number	Jaw	Handle	Length (in.)
MB185R	STR	STR	14
MB186R	SLT-CVD	STR	14
MB987R	CVD	STR	14
MB988R	ANG	STR	14

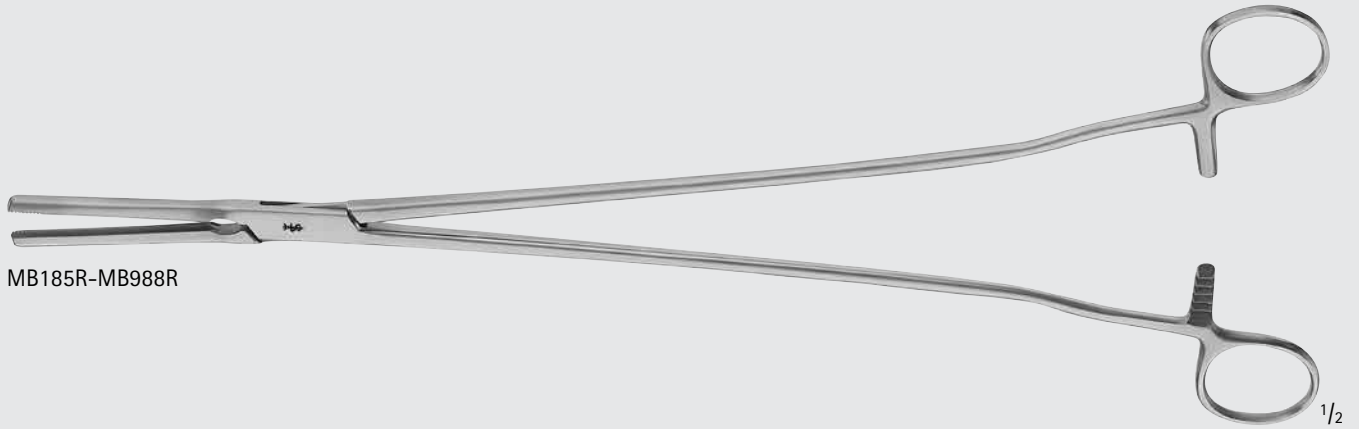

MB185R-MB988R



MB185R 1/1



MB186R 1/1



MB987R 1/1

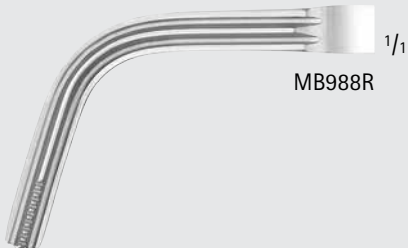

MB988R 1/1

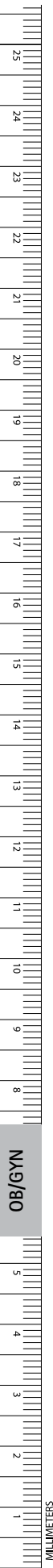

Obstetrics/Gynecology

Perineal and Vaginal Retractors

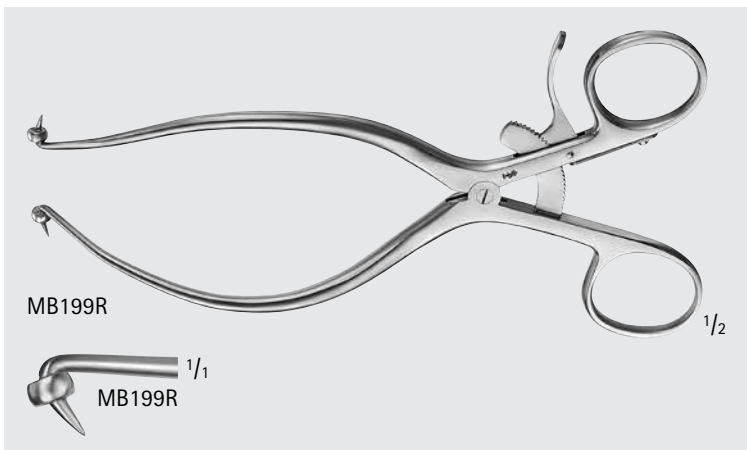

GELPI Perineal Retractor W/ Ball Stop

Catalog Number	Length (in.)
MB199R	7

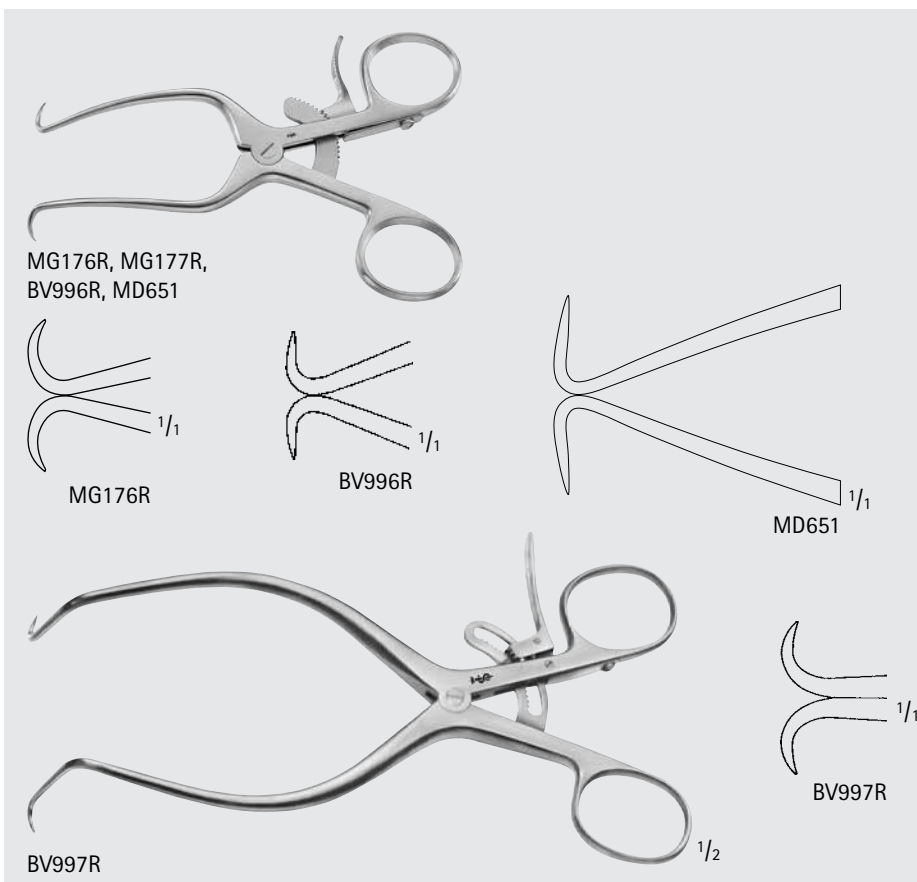

GELPI Vaginal Retractor

Catalog Number	Tip	Length (in.)
MG176R	SHARP	3 1/2
BV996R	SHARP	5 1/4
BV997R	SHARP	6 7/8
MD651	SHARP	7 1/4
MG177R	BLUNT	4 1/2



RIGBY Vaginal Retractor

Catalog Number	Length (in.)
MB267R	7 1/2

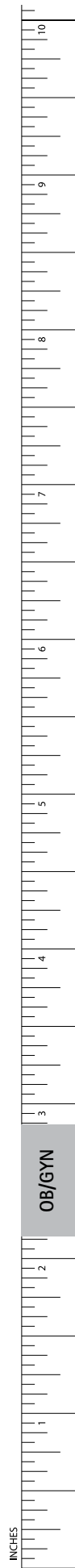

Obstetrics/Gynecology

Retractors



MB068R

DELEE Universal Retractor

Catalog Number	Length (in.)
MB068R	9 1/2



US100-US100202

O' SULLIVAN-O' CONNOR Retractor

Catalog Number	Description	Blade Size (mm)
US100	COMPLETE	185 x 143
US100201	SMALL BLADE	80 x 149
US100202	LARGE BLADE	155 x 110

US100 Includes:

- 1 Retractor US100200
- 2 Blades US100201 and
- 1 Blade US100202



US100201



US100202



OB/GYN

MILLIMETERS

Obstetrics/Gynecology

Vaginal Retractors and Specula

COLLIN Vaginal Specula

Catalog Number	Blade Size (mm)
ELO11R	95/85 x 18



ELO11R

CUSCO Vaginal Specula

Catalog Number	Blade Size (mm)
ELO40R	75 x 17

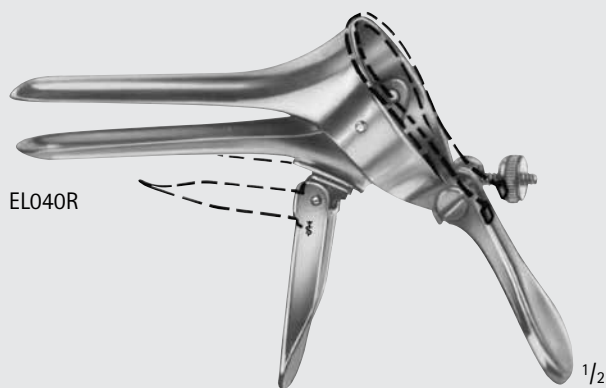

ELO40R

CUSCO Vaginal Specula

Catalog Number	Blade Size (mm)
ELO42R	80 x 32
ELO43R	90 x 36
ELO44R	110 x 37

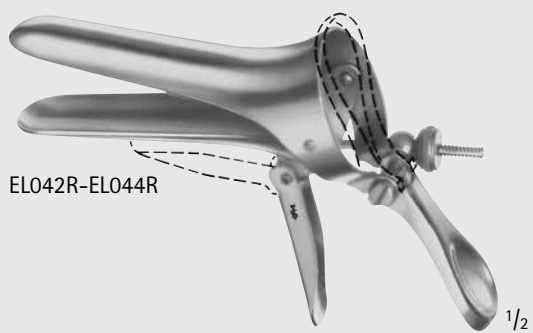

ELO42R-EL044R

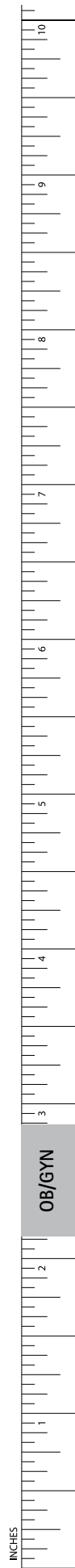

Obstetrics/Gynecology

Vaginal Retractors and Specula

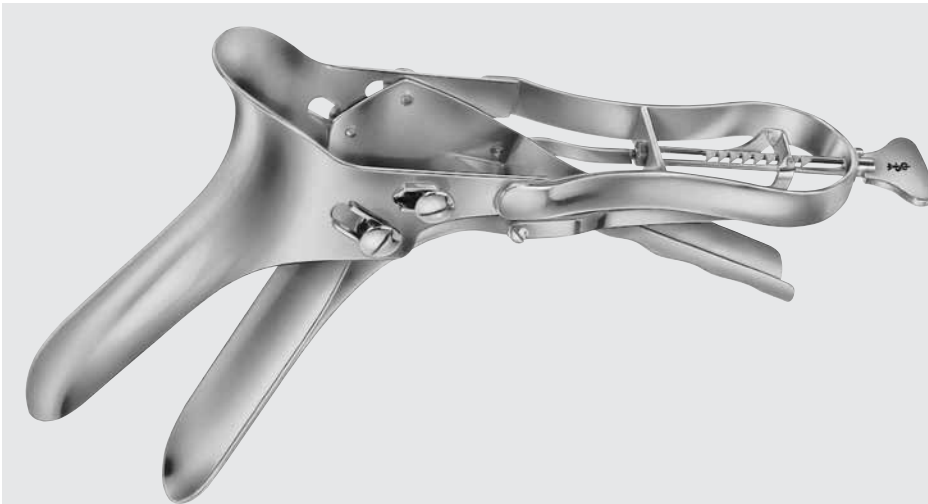
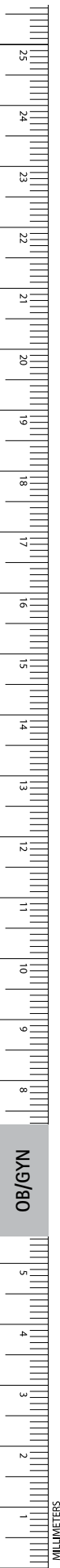

SEYFFERT Vaginal Specula

Catalog Number	Blade Size (mm)	Length (in.)
EL180R	100 x 17	9
EL181R	110 x 33	9

1/2

EL180R-EL181R

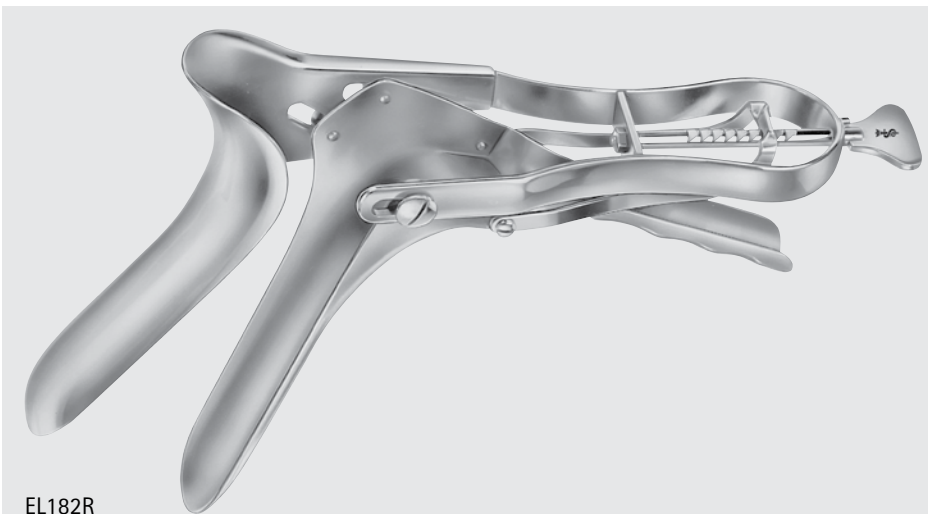

SEYFFERT Speculum, 1 Side Open

Catalog Number	Blade Size (mm)	Length (in.)
EL182R	110 x 33	9

1/2

EL182R



SEMM Vaginal Specula, 45° Angle

Catalog Number	Blade Size (mm)	Length (in.)
EL183R	90 x 14	7

1/2

EL183R

Obstetrics/Gynecology

Vaginal Retractors and Specula

PEDERSON Vaginal Speculum

Catalog Number	Blade Size (mm)
MB066R	75 x 12.7
EL192R	100 x 22
MG156R	115 x 16
EL193R	120 x 25



MB066R-EL193R

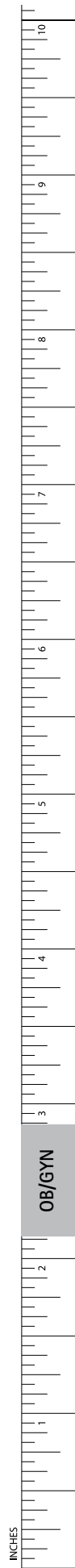

Obstetrics/Gynecology

Vaginal Retractors and Specula



MB067R

PEDERSON Vaginal Speculum, Large, Insulated Coating, W/ Evacuation Vent

Catalog Number	Blade Size (mm)
MB067R	120 x 25



EL194R-MG159R

GRAVES Vaginal Speculum

Catalog Number	Blade Size (mm)
EL194R	75 x 20
EL195R	95 x 30
EL196R	105 x 33
MG159R	125 x 40
MB841R	102 x 34 W/ SIDE OPENING

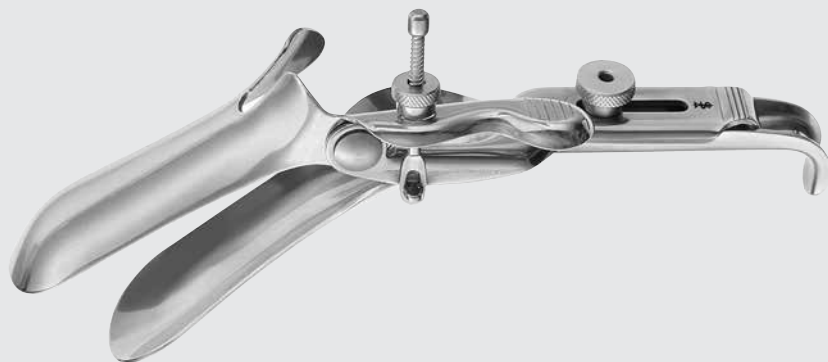

MB841R

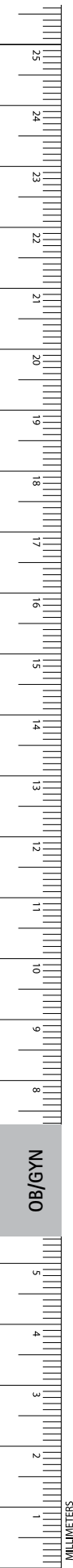

Obstetrics/Gynecology

Vaginal Retractors and Specula

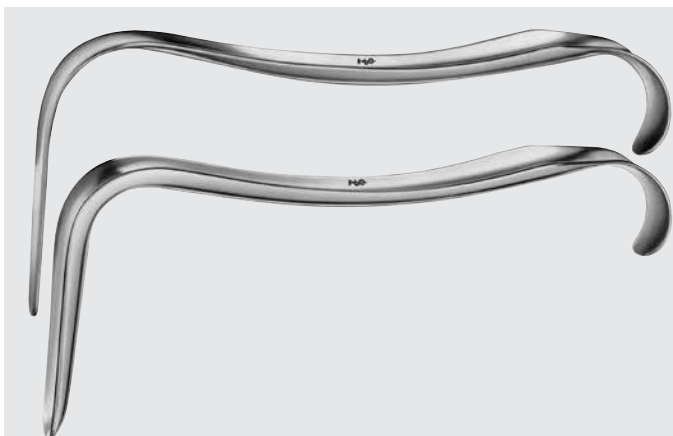

EL420R-EL428R

KRISTELLER Vaginal Speculum, Set of 2 each

Catalog Number	Blade Size (mm)	Length (in.)
EL420R	70 x 15	6 3/4
EL421R	70 x 27	6 7/8
EL422R	75 x 30	6 7/8
EL423R	90 x 36	6 7/8
EL426R	110 x 20	8 3/4
EL425R	110 x 27	8 3/4
EL427R	110 x 30	8 3/4
EL428R	110 x 36	8 3/4

Each blade size comes as a set of 2 - with one upper and one lower blade

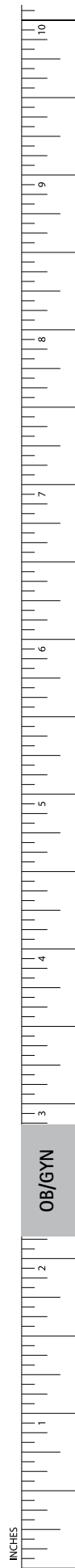

Obstetrics/Gynecology

Vaginal Retractors and Specula



EL450R-EL458R

KRISTELLER Vaginal Specula Upper Blades

Catalog Number	Blade Size (mm)	Length (in.)
EL450R	75 x 10	6 7/8
EL451R	75 x 23	7
EL452R	80 x 25	7
EL453R	100 x 32	7 1/4
EL454R	115 x 14	8 1/2
EL455R	115 x 23	8 1/2
EL457R	115 x 26	8 3/4
EL458R	120 x 30	8 7/8



EL450R



EL451R



EL452R



EL453R



EL454R



EL455R



EL457R



EL458R



Obstetrics/Gynecology

Vaginal Retractors and Specula

KRISTELLER Vaginal Specula Lower Blades

Catalog Number	Blade Size (mm)	Length (in.)
EL440R	70 x 15	6 7/8
EL441R	70 x 27	7
EL442R	75 x 30	7
EL443R	90 x 36	7 1/4
EL444R	110 x 18	8 1/2
EL445R	110 x 27	8 1/2
EL446R	110 x 20	8 3/4
EL447R	110 x 30	8 3/4
EL448R	110 x 36	8 7/8



EL440R-EL448R



EL440R



EL441R



EL442R



EL443R



EL444R



EL445R



EL446R



EL447R



EL448R

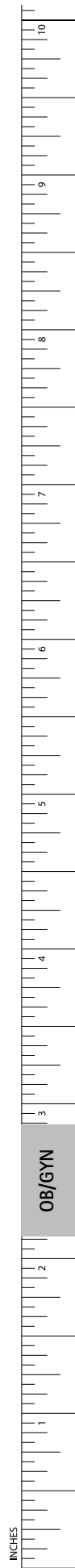

Obstetrics/Gynecology

Vaginal Retractors and Specula

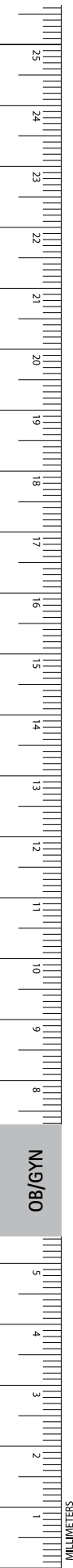

KALLMORGEN Vaginal Specula Set of 2

Catalog Number	Blade Size (mm)	Length (in.)
EL480R	75 x 39	6 3/4

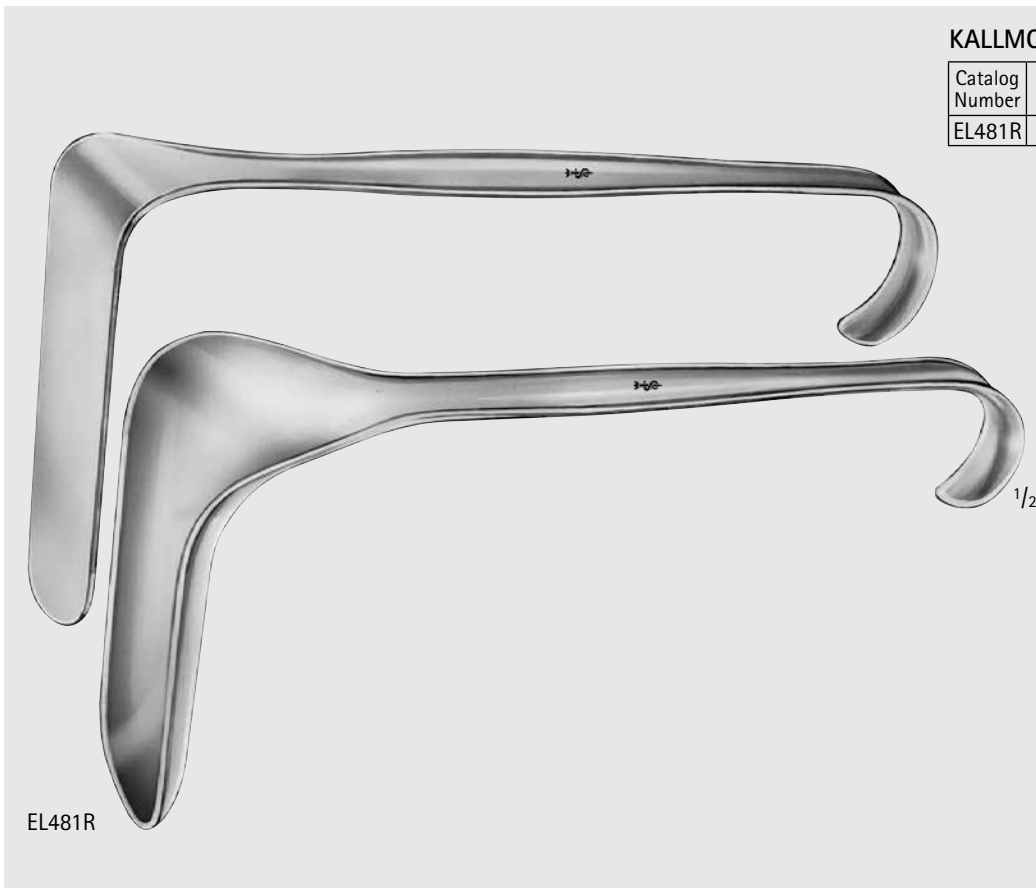

KALLMORGEN Vaginal Specula Set of 2

Catalog Number	Blade Size (mm)	Length (in.)
EL481R	95 x 39	7 7/8

Obstetrics/Gynecology

Vaginal Retractors and Specula



MB759R-MB761R

SIMS Vaginal Retractor

Catalog Number	Blade Size (mm)
MB759R	70 x 25
MB760R	76 x 32
MB761R	89 x 38



MG158R-EL409R

SIMS Vaginal Speculum, Double Ended

Catalog Number	Blade Size (mm)	Length (in.)
MG158R	69 x 25 / 70 x 30	5
EL407R	70 x 26 / 75 x 30	5
EL408R	75 x 30 / 80 x 35	6
EL409R	80 x 36 / 90 x 40	6 7/8

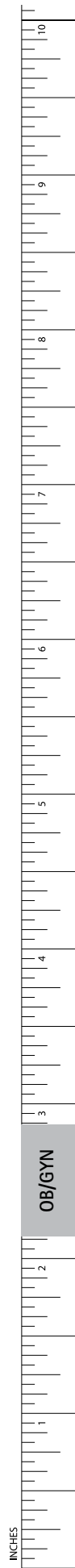

Obstetrics/Gynecology

Vaginal Retractors and Specula

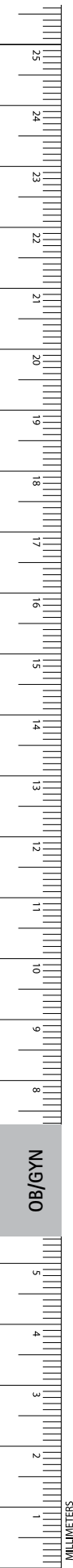

EL578R-EL579R

JACKSON Vaginal Speculum Lower Blade

Catalog Number	Blade	Blade Size (mm)	Length (in.)
EL578R	SLIGHT-CONCAVE	89 x 38	6 7/8
EL579R	SLIGHT-CONCAVE	102 x 38	6 7/8



EL578R



EL579R



EL581R, MB764R-MB765R

EASTMAN Vaginal Retractor

Catalog Number	Blade Size (mm)	Length (in.)
MB764R	75 x 40	6 7/8
EL581R	89 x 38	6 7/8
MB765R	100 x 40	6 7/8

Obstetrics/Gynecology

Vaginal Retractors and Specula

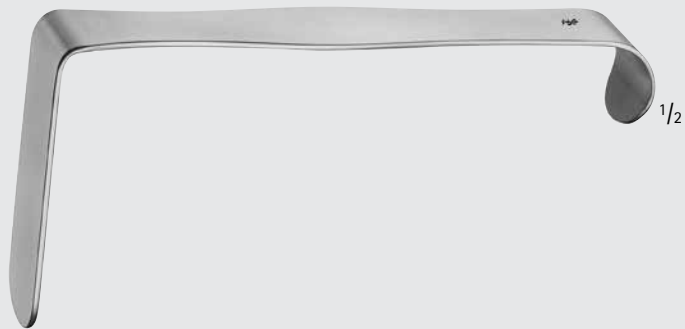

EL865R

HEANEY Retractor

Catalog Number	Blade Size (mm)	Length (in.)
MB762R	45 x 25	6 3/4
MB763R	73 x 29	6 3/4
EL865R	83 x 29	6 3/4



MB762R-MB763R



EL627R-EL629R

DOYEN Vaginal Speculum

Catalog Number	Blade Size (mm)	Length (in.)
EL627R	60 x 45	9 1/4
EL628R	90 x 45	9 1/4
EL629R	112 x 45	9 1/4

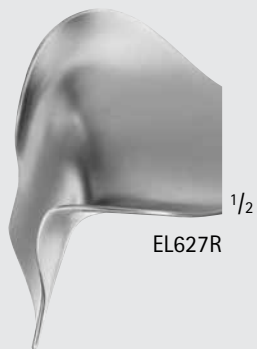

EL627R



EL628R



EL629R

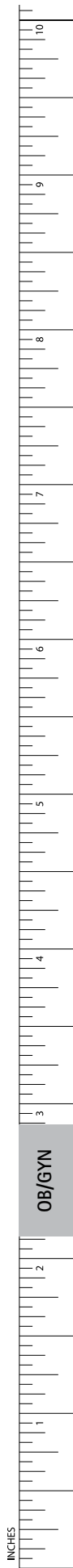

Obstetrics/Gynecology

Vaginal Retractors and Specula

DOYEN Vaginal Speculum

Catalog Number	Blade Size (mm)	Length (in.)
EL631R	60 x 35	9 1/2
EL632R	90 x 35	9 1/2
EL633R	120 x 35	9 1/2
EL634R	60 x 45	9 1/2
EL635R	90 x 45	9 1/2
EL636R	120 x 45	9 1/2
EL637R	60 x 60	9 1/2
EL638R	90 x 60	9 1/2
EL639R	120 x 60	9 1/2
EL642R	160 x 45	9 1/2
EL644R	160 x 60	9 1/2

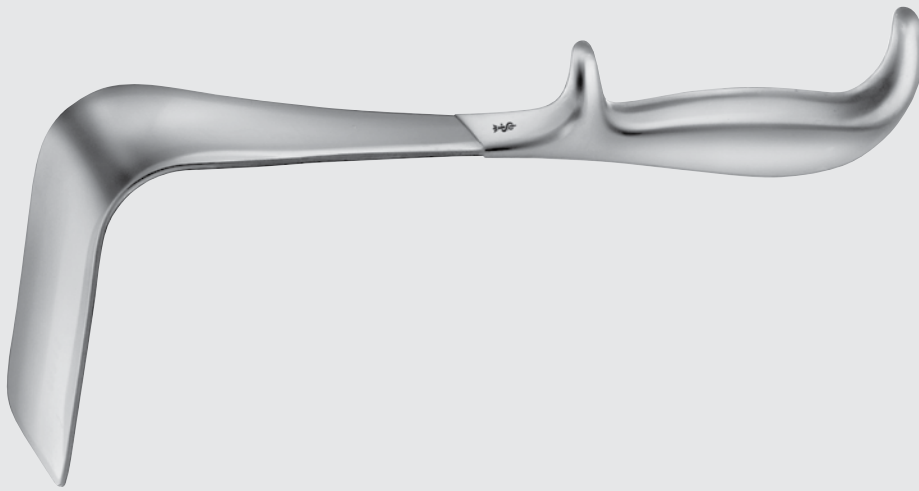

EL631R-EL644R

BREISKY Vaginal Speculum

Catalog Number	Blade Size (mm)	Length (in.)
EL703R	100 x 20	11 3/4
EL704R	100 x 25	11 3/4
EL705R	100 x 30	11 3/4
EL707R	100 x 35	11 3/4
EL708R	100 x 40	11 3/4
EL693R	130 x 20	12 1/2
EL694R	130 x 25	12 1/2
EL695R	130 x 30	12 1/2
EL697R	130 x 35	12 1/2
EL698R	130 x 40	12 1/2
EL700R	160 x 40	13 3/4
EL702R	180 x 40	13 3/4



EL700R-EL708R, EL693R-EL698R



OB/GYN

Obstetrics/Gynecology

Vaginal Retractors and Specula

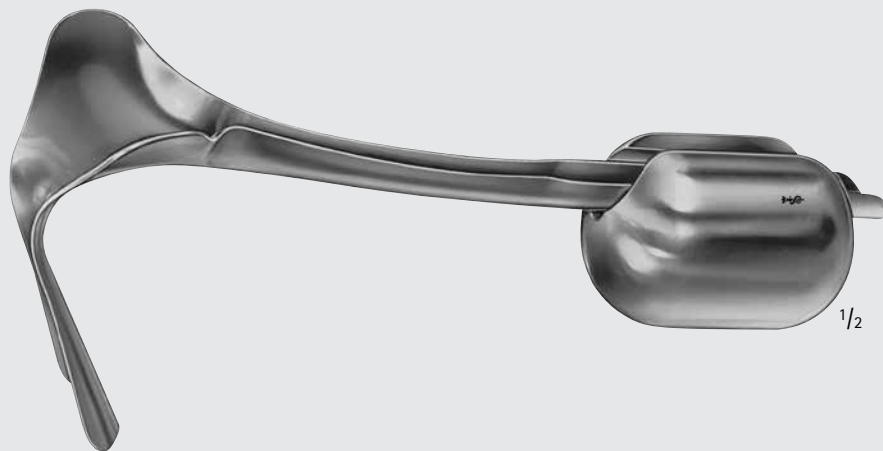

EL736R

AUVARD Speculum, W/ Detachable Weight

Catalog Number	Blade Size (mm)	Length (in.)
EL736R	65 x 38-28	9

Weight:
 Speculum, only: 0.3 lbs.
 Weight, only: 1.7 lbs.

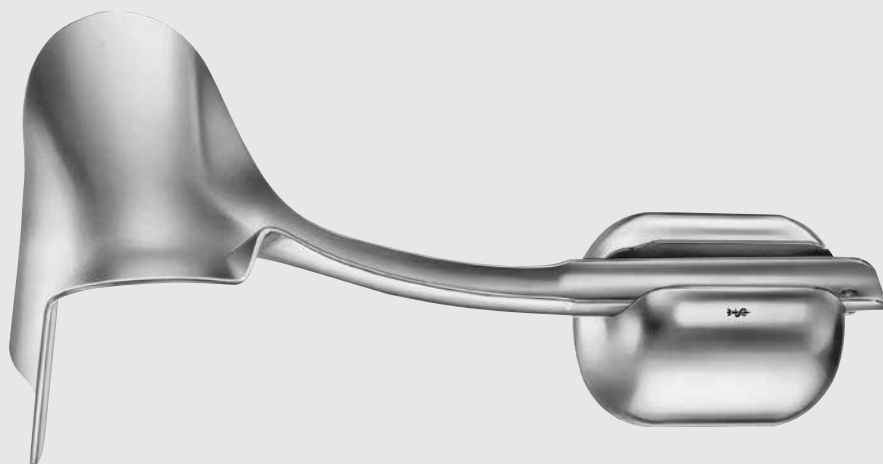

EL738R-EL739R

AUVARD Speculum, W/ Detachable Weight

Catalog Number	Blade Size (mm)	Length (in.)
EL738R	75 x 42-40	9
EL739R	105 x 43-40	9

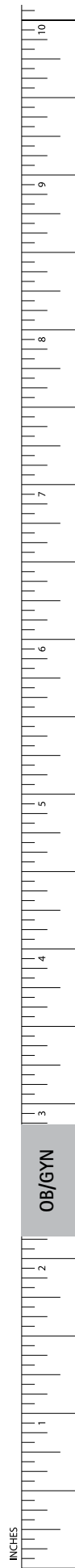

OB/GYN

Obstetrics/Gynecology

Vaginal Retractors and Specula

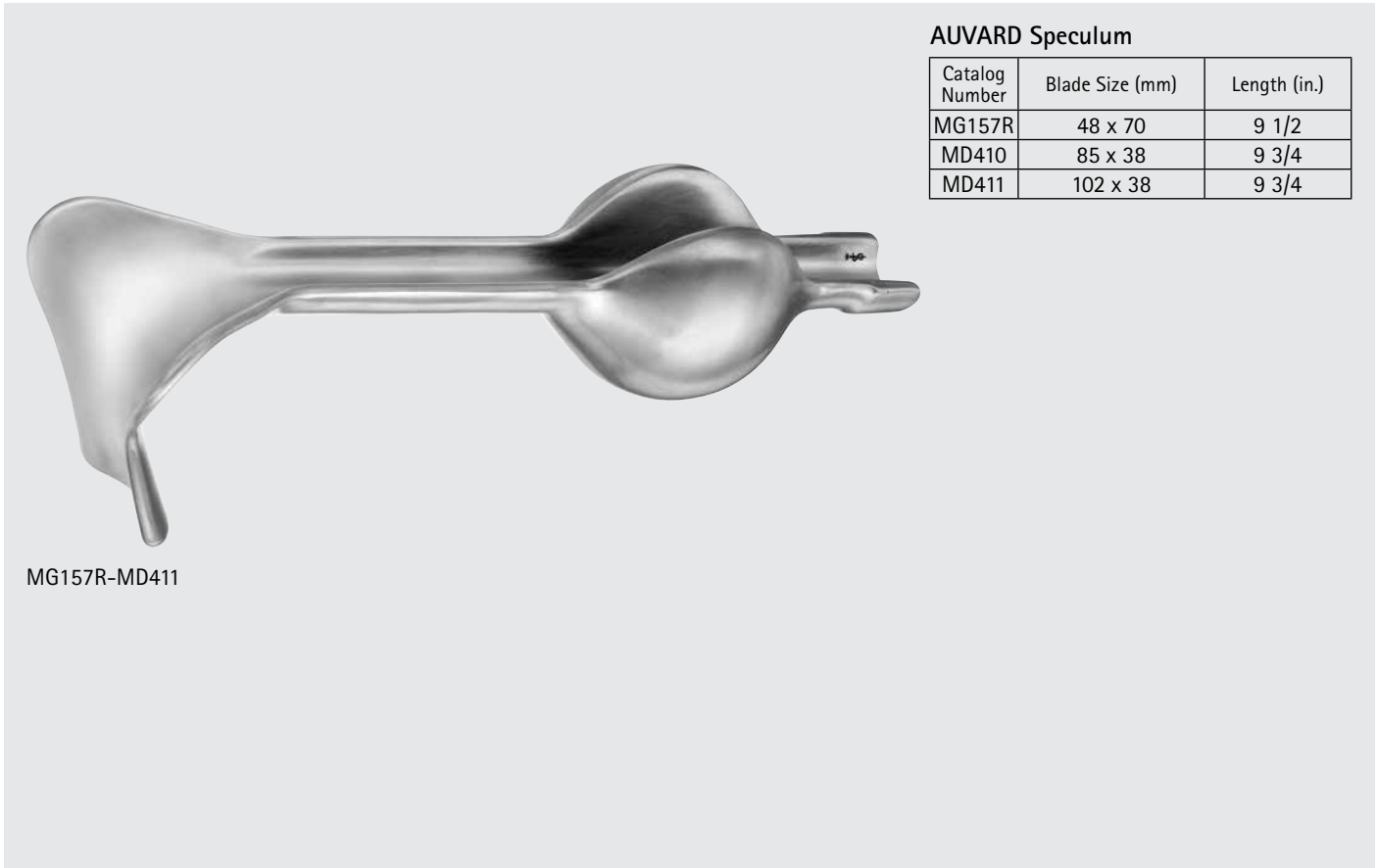
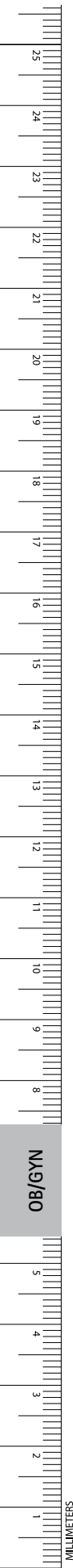

AUVARD Speculum

Catalog Number	Blade Size (mm)	Length (in.)
MG157R	48 x 70	9 1/2
MD410	85 x 38	9 3/4
MD411	102 x 38	9 3/4

MG157R-MD411

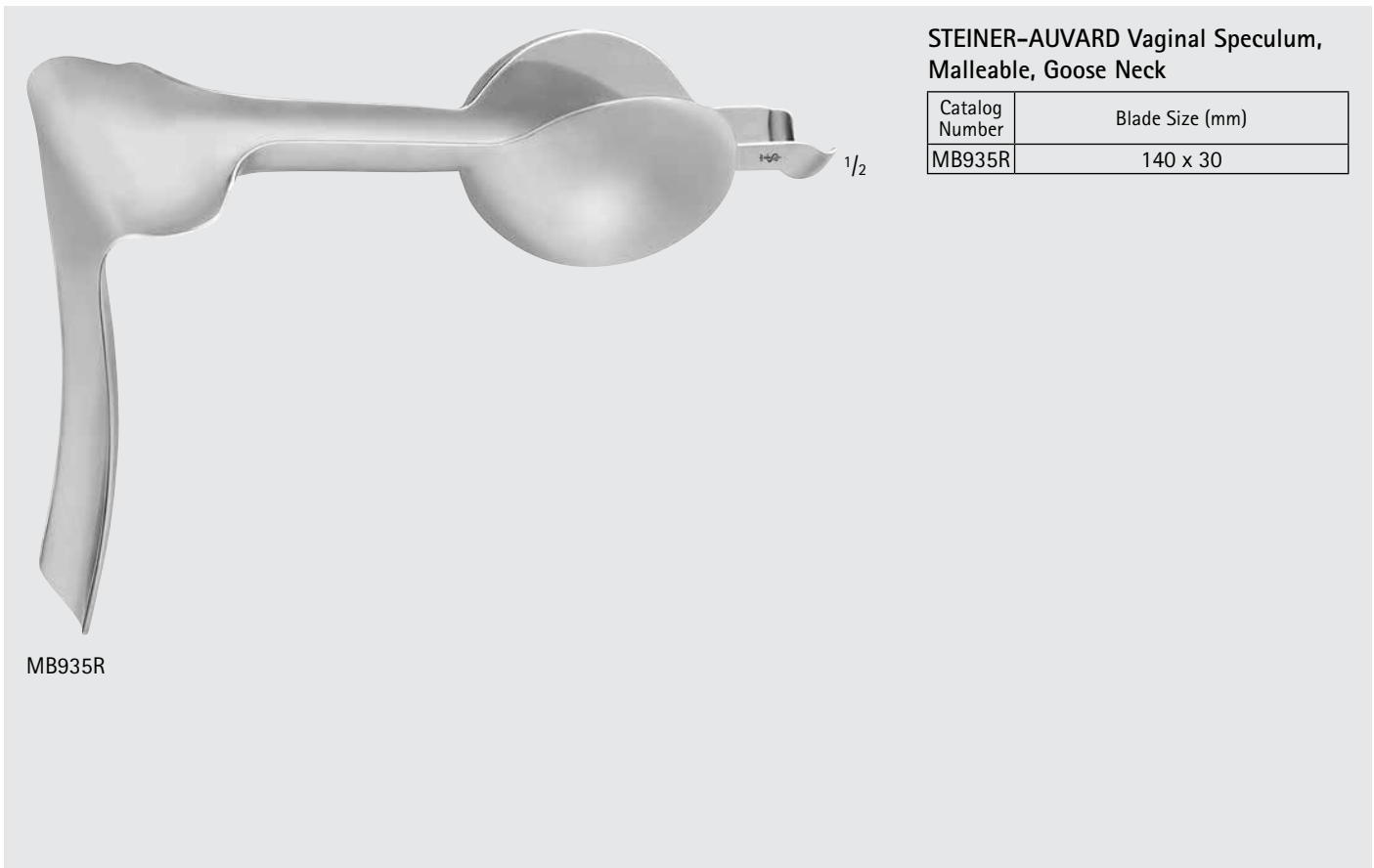

STEINER-AUVARD Vaginal Speculum, Malleable, Goose Neck

Catalog Number	Blade Size (mm)
MB935R	140 x 30

MB935R

Obstetrics/Gynecology

Vaginal Retractors and Specula

DOYEN Lateral Speculum

Catalog Number	Blade Size (mm)	Length (in.)
EL859R	60 x 30	9
EL860R	80 x 30	9 3/4



EL859R-EL860R

SCHERBACK Vaginal Speculum Set

Catalog Number	Description	Blade Size (mm)
EL740R	SET COMPLETE	-
EL741R	BLADE	80 x 30
EL742R	BLADE	85 x 35
EL743R	BLADE	85 x 40
EL744R	BLADE	55 x 40
EL745R	BLADE	70 x 45
EL746R	HANDLE	-
EL747R	WEIGHT	-

EL740R Includes:
 1 Handle EL746R
 1 Weight EL747R
 4 Blades of each
 EL741R-EL744R

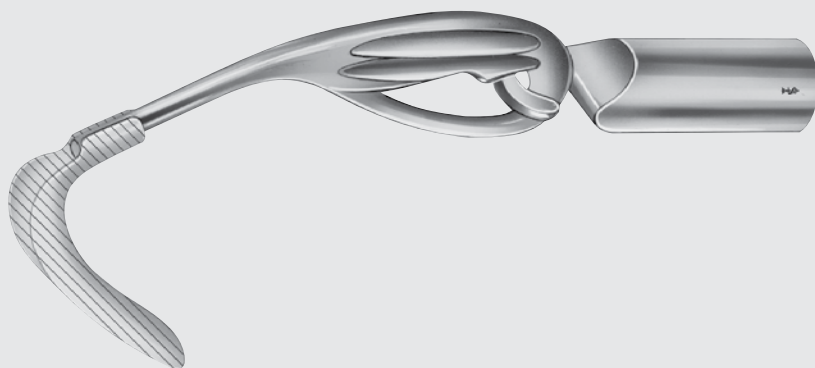

EL740R-EL747R



EL741R



EL742R



EL743R

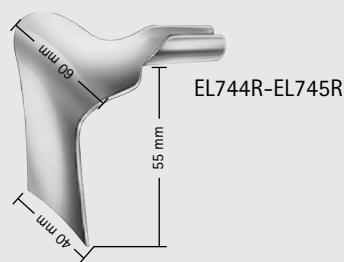

EL744R-EL745R

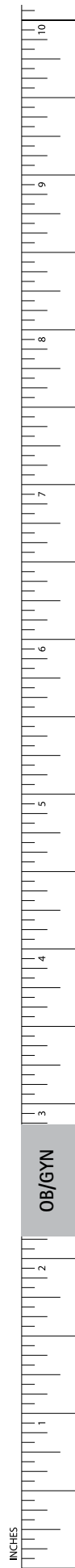

INCHES

OB/GYN

Obstetrics/Gynecology

Vaginal Retractors and Specula

TUEBINGER Vaginal Retractor

Catalog Number	Blade Size (mm)	Length (in.)
EL868R	95 x 20	10 1/2

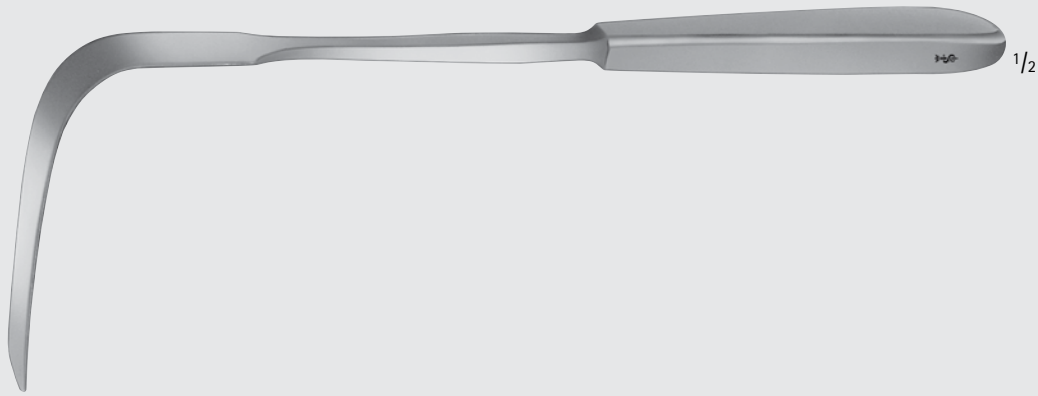

EL868R

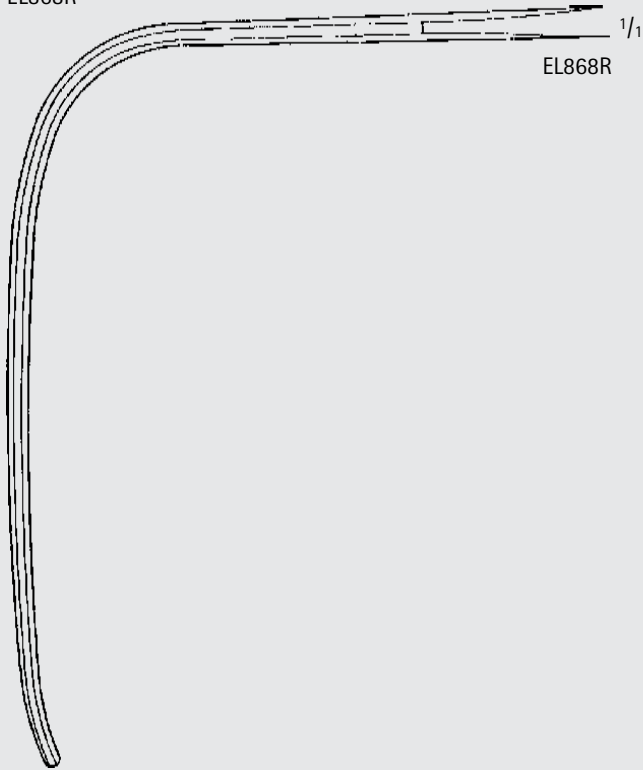

EL868R

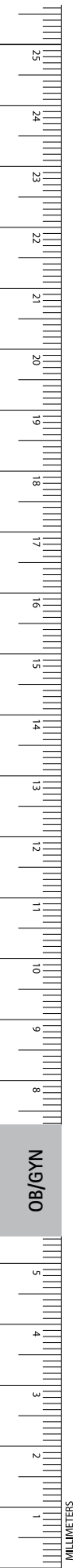

Obstetrics/Gynecology
Vaginal Retractors and Specula

GLENNER Retractor

Catalog Number	Blade Size (mm)	Length (in.)
MG175R	135 x 25	10 5/8



MG175R

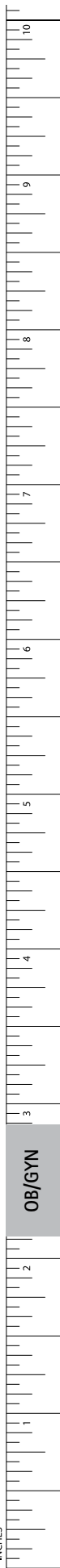

Obstetrics/Gynecology

Vaginal Retractors and Specula

MARTIN Vaginal Retractor

Catalog Number	Blade Size (mm)	Length (in.)
EL870R	105 x 27	9 3/4

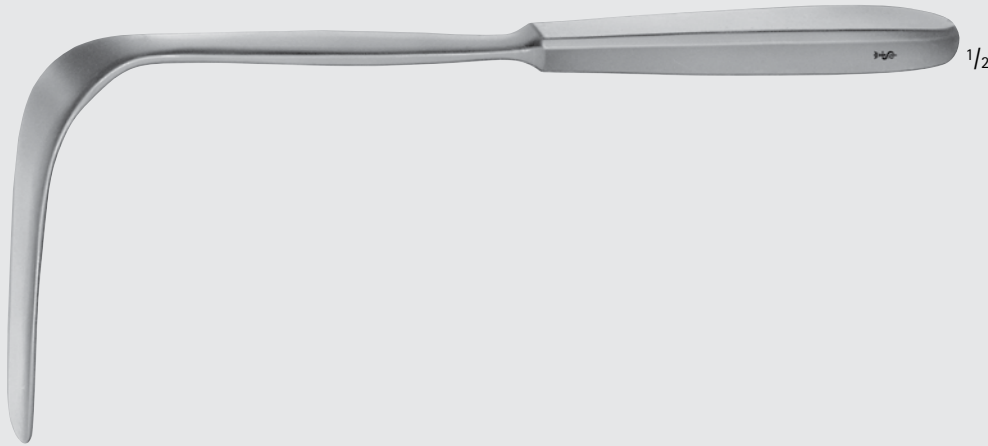

EL870R

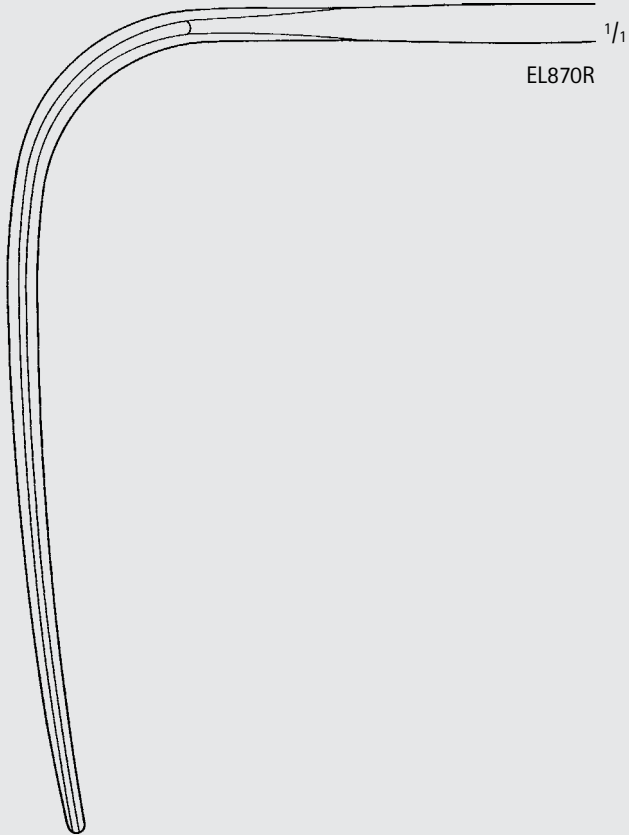

EL870R

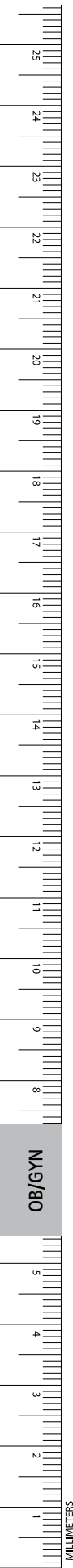

Obstetrics/Gynecology

Vaginal Retractors and Specula

SIMON Vaginal Retractor

Catalog Number	Blade Size (mm)	Length (in.)
EL872R	115 x 22	10 3/4
EL873R	115 x 27	10 3/4

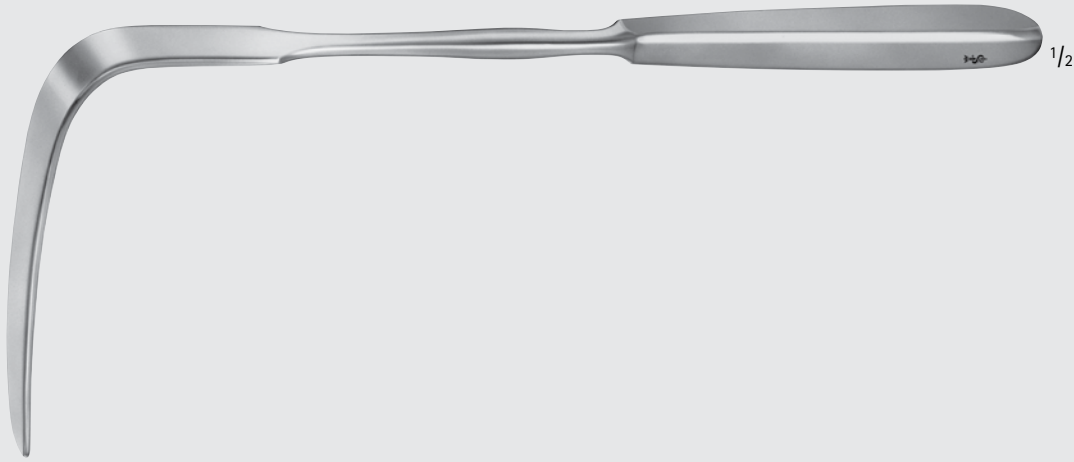

EL872R-EL873R

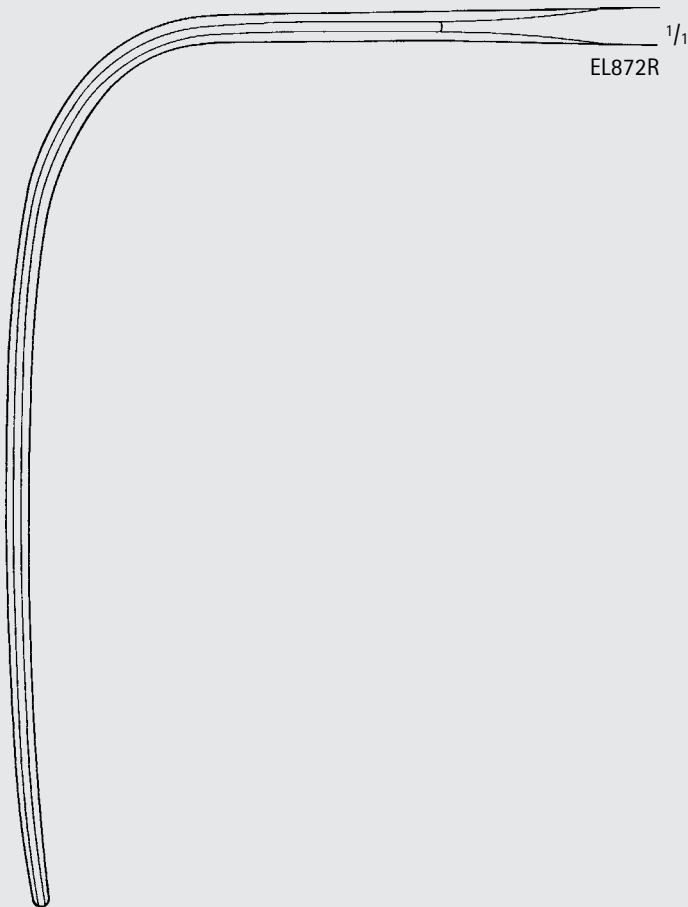

EL872R

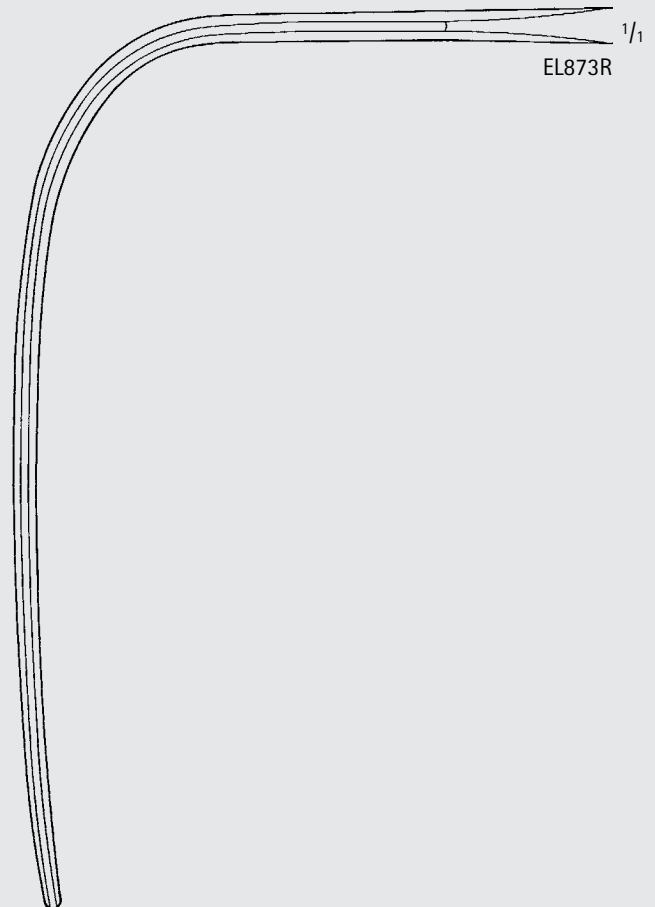

EL873R

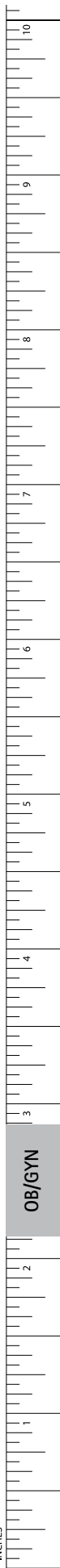

Obstetrics/Gynecology

Endospecula

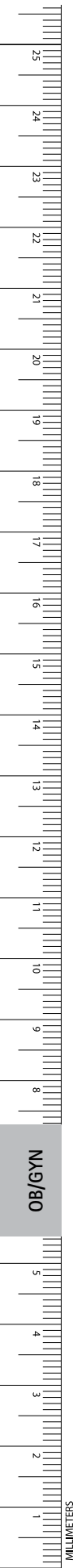

KOGAN Endospeculum

Catalog Number	Length (in.)
EM710R	9 1/2

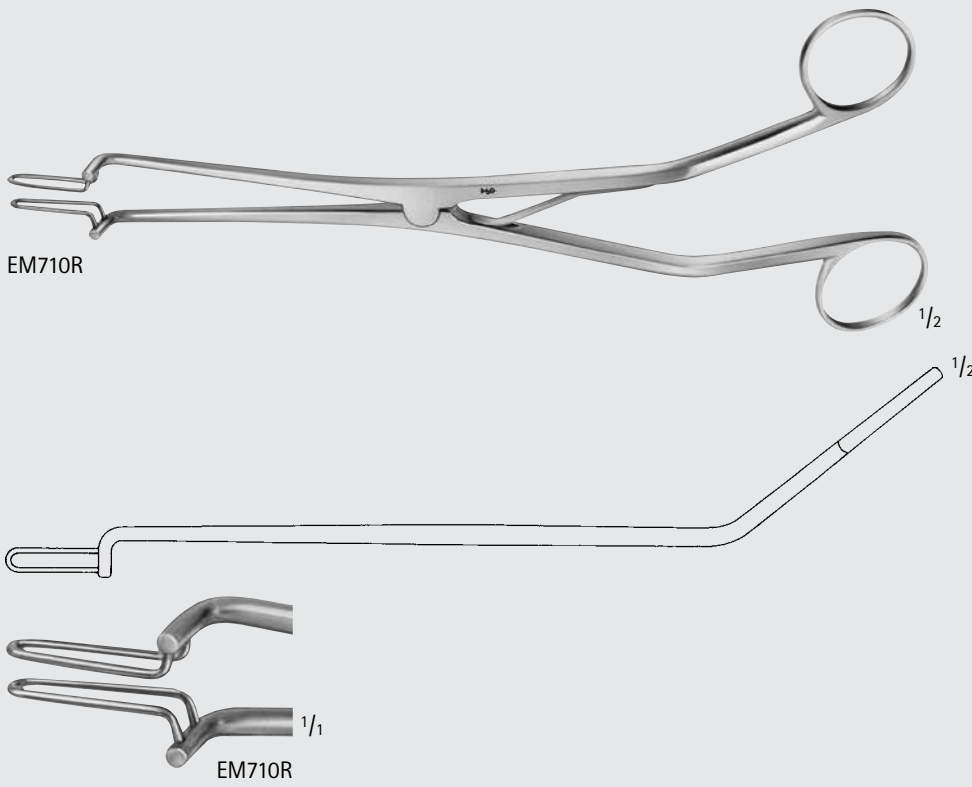

KOGAN Cervix/Urethra Endospeculum, W/ Scale, Ratcheted

Catalog Number	Length (in.)
EM711R	9 1/2

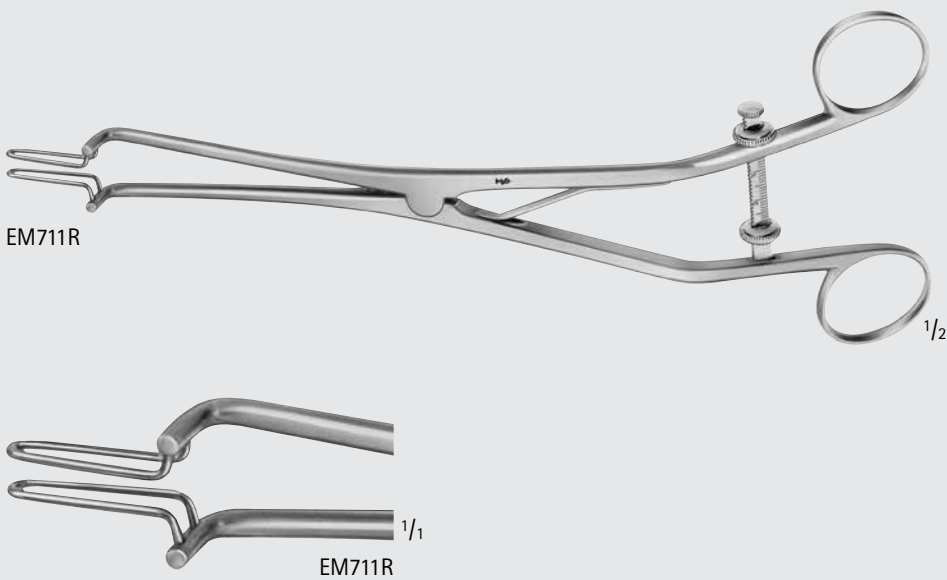



EM101R-EM147R

HEGAR Dilator, Single Ended

Catalog Number	Tip Size (mm)	Length (in.)
EM101R	1	7 1/4
EM102R	2	7 1/4
EM103R	3	7 1/4
EM104R	4	7 1/4
EM105R	5	7 1/4
EM106R	6	7 1/4
EM107R	7	7 1/4
EM108R	8	7 1/4
EM109R	9	7 1/4
EM110R	10	7 1/4
EM111R	11	7 1/4
EM112R	12	7 1/4
EM113R	13	7 1/4
EM114R	14	7 1/4
EM115R	15	7 1/4
EM116R	16	7 1/4
EM117R	17	7 1/4
EM118R	18	7 1/4
EM119R	19	7 1/4
EM120R	20	7 1/4
EM121R	21	7 1/4
EM122R	22	7 1/4
EM123R	23	7 1/4
EM124R	24	7 1/4
EM125R	25	7 1/4
EM126R	26	7 1/4
EM131R	1.5	7 1/4
EM132R	2.5	7 1/4
EM133R	3.5	7 1/4
EM134R	4.5	7 1/4
EM135R	5.5	7 1/4
EM136R	6.5	7 1/4
EM137R	7.5	7 1/4
EM138R	8.5	7 1/4
EM139R	9.5	7 1/4
EM140R	10.5	7 1/4
EM141R	11.5	7 1/4
EM142R	12.5	7 1/4
EM143R	13.5	7 1/4
EM144R	14.5	7 1/4
EM145R	15.5	7 1/4
EM146R	16.5	7 1/4
EM147R	17.5	7 1/4



Obstetrics/Gynecology

Dilators and Probes



EM193R-EM194R

HEGAR Dilator Set, Single Ended

Catalog Number	Item
EM193R	SET W/ 14 DILATORS, 4-17 mm
EM194R	SET W/ 26 DILATORS, 1-26 mm

EM193R Includes:
 EM097R Rack for Dilators 4-12 mm
 EM098R Rack for Dilators 13-17 mm
 JG161R Metal Case: 200 x 100 x 35 mm

Includes Dilators:
 EM104R-EM117R

EM194R Includes:
 EM099R Rack for Dilators 1-17 mm
 EM100R Rack for Dilators 18-26 mm
 JG170R Metal Case: 330 x 220 x 80 mm

Includes Dilators:
 EM101R-EM126R



EM231R-EM244R

HEGAR Uterine Dilator, Double Ended

Catalog Number	Tip Size (mm)	Length (in.)
EM244R	SET OF 8	-
EM231R	1/2	7 3/4
EM232R	3/4	7 3/4
EM233R	5/6	7 3/4
EM234R	7/8	7 3/4
EM235R	9/10	7 3/4
EM236R	11/12	7 3/4
EM237R	13/14	7 3/4
EM238R	15/16	7 3/4
EM239R	17/18	7 3/4

Set Includes:
 EM232R-EM239R

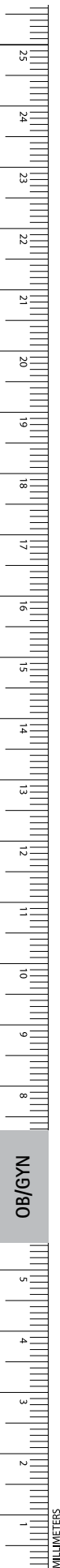

HEGAR Uterine Dilator, Slight Curved, Double Ended

Catalog Number	Tip Size (mm)	Length (in.)
MG270R	SET OF 8	-
MG251R	1/2	8
MG252R	3/4	8
MG253R	5/6	8
MG254R	7/8	8
MG255R	9/10	8
MG256R	11/12	8
MG257R	13/14	8
MG258R	15/16	8
MG259R	17/18	8

MG270R Set of 8 includes MG252R-MG259R



MG270R-MG259R

PRATT Uterine Dilator

Catalog Number	Tip Size (FR)	Length (in.)
EM270R	COMPLETE SET	-
EM271R	13/15	11 1/2
EM272R	17/19	11 1/2
EM273R	21/23	11 1/2
EM274R	25/27	11 1/2
EM275R	29/31	11 1/2
EM276R	33/35	11 1/2
EM277R	37/39	11 1/2
EM278R	41/43	11 1/2

EM270R Set of 8 includes EM271R-EM278R



EM270R-EM278R

HANK Dilator, French Scale

Catalog Number	Tip Size (FR)	Length (in.)
MD593R	COMPLETE SET	10
MD579R	9/10	10
MD594	11/12	10
MD595	13/14	10
MD596	15/16	10
MD597	17/18	10
MD598	19/20	10

MD593R Set of 6 includes MD579R, MD594-MD598



MD593R-MD598

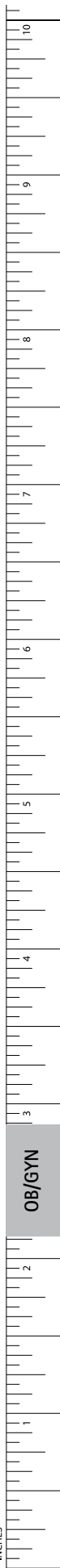

Obstetrics/Gynecology

Dilators and Probes

HANK Dilator, American Scale

Catalog Number	Tip Size (mm)	Length (in.)
MD070R	COMPLETE SET	-
MD064R	9/10	10 3/4
MD065R	11/12	10 3/4
MD066R	13/14	10 3/4
MD067R	15/16	10 3/4
MD068R	17/18	10 3/4
MD069R	19/20	10 3/4

MD070R Set of 6 includes MD064R-MD069R



MD070R-MD069R

SIMS Uterine Probe, Graduated (cm)

Catalog Number	Tip	Tip Size (mm)	Blade	Length (in.)
EO010R	RGD	4	CVD	13
EO012R	MALL	4	CVD	13

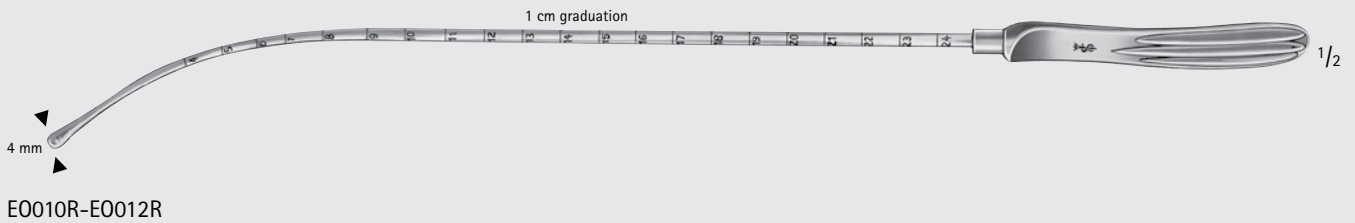

EO010R-EO012R

MARTIN Uterine Probe, Graduated (cm)

Catalog Number	Blade	Length (in.)
EO015R	CVD	11 3/4

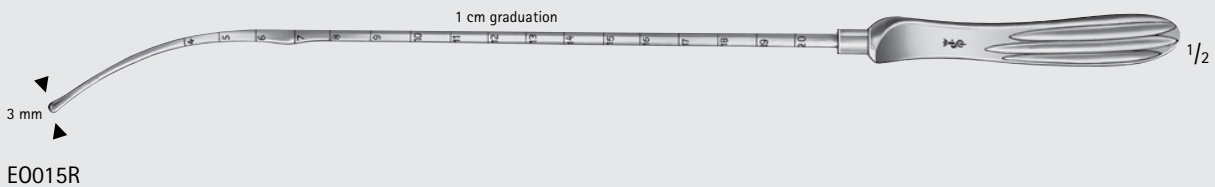

EO015R

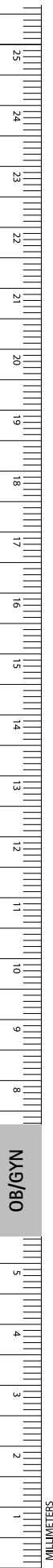

OB/GYN

**VALLEIX Uterine Probe,
Graduated (cm), W/ Slider**

Catalog Number	Tip Size (mm)	Blade	Length (in.)
E0016R	4	CVD	9 3/4

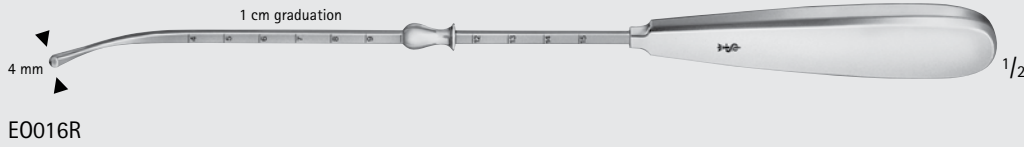

**SIMPSON Uterine Probe,
Graduated (cm)**

Catalog Number	Tip	Tip Size (mm)	Blade	Length (in.)
E0020	MALL	4	CVD	12 1/4

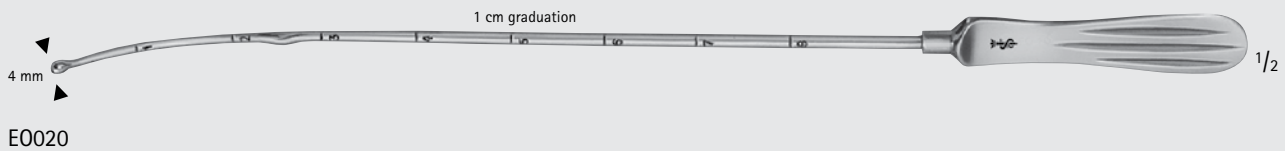

**BRAUN Uterine Depressor, Double
Ended**

Catalog Number	Blade Size (mm)	Length (in.)
E0030R	24/28	10 5/8



OB/GYN

Obstetrics/Gynecology

Curettes



ASCH Uterine Secretion Scoop, Malleable, Double Ended

Catalog Number	Length (in.)
ER005R	7 7/8

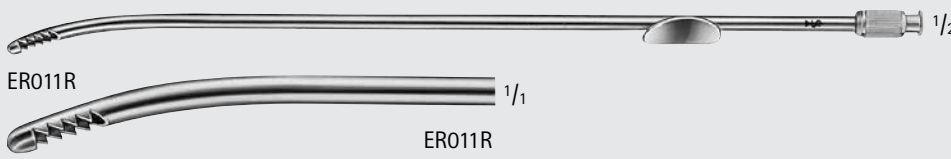

NOVAK Endometrial Biopsy Suction Curette

Catalog Number	Length (in.)
ER011R	9 1/2

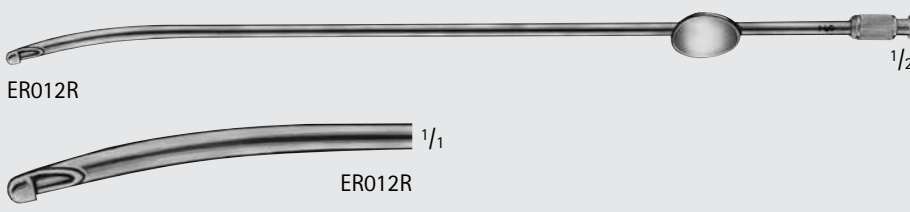

RANDALL Endometrial Suction and Biopsy Curette

Catalog Number	Length (in.)
ER012R	9 1/2

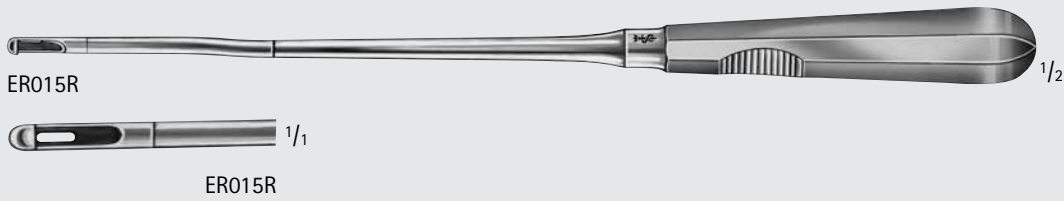

BERLIN Endometrial Biopsy Curette

Catalog Number	Tip Size (mm)	Length (in.)
ER015R	3.5	10 5/8

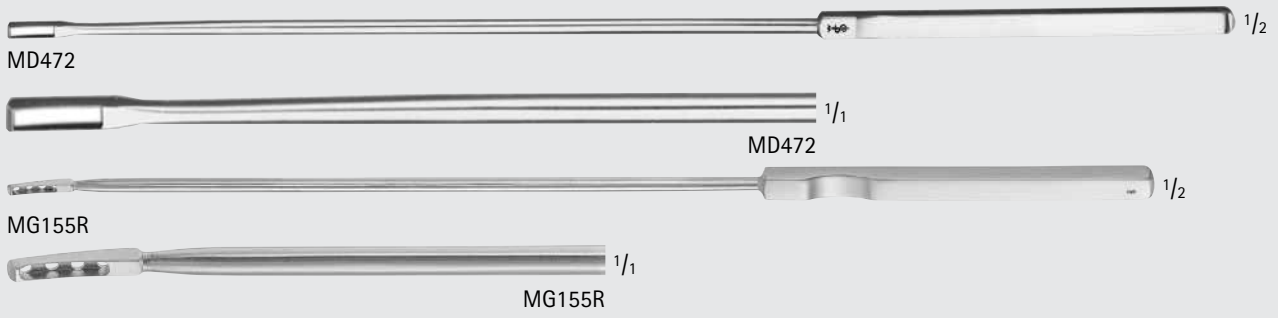

KEVORKIAN-YOUNGE Biopsy Curette

Catalog Number	Tip	Description	Length (in.)
MD472	SLIGHT-CVD	W/O Basket	13
MG155R	SLIGHT-CVD	W/ Basket	12 1/4

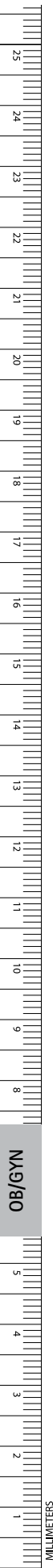

RECAMIER Uterine Curette

Catalog Number	Tip Size (#)	Tip Size (mm)	Tip	Length (in.)
ER219R	00	4.5	SHARP	11 3/4
ER220R	0	7.5	SHARP	11 3/4
ER221R	1	8.5	SHARP	11 3/4
ER222R	2	10.5	SHARP	11 3/4
ER223R	3	12.0	SHARP	11 3/4
ER224R	4	14.0	SHARP	11 3/4
ER225R	5	15.0	SHARP	11 3/4
ER226R	6	16.5	SHARP	11 3/4
ER227R	7	18.0	SHARP	11 3/4
ER228R	8	19.5	SHARP	11 3/4
ER229R	9	21.5	SHARP	11 3/4
ER230R	10	23.5	SHARP	11 3/4
ER241R	1	8.5	SHARP/MALL	11 3/4
ER242R	2	10.5	SHARP/MALL	11 3/4
ER243R	3	12.0	SHARP/MALL	11 3/4
ER244R	4	14.0	SHARP/MALL	11 3/4
ER245R	5	15.0	SHARP/MALL	11 3/4
ER246R	6	16.5	SHARP/MALL	11 3/4
ER247R	7	18.0	SHARP/MALL	11 3/4
ER248R	8	19.5	SHARP/MALL	11 3/4
ER320R	0	7.5	BLUNT	11 3/4
ER321R	1	8.5	BLUNT	11 3/4
ER322R	2	10.5	BLUNT	11 3/4
ER323R	3	12.0	BLUNT	11 3/4
ER324R	4	14.0	BLUNT	11 3/4
ER325R	5	15.0	BLUNT	11 3/4
ER326R	6	16.5	BLUNT	11 3/4
ER327R	7	18.0	BLUNT	11 3/4
ER328R	8	19.5	BLUNT	11 3/4
ER329R	9	21.5	BLUNT	11 3/4
ER330R	10	23.5	BLUNT	11 3/4
ER611R	1	34.5	BLUNT	14 1/4
ER612R	2	39.5	BLUNT	14 1/4



ER219R-ER330R

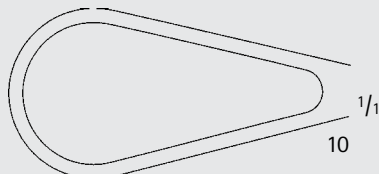
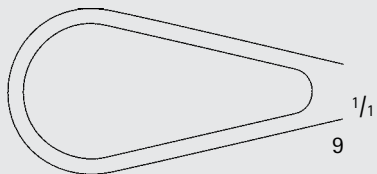
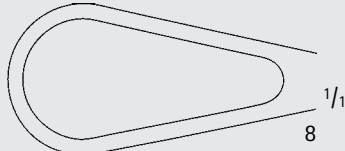
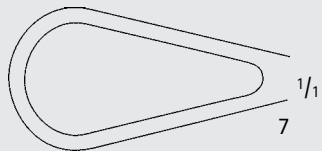
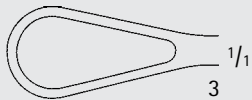
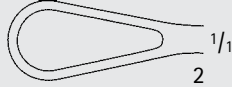
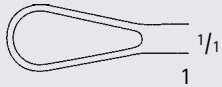
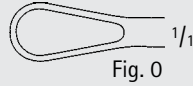
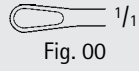
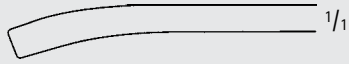

ER611R-ER612R

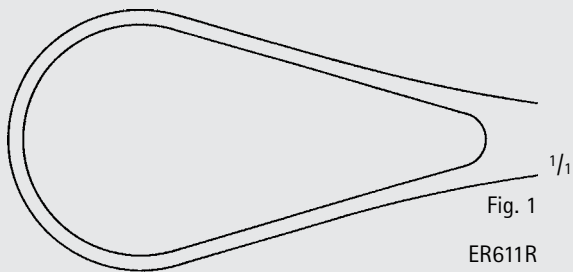

ER611R

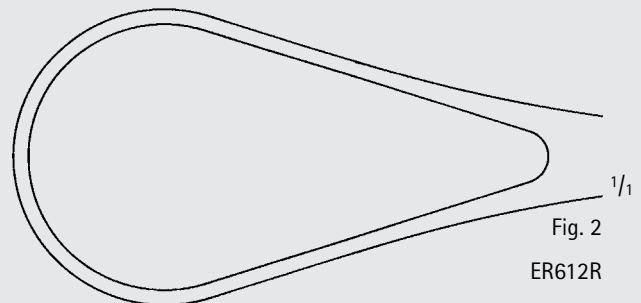

ER612R



OB/GYN

INCHES

Obstetrics/Gynecology

Curettes

SIMS Uterine Curette

Catalog Number	Tip Size (#)	Tip Size (mm)	Tip	Length (in.)
ER401R	1	7.5	SHARP	10
ER402R	2	8.5	SHARP	10
ER403R	3	10.5	SHARP	10
ER404R	4	12.0	SHARP	10
ER405R	5	14.0	SHARP	10
ER406R	6	15.0	SHARP	10
ER411R	1	7.5	SHARP/MALL	10
ER412R	2	8.5	SHARP/MALL	10
ER413R	3	10.5	SHARP/MALL	10
ER414R	4	12.0	SHARP/MALL	10
ER415R	5	14.0	SHARP/MALL	10
ER416R	6	15.0	SHARP/MALL	10
ER421R	1	7.5	BLUNT	10
ER422R	2	8.5	BLUNT	10
ER423R	3	10.5	BLUNT	10
ER424R	4	12.0	BLUNT	10
ER425R	5	14.0	BLUNT	10
ER426R	6	15.0	BLUNT	10
MG140R	000	4.5	SHARP/MALL	11
MG141R	00	5.6	SHARP/MALL	11
MG142R	0	6.2	SHARP/MALL	11
MG143R	1	7.3	SHARP/MALL	11
MG144R	2	8.5	SHARP/MALL	11
MG145R	3	9.4	SHARP/MALL	11
MG146R	4	10.6	SHARP/MALL	11
MG147R	5	11.5	SHARP/MALL	11
MG148R	6	12.6	SHARP/MALL	11



ER401R-MG148R

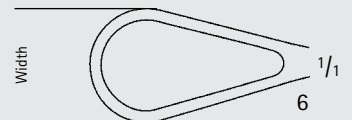
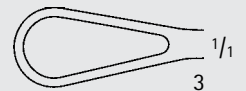
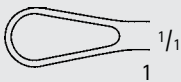
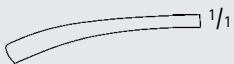

ER401R-ER426R

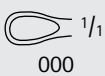

MG140R-MG148R



BUMM Uterine Curette, Blunt
Malleable

Catalog Number	Tip Size (#)	Tip Size (mm)	Length (in.)
ER520R	0	16.0	11 1/2
ER521R	1	18.0	11 1/2
ER522R	2	19.5	11 1/2
ER523R	3	21.5	11 1/2
ER524R	4	23.5	11 1/2
ER525R	5	26.0	11 1/2
ER526R	6	28.5	11 1/2



ER520R-ER526R

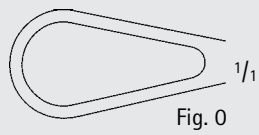

Fig. 0

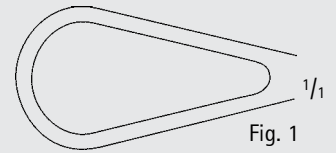
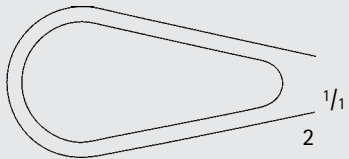
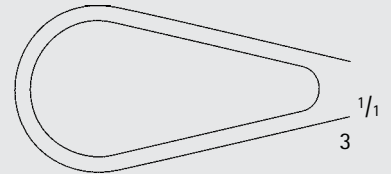

Fig. 1



2



3

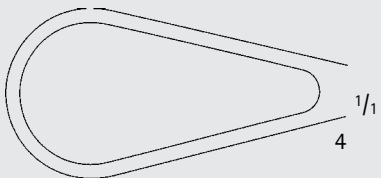

4

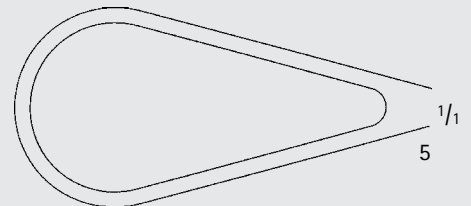

5

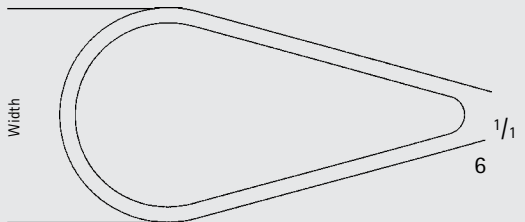

6

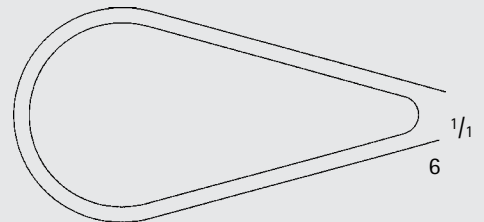

6



Obstetrics/Gynecology

Curettes

SIMS THOMAS Uterine Curette, Blunt/Malleable

Catalog Number	Tip Size (#)	Tip Size (mm)	Length (in.)
MG149R	0	6.0	11
ER211R	1	8.5	11
ER212R	2	10.5	11
ER213R	3	12.0	11
ER214R	4	14.0	11
ER215R	5	15.0	11
ER216R	6	16.5	11



MG149R-ER216R

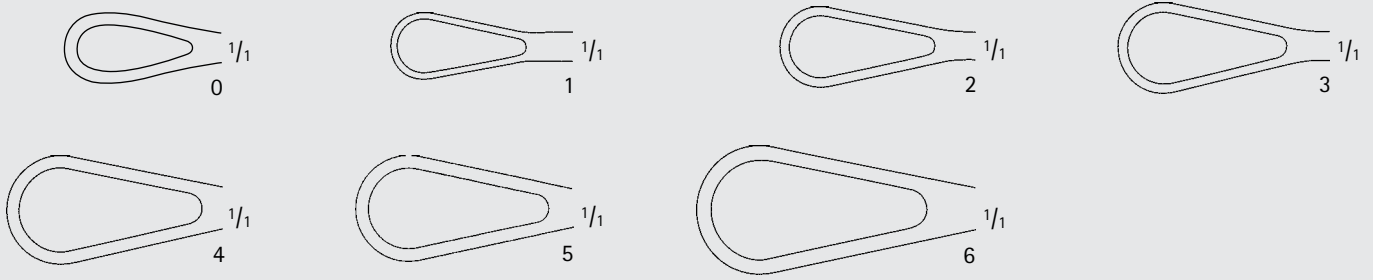

KELLY-GRAY Uterine Curette

Catalog Number	Tip Size (#)	Tip Size (mm)	Length (in.)
MB375R	1	5.0	9 1/2
MB376R	2	6.0	9 1/2
MB377R	3	7.5	9 1/2
MB378R	4	8.5	9 1/2



MB375R-MB378R

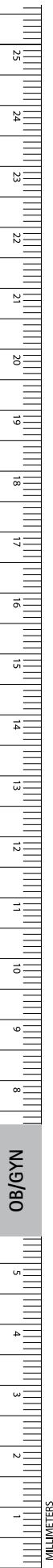

OB/GYN

HEANEY Uterine Curette, Malleable

Catalog Number	Tip	Length (in.)
ER025R	TOOTHED	9 1/2



ER025R



ER025R

COLLIN Uterine Curette, Rigid

Catalog Number	Tip	Length (in.)
ER580R	TOOTHED	11 3/4



ER580R



ER580R

BLAKE Uterine Curette, Double Ended

Catalog Number	Tip	Length (in.)
ER585R	SHARP/BLUNT	10 3/4



ER585R



1/1

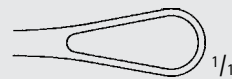

ER585R

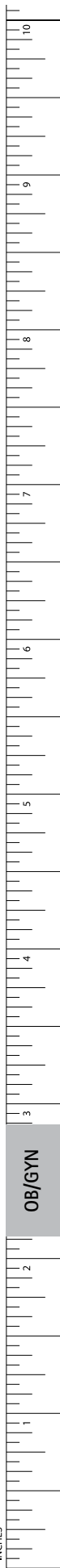

OB/GYN

INCHES

Obstetrics/Gynecology

Curettes

BUMM Uterine Curette

Catalog Number	Tip Size (#)	Tip Size (mm)	Tip	Length (in.)
ER621R	1	23.5	SHARP/MALL	12 1/4
ER623R	3	28.5	SHARP/MALL	12 1/4
ER626R	1	23.5	BLUNT/MALL	12 1/4
ER627R	2	26.0	BLUNT/MALL	12 1/4
ER628R	3	28.5	BLUNT/MALL	12 1/4



ER621R-ER628R

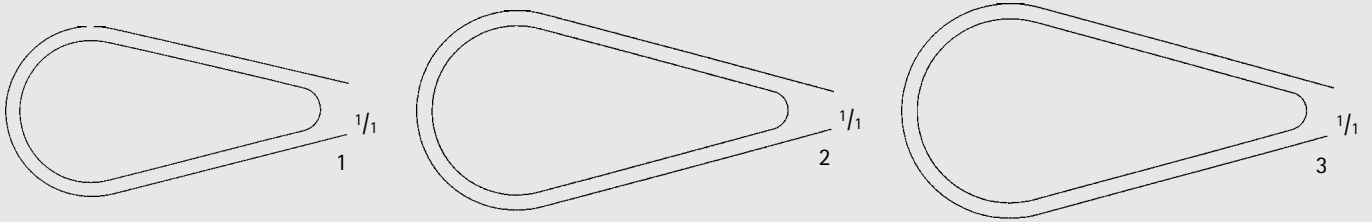

WALLICH Placenta/Ovum Scoop

Catalog Number	Tip	Length (in.)
ER602R	CVD	16 3/4



ER602R



ER602R

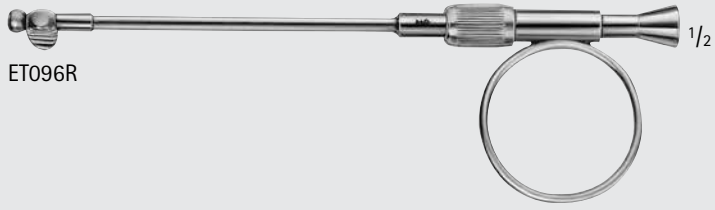

ET096R

Guide Sheath, IOWA Trumpet

Catalog Number	Tip Size (mm)	Description	Length (in.)
ET096R	—	—	6 7/8
SR580R	1 x 185	INJECTION NEEDLE, LUER-LOCK HUB	—



SR580R

Uterine Cannula W/ 2 Cones

Catalog Number	Length (in.)
ER876	13 3/4

- Cones:
 1 ER876201 (small)
 1 ER876202 (large)



ER876



Obstetrics/Gynecology

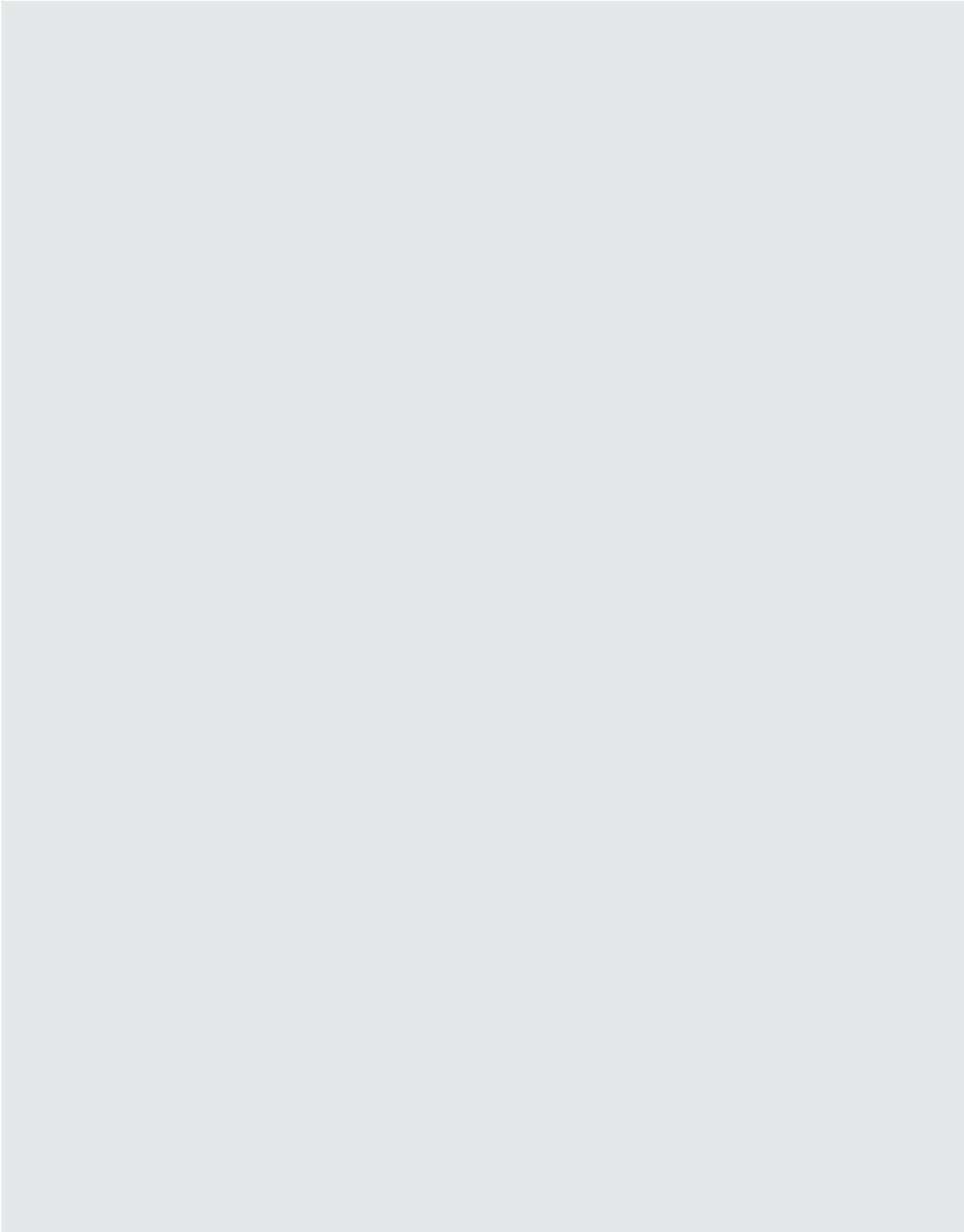
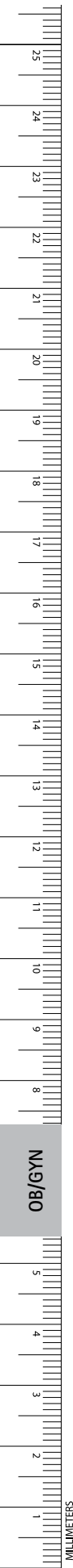



Urology

Needles	1298
Instruments for Radical Prostatectomy	1299 - 1302
Forceps and Clamps	1303 - 1313
Retractors	1314 - 1318
Catheters, Guides and Sounds	1319 - 1322

Urology

Needles

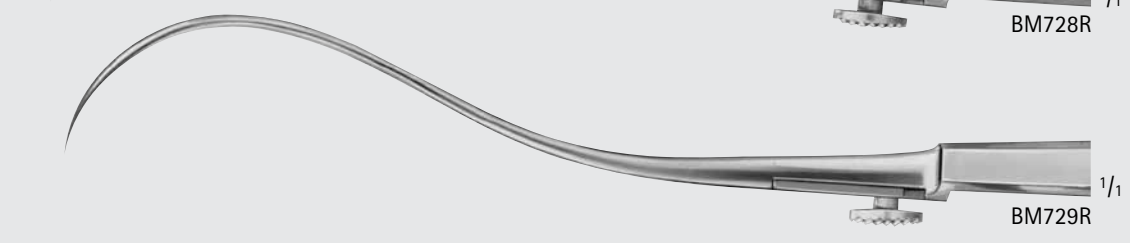
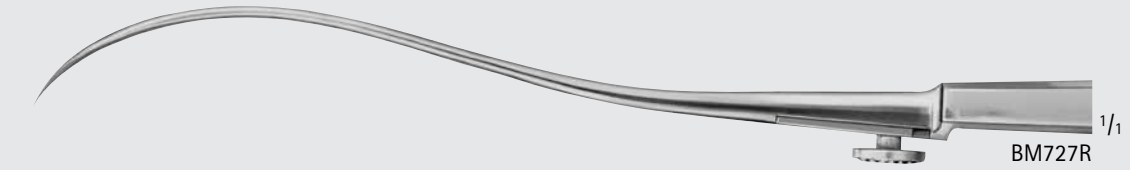
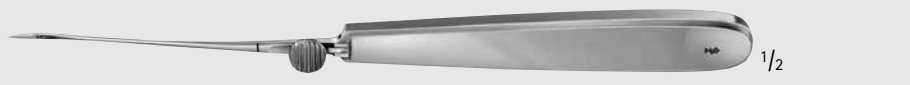
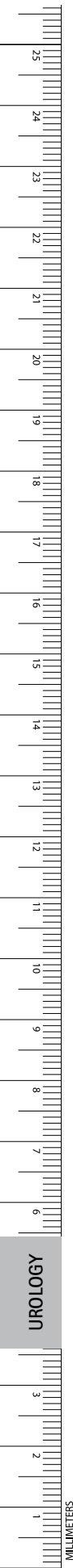

REVERDIN Needle

Catalog Number	Tip	Length (in.)
BM711R	SLIGHT-CVD	7 3/4
BM712R	CVD	7 3/4
BM713R	HEAVY-CVD	7 3/4
BM714R	X-HEAVY-CVD	7 3/4
BM726R	SLIGHT-CVD	9
BM727R	CVD	9
BM728R	HEAVY-CVD	9
BM729R	X-HEAVY-CVD	9

BARRÉ Scalpel Handle #3L, F/ Blade nos. 10-15, 40, 42

Catalog Number	Blade Shape	Blade Angle	Length (in.)
BB176R	ANG	12°	9 3/4



BB176R

1/2



BB176R

1/1

BARRÉ Scalpel Handle #3XL, F/ Blade nos. 10-15, 40, 42

Catalog Number	Blade Shape	Length (in.)
BB177R	STR	9 3/4



BB177R

1/2



BB177R

1/1

BARRÉ Scalpel Handle #3XL, F/ Blade nos. 10-15, 40, 42

Catalog Number	Blade Shape	Blade Angle	Length (in.)
BB178R	ANG	25°	9 3/4



BB178R

1/2



BB178R

1/1

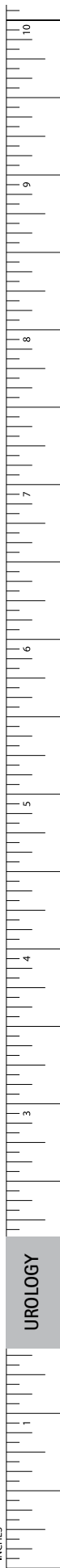

Urology

BARRÉ Instruments for Radical Prostatectomy

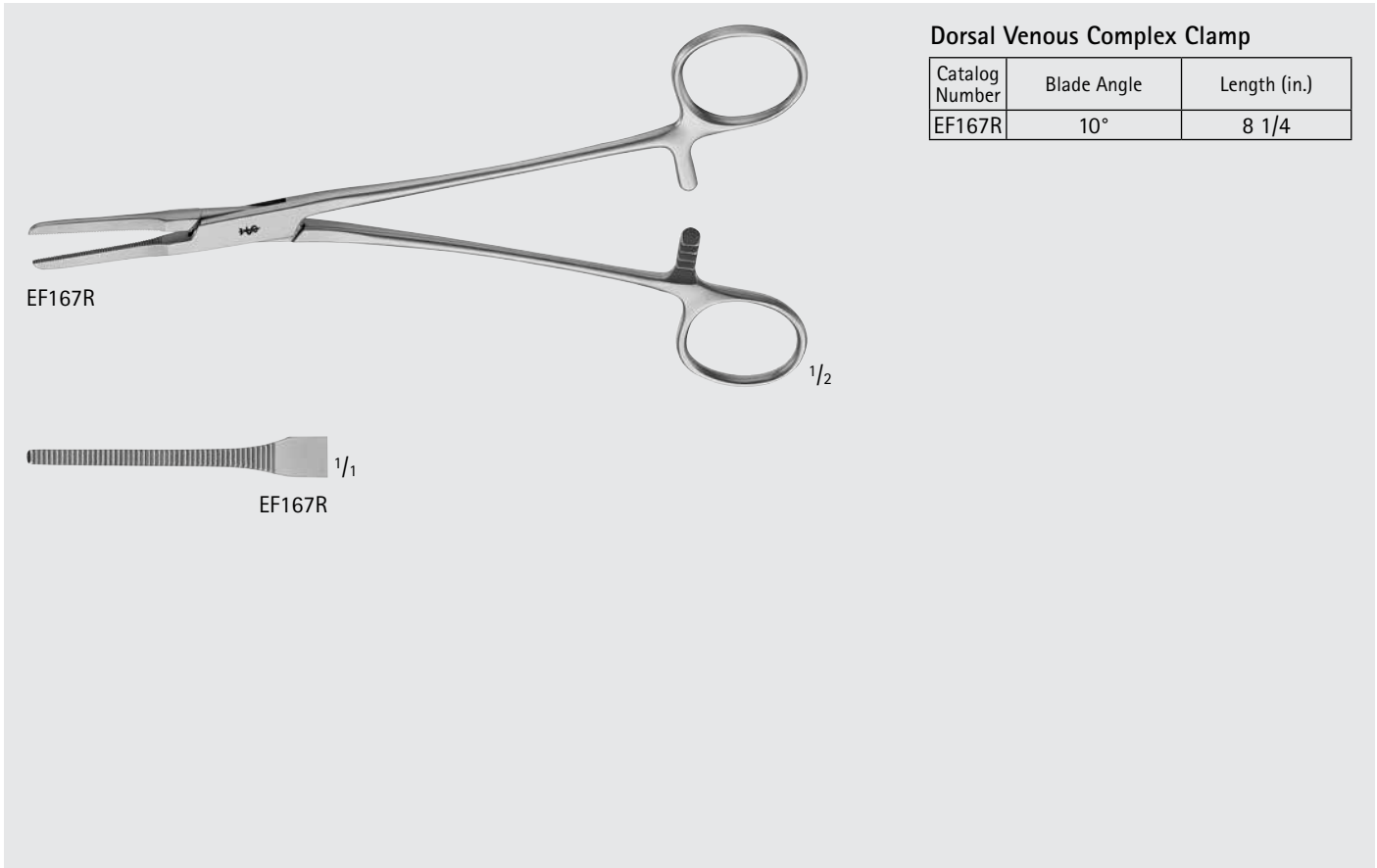
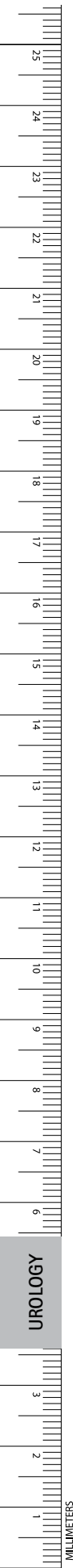

Dorsal Venous Complex Clamp

Catalog Number	Blade Angle	Length (in.)
EF167R	10°	8 1/4

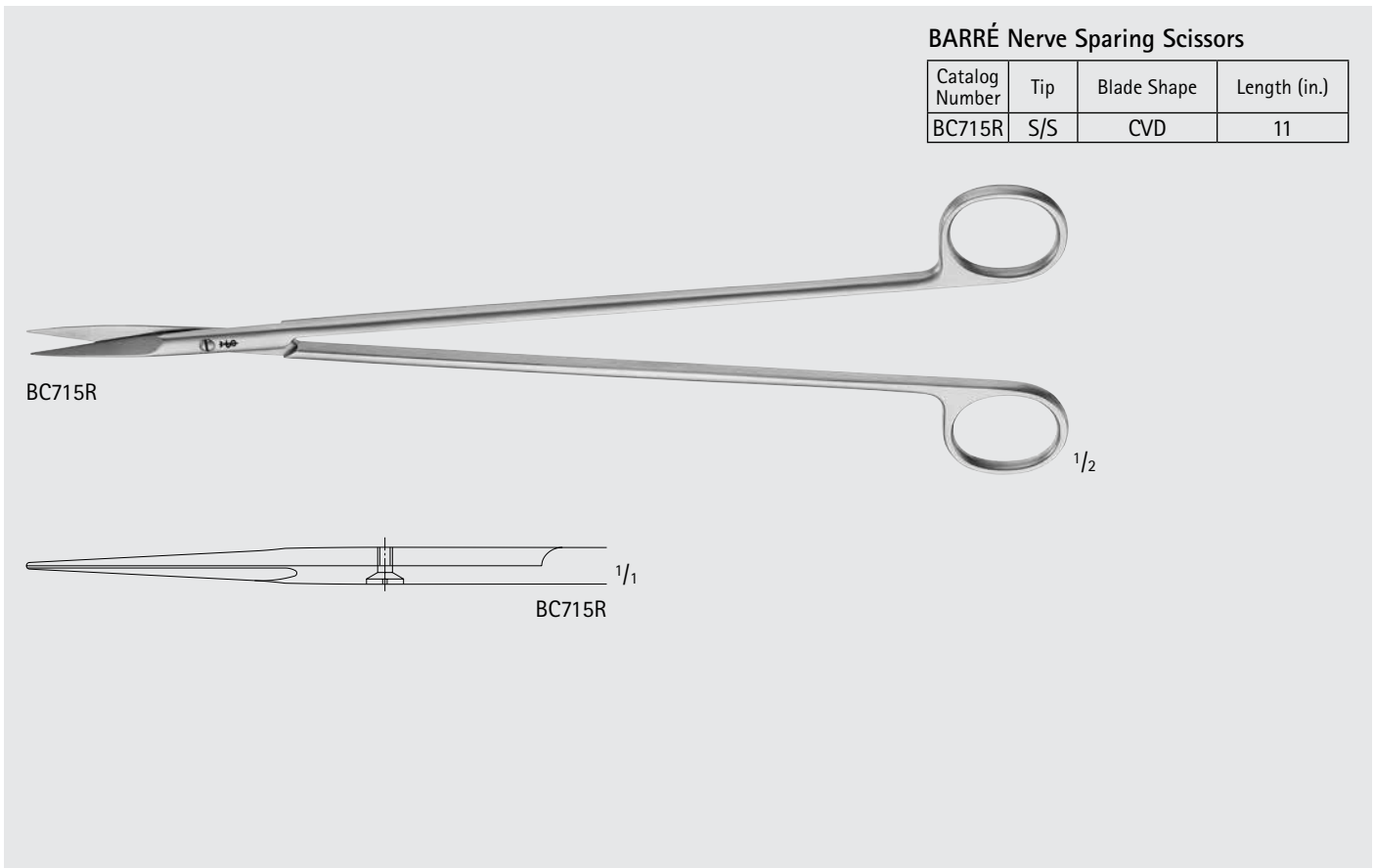

BARRÉ Nerve Sparing Scissors

Catalog Number	Tip	Blade Shape	Length (in.)
BC715R	S/S	CVD	11

BARRÉ Nerve Sparing Dissector

Catalog Number	Tip	Length (in.)
BJ029R	X-FINE	11
BJ110R	FINE	11

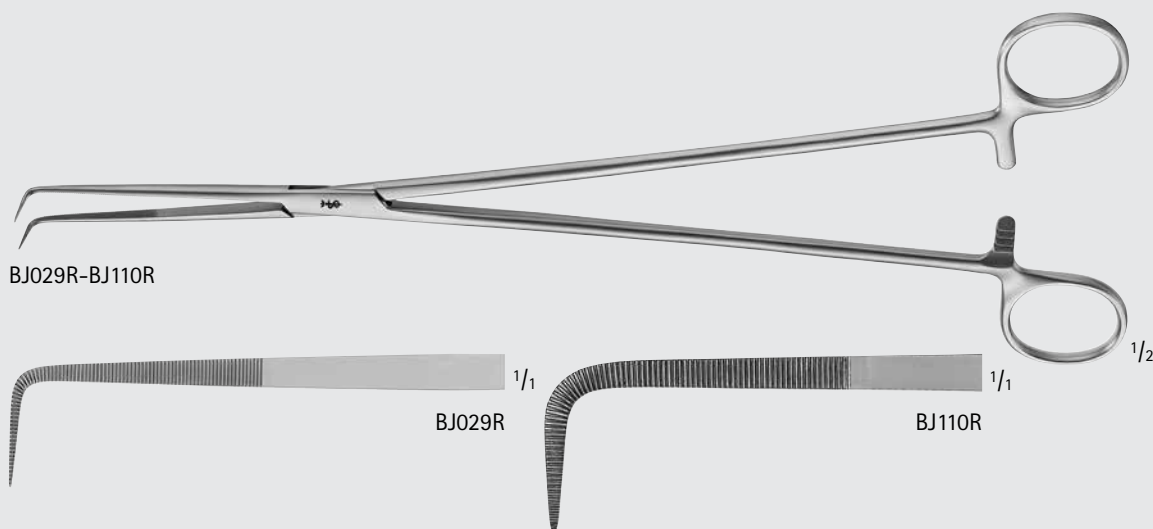

BJ029R-BJ110R

BJ029R

BJ110R

BARRÉ Prostate Retractor

Catalog Number	Length (in.)
BT680R	14 1/4

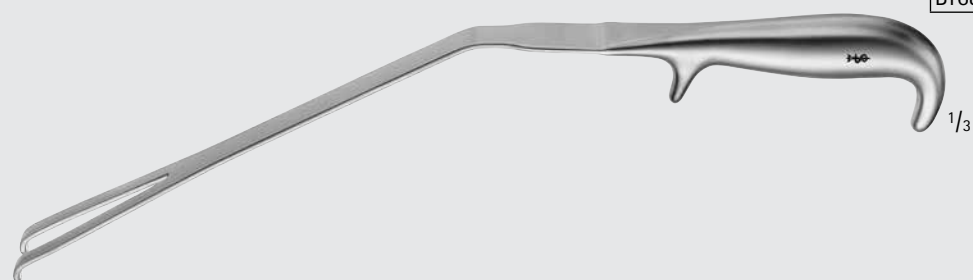

BT680R

BARRÉ Urethra Retractor

Catalog Number	Tip	Length (in.)
BT682R	SMALL	10 1/4
BT683R	LARGE	10 1/4
BT681R	—	15 3/8

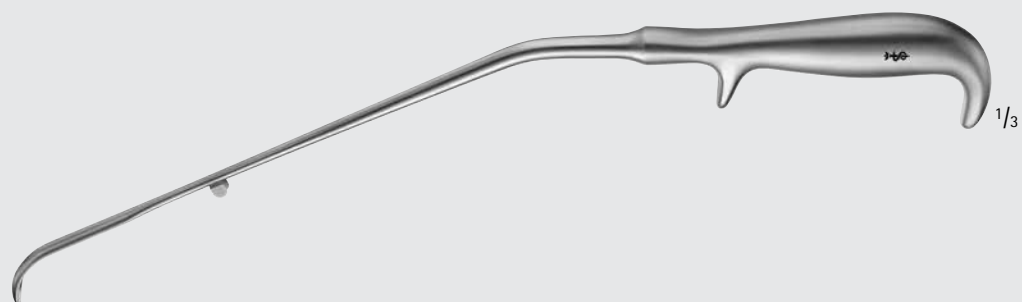

BT681R



Urology

BARRÉ Instruments for Radical Prostatectomy

BARRÉ Suture Holding Frame

Catalog Number	Length (in.)
BV927R	18 1/4

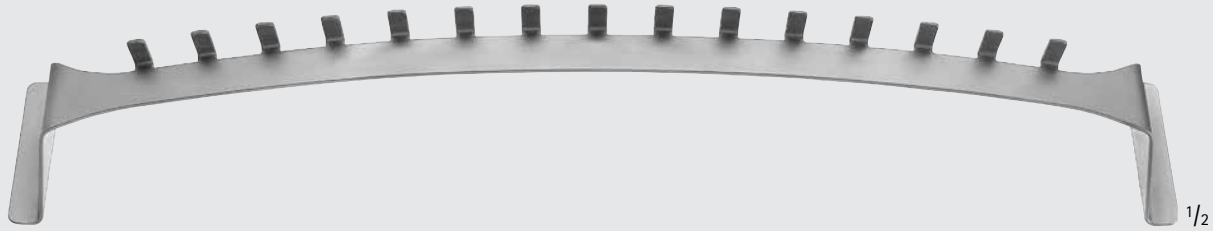

BV927R

1/2



BV921



BV922



BV840



BV849



BV925



BV924



BV926

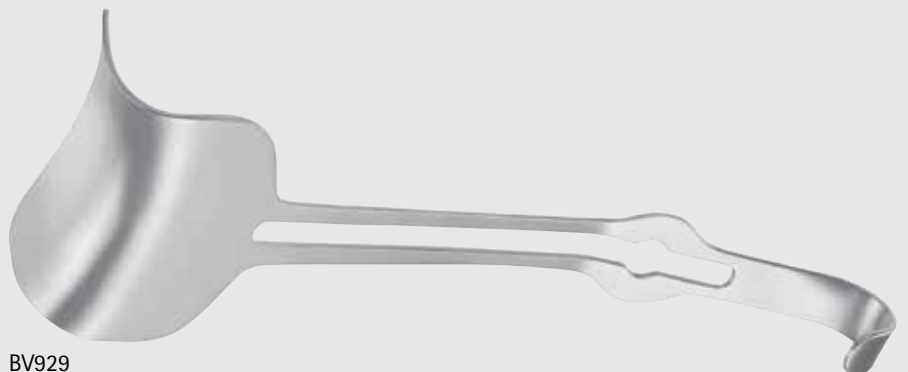

BV929

BARRÉ Prostatectomy Retractor

Catalog Number	Description	Blade Size, Depth x Width (in.)	Length (in.)
BV921R	COMPLETE RETRACTOR SYSTEM	-	
BV922R	RETRACTOR ONLY	-	
BV840R	MUENSTER OCTANGULAR NOTCH ROD	-	7 7/8
BV849R	MUENSTER UNIVERSAL CONNECTING CLAMP	-	2 3/8
BV925R	BARRÉ COLD LIGHT SUPPORT	-	
BV924R	BARRÉ RETRACTOR BLADES PAIR OF BLADES 2" DEPTH x 2 1/4" WIDTH	2 x 2 3/4	
BV926R	LATERAL BLADE MALLEABLE 2" DEPTH x 7 1/2" WIDTH	2 x 7 1/2	7 1/2
BV929R	CENTER BLADE 2 1/4" DEPTH x 2 3/4" WIDTH	2 1/4 x 2 3/4	9 1/4

BV921R Full Set includes:

- BV922R
- BV840R
- BV849R
- BV925R
- BV924R
- BV926R
- BV929R

Urology
Forceps and Clamps

GUYON Atraumatic Kidney Clamp

Catalog Number	Length (in.)
EF002R	9
EF001R	9 1/2

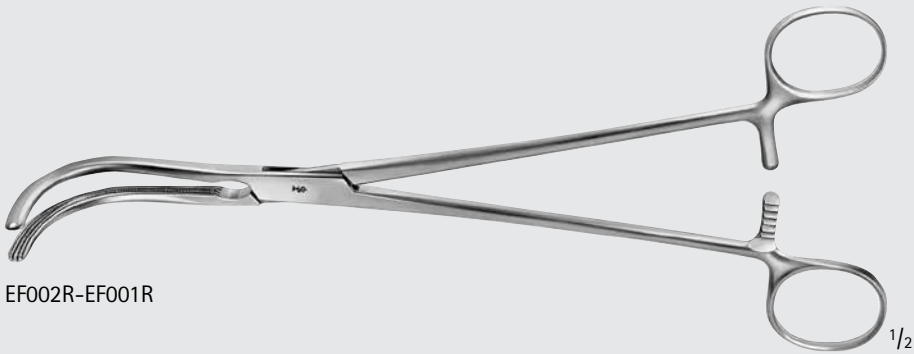

EF002R-EF001R

1/2

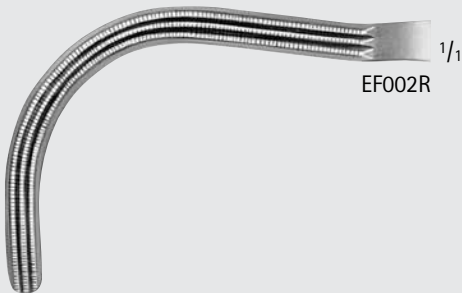

EF002R

1/1

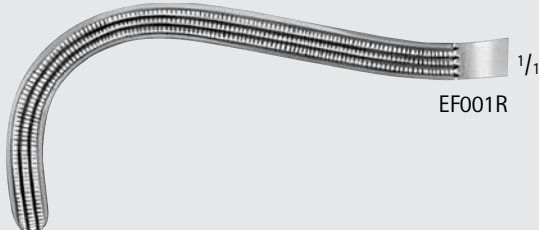

EF001R

1/1

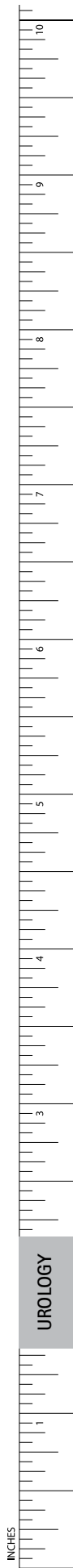

INCHES

Urology

Forceps and Clamps

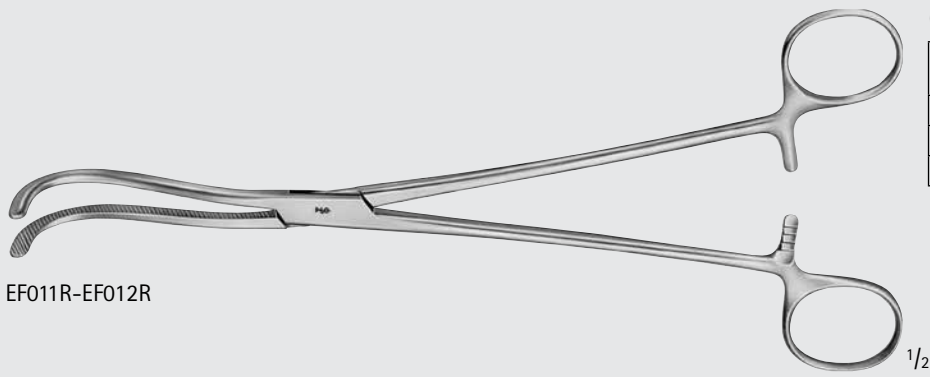

GUYON Kidney Clamp

Catalog Number	Length (in.)
EF011R	9
EF010R	9 1/4
EF012R	11

EF011R-EF012R

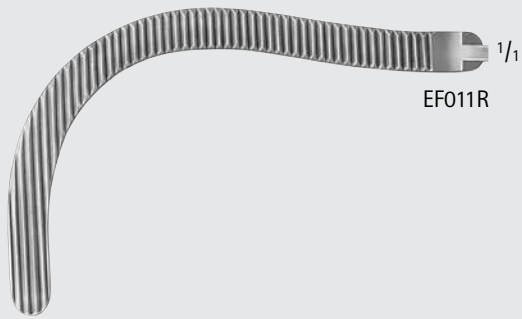

EF011R

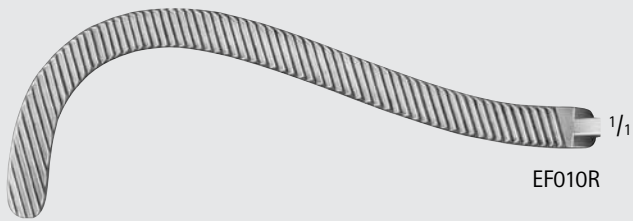

EF010R

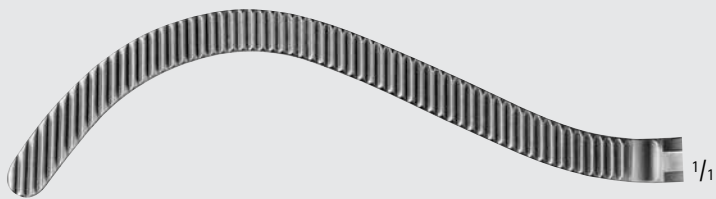

EF012R



STILLE Kidney Clamp

Catalog Number	Length (in.)
EF016R	8 7/8
EF015R	9 1/2

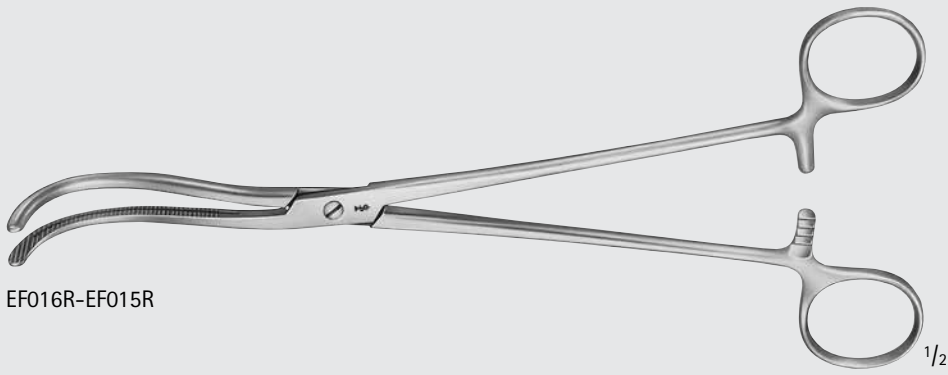

EF016R-EF015R



EF016R

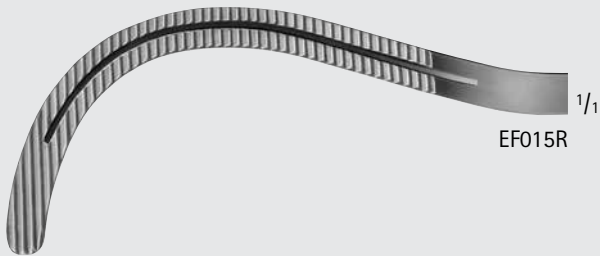

EF015R

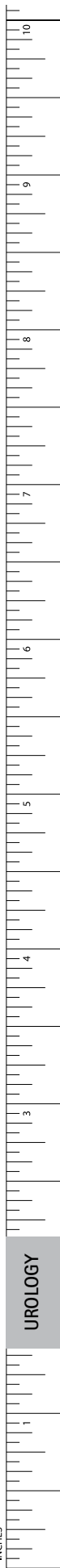

Urology

Forceps and Clamps

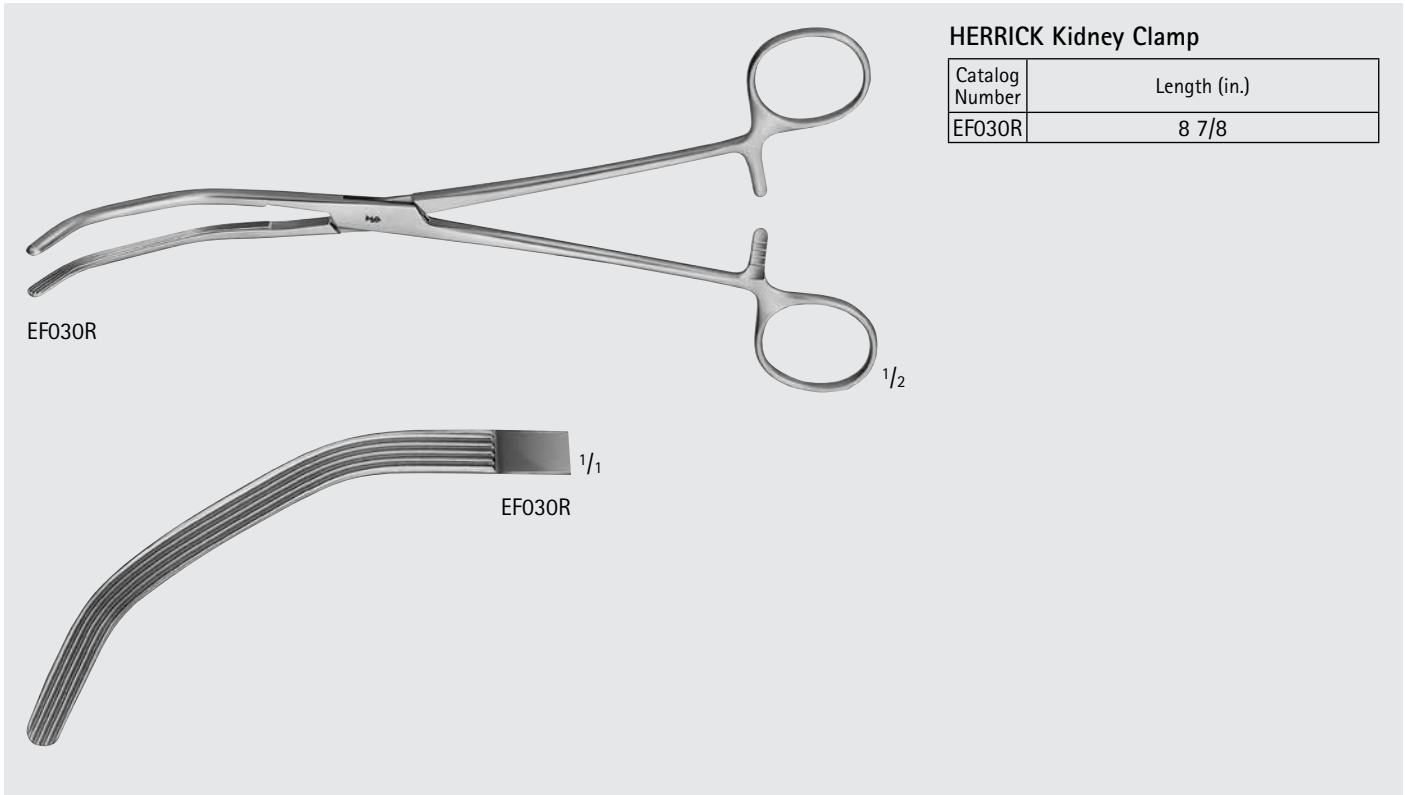
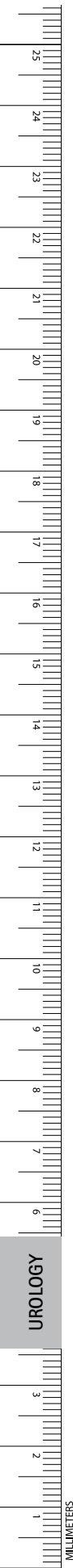

HERRICK Kidney Clamp

Catalog Number	Length (in.)
EF030R	8 7/8

EF030R

1/2

1/1

EF030R

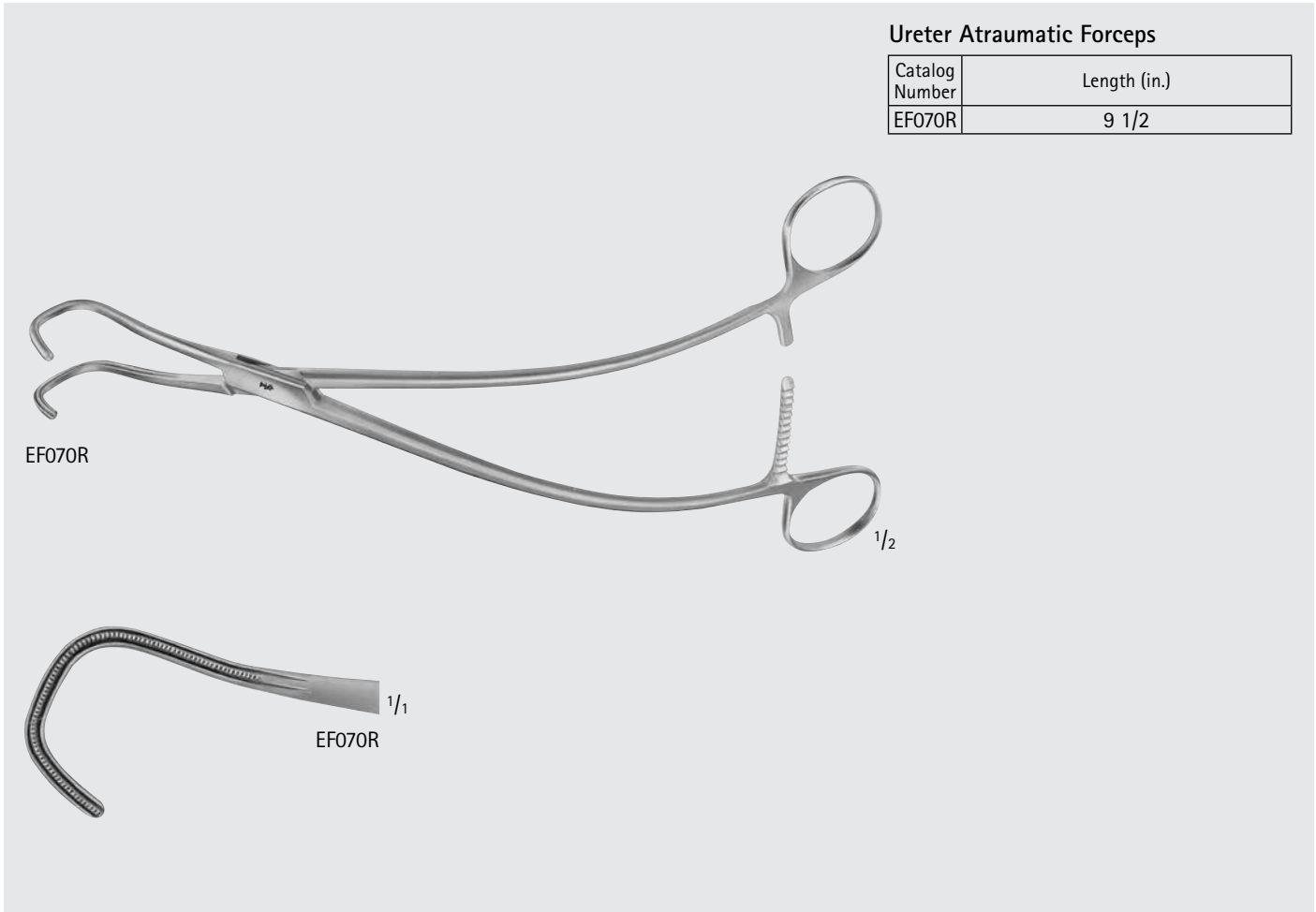

Ureter Atraumatic Forceps

Catalog Number	Length (in.)
EF070R	9 1/2

EF070R

1/2

1/1

EF070R

UROLOGY

MILLIMETERS

HEIMING Kidney Stone Forceps

Catalog Number	Jaw	Length (in.)
EF047R	SLIGHT-CVD	6 3/4
EF048R	HEAVY-CVD	6 1/4

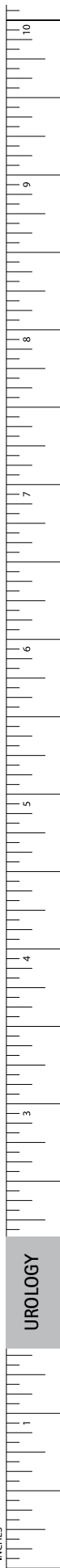
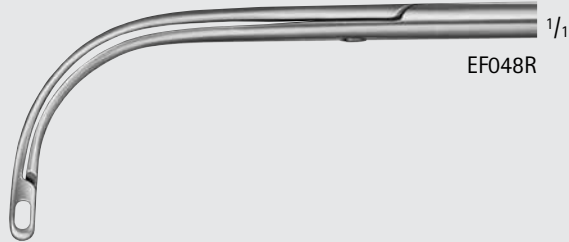
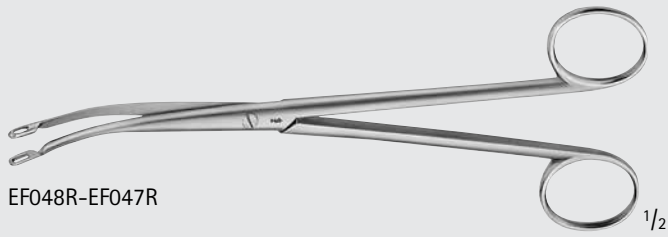

Urology

Forceps and Clamps

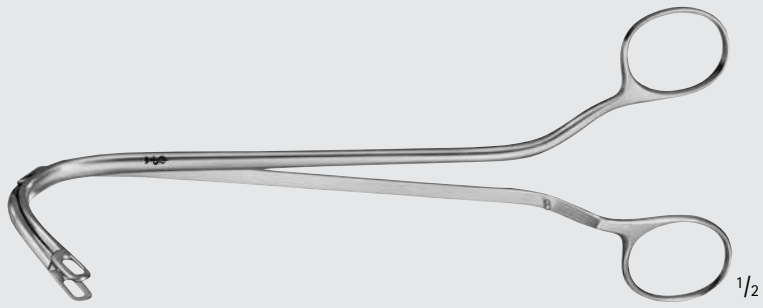

EF055R-EF056R

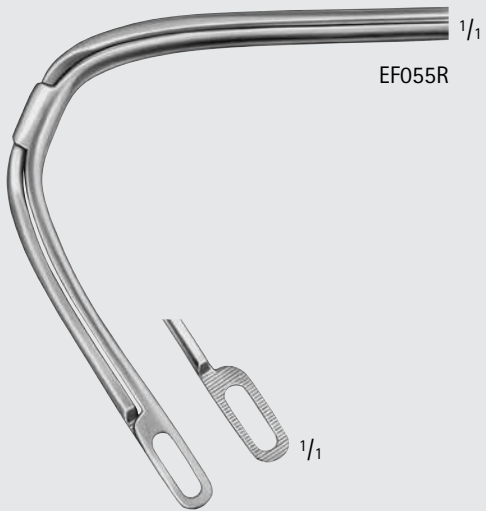

EF055R



1/1

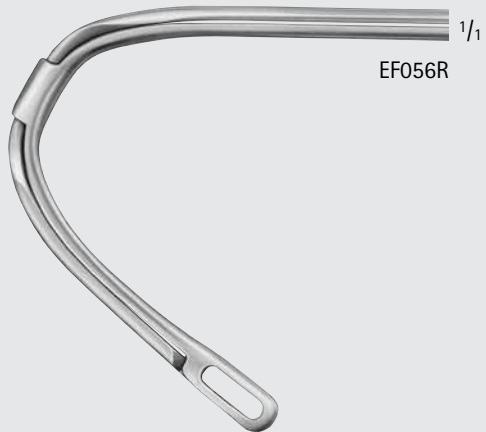

EF056R

RANDALL Kidney Stone Forceps

Catalog Number	Jaw	Length (in.)
EF055R	CVD	7 1/2
EF056R	HEAVY-CVD	7 1/2

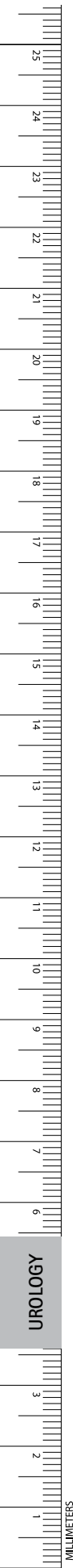

**RANDALL Kidney Stone Forceps
(continued)**

Catalog Number	Jaw	Length (in.)
EF051R	SLIGHT-CVD	8 7/8
EF052R	CVD	8 7/8
EF053R	HEAVY-CVD	8 7/8
EB246R	HEAVY CVD, VERY DELICATE	9
EF054R	U-CVD	8 7/8
EB244R	90° ANG	9 5/8

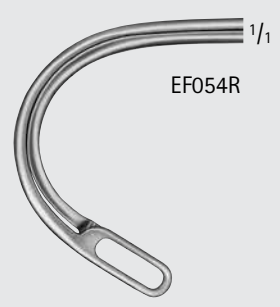
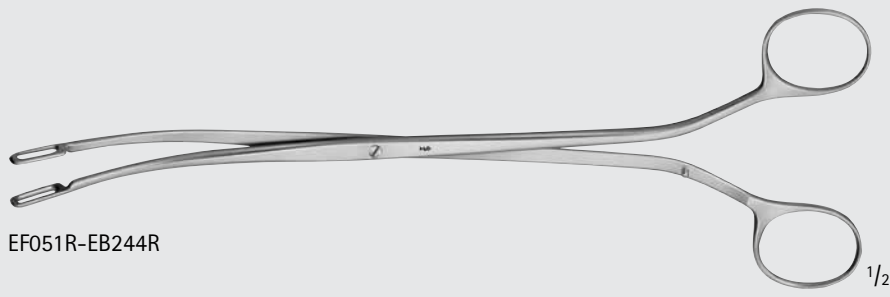

Urology

Forceps and Clamps

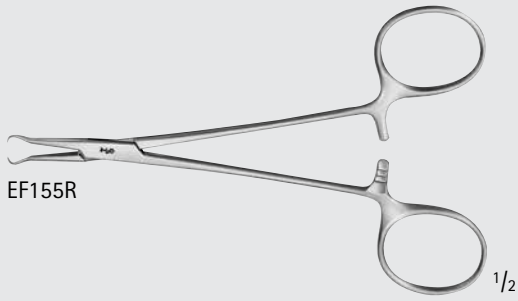

Genitourinary Forceps (F/ No Scalpel Set)

Catalog Number	Length (in.)
EF155R	5

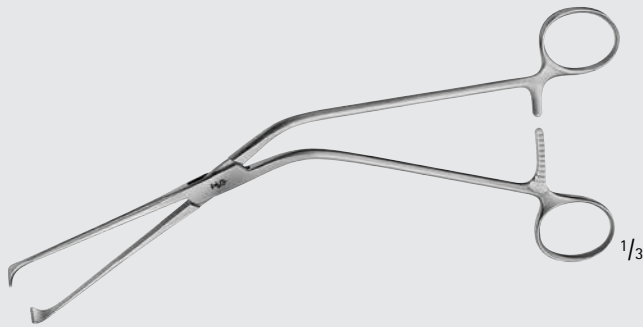

MILLIN Atraumatic Lobe Forceps

Catalog Number	Length (in.)
EF163R	9 5/8

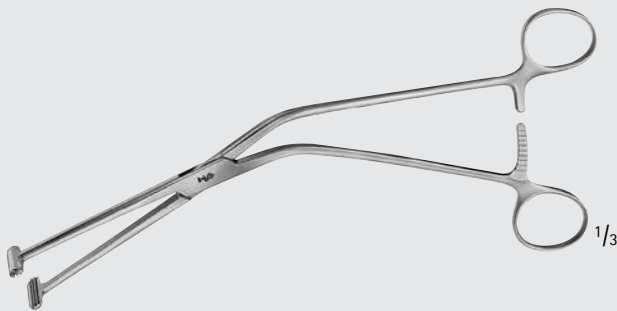

MILLIN Atraumatic T-Shaped Lobe Forceps

Catalog Number	Length (in.)
EF164R	9 1/4

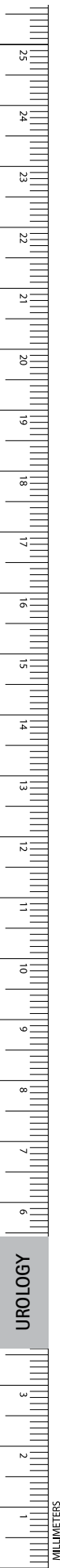
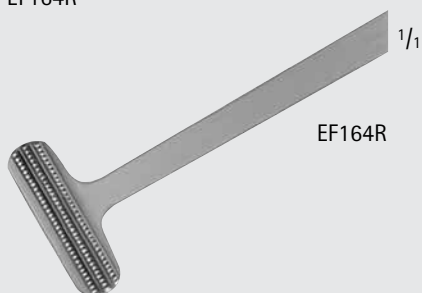

UROLOGY

MATHIEU Foreign Body Forceps

Catalog Number	Shaft Length (in.)
EF928R	7 1/2

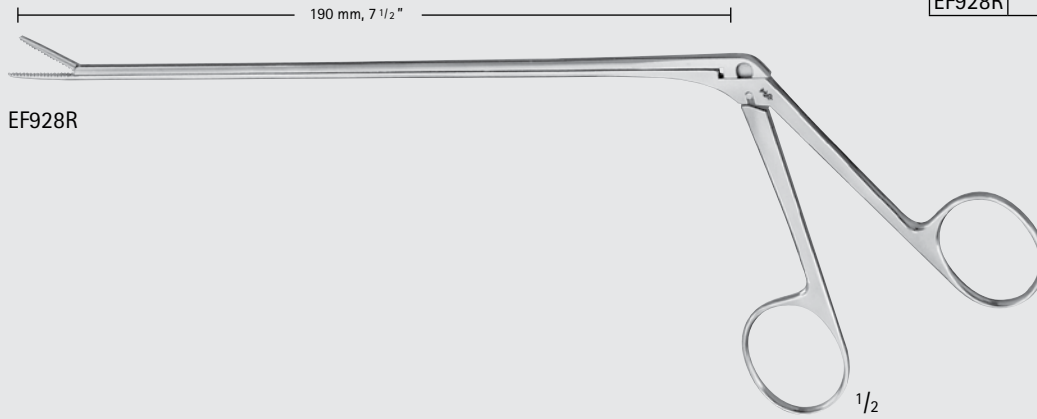

Spermatic Cord Fixation Clamp

Catalog Number	Length (in.)
EF195R	5 3/4

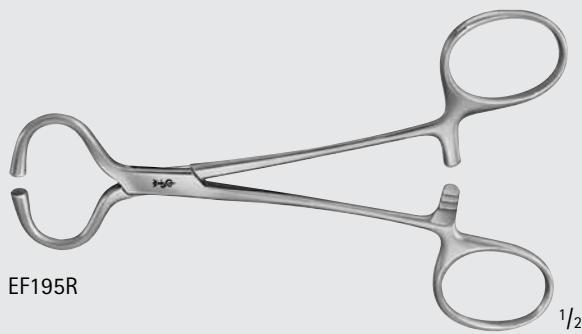

LEADER Vas Isolation Forceps

Catalog Number	Length (in.)
MG452R	5 1/4

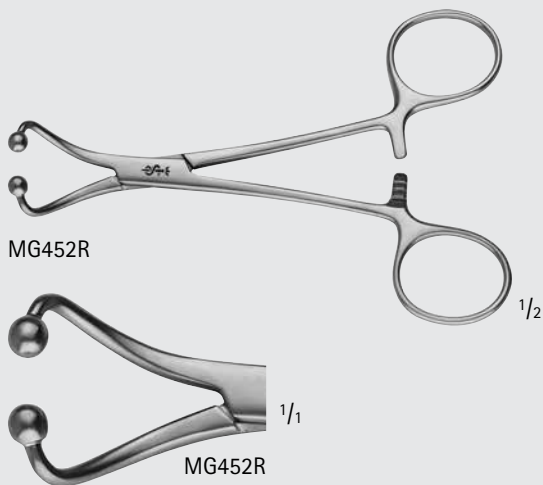

Urology

Forceps and Clamps

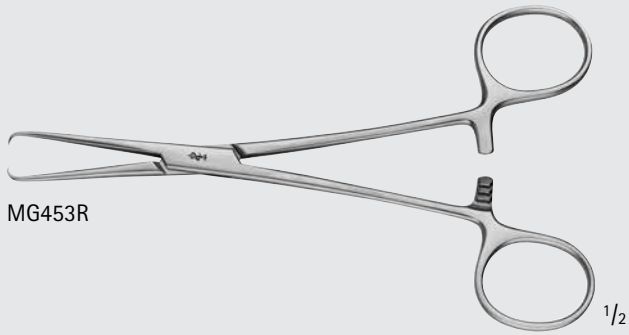

MG453R

1/2



1/1

MG453R

SANDERS Vasectomy Forceps

Catalog Number	Tip	Length (in.)
MG453R	1 x 1 PRONGS	6 1/8

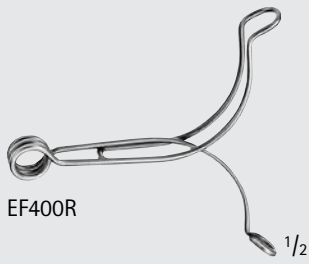

EF400R

1/2

STOCKMANN Penis Clamp

Catalog Number	Length (in.)
EF400R	2 3/4



EF401R

1/2

STRAUSS Penis Clamp

Catalog Number	Length (in.)
EF401R	5 1/8

UROLOGY



MG207R

ZIPSER Meatus Clamp

Catalog Number	Length (in.)
MG207R	4 1/4



EF965R-EF967R

WINKELMANN Circumcision Clamp

Catalog Number	Diameter (mm)
EF965R	12
EF966R	16
EF967R	20

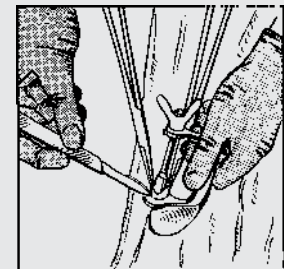
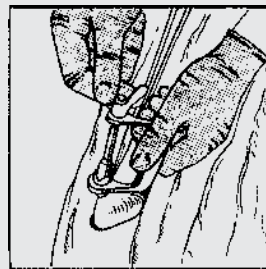

Assisted by two hemostats or ligatures the foreskin is pushed over the bell-shaped protection rod and the glans is placed into it. Next, the wing-nut is tightened as close as possible, so the foreskin is annular compressed. The foreskin is cut off with a scalpel adjacent to the compression ring. The circumcision clamp remains in place for a few minutes to avoid bleeding. If any large vein, specially the frenular artery, is cut, a ligature must be set. The advantage of the method described is the cosmetically favorable scar which is left after rejection of the small necrotized portion.



Urology

Retractors

LOWSLEY Prostatic Tractor

Catalog Number	Tip	Tip Size (FR)	Working Length (in.)	Length (in.)
MG080R	STR	20	9	12 1/4
MG079R	CVD	20	9 1/2	12 3/4



MG080R-MG079R



MG080R-MG079R

YOUNG Prostatic Tractor, Short

Catalog Number	Tip Size (mm)	Length (in.)
MG250R	25 x 25	8 5/8

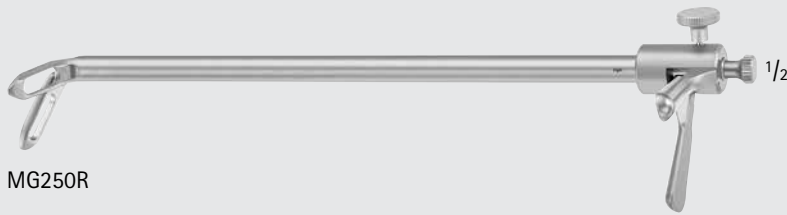

MG250R

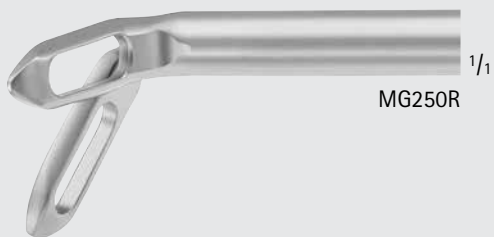

MG250R

LEGUEU Bladder Spatula Retractor

Catalog Number	Blade Size (mm)	Length (in.)
BV928R	35 / 90	10 1/4



BV928R

UROLOGY

WYLIE Renal Vein Retractor

Catalog Number	Blade Size (mm)	Length (in.)
MG179R	25 x 100	13 3/4
MG066R	25 x 175	12 3/4



MG066R-MG179R

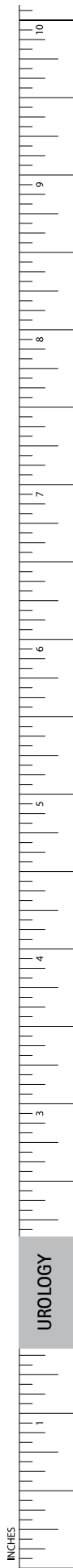

Urology

Retractors

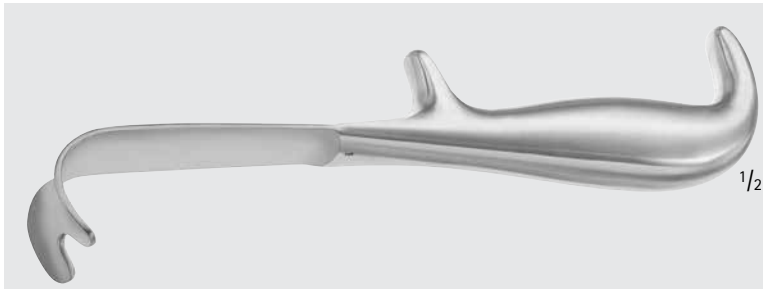
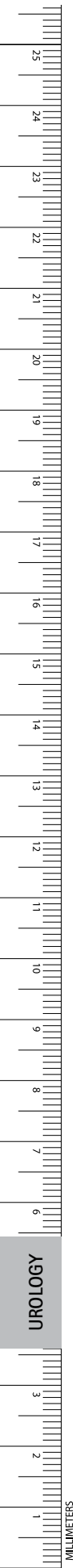

MG248R

YOUNG Bulb Retractor

Catalog Number	Blade Size (mm)	Length (in.)
MG248R	25 x 25	8 5/8

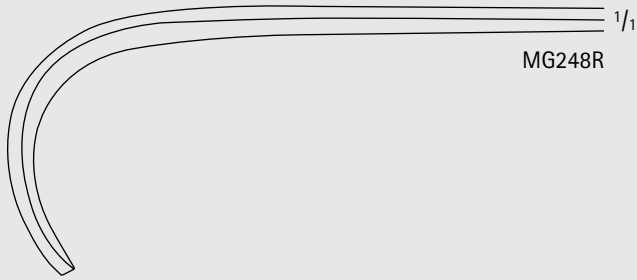

MG248R

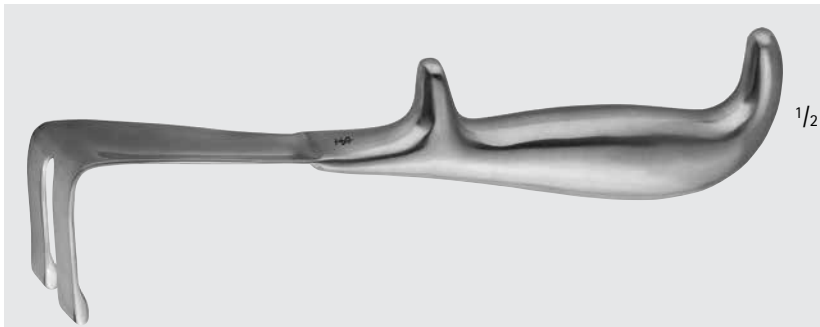

MG249R

YOUNG Prostatic Retractor, Bifurcated Blade W/ Deep Slots

Catalog Number	Blade Size (mm)	Length (in.)
MG249R	1 1/2 x 1 5/8	7 7/8

YOUNG Lateral Retractor

Catalog Number	Blade Size (mm)	Length (in.)
MG180R	50 x 11	8 1/4



MG180R

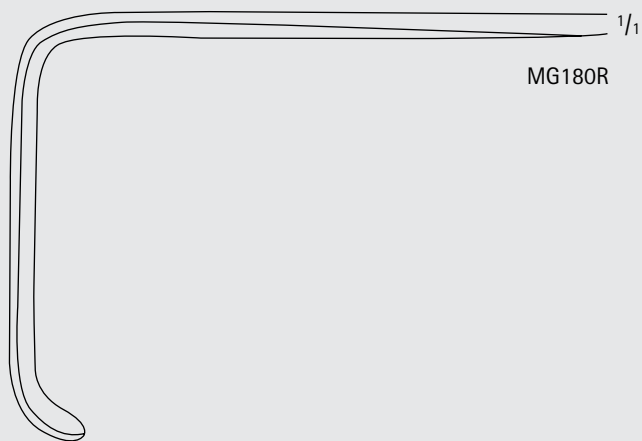

MG180R

YOUNG Anterior Retractor

Catalog Number	Blade Size (mm)	Length (in.)
MG181R	60 x 40	7 5/8

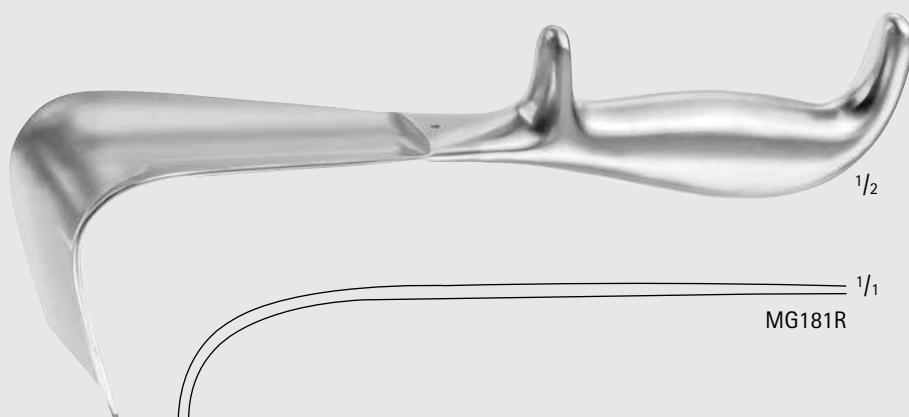

MG181R

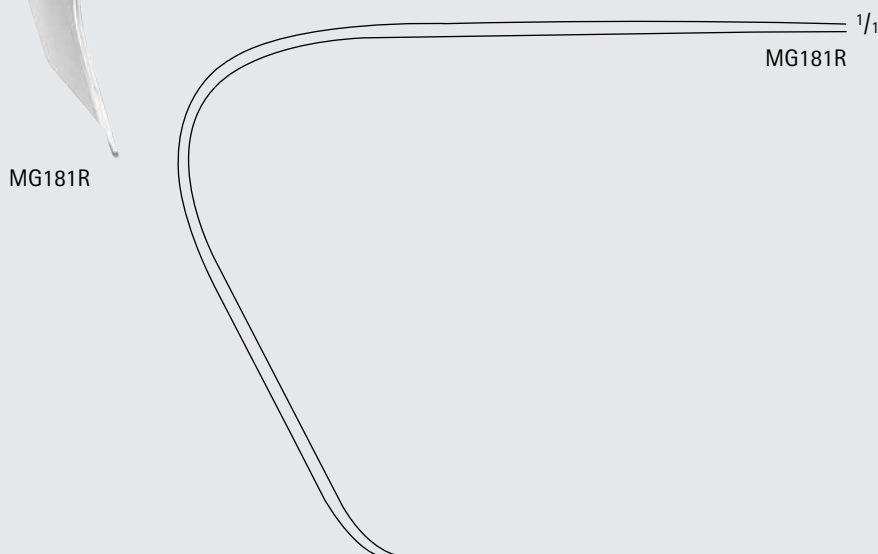

MG181R

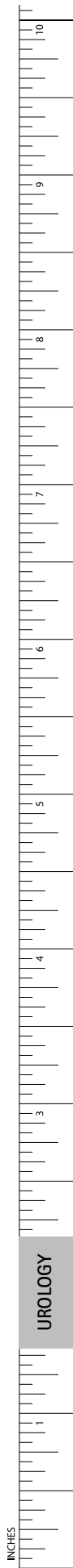

INCHES

Urology

Retractors



BT210R-BT217R

1/2



BT210R



BT211R



BT212R



BT213R



BT214R



BT215R



BT216R



BT217R

GIL VERNET Vein Retractor

Catalog Number	Blade Size (mm)	Length (in.)
BT210R	10 x 4	9 1/2
BT211R	10 x 6	9 1/2
BT212R	10 x 8	9 1/2
BT213R	10 x 11	9 1/2
BT214R	13 x 15	9 1/2
BT215R	13 x 17	9 1/2
BT216R	14 x 20	9 1/2
BT217R	16 x 23	9 1/2

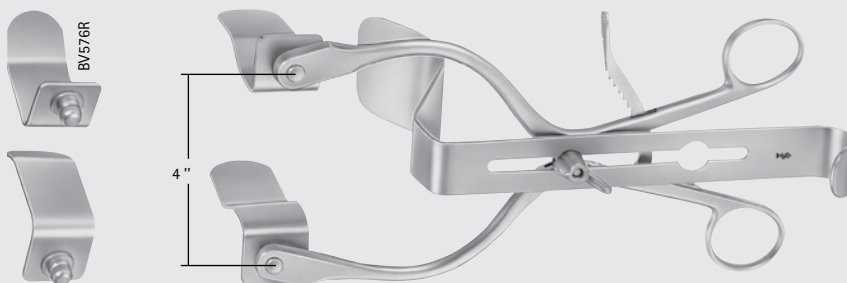

BV580R-BV578R

MILLIN Bladder Retractor

Catalog Number	Description
BV580R	COMPLETE SET
BV575R	SPREADER
BV576R	BLADES, 57 x 25 MM
BV577R	BLADES, 82 x 25 MM
BV578R	CENTER BLADE, 105 x 45 MM

BV580R Includes:

1 Spreader BV575R

1 Center Blade BV578R

2 Blades of each BV576R and BV577R

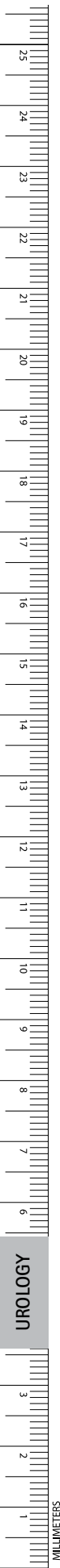

UROLOGY

MILLIMETERS

Female Catheter, Metal

Catalog Number	Tip Size (FR)	Length (in.)
EF306C	6	6 1/4
EF308C	8	6 1/4
EF310C	10	6 1/4
EF312C	12	6 1/4
EF314C	14	6 1/4
EF316C	16	6 1/4
EF318C	18	6 1/4



EF306C-EF318C

GUYON Wire Catheter Guide, Rigid

Catalog Number	Blade	Tip Size (FR)	Length (in.)
EF492R	CVD	7	14 3/8



EF492R

JEWETT Urethral Sound

Catalog Number	Tip Size (FR)	Shape	Length (in.)
MG240R	12	STR	9 1/2
MG241R	14	STR	9 1/2
MG242R	16	STR	9 1/2
MG243R	18	STR	9 1/2
MG244R	20	STR	9 1/2
MG245R	22	STR	9 1/2
MG246R	24	STR	9 1/2
MG247R	26	STR	9 1/2
MG128R	28	STR	9 1/2
MG129R	30	STR	9 1/2
MG130R	32	STR	9 1/2



MG240R-MG130R



Urology

Catheters / Guides / Sounds

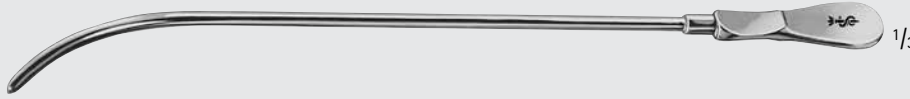

EF638R-EF660R

DITTEL Urethral Sound

Catalog Number	Tip Size (FR)	Length (in.)
EF638R	8	13 1/2
EF639R	9	13 1/2
EF640R	10	13 1/2
EF641R	11	13 1/2
EF642R	12	13 1/2
EF643R	13	13 1/2
EF644R	14	13 1/2
EF645R	15	13 1/2
EF646R	16	13 1/2
EF647R	17	13 1/2
EF648R	18	13 1/2
EF649R	19	13 1/2
EF650R	20	13 1/2
EF651R	21	13 1/2
EF652R	22	13 1/2
EF653R	23	13 1/2
EF654R	24	13 1/2
EF655R	25	13 1/2
EF656R	26	13 1/2
EF657R	27	13 1/2
EF658R	28	13 1/2
EF659R	29	13 1/2
EF660R	30	13 1/2

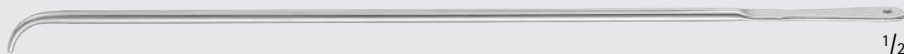

MG131R-MG139R

CAMPBELL Miniature Sound

Catalog Number	Tip Size (FR)	Length (in.)
MG131R	6	9 1/2
MG132R	8	9 1/2
MG133R	10	9 1/2
MG134R	12	9 1/2
MG135R	14	9 1/2
MG136R	16	9 1/2
MG137R	18	9 1/2
MG138R	20	9 1/2
MG139R	22	9 1/2



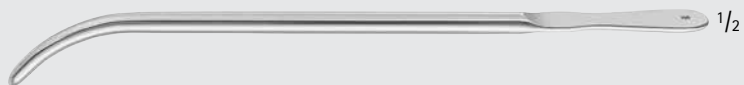

MB805R-MB884R

MCCREA Urethral Sound, Infant/Female

Catalog Number	Tip Size (FR)	Length (in.)
MB805R	8	7 1/4
MB806R	10	7 1/4
MB809R	12	7 1/4
MB810R	14	7 1/4
MB811R	16	7 1/4
MB813R	18	7 1/4
MB814R	20	7 1/4
MB815R	22	7 1/4
MB838R	24	7 1/4
MB839R	26	7 1/4
MB840R	28	7 1/4
MB881R	30	7 1/4
MB882R	32	7 1/4
MB883R	34	7 1/4
MB884R	36	7 1/4

VAN BUREN Urethral Sound

Catalog Number	Tip Size (FR)	Length (in.)
EF800R	8	10 5/8
EF801R	10	10 5/8
EF802R	12	10 5/8
EF803R	14	10 5/8
EF804R	16	10 5/8
EF805R	18	10 5/8
EF806R	20	10 5/8
EF807R	22	10 5/8
EF808R	24	10 5/8
EF809R	26	10 5/8
EF810R	28	10 5/8
EF811R	30	10 5/8
EF812R	32	10 5/8
EF813R	34	10 5/8
EF814R	36	10 5/8
EF815R	38	10 5/8
EF816R	40	10 5/8



EF800R-EF816R

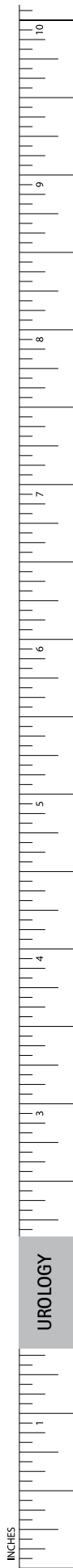

INCHES

Urology

Catheters

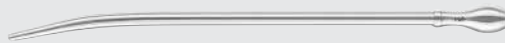

MB158R-MB169R

WALTHER Dilator-Catheter

Catalog Number	Tip Size (FR)	Length (in.)
MB158R	12	5 1/4
MB170R	14	5 1/4
MB173R	16	5 1/4
MB159R	18	5 1/4
MB160R	20	5 1/4
MB161R	22	5 1/4
MB162R	24	5 1/4
MB163R	26	5 1/4
MB164R	28	5 1/4
MB165R	30	5 1/4
MB166R	32	5 1/4
MB167R	34	5 1/4
MB168R	36	5 1/4
MB169R	38	6

OTIS Bougies a Boule, Olive Tip

Catalog Number	Tip Size (FR)	Length (in.)
MG111R	8	10
MG112R	10	10
MG113R	12	10
MG114R	14	10
MG115R	16	10
MG116R	18	10
MG117R	20	10
MG118R	22	10
MG119R	24	10
MG120R	26	10
MG121R	28	10
MG122R	30	10
MG123R	32	10
MG124R	34	10
MG125R	36	10
MG126R	38	10
MG127R	40	10



MG111R-MG127R

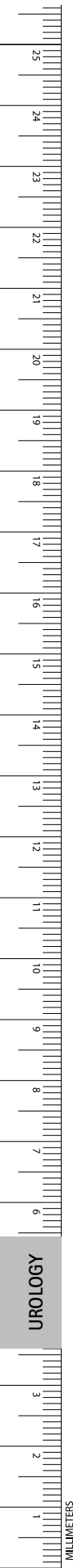

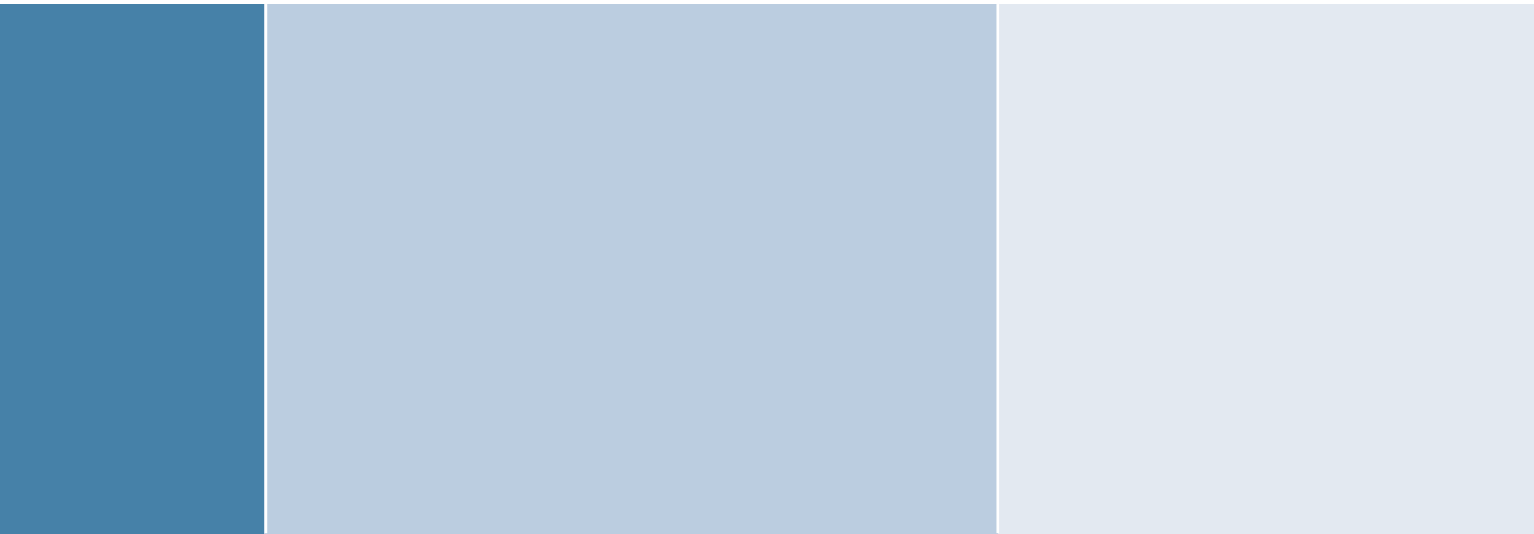

Numerical Index

Numerical Index

78 - BC

CATALOG NUMBER	PAGE	CATALOG NUMBER	PAGE	CATALOG NUMBER	PAGE	CATALOG NUMBER	PAGE
783101.....	324	AD127R.....	795	BB331R.....	301	BC110R.....	24, 813
783102.....	324	AD129R.....	795	BB332R.....	301	BC111R.....	24, 813
5518016.....	307	AN379R.....	147, 712	BB361R.....	302	BC112R.....	24, 813
5518032.....	307	AN380R.....	147, 712	BB362R.....	302	BC113R.....	24, 813
5518040.....	307	AN381R.....	147, 712	BB363R.....	302	BC117R.....	24, 813
5518059.....	307	AN710R.....	148, 719	BB364R.....	302	BC130R.....	2, 749
5518067.....	307	AN711R.....	148, 719	BB365R.....	302	BC131R.....	2, 749
5518075.....	307	AN909R.....	391	BB367R.....	302	BC135R.....	5, 749
5518083.....	307			BB368R.....	302	BC140R.....	749
5518091.....	307	A210.....	307	BB500.....	306	BC141R.....	749
5518105.....	307	BA211.....	307	BB510.....	306	BC144R.....	749
16600487.....	306	BA212.....	307	BB511.....	306	BC145R.....	749
16600495.....	306	BA215.....	307	BB512.....	306	BC153R.....	27
16600509.....	306	BA218.....	307	BB515.....	306	BC154R.....	27
16600517.....	306	BA219.....	307	BB520.....	306	BC156R.....	605, 754
16600525.....	306	BA220.....	307	BB521.....	306	BC157R.....	605, 754
16600550.....	306	BA221.....	307	BB522.....	306	BC160R.....	27
16600568.....	306	BA222.....	307	BB523.....	306	BC161R.....	27
16600576.....	306	BA223.....	307	BB524.....	306	BC162R.....	754
16600584.....	306	BA224.....	307	BB525.....	306	BC163R.....	755
16600592.....	306	BA706R.....	795	BB536.....	306	BC164R.....	25, 755, 816
16615522.....	306	BA708R.....	795	BB540.....	306	BC165R.....	25, 755, 816
16616634.....	306	BA709R.....	796	BB542.....	306	BC166R.....	606, 754
AA804R.....	323, 1065	BA711R.....	796	BC004R.....	608, 748, 812	BC168R.....	606, 754
AA805R.....	323, 1065	BA718R.....	797	BC005R.....	608, 748, 812	BC170R.....	609, 751, 815
AA806R.....	323, 1065	BA719R.....	797	BC006R.....	605, 754	BC171R.....	609, 751, 815
AA808R.....	323	BB046R.....	300	BC007R.....	605, 754	BC172R.....	609, 751, 815
AA845R.....	1064	BB048R.....	300	BC008R.....	608, 751, 814	BC173R.....	609, 751, 815
AA846R.....	1064	BB052R.....	301	BC009R.....	608, 751, 814	BC175R.....	815
AA847R.....	1064	BB053R.....	301	BC010R.....	608, 751, 814	BC177R.....	332, 607, 752
AC468R.....	744	BB054R.....	300	BC011R.....	608, 751, 814	BC178R.....	333, 753
AC469R.....	744	BB057R.....	301	BC015R.....	25, 607, 752	BC179R.....	333, 753
AC470R.....	744	BB060R.....	300	BC020R.....	610, 816	BC180R.....	607, 752
AC471R.....	744	BB068R.....	302	BC021R.....	610, 816	BC181R.....	607, 752
AC472R.....	744	BB070R.....	302	BC022R.....	18	BC184R.....	759
AC473R.....	744	BB071R.....	302	BC023R.....	18	BC186R.....	608, 814
AC474R.....	744	BB074R.....	303	BC026R.....	26	BC187R.....	608, 814
AC475R.....	744	BB075R.....	303	BC027R.....	26	BC188R.....	335, 759
AC476R.....	744	BB077R.....	305	BC029R.....	26	BC189R.....	335, 759
AC477R.....	744	BB078R.....	303	BC034R.....	328	BC190R.....	749, 812
AC478R.....	744	BB079R.....	304	BC050R.....	813	BC191R.....	331
AC479R.....	744	BB080R.....	304	BC056R.....	748, 813	BC194R.....	609, 752, 815
AC480R.....	744	BB084R.....	304	BC057R.....	748, 813	BC195R.....	609, 752, 815
AC481R.....	744	BB085R.....	304	BC060R.....	748, 813	BC196R.....	331
AD110R.....	323	BB087R.....	305	BC061R.....	748, 813	BC210B.....	50, 350, 765
AD123R.....	795	BB089R.....	305	BC064R.....	24, 748, 813	BC210R.....	611, 760, 819
AD125R.....	795	BB175R.....	303	BC065R.....	24, 748, 813	BC211B.....	50, 350, 765
		BB176R.....	1299	BC100R.....	24, 813	BC211R.....	611, 760, 819
		BB177R.....	1299	BC101R.....	24, 813	BC211W.....	611, 761, 820
		BB178R.....	1299	BC106R.....	24, 813	BC211WB.....	50, 350, 765
				BC107R.....	24, 813	BC224R.....	29
						BC228R.....	29

CATALOG NUMBER	PAGE	CATALOG NUMBER	PAGE	CATALOG NUMBER	PAGE	CATALOG NUMBER	PAGE
BC234R.....	29	BC273WB.....	50, 350, 766	BC325R.....	4	BC547R.....	13
BC236R.....	29	BC274R.....	34	BC326R.....	4	BC554R.....	13
BC240R.....	31	BC275B.....	51, 351	BC327R.....	4	BC555R.....	13
BC241R.....	31	BC275R.....	34	BC328R.....	4	BC557R.....	13
BC242R.....	31	BC275W.....	38, 347	BC330R.....	4	BC558R.....	32, 345, 1207
BC243R.....	31	BC275WB.....	51, 351	BC341R.....	2	BC559R.....	32, 345, 1207
BC245R.....	343	BC276R.....	34	BC343R.....	2	BC560R.....	12
BC250R.....	31	BC277B.....	51, 351	BC344R.....	2	BC561R.....	12
BC251R.....	31	BC277R.....	34	BC345R.....	2	BC562R.....	13
BC252B.....	49, 349	BC277W.....	38, 347	BC346R.....	2	BC563R.....	13
BC252R.....	31	BC277WB.....	51, 351	BC374R.....	2	BC564R.....	13
BC253B.....	49, 349	BC279B.....	52, 352	BC403R.....	4	BC565R.....	13
BC253R.....	31	BC279R.....	35	BC404R.....	4	BC566R.....	16
BC253W.....	37	BC279W.....	39, 347	BC411R.....	6	BC567R.....	12
BC253WB.....	49, 349	BC279WB.....	52, 352	BC413R.....	6	BC568R.....	12
BC256R.....	612, 819	BC281B.....	52, 352	BC414R.....	6	BC569R.....	16
BC257B.....	613, 765	BC281R.....	35	BC415R.....	6	BC570R.....	16
BC257R.....	612, 819	BC281W.....	39, 347	BC416R.....	6	BC572R.....	16
BC257W.....	820	BC281WB.....	52, 352	BC417R.....	6	BC573R.....	16
BC257WB.....	613, 765	BC282R.....	35	BC421R.....	5	BC575R.....	16
BC258R.....	35, 344	BC283B.....	50, 350	BC423R.....	5	BC576R.....	16
BC259B.....	613, 765	BC283R.....	36	BC424R.....	5	BC577R.....	16
BC259R.....	35, 344	BC283WB.....	50, 350	BC425R.....	5	BC578R.....	16
BC259W.....	37, 346, 762	BC284B.....	49, 349	BC426R.....	5	BC579R.....	16
BC259WB.....	613, 765	BC284R.....	30	BC428R.....	5	BC580R.....	11
BC260R.....	33, 344	BC284W.....	40	BC441R.....	3	BC581R.....	11
BC261B.....	51, 351, 766	BC284WB.....	49, 349	BC443R.....	3	BC584R.....	11
BC261R.....	33, 344	BC285R.....	35	BC444R.....	3	BC585R.....	11
BC261W.....	38, 346, 762	BC287R.....	34, 344	BC445R.....	3	BC587R.....	11
BC261WB.....	51, 351, 766	BC287W.....	38, 347, 1209	BC464R.....	2	BC588R.....	11
BC262R.....	33, 344	BC289R.....	35	BC466R.....	14, 328	BC589R.....	11
BC263B.....	51, 351, 766	BC290R.....	1207	BC467R.....	14, 328	BC590R.....	15
BC263R.....	33, 344	BC290W.....	1209	BC474R.....	2	BC591R.....	15
BC263W.....	38, 346, 762	BC291R.....	1207	BC496R.....	3	BC592R.....	15
BC263WB.....	51, 351, 766	BC291W.....	1209	BC515R.....	341	BC594R.....	14
BC265B.....	51, 351	BC293R.....	1207	BC516R.....	341	BC595R.....	885
BC265R.....	33, 344	BC294W.....	41, 348	BC517R.....	341	BC597R.....	335
BC265W.....	38, 346	BC295W.....	41, 348	BC518R.....	341	BC599R.....	335
BC265WB.....	51, 351	BC296W.....	41, 348	BC519R.....	341	BC600R.....	18
BC266R.....	35	BC297W.....	41, 348	BC521R.....	887	BC601R.....	18
BC267B.....	51, 351	BC298W.....	41, 348	BC522R.....	341	BC602R.....	18
BC267R.....	35	BC303R.....	3	BC523R.....	341	BC603R.....	18
BC267W.....	39, 347	BC304R.....	3	BC524R.....	341	BC604R.....	18
BC267WB.....	51, 351	BC313R.....	6	BC525R.....	341	BC605R.....	18
BC270R.....	34	BC314R.....	6	BC526R.....	341	BC606R.....	18
BC271B.....	51, 351, 766	BC315R.....	6	BC531R.....	341	BC607R.....	18
BC271R.....	34	BC316R.....	6	BC532R.....	341	BC610R.....	706
BC271W.....	38, 347, 762	BC317R.....	6	BC533R.....	341	BC611R.....	19
BC271WB.....	51, 351, 766	BC320R.....	4	BC534R.....	341	BC612R.....	19
BC273B.....	50, 350, 766	BC321R.....	4	BC535R.....	341	BC613R.....	19
BC273R.....	36	BC323R.....	4	BC544R.....	13	BC614R.....	19
BC273W.....	39, 346	BC324R.....	4	BC545R.....	13	BC615R.....	19

Numerical Index

BC - BD

CATALOG NUMBER	PAGE	CATALOG NUMBER	PAGE	CATALOG NUMBER	PAGE	CATALOG NUMBER	PAGE
BC616R.....	19	BC690R.....	1168	BC909R.....	43, 763	BD037R.....	80
BC617R.....	21	BC691R.....	1168	BC911R.....	44, 333, 753	BD043R.....	79
BC618R.....	19	BC692R.....	1168	BC915R.....	44, 333, 753	BD045R.....	79
BC619R.....	19	BC693R.....	1168	BC916R.....	44	BD047R.....	79
BC620R.....	20	BC694R.....	1168	BC917R.....	44	BD049R.....	79
BC621R.....	22	BC695R.....	1168	BC919R.....	44, 333, 753	BD050R.....	79
BC622R.....	22	BC696R.....	1168	BC920R.....	45, 764	BD051R.....	79
BC623R.....	22	BC702R.....	1204	BC921R.....	45, 764	BD052R.....	79
BC625R.....	20	BC703R.....	1204	BC922R.....	46	BD053R.....	79
BC627R.....	23	BC704R.....	1204	BC924R.....	45, 328	BD077R.....	79
BC628R.....	17, 753	BC708R.....	1202	BC925R.....	45, 328	BD151R.....	102
BC629R.....	329	BC715R.....	1300	BC926R.....	45	BD154R.....	103, 374
BC630R.....	17	BC721R.....	1202	BC927R.....	45	BD156R.....	103
BC631R.....	17	BC723R.....	1202	BC929R.....	46	BD157R.....	103
BC633R.....	17	BC731R.....	1202	BC930R.....	47	BD158R.....	103
BC634R.....	17	BC741R.....	1202	BC931R.....	47	BD159R.....	103
BC635R.....	17	BC743R.....	1202	BC933R.....	45, 764	BD160R.....	104
BC636R.....	329	BC746R.....	1203	BC934R.....	47	BD164R.....	105
BC638R.....	331	BC748R.....	1203	BC935R.....	47	BD165R.....	105
BC639R.....	331	BC760R.....	1205	BC936R.....	47, 334	BD166R.....	105
BC641R.....	330	BC761R.....	1206	BC937R.....	47, 334	BD168R.....	105
BC643R.....	331	BC762R.....	1206	BC938R.....	46	BD171R.....	105
BC644R.....	330	BC774R.....	21	BC939R.....	614, 764	BD173R.....	105
BC645R.....	330	BC796R.....	1210	BC945R.....	48, 334, 756	BD190R.....	373
BC646R.....	335	BC797R.....	1210	BC947R.....	48, 334, 756	BD191R.....	373
BC647R.....	337	BC801R.....	7, 757	BC949R.....	48, 334, 756	BD192R.....	375
BC648R.....	337	BC802R.....	7, 757	BC951R.....	48, 334, 756	BD193R.....	375
BC649R.....	337	BC803R.....	7, 757	BC953R.....	48, 334, 756	BD194R.....	375
BC650R.....	337	BC804R.....	14	BC957R.....	48, 336	BD195R.....	373
BC651R.....	337	BC805R.....	7, 758	BC958R.....	48, 336	BD196R.....	375
BC652R.....	336	BC806R.....	14	BC959R.....	48, 336	BD197R.....	373
BC653R.....	338	BC815R.....	23	BC970R.....	10, 880	BD198R.....	104
BC654R.....	338	BC846R.....	7	BC971R.....	10, 880	BD200R.....	375
BC655R.....	336	BC847R.....	7	BC973R.....	10, 880	BD201R.....	375
BC656R.....	339	BC848R.....	8, 882	BC975R.....	10, 880	BD210R.....	80
BC657R.....	339	BC849R.....	8, 882	BC977R.....	10, 880	BD215R.....	89
BC660R.....	329	BC860R.....	8, 882	BC978R.....	10, 880	BD216R.....	89
BC662R.....	338	BC861R.....	8, 882	BC979R.....	10, 880	BD220R.....	89
BC663R.....	338	BC862R.....	8, 882	BC980R.....	10, 880	BD221T.....	379
BC664R.....	338	BC863R.....	8, 882	BC981R.....	10, 880	BD222R.....	90
BC669R.....	339	BC876R.....	9, 881	BC983R.....	10, 880	BD223R.....	89
BC670R.....	340	BC881R.....	10, 880	BC985R.....	10, 880	BD225R.....	89
BC672R.....	758	BC885R.....	10, 880	BC987R.....	10, 880	BD227T.....	380
BC676R.....	338	BC888R.....	885	BC988R.....	10, 880	BD228R.....	93, 371
BC677R.....	338	BC890R.....	10	BC989R.....	10, 880	BD229R.....	93, 371
BC678R.....	339	BC900R.....	42			BD230R.....	93, 371
BC679R.....	339	BC901R.....	42	BD023R.....	80	BD231R.....	95
BC685R.....	1168	BC903R.....	42, 763	BD025R.....	80	BD232R.....	95
BC686R.....	1168	BC904R.....	42, 614	BD027R.....	80	BD236R.....	93
BC687R.....	1168	BC905R.....	42, 614	BD029R.....	80	BD238R.....	94
BC688R.....	1168	BC906R.....	43, 614	BD033R.....	80	BD239R.....	94
BC689R.....	1168	BC907R.....	43, 614	BD035R.....	80	BD240R.....	94

CATALOG NUMBER	PAGE	CATALOG NUMBER	PAGE	CATALOG NUMBER	PAGE	CATALOG NUMBER	PAGE
BD243R	94	BD540R	81	BD750R	85, 371	BF062R	142
BD246R	94	BD541R	81	BD755R	84	BF063R	142
BD250R	100	BD542R	81	BD760R	84	BF065R	142
BD257R	93	BD543R	81	BD761R	84	BF076R	1214
BD260R	776	BD547R	81	BD765R	1079	BF077R	1214
BD261R	776	BD549R	81	BD766R	1079	BF078R	142
BD264R	373	BD553R	82	BD768R	1080	BF112R	145
BD301R	95	BD555R	82	BD770R	101	BF113R	145
BD302R	95	BD557R	82	BD801R	372	BF116R	143
BD303R	95	BD559R	82	BD802R	372	BF118R	143
BD304R	95	BD560R	82	BD835R	1078	BF120R	145
BD305R	95	BD561R	82	BD836R	1078	BF121R	145
BD311R	95	BD562R	82	BD837R	1078	BF122R	145
BD312R	95	BD563R	82	BD840R	1078	BF123R	145
BD313R	95	BD575R	81	BD841R	1078	BF135R	146
BD314R	95	BD577R	81	BD845R	1078	BF136R	146
BD315R	95	BD579R	81	BD846R	1078	BF303R	777
BD320R	833	BD580R	81	BD850R	1078	BF306R	777
BD321R	833	BD581R	81	BD851R	1078	BF307R	778
BD329R	773	BD587R	81	BD870R	619	BF309R	106
BD330R	96, 773, 832	BD589R	81	BD876R	87, 619	BF310R	106
BD331R	96, 832	BD591R	81	BD878R	86, 618	BF311R	106
BD333R	96, 832	BD610R	89	BD879R	86, 618	BF315R	778
BD335R	96, 832	BD611R	89	BD880R	87, 618	BF316R	778
BD336R	774, 833	BD657T	380	BD883R	86, 618	BF324R	778
BD337R	774, 833	BD660R	97	BD885R	87, 619	BF326R	778
BD338R	373, 774	BD661R	93	BD886R	87, 619	BF407R	186
BD340R	774	BD662R	92, 371	BD887R	88	BF426R	186
BD345R	774	BD663R	92, 371	BD888R	1079	BF431R	186
BD500R	96	BD664R	92, 371	BD900R	88, 620	BF432R	186
BD501R	96	BD665R	89	BD902R	88, 620	BF433R	186
BD502R	96	BD666R	89	BD904R	88, 620	BF436R	187
BD505R	773, 836	BD667R	89	BD910R	88, 620	BF437R	187
BD506R	90	BD669R	97	BD911R	88, 620	BF444R	187
BD507R	90	BD670R	97	BD952R	781	BF448R	187
BD508R	90	BD671R	97	BD963R	781	BF458R	188
BD509R	775	BD672R	97	BD964R	781	BF459R	188
BD510R	91	BD679R	97	BD965R	781	BF460R	188
BD511R	90	BD690R	83	BD980R	101	BF461R	189
BD512R	90	BD692R	83	BD992R	781	BF463R	189
BD513R	90	BD693R	83	BD993R	781	BF464R	188
BD514T	379	BD700R	91	BD995R	781		
BD516T	379	BD701R	91			BH011R	482
BD520R	91	BD702R	91	BF004R	141	BH012R	482
BD521R	90	BD710R	372	BF006R	141	BH013R	482
BD522R	92	BD711R	372	BF008R	141	BH014R	482
BD523R	92	BD712R	372	BF046R	141	BH015R	482
BD527R	81	BD715T	380	BF047R	141	BH016R	482
BD533R	81	BD725R	84	BF056R	1213	BH017R	482
BD535R	81	BD726R	84	BF057R	1213	BH018R	482
BD537R	81	BD727R	84	BF058R	1213	BH020R	482
BD539R	81	BD733R	83	BF059R	1213	BH021R	482

Numerical Index

BH - BJ

CATALOG NUMBER	PAGE	CATALOG NUMBER	PAGE	CATALOG NUMBER	PAGE	CATALOG NUMBER	PAGE
BH022R	482	BH202R	165	BH473R	154	BJ029R	1301
BH023R	482	BH203R	165	BH474R	154	BJ031R	175
BH026R	482	BH205R	165	BH475R	154	BJ032R	175
BH027R	482	BH206R	170	BH614R	155	BJ033R	175
BH030R	483	BH207R	170	BH615R	155	BJ034R	175
BH031R	483	BH209R	170	BH618R	156	BJ035R	175
BH032R	485	BH210R	163	BH619R	156	BJ037R	172, 392
BH034R	485	BH211R	163	BH630R	155	BJ038R	172, 392
BH100R	782	BH212R	165	BH631R	155	BJ039R	172, 392
BH104R	162	BH213R	165	BH642R	157	BJ047R	178
BH105R	162	BH214R	163	BH643R	157	BJ048R	178
BH106R	163	BH215R	163	BH644R	157	BJ050R	179
BH108R	162	BH216R	170	BH645R	157	BJ051R	183
BH109R	162	BH217R	170	BH646R	157	BJ052R	179
BH110R	163	BH224R	392	BH647R	157	BJ055R	182
BH111R	163	BH225R	392	BH648R	157	BJ057R	173
BH114R	162	BH226R	393	BH649R	157	BJ058R	173
BH115R	162	BH228R	171	BH650R	157	BJ059R	173
BH118R	162	BH229R	171	BH651R	157	BJ060R	180
BH119R	162	BH230R	171	BH652R	157	BJ061R	181
BH120R	163	BH231R	171	BH653R	157	BJ062R	181
BH121R	163	BH233R	393	BH654R	157	BJ070R	184
BH130R	165	BH234R	392	BH655R	157	BJ072R	183
BH131R	165	BH332R	151	BH800R	159	BJ073R	181
BH134R	166	BH333R	151	BH801R	159	BJ075R	185
BH135R	166	BH334R	151	BH804R	159	BJ080R	176
BH139R	782	BH335R	151	BH805R	159	BJ081R	176
BH140R	166	BH336R	151	BH831R	160	BJ082R	176
BH141R	166	BH337R	151	BH833R	160	BJ083R	176
BH143R	782	BH338R	151	BH902R	116	BJ086R	176
BH144R	167	BH339R	151	BH906R	147, 718	BJ090R	176
BH145R	167	BH410R	152	BH908R	147	BJ091R	176
BH150R	166	BH412R	151	BH951R	160, 715	BJ096R	176
BH151R	166	BH413R	151	BH952R	160, 715	BJ100R	172
BH154R	167	BH414R	151	BH957R	161, 713	BJ102R	172
BH155R	167	BH415R	151	BH959R	161, 713	BJ103R	172
BH160R	168	BH422R	152	BH961R	161, 713	BJ104R	172
BH161R	168	BH424R	152	BH963R	161, 713	BJ106R	172
BH164R	169	BH425R	152			BJ110R	1301
BH165R	169	BH442R	153	BJ002R	164	BJ130R	178
BH166R	167	BH443R	153	BJ008R	174	BJ131R	178
BH167R	167	BH444R	153	BJ011R	182	BJ132R	178
BH170R	168	BH445R	153	BJ012R	182	BJ500R	1251
BH171R	168	BH446R	153	BJ013R	174	BJ501R	1251
BH176R	167	BH447R	153	BJ014R	174	BJ510R	1251
BH177R	167	BH448R	153	BJ020R	175	BJ511R	1251
BH187R	164	BH449R	153	BJ021R	175	BJ520R	1252
BH189R	164	BH450R	153	BJ022R	175	BJ521R	1252
BH197R	169	BH451R	153	BJ023R	175	BJ522R	1252
BH199R	169, 714	BH470R	154	BJ024R	175	BJ524R	1251
BH200R	170, 714	BH471R	154	BJ025R	175	BJ527R	1254
BH201R	170, 714	BH472R	154	BJ026R	175	BJ530R	1254

CATALOG NUMBER	PAGE	CATALOG NUMBER	PAGE	CATALOG NUMBER	PAGE	CATALOG NUMBER	PAGE
BJ531R.....	1254	BM045R.....	66, 369	BM220R.....	55	BN003R.....	293
BJ532R.....	1254	BM046R.....	66, 369	BM224R.....	55	BN004R.....	293
BJ550R.....	1255	BM047R.....	66, 369	BM235R.....	56	BN006R.....	293
BJ551R.....	1255	BM051R.....	367	BM236R.....	56	BN010R.....	293
BJ552R.....	1255	BM052R.....	367	BM237R.....	56	BN012R.....	294
BJ553R.....	1255	BM054R.....	66, 369	BM245R.....	56	BN015R.....	294
BJ574R.....	1256	BM055R.....	66, 369	BM247R.....	56	BN020R.....	294
BJ576R.....	1256	BM056R.....	66, 369	BM249R.....	56	BN021R.....	295
BJ579R.....	1257	BM057R.....	66, 369	BM255R.....	56	BN022R.....	295
BJ581R.....	1257	BM058R.....	66, 369	BM259R.....	56, 1212	BN023R.....	295
		BM063R.....	65, 368	BM270R.....	57	BN024R.....	295
BL907R.....	76	BM064R.....	65, 368	BM272R.....	57	BN034R.....	296
BL930R.....	76	BM065R.....	68	BM275R.....	57	BN036R.....	296
BL931R.....	76	BM066R.....	68	BM290R.....	58	BN040R.....	296
BL933R.....	76	BM067R.....	68	BM291R.....	58	BN054R.....	296
BL941R.....	76	BM068R.....	68	BM299R.....	58	BN063R.....	296
		BM069R.....	68	BM301R.....	367	BN064R.....	296
BM001R.....	360, 769	BM070R.....	68	BM302R.....	367	BN066R.....	296
BM002R.....	360, 769	BM074R.....	66, 369	BM320R.....	59	BN068R.....	296
BM004R.....	360, 769	BM075R.....	66, 369	BM325R.....	367	BN070R.....	296
BM005R.....	360, 769	BM076R.....	66, 369	BM327R.....	367	BN090R.....	297
BM008R.....	59	BM077R.....	69	BM328R.....	367	BN095.....	297
BM009R.....	60	BM078R.....	69	BM385T.....	367	BN096.....	297
BM010R.....	60	BM081R.....	71, 1212	BM386T.....	367	BN101R.....	297
BM011R.....	61	BM084R.....	71, 1212	BM387T.....	367	BN104R.....	297
BM012R.....	60	BM089R.....	71	BM560R.....	358, 829	BN113R.....	297
BM013R.....	62	BM090R.....	70	BM562R.....	358, 829	BN114R.....	297
BM014R.....	61	BM092R.....	72	BM563R.....	357	BN116R.....	297
BM015R.....	61	BM095R.....	72, 370	BM564R.....	357	BN118R.....	297
BM016R.....	63, 771	BM096R.....	72, 370	BM711R.....	1298	BN120R.....	297
BM017R.....	63, 771	BM110R.....	73	BM712R.....	1298	BN125R.....	297
BM019R.....	63, 771	BM111R.....	73	BM713R.....	1298	BN134R.....	297
BM020R.....	62	BM112R.....	73	BM714R.....	1298	BN136R.....	297
BM021R.....	63, 771	BM124R.....	770	BM726R.....	1298	BN138R.....	297
BM022R.....	64	BM127R.....	770	BM727R.....	1298	BN140R.....	297
BM023R.....	62	BM128R.....	770	BM728R.....	1298	BN150R.....	297
BM024R.....	61	BM129R.....	771	BM729R.....	1298	BN170R.....	294
BM025R.....	64	BM149R.....	75	BM749R.....	77	BN452R.....	568
BM026R.....	64	BM151R.....	75	BM770R.....	78	BN457R.....	568
BM027R.....	64	BM154R.....	75	BM771R.....	78	BN460R.....	568
BM029R.....	63, 772	BM156R.....	75	BM781R.....	77	BN461R.....	568
BM030R.....	63, 771	BM158R.....	75	BM801R.....	78	BN465R.....	568
BM032R.....	65, 368	BM178R.....	888	BM802R.....	78	BN466R.....	568
BM033R.....	65, 368	BM200R.....	53	BM807R.....	77	BN467R.....	568
BM034R.....	65, 368	BM201R.....	53	BM809R.....	77		
BM035R.....	65, 368	BM202R.....	53	BM811R.....	77	BT004R.....	195
BM036R.....	65, 368	BM204R.....	53	BM813R.....	77	BT006R.....	194
BM037R.....	65, 368	BM205R.....	53	BM822R.....	77	BT007R.....	194
BM038R.....	65, 368	BM210R.....	54	BM824R.....	77	BT008R.....	194
BM040R.....	65, 368	BM215R.....	54	BM855R.....	78	BT010R.....	196
BM042R.....	69	BM218R.....	55			BT011R.....	198
BM044R.....	66, 369	BM219R.....	55			BT012R.....	197

Numerical Index

BT

CATALOG NUMBER	PAGE	CATALOG NUMBER	PAGE	CATALOG NUMBER	PAGE	CATALOG NUMBER	PAGE
BT020R	196	BT185R	204	BT266R	209	BT467R	219
BT021R	196	BT187R	195	BT272R	209	BT468R	219
BT022R	197	BT190R	204	BT273R	209	BT469R	219
BT025R	198	BT193R	204	BT274R	209	BT470R	219
BT026R	198	BT194R	204	BT276R	209	BT471R	219
BT029R	199	BT195R	204	BT278R	209	BT472R	219
BT030R	200	BT196R	204	BT279R	209	BT475R	220
BT031R	200	BT197R	204	BT284R	210	BT476R	220
BT032R	200	BT198R	204	BT285R	210	BT477R	220
BT033R	200	BT200R	205	BT286R	210	BT478R	220
BT034R	199	BT202R	205	BT287R	210	BT479R	221
BT035R	199	BT210R	1318	BT290R	211	BT481R	222
BT036R	199	BT211R	1318	BT293R	211	BT482R	222
BT040R	201	BT212R	1318	BT294R	211	BT483R	222
BT041R	201	BT213R	1318	BT296R	211	BT484R	222
BT075R	193	BT214R	1318	BT311R	212	BT485R	922
BT080R	506, 1121	BT215R	1318	BT315R	212	BT486R	922
BT082R	506, 1121	BT216R	1318	BT316R	212	BT487R	922
BT083R	506, 1121	BT217R	1318	BT351R	212	BT501R	920
BT084R	506, 1121	BT221R	206	BT352R	212	BT502R	920
BT088R	1120	BT222R	206	BT353R	212	BT503R	919
BT089R	1120	BT223R	206	BT354R	213	BT504R	919
BT090R	1120	BT224R	206	BT356R	213	BT505R	919
BT091R	1120	BT225R	206	BT357R	213	BT514R	223
BT100R	193	BT227R	206	BT358R	213	BT521R	514
BT103R	720	BT228R	206	BT359R	213	BT522R	514
BT106R	720	BT229R	206	BT361R	213	BT523R	514
BT107R	720	BT230R	206	BT363R	213	BT531R	515
BT111R	202	BT232R	940	BT364R	213	BT551R	224
BT112R	202	BT234R	940	BT365R	213	BT552R	224
BT113R	202	BT238R	940	BT404R	214	BT553R	226
BT114R	202	BT239R	940	BT405R	214	BT559R	516
BT116R	202	BT240R	207, 941	BT406R	214	BT560R	516
BT117R	202	BT241R	207, 941	BT408R	214	BT561R	517
BT118R	202	BT242R	207	BT419R	917	BT594R	227
BT119R	202	BT243R	207	BT420R	917	BT595R	227
BT121R	202	BT244R	207	BT421R	921	BT596R	227
BT122R	202	BT246R	207	BT422R	921	BT597R	227
BT123R	202	BT248R	207	BT423R	921	BT600R	228
BT124R	202	BT252R	207	BT424R	921	BT601R	229
BT126R	202	BT253R	207	BT425R	921	BT602R	229
BT127R	202	BT254R	207	BT430R	918	BT603R	229
BT128R	202	BT256R	207	BT442R	216	BT604R	230
BT129R	202	BT257R	207	BT446R	216	BT605R	231
BT161R	193	BT258R	207	BT450R	219	BT606R	228
BT166R	193	BT259R	207	BT451R	219	BT607R	231
BT167R	193	BT260R	207	BT461R	217	BT608R	232
BT172R	203	BT261R	207	BT462R	217	BT611R	233
BT179R	203	BT262R	209	BT463R	217	BT613R	233
BT182R	203	BT263R	209	BT464R	218	BT614R	233
BT183R	203	BT264R	209	BT465R	218	BT615R	233
BT184R	204	BT265R	207	BT466R	219	BT626R	240

CATALOG NUMBER	PAGE	CATALOG NUMBER	PAGE	CATALOG NUMBER	PAGE	CATALOG NUMBER	PAGE
BT667R	236	BT948R	787	BV208R	278	BV617R	251
BT669R	236	BT949R	787	BV209R	278	BV618R	251
BT670R	238	BT951R	787	BV248R	942	BV621R	248
BT672R	238	BT958R	787	BV250R	942	BV622R	248
BT674R	239	BT964R	787	BV251R	943	BV624R	248
BT680R	1301	BT966R	788	BV252R	942	BV626R	248
BT681R	1301			BV254R	943	BV628R	248
BT682R	1301	BV001R	272, 791	BV258R	944	BV632R	248
BT683R	1301	BV002R	272, 791	BV271R	944	BV634R	248
BT708R	241	BV003R	272, 791	BV272R	944	BV636R	248
BT709R	241	BV005R	272, 791	BV273R	945	BV638R	248
BT710R	241	BV006R	273, 792	BV276R	945	BV646R	253
BT711R	241	BV007R	273, 792	BV296R	950	BV648R	253
BT712R	241	BV008R	274, 791	BV297R	951	BV649R	253
BT713R	241	BV010R	274, 793	BV298R	951	BV650R	253
BT714R	241	BV011R	274, 793	BV299R	950	BV653R	254
BT715R	241	BV013R	847	BV399R	244	BV654R	254
BT750R	235	BV014R	272, 508	BV500R	245	BV655R	254
BT751R	235	BV015R	274, 791	BV502R	245	BV656R	254
BT752R	235	BV021R	508	BV505R	246	BV657R	254
BT755R	235	BV022R	508	BV506R	246	BV658R	254
BT756R	235	BV023R	508	BV510R	952	BV659R	254
BT758R	235	BV024R	508	BV512R	243	BV840R	1302
BT761R	235	BV028R	793	BV516R	952	BV849R	1302
BT762R	235	BV030R	556, 657	BV517R	952	BV906R	284
BT763R	235	BV032R	556, 657	BV518R	952	BV907R	285
BT773R	242	BV033R	556, 657	BV519R	952	BV921R	1302
BT774R	242	BV066R	276	BV520R	244	BV922R	1302
BT775R	242	BV067R	276	BV530R	244	BV924R	1302
BT776R	242	BV068R	276	BV551R	244	BV925R	1302
BT777R	242	BV070R	276	BV575R	1318	BV926R	1302
BT901R	786	BV071R	276	BV576R	1318	BV927R	1302
BT902R	786	BV072R	276	BV577R	1318	BV928R	1314
BT904R	786	BV073R	275	BV578R	1318	BV929R	1302
BT906R	786	BV074R	275	BV580R	1318	BV993R	282
BT911R	786	BV075R	275	BV581R	284	BV996R	281, 1261
BT912R	786	BV076R	277	BV582R	284	BV997R	281, 1261
BT913R	786	BV077R	277	BV583R	284	BV998R	282
BT916R	786	BV078R	556	BV584R	284	BV999R	282
BT917R	786	BV085R	277	BV585R	284		
BT918R	786	BV086R	279	BV586R	284	DF112R	801
BT921R	786	BV087R	279	BV589R	284	DF114R	693, 989
BT922R	786	BV088R	279	BV601R	246		
BT923R	786	BV094R	277	BV602R	246	DO208R	707, 760
BT926R	786	BV101R	276	BV605R	247	DO209R	707, 760
BT927R	786	BV104R	275	BV606R	247	DO250R	612, 760
BT928R	786	BV112R	280	BV608R	247	DO438R	215
BT940R	787	BV120R	283	BV609R	247	DO439R	215
BT943R	787	BV200R	278	BV610R	247	DO543R	804
BT944R	787	BV201R	278	BV611R	247	DO552R	804
BT945R	787	BV206R	278	BV615R	248	DO553R	804
BT946R	787	BV207R	278	BV616R	248	DO711R	799

Numerical Index

DO - EF

CATALOG NUMBER	PAGE	CATALOG NUMBER	PAGE	CATALOG NUMBER	PAGE	CATALOG NUMBER	PAGE
DO715R	800	EA117R	120	EA882R	289	EB234R	130
DO773R	805	EA120R	118	EA883R	289	EB244R	133, 1309
DO810R	803	EA121R	118	EA887R	289	EB246R	133, 1309
DO811R	803	EA124R	119	EA890R	298		
DO812R	803	EA125R	119	EA903R	149	EF001R	1303
		EA126R	118	EA943R	150	EF002R	1303
DP031R	805	EA127R	118	EA990R	290	EF010R	1304
DP501R	806	EA130R	119	EA991R	290	EF011R	1304
DP505R	806	EA131R	119	EA992208	290	EF012R	1304
DP520R	806	EA140R	120	EA992R	290	EF015R	1305
DP530R	806	EA141R	120	EA993	290	EF016R	1305
DP551R	23	EA145R	120			EF030R	1306
DP552R	30, 343, 807	EA146R	120	EB001R	127	EF047R	131, 1307
DP560R	807	EA150R	121	EB003R	127	EF048R	131, 1307
DP561R	807	EA151R	121	EB004R	128	EF051R	132, 1309
DP563R	807	EA152R	121	EB008R	127	EF052R	132, 1309
DP569R	807	EA155R	121	EB011R	128	EF053R	132, 1309
		EA156R	121	EB012R	128	EF054R	132, 1309
EA010R	107	EA170R	122	EB061R	292	EF055R	133, 1308
EA012R	107	EA171R	122	EB062R	292	EF056R	133, 1308
EA015R	107	EA202R	134	EB063R	292	EF070R	1306
EA016R	107	EA203R	134	EB064R	292	EF155R	1310
EA017R	107	EA204R	134	EB065R	292	EF163R	1310
EA018R	107	EA205R	134	EB066R	292	EF164R	1310
EA020R	108	EA206R	134	EB067R	292	EF167R	1300
EA022R	114	EA207R	134	EB068R	292	EF195R	1311
EA023R	114	EA210R	135	EB069R	292	EF306C	1319
EA025R	109	EA211R	135	EB070R	292	EF308C	1319
EA026R	109	EA212R	136	EB071R	292	EF310C	1319
EA030R	112	EA213R	136	EB072R	292	EF312C	1319
EA031R	112	EA216R	135	EB073R	292	EF314C	1319
EA032R	112	EA217R	135	EB074R	292	EF316C	1319
EA037R	116	EA222R	136	EB101R	299	EF318C	1319
EA039R	115	EA223R	136	EB102R	299	EF400R	1312
EA040R	115	EA240R	136	EB103R	299	EF401R	1312
EA041R	116	EA305R	123	EB111R	299	EF492R	1319
EA042R	116	EA306R	123	EB112R	299	EF638R	1320
EA050R	113	EA309R	123	EB113R	299	EF639R	1320
EA052R	113	EA323R	126	EB114R	299	EF640R	1320
EA061R	115	EA331R	124	EB168R	293	EF641R	1320
EA062R	115	EA332R	124	EB169R	293	EF642R	1320
EA092R	110	EA334R	124	EB170R	293	EF643R	1320
EA095R	110	EA365R	131	EB171R	293	EF644R	1320
EA096R	110	EA397R	125	EB172R	293	EF645R	1320
EA097R	110	EA450R	123	EB173R	293	EF646R	1320
EA099R	110	EA466R	125	EB174R	293	EF647R	1320
EA100R	110	EA800R	285	EB175R	293	EF648R	1320
EA101R	110	EA820R	286	EB220R	129	EF649R	1320
EA106R	117	EA821R	286	EB221R	129	EF650R	1320
EA107R	117	EA831R	286	EB231R	130	EF651R	1320
EA114R	117	EA843R	287	EB232R	130	EF652R	1320
EA116R	120	EA880R	287	EB233R	130	EF653R	1320

CATALOG NUMBER	PAGE	CATALOG NUMBER	PAGE	CATALOG NUMBER	PAGE	CATALOG NUMBER	PAGE
EF654R.....	1320	EL427R.....	1267	EL739R.....	1275	EM140R.....	1283
EF655R.....	1320	EL428R.....	1267	EL740R.....	1277	EM141R.....	1283
EF656R.....	1320	EL440R.....	1269	EL741R.....	1277	EM142R.....	1283
EF657R.....	1320	EL441R.....	1269	EL742R.....	1277	EM143R.....	1283
EF658R.....	1320	EL442R.....	1269	EL743R.....	1277	EM144R.....	1283
EF659R.....	1320	EL443R.....	1269	EL744R.....	1277	EM145R.....	1283
EF660R.....	1320	EL444R.....	1269	EL745R.....	1277	EM146R.....	1283
EF800R.....	1321	EL445R.....	1269	EL746R.....	1277	EM147R.....	1283
EF801R.....	1321	EL446R.....	1269	EL747R.....	1277	EM193R.....	1284
EF802R.....	1321	EL447R.....	1269	EL859R.....	1277	EM194R.....	1284
EF803R.....	1321	EL448R.....	1269	EL860R.....	1277	EM231R.....	1284
EF804R.....	1321	EL450R.....	1268	EL865R.....	1273	EM232R.....	1284
EF805R.....	1321	EL451R.....	1268	EL868R.....	1278	EM233R.....	1284
EF806R.....	1321	EL452R.....	1268	EL870R.....	1280	EM234R.....	1284
EF807R.....	1321	EL453R.....	1268	EL872R.....	1281	EM235R.....	1284
EF808R.....	1321	EL454R.....	1268	EL873R.....	1281	EM236R.....	1284
EF809R.....	1321	EL455R.....	1268			EM237R.....	1284
EF810R.....	1321	EL457R.....	1268	EM101R.....	1283	EM238R.....	1284
EF811R.....	1321	EL458R.....	1268	EM102R.....	1283	EM239R.....	1284
EF812R.....	1321	EL480R.....	1270	EM103R.....	1283	EM244R.....	1284
EF813R.....	1321	EL481R.....	1270	EM104R.....	1283	EM270R.....	1285
EF814R.....	1321	EL578R.....	1272	EM105R.....	1283	EM271R.....	1285
EF815R.....	1321	EL579R.....	1272	EM106R.....	1283	EM272R.....	1285
EF816R.....	1321	EL581R.....	1272	EM107R.....	1283	EM273R.....	1285
EF928R.....	1311	EL627R.....	1273	EM108R.....	1283	EM274R.....	1285
EF965R.....	1313	EL628R.....	1273	EM109R.....	1283	EM275R.....	1285
EF966R.....	1313	EL629R.....	1273	EM110R.....	1283	EM276R.....	1285
EF967R.....	1313	EL631R.....	1274	EM111R.....	1283	EM277R.....	1285
		EL632R.....	1274	EM112R.....	1283	EM278R.....	1285
EL011R.....	1263	EL633R.....	1274	EM113R.....	1283	EM710R.....	1282
EL040R.....	1263	EL634R.....	1274	EM114R.....	1283	EM711R.....	1282
EL042R.....	1263	EL635R.....	1274	EM115R.....	1283		
EL043R.....	1263	EL636R.....	1274	EM116R.....	1283	E0005R.....	299
EL044R.....	1263	EL637R.....	1274	EM117R.....	1283	E0010R.....	1286
EL180R.....	1264	EL638R.....	1274	EM118R.....	1283	E0012R.....	1286
EL181R.....	1264	EL639R.....	1274	EM119R.....	1283	E0015R.....	1286
EL182R.....	1264	EL642R.....	1274	EM120R.....	1283	E0016R.....	1287
EL183R.....	1264	EL644R.....	1274	EM121R.....	1283	E0020.....	1287
EL192R.....	1265	EL693R.....	1274	EM122R.....	1283	E0030R.....	1287
EL193R.....	1265	EL694R.....	1274	EM123R.....	1283	E0060R.....	1214
EL194R.....	1266	EL695R.....	1274	EM124R.....	1283	E0061R.....	1214
EL195R.....	1266	EL697R.....	1274	EM125R.....	1283	E0075R.....	1215
EL196R.....	1266	EL698R.....	1274	EM126R.....	1283	E0077R.....	1215
EL407R.....	1271	EL700R.....	1274	EM131R.....	1283	E0080R.....	1215
EL408R.....	1271	EL702R.....	1274	EM132R.....	1283	E0082R.....	1215
EL409R.....	1271	EL703R.....	1274	EM133R.....	1283	E0085R.....	1216
EL420R.....	1267	EL704R.....	1274	EM134R.....	1283	E0105R.....	1217
EL421R.....	1267	EL705R.....	1274	EM135R.....	1283	E0106R.....	1216
EL422R.....	1267	EL707R.....	1274	EM136R.....	1283	E0108R.....	1218
EL423R.....	1267	EL708R.....	1274	EM137R.....	1283	E0110R.....	1218
EL425R.....	1267	EL736R.....	1275	EM138R.....	1283	E0125R.....	1220
EL426R.....	1267	EL738R.....	1275	EM139R.....	1283	E0130R.....	1220

Numerical Index

EO - FB

CATALOG NUMBER	PAGE	CATALOG NUMBER	PAGE	CATALOG NUMBER	PAGE	CATALOG NUMBER	PAGE
EO140R.....	1221	ER222R.....	1289	ER526R.....	1291	FA038R.....	1132
EO150R.....	1219	ER223R.....	1289	ER580R.....	1293	FA039R.....	1132
EO151R.....	1219	ER224R.....	1289	ER585R.....	1293	FA040R.....	1133
EO163R.....	1219	ER225R.....	1289	ER602R.....	1294	FA041R.....	1133
EO164R.....	1222	ER226R.....	1289	ER611R.....	1289	FA042R.....	1133
EO165R.....	1222	ER227R.....	1289	ER612R.....	1289	FA043R.....	1133
EO166R.....	1223	ER228R.....	1289	ER621R.....	1294	FA044R.....	1133
EO180R.....	1223	ER229R.....	1289	ER623R.....	1294	FA045R.....	1134
EO202R.....	1224	ER230R.....	1289	ER626R.....	1294	FA046R.....	1134
EO216R.....	1224	ER241R.....	1289	ER627R.....	1294	FA047R.....	1134
EO218R.....	1224	ER242R.....	1289	ER628R.....	1294	FA060R.....	1134
EO220R.....	1225	ER243R.....	1289	ER876.....	1295	FA061R.....	1134
EO221R.....	1225	ER244R.....	1289			FA062R.....	1134
EO222R.....	1225	ER245R.....	1289	ET096R.....	1295	FA063R.....	1134
EO225R.....	1225	ER246R.....	1289	ET140R.....	1211	FA064R.....	1134
EO240R.....	1226	ER247R.....	1289	ET141R.....	1211	FA065R.....	1134
EO242R.....	1226	ER248R.....	1289	ET150R.....	1211	FA066R.....	1134
EO310R.....	1228	ER320R.....	1289	ET152R.....	1210	FA067R.....	1135
EO315R.....	1228	ER321R.....	1289	ET205R.....	1234	FA068R.....	1135
EO332R.....	1229	ER322R.....	1289	ET210R.....	1234	FA069R.....	1136
EO338R.....	1229	ER323R.....	1289	ET220R.....	1234	FA070R.....	1136
EO405R.....	1231	ER324R.....	1289	ET221R.....	1234	FA071R.....	1136
EO407R.....	1230	ER325R.....	1289	ET237R.....	1235	FA072R.....	1136
EO415R.....	1230	ER326R.....	1289	ET245R.....	1236	FA073R.....	1136
EO420R.....	1231	ER327R.....	1289	ET255R.....	1236	FA074R.....	1136
EO422R.....	1232	ER328R.....	1289	ET269R.....	1239	FA075R.....	1136
EO433R.....	1233	ER329R.....	1289	ET270R.....	1239	FA076R.....	1137
EO435R.....	1233	ER330R.....	1289	ET301R.....	1241		
		ER401R.....	1290	ET302R.....	1241	FB031R.....	491
ER005R.....	1288	ER402R.....	1290	ET306R.....	1242	FB033.....	491
ER011R.....	1288	ER403R.....	1290	ET307R.....	1242	FB034R.....	491
ER012R.....	1288	ER404R.....	1290	ET308R.....	1242	FB035R.....	491
ER015R.....	1288	ER405R.....	1290	ET315R.....	1243	FB036R.....	491
ER025R.....	1293	ER406R.....	1290	ET316R.....	1243	FB037R.....	491
ER050R.....	1246	ER411R.....	1290	ET325R.....	1244	FB038R.....	491
ER061R.....	1247	ER412R.....	1290	ET326R.....	1244	FB040R.....	491
ER062R.....	1247	ER413R.....	1290	ET327R.....	1244	FB053R.....	491
ER063R.....	1247	ER414R.....	1290	ET329R.....	1245	FB054R.....	491
ER064R.....	1247	ER415R.....	1290			FB055R.....	491
ER066R.....	1248	ER416R.....	1290	FA005R.....	721	FB108R.....	493
ER068R.....	1248	ER421R.....	1290	FA006R.....	721	FB109R.....	493
ER070R.....	1250	ER422R.....	1290	FA007R.....	721	FB110R.....	493
ER080R.....	1249	ER423R.....	1290	FA025R.....	720	FB112R.....	493
ER211R.....	1292	ER424R.....	1290	FA026R.....	720	FB113R.....	493
ER212R.....	1292	ER425R.....	1290	FA030R.....	1131	FB114R.....	493
ER213R.....	1292	ER426R.....	1290	FA031R.....	1131	FB115R.....	493
ER214R.....	1292	ER520R.....	1291	FA032R.....	1132	FB116R.....	493
ER215R.....	1292	ER521R.....	1291	FA033R.....	1132	FB117R.....	493
ER216R.....	1292	ER522R.....	1291	FA034R.....	1132	FB119R.....	493
ER219R.....	1289	ER523R.....	1291	FA035R.....	1132	FB120R.....	492
ER220R.....	1289	ER524R.....	1291	FA036R.....	1132	FB121R.....	492
ER221R.....	1289	ER525R.....	1291	FA037R.....	1132	FB122R.....	492

CATALOG NUMBER	PAGE	CATALOG NUMBER	PAGE	CATALOG NUMBER	PAGE	CATALOG NUMBER	PAGE
FB124R.....	492	FB388T.....	379	FB449R.....	405	FB506R.....	454
FB125R.....	492	FB389T.....	379	FB450R.....	426	FB507R.....	454
FB126R.....	492	FB390T.....	379	FB451R.....	426	FB508R.....	454
FB130R.....	101	FB391T.....	379	FB452R.....	428	FB510R.....	418
FB141R.....	1019	FB392T.....	379	FB453R.....	427	FB511R.....	418
FB142R.....	1019	FB394R.....	98	FB454R.....	428	FB512R.....	418
FB143R.....	1019	FB395R.....	98	FB455R.....	427	FB513R.....	418
FB150R.....	494	FB396R.....	98	FB456R.....	428	FB515R.....	419
FB151R.....	494	FB397R.....	372	FB457R.....	427	FB516R.....	419
FB153R.....	497	FB398R.....	372	FB458R.....	429	FB517R.....	419
FB154R.....	497	FB399R.....	372	FB459R.....	429	FB518R.....	419
FB155R.....	497	FB400R.....	99	FB460R.....	429	FB519R.....	452
FB156R.....	497	FB401R.....	100	FB461R.....	429	FB520R.....	452
FB160R.....	494	FB402R.....	99	FB462R.....	429	FB521R.....	406
FB161R.....	494	FB403R.....	100	FB463R.....	435	FB522R.....	406
FB162R.....	494	FB404R.....	99	FB464R.....	435	FB523R.....	406
FB163R.....	494	FB405R.....	99	FB465R.....	436	FB524R.....	406
FB164R.....	494	FB406R.....	99	FB466R.....	437	FB525R.....	414
FB165R.....	494	FB407R.....	99	FB467R.....	413	FB526R.....	407
FB166R.....	494	FB408R.....	99	FB468R.....	413	FB527R.....	407
FB167R.....	494	FB409R.....	99	FB469R.....	413	FB532R.....	407
FB168R.....	494	FB410R.....	100	FB470R.....	438	FB533R.....	407
FB169R.....	494	FB411R.....	98	FB471R.....	440	FB534R.....	407
FB170R.....	494	FB412R.....	98	FB472R.....	440	FB535R.....	407
FB172R.....	494	FB414R.....	99	FB473R.....	440	FB540R.....	408
FB194B.....	1103	FB415R.....	99	FB475R.....	442	FB541R.....	408
FB194R.....	504	FB416R.....	99	FB476R.....	441	FB542R.....	408
FB195R.....	504	FB417R.....	99	FB477R.....	441	FB543R.....	408
FB196R.....	504	FB418R.....	98	FB478R.....	441	FB544R.....	408
FB201R.....	504	FB419R.....	98	FB480R.....	440	FB546R.....	432
FB202R.....	504	FB420R.....	485	FB481R.....	444	FB547R.....	432
FB203R.....	504	FB421R.....	485	FB482R.....	443	FB548R.....	432
FB204R.....	504	FB422R.....	485	FB483R.....	414	FB549R.....	432
FB328R.....	485	FB423R.....	485	FB484R.....	415	FB550R.....	429
FB329R.....	485	FB424R.....	485	FB485R.....	415	FB552R.....	428
FB330R.....	485	FB425R.....	485	FB486R.....	416	FB553R.....	427
FB331R.....	485	FB426R.....	485	FB487R.....	416	FB557R.....	409
FB352R.....	486	FB427R.....	485	FB488R.....	445	FB558R.....	409
FB353R.....	486	FB431R.....	487	FB489R.....	446	FB559R.....	412
FB357R.....	486	FB432R.....	487	FB490R.....	447	FB560R.....	412
FB358R.....	486	FB433R.....	487	FB491R.....	448	FB561R.....	412
FB359R.....	486	FB434R.....	487	FB492R.....	447	FB563R.....	409
FB370R.....	488	FB435R.....	487	FB493R.....	449	FB567R.....	410
FB374R.....	488	FB436R.....	487	FB494R.....	450	FB568R.....	410
FB375R.....	488	FB437R.....	487	FB495R.....	451	FB569R.....	410
FB376R.....	488	FB440R.....	404	FB498R.....	415	FB570R.....	410
FB377R.....	488	FB441R.....	404	FB499R.....	415	FB573R.....	417
FB382R.....	483	FB442R.....	404	FB500R.....	453	FB574R.....	417
FB383R.....	483	FB443R.....	404	FB501R.....	453	FB576R.....	455
FB384R.....	484	FB446R.....	405	FB502R.....	453	FB578R.....	456
FB385R.....	484	FB447R.....	405	FB503R.....	453	FB581R.....	411
FB387T.....	379	FB448R.....	405	FB504R.....	453	FB582R.....	411

Numerical Index

FB - FD

CATALOG NUMBER	PAGE	CATALOG NUMBER	PAGE	CATALOG NUMBER	PAGE	CATALOG NUMBER	PAGE
FB590R.....	411	FB730R.....	468	FB882R.....	503	FC333T.....	387
FB591R.....	411	FB731R.....	459	FB890R.....	503	FC334T.....	388
FB592R.....	411	FB732R.....	459	FB918R.....	503	FC335T.....	388
FB593R.....	411	FB734R.....	463	FB923R.....	509	FC336T.....	388
FB600R.....	400	FB735R.....	463	FB924R.....	509	FC337T.....	389
FB602R.....	401	FB736R.....	464	FB925R.....	509	FC338T.....	389
FB604R.....	401	FB737R.....	464	FB926R.....	509	FC339T.....	389
FB605R.....	401	FB738R.....	469	FB927R.....	509	FC340T.....	389
FB617R.....	415	FB741R.....	410	FB930R.....	394	FC341T.....	389
FB618R.....	420	FB743R.....	461	FB934R.....	112	FC342T.....	389
FB619R.....	420	FB754R.....	465	FB936R.....	113	FC343T.....	389
FB633R.....	402	FB755R.....	465	FB938R.....	107	FC411R.....	98
FB634R.....	402	FB756R.....	465	FB950R.....	400	FC412R.....	98
FB635R.....	402	FB764R.....	472	FB954R.....	397	FC413R.....	98
FB640R.....	466	FB765R.....	473	FB955R.....	397	FC418R.....	98
FB641R.....	466	FB775R.....	474	FB961R.....	403		
FB642R.....	466	FB776R.....	476	FB963R.....	510	FD011R.....	821
FB644R.....	466	FB777R.....	476	FB964R.....	510	FD012R.....	822
FB647R.....	466	FB778R.....	476	FB965R.....	510	FD013R.....	822
FB649R.....	466	FB779R.....	476	FB966R.....	510	FD014R.....	821
FB669R.....	423	FB780R.....	476	FB967R.....	510	FD015R.....	821
FB670R.....	423	FB784R.....	100	FB968R.....	510	FD016R.....	822
FB672R.....	424	FB785R.....	100			FD017R.....	822
FB673R.....	424	FB786R.....	100	FC004R.....	505	FD018R.....	821
FB674R.....	425	FB800R.....	524	FC005R.....	505	FD019R.....	821
FB675R.....	425	FB802R.....	520	FC014R.....	505	FD020R.....	353, 828
FB700R.....	458	FB803R.....	521	FC015R.....	505	FD021R.....	353, 828
FB701R.....	458	FB804R.....	521	FC030.....	505	FD022R.....	353, 768
FB702R.....	458	FB805R.....	522	FC034R.....	505	FD023R.....	353, 768
FB703R.....	458	FB806R.....	522	FC035R.....	505	FD028R.....	353
FB704R.....	458	FB807R.....	522	FC040A.....	518	FD030R.....	1074
FB705R.....	458	FB830R.....	520	FC041A.....	518	FD031R.....	1074
FB706R.....	458	FB835R.....	523	FC042A.....	519	FD032R.....	1074
FB707R.....	458	FB836R.....	520	FC043A.....	519	FD033R.....	1074
FB708R.....	458	FB841R.....	525	FC044A.....	519	FD034R.....	1074
FB710R.....	464	FB842R.....	525	FC310R.....	477	FD035R.....	1074
FB711R.....	465	FB844R.....	525	FC311R.....	477	FD036R.....	1074
FB712R.....	464	FB845R.....	526	FC312R.....	477	FD037R.....	1075
FB713R.....	464	FB846R.....	526	FC313R.....	477	FD038R.....	1075
FB714R.....	465	FB850R.....	529	FC320T.....	381	FD039R.....	1075
FB715R.....	464	FB851R.....	528	FC321T.....	381	FD040R.....	1075
FB717R.....	468	FB852R.....	533	FC322T.....	382	FD043R.....	1075
FB718R.....	468	FB853R.....	533	FC323T.....	382	FD044R.....	1075
FB719R.....	468	FB854R.....	533	FC324T.....	382	FD045R.....	357
FB721R.....	467	FB855R.....	533	FC325T.....	382	FD046R.....	357
FB722R.....	467	FB856R.....	533	FC326T.....	383	FD048R.....	357
FB723R.....	467	FB857R.....	533	FC327T.....	384	FD056R.....	356, 1077
FB724R.....	467	FB858R.....	533	FC328T.....	384	FD057R.....	356, 1077
FB725R.....	461	FB870R.....	502	FC329T.....	386	FD059R.....	356, 1077
FB726R.....	461	FB873R.....	502	FC330T.....	385	FD060R.....	1075
FB727R.....	461	FB878R.....	502	FC331T.....	385	FD061R.....	1075
FB729R.....	467	FB881R.....	503	FC332T.....	387	FD062R.....	1076

CATALOG NUMBER	PAGE	CATALOG NUMBER	PAGE	CATALOG NUMBER	PAGE	CATALOG NUMBER	PAGE
FD075R.....	1074	FD253R.....	375	FD398R.....	1121	FD718B.....	1084
FD076R.....	357	FD258R.....	363	FD399R.....	1121	FD719B.....	1084
FD079R.....	357	FD259R.....	363	FD410R.....	1124	FD731B.....	1083
FD080R.....	357	FD262R.....	1123	FD411R.....	1124	FD732B.....	1083
FD081R.....	357	FD270R.....	1123	FD412R.....	1124	FD733B.....	1083
FD092R.....	1082	FD271R.....	1123	FD413R.....	1124	FD734B.....	1083
FD093R.....	1082	FD272R.....	1123	FD414R.....	1124	FD735B.....	1083
FD096R.....	1082	FD273R.....	1123	FD415R.....	1124	FD736B.....	1083
FD097R.....	1082	FD280R.....	836	FD416R.....	1124	FD741B.....	1084
FD100R.....	356, 822	FD281R.....	836	FD418R.....	1124	FD743B.....	1084
FD101R.....	356, 822	FD284R.....	775	FD460R.....	1103	FD761B.....	1084
FD103R.....	356, 822	FD285R.....	775	FD467R.....	1087	FD763B.....	1084
FD105R.....	356, 1076	FD286R.....	775	FD481B.....	1101	FD766B.....	1084
FD106R.....	356, 1076	FD287R.....	775	FD482B.....	1101	FD767B.....	1084
FD107R.....	356, 1076	FD298R.....	1125	FD483B.....	1101	FD768B.....	1084
FD108R.....	356, 1076	FD301R.....	1119	FD484B.....	1101	FD769B.....	1084
FD110R.....	88	FD302R.....	1119	FD485B.....	1101	FD771B.....	1083
FD111R.....	88	FD303R.....	1119	FD488B.....	1102	FD772B.....	1083
FD113D.....	1126	FD304R.....	1119	FD489B.....	1102	FD773B.....	1083
FD114D.....	1126	FD305R.....	1119	FD490B.....	1102	FD774B.....	1083
FD115D.....	1126	FD311R.....	507	FD493B.....	1103	FD775B.....	1083
FD116D.....	1126	FD312R.....	507	FD494B.....	1103	FD776B.....	1083
FD120R.....	358, 1082	FD320R.....	1119	FD495B.....	1103	FD786B.....	1084
FD200R.....	1081	FD321R.....	1119	FD560R.....	809	FD787B.....	1084
FD202R.....	1081	FD322R.....	1119	FD561R.....	809	FD788B.....	1084
FD204R.....	1081	FD330R.....	1113	FD562R.....	809	FD789B.....	1084
FD210R.....	1080	FD331R.....	1113	FD568R.....	809	FD797B.....	1086
FD212R.....	1080	FD332R.....	1113	FD569R.....	809	FD798B.....	1086
FD214R.....	1080	FD333R.....	1112	FD571R.....	809	FD799B.....	1086
FD215R.....	1081	FD334R.....	1113	FD572R.....	809	FD805B.....	1086
FD216R.....	1080	FD335R.....	1113	FD575R.....	810	FD808B.....	1086
FD217R.....	1081	FD336R.....	1113	FD576R.....	810	FD809B.....	1086
FD222R.....	1142	FD337R.....	1113	FD611R.....	810	FD811B.....	1085
FD223R.....	1080	FD338R.....	1112	FD612R.....	810	FD812B.....	1085
FD224R.....	1143	FD343R.....	1112	FD613R.....	810	FD814B.....	1086
FD226R.....	1142	FD344R.....	1112	FD614R.....	810	FD815B.....	1086
FD228R.....	1142	FD346R.....	1112	FD615R.....	810	FD816B.....	1086
FD229R.....	1080	FD347R.....	1125	FD622R.....	488	FD818B.....	1085
FD230R.....	358, 829	FD350R.....	1125	FD623R.....	488	FD819B.....	1085
FD231R.....	358, 829	FD351R.....	1125	FD624R.....	488	FD821B.....	1086
FD232R.....	358, 829	FD352R.....	1125	FD628R.....	488	FD822B.....	1086
FD233R.....	358, 829	FD353R.....	1125	FD635R.....	810	FD823B.....	1086
FD240R.....	358	FD354R.....	1125	FD636R.....	810	FD824B.....	1087
FD241R.....	358	FD365R.....	1125	FD701B.....	1083	FD825B.....	1087
FD242R.....	359, 831	FD366R.....	1125	FD702B.....	1083	FD826B.....	1087
FD243R.....	359, 831	FD375R.....	1120	FD703B.....	1083	FD827B.....	1087
FD244R.....	359	FD376R.....	1120	FD704B.....	1083	FD828B.....	1087
FD245R.....	359	FD392R.....	1120	FD705B.....	1083	FD831B.....	1087
FD246R.....	359	FD394R.....	1122	FD706B.....	1083	FD832B.....	1087
FD247R.....	359	FD395R.....	1122	FD711B.....	1084	FD833B.....	1087
FD251R.....	767	FD396R.....	1121	FD713B.....	1084	FD835B.....	1087
FD252R.....	767	FD397R.....	1121	FD717B.....	1084	FD836B.....	1087

Numerical Index

FD - FF

CATALOG NUMBER	PAGE	CATALOG NUMBER	PAGE	CATALOG NUMBER	PAGE	CATALOG NUMBER	PAGE
FD839B.....	1087	FE005K.....	489	FF088R.....	1053	FF280R.....	1157
FD840B.....	1087	FE010K.....	489	FF115R.....	1055	FF282R.....	1157
FD841B.....	1087	FE011K.....	489	FF116R.....	1055	FF283R.....	1157
FD848B.....	1085	FE012K.....	489	FF117R.....	1055	FF284R.....	1158
FD849B.....	1085	FE013K.....	489	FF118R.....	1055	FF285R.....	1157
FD861R.....	1125	FE014K.....	489	FF119R.....	1055	FF286R.....	1157
FD864R.....	1125	FE020K.....	489	FF125R.....	1152	FF291R.....	1114
FD866R.....	1125	FE021K.....	489	FF126R.....	1152	FF292R.....	1114
FD868R.....	1125	FE022K.....	489	FF130R.....	1073	FF293R.....	1114
FD870R.....	808	FE023K.....	489	FF136R.....	1053	FF294R.....	1114
FD871R.....	808	FE024K.....	489	FF137R.....	1053	FF295R.....	1115
FD872R.....	808	FE030S.....	490	FF138R.....	1053	FF300R.....	1117
FD873R.....	808	FE031S.....	490	FF148R.....	1161	FF301R.....	1117
FD874R.....	808	FE032S.....	490	FF149R.....	1161	FF302R.....	1117
FD875R.....	808	FE034S.....	490	FF150R.....	1162	FF303R.....	1115
FD876R.....	808	FE040S.....	490	FF151R.....	1162	FF305R.....	1115
FD877R.....	808	FE041S.....	490	FF152R.....	1162	FF307R.....	1115
FD878R.....	808	FE042S.....	490	FF153R.....	1162	FF309.....	1123
FD879R.....	808	FE044S.....	490	FF154R.....	1162	FF310R.....	1115
FD880R.....	808			FF155R.....	1070	FF311R.....	1116
FD881R.....	808	FF003R.....	1069	FF156R.....	1070	FF312R.....	1116
FD882R.....	808	FF005R.....	1069	FF163R.....	1160	FF313R.....	1118
FD883R.....	808	FF007P.....	1068	FF165R.....	1160	FF321R.....	1118
FD884R.....	808	FF010R.....	1070	FF180R.....	1159	FF322R.....	1118
FD885R.....	808	FF011R.....	1070	FF185R.....	1160	FF326R.....	1114
FD886R.....	808	FF012R.....	1068	FF187R.....	1160	FF327R.....	1114
FD887R.....	808	FF013P.....	1068	FF190R.....	1161	FF345R.....	1143
FD888R.....	808	FF014R.....	1069	FF191R.....	1161	FF349R.....	1116
FD889R.....	808	FF015P.....	1069	FF193R.....	1161	FF431R.....	1162
FD890R.....	808	FF020R.....	1070	FF201R.....	1164	FF441R.....	1164
FD891R.....	808	FF022R.....	1070	FF202R.....	1164	FF442R.....	1164
FD892R.....	808	FF025R.....	1055	FF211R.....	1164	FF443R.....	1164
FD893R.....	808	FF026R.....	1055	FF212R.....	1164	FF444R.....	1164
FD894R.....	808	FF027R.....	1055	FF213R.....	1164	FF445R.....	1164
FD895R.....	808	FF028R.....	1055	FF214R.....	1164	FF446R.....	1164
FD896R.....	808	FF029R.....	1055	FF216R.....	1164	FF466R.....	1057
FD897R.....	808	FF056R.....	1071	FF217R.....	1164	FF467R.....	1057
FD901R.....	1104	FF057R.....	1071	FF222R.....	1164	FF468R.....	1057
FD902R.....	1104	FF061R.....	1071	FF231R.....	1163	FF469R.....	1057
FD903R.....	1104	FF062R.....	1071	FF232R.....	1163	FF480R.....	1163
FD904R.....	1104	FF063R.....	1071	FF233R.....	1163	FF482R.....	1163
FD905R.....	1105	FF064R.....	1071	FF256R.....	1163	FF484R.....	1163
FD906R.....	1105	FF065R.....	1071	FF257R.....	1163	FF486R.....	1163
FD907R.....	1105	FF066R.....	1071	FF258R.....	1163	FF488R.....	1163
FD908R.....	1104	FF067R.....	1071	FF259R.....	1163	FF496R.....	1057
FD909R.....	1104	FF068R.....	1071	FF260R.....	1159	FF497R.....	1057
FD910R.....	1104	FF077R.....	1055	FF262R.....	1159	FF498R.....	1057
FD911R.....	1104	FF078R.....	1055	FF266R.....	1159	FF499R.....	1057
FD912R.....	1104	FF079R.....	1055	FF268R.....	1159	FF502R.....	1037
FD913R.....	1104	FF080R.....	1055	FF270R.....	1158	FF503R.....	1037
		FF086R.....	1053	FF273R.....	1158	FF504R.....	1037
		FF087R.....	1053	FF274R.....	1158	FF513R.....	1037

CATALOG NUMBER	PAGE	CATALOG NUMBER	PAGE	CATALOG NUMBER	PAGE	CATALOG NUMBER	PAGE
FF514R.....	1037	FF635R.....	1141	FF699R.....	1156	FF781R.....	1054
FF523R.....	1038	FF637R.....	1141	FF700R.....	1155	FF782R.....	1054
FF524R.....	1038	FF638R.....	1051	FF701R.....	1155	FF783R.....	1054
FF532R.....	1037	FF639R.....	1051	FF702R.....	1155	FF784R.....	1054
FF533R.....	1037	FF640R.....	1140	FF703R.....	1155	FF785R.....	1054
FF534R.....	1037	FF641R.....	1140	FF707R.....	1154	FF799R.....	631
FF535R.....	1037	FF642R.....	1140	FF708R.....	1154	FF800R.....	631
FF536R.....	1037	FF643R.....	1140	FF709R.....	1154	FF801R.....	632
FF543R.....	1037	FF644R.....	1141	FF710R.....	1156	FF803R.....	1040
FF544R.....	1037	FF645R.....	1052	FF711R.....	1054	FF805R.....	1041
FF545R.....	1037	FF646R.....	1052	FF712R.....	1054	FF806R.....	1041
FF553R.....	1038	FF649R.....	1051	FF713R.....	1054	FF807R.....	1042
FF554R.....	1038	FF650R.....	1130	FF714R.....	1054	FF808R.....	1039
FF562R.....	1037	FF651R.....	1130	FF715R.....	1051	FF809R.....	1056
FF563R.....	1037	FF652R.....	1130	FF716R.....	1055	FF810R.....	1041
FF564R.....	1037	FF653R.....	1130	FF717R.....	1051	FF811R.....	1042
FF565R.....	1037	FF657R.....	1051	FF718R.....	1055	FF812R.....	1056
FF566R.....	1037	FF658R.....	1052	FF719R.....	1056	FF813R.....	1056
FF573R.....	1037	FF659R.....	1052	FF720R.....	1051	FF814R.....	1042
FF574R.....	1037	FF660R.....	1053	FF721R.....	1056	FF815R.....	1056
FF575R.....	1037	FF661R.....	1052	FF722R.....	1051	FF816R.....	1056
FF583R.....	1038	FF662R.....	1052	FF723R.....	1056	FF817R.....	1056
FF584R.....	1038	FF663R.....	1052	FF724R.....	1051	FF818R.....	1044
FF589R.....	673, 1128	FF664R.....	1052	FF725R.....	1054	FF819R.....	1056
FF590B.....	1128	FF665R.....	1052	FF726R.....	1051	FF821R.....	1056
FF590R.....	673, 1128	FF666R.....	1052	FF727R.....	1051	FF828R.....	1056
FF591R.....	673, 1128	FF667R.....	1052	FF728R.....	1051	FF829R.....	1056
FF595R.....	673, 1128	FF668R.....	1052	FF729R.....	1051	FF830R.....	1056
FF599R.....	1039	FF669R.....	1052	FF734R.....	1052	FF831R.....	1056
FF600R.....	1039	FF673R.....	1052	FF737R.....	1051	FF832R.....	1045
FF605R.....	1038	FF674R.....	1051	FF738R.....	1051	FF833R.....	1045
FF608R.....	1131	FF677R.....	1053	FF739R.....	1053	FF834R.....	1045
FF609R.....	1131	FF678R.....	1053	FF741R.....	1056	FF835R.....	1045
FF610R.....	679	FF679R.....	1053	FF742R.....	1056	FF841R.....	1056
FF611R.....	1129	FF680R.....	1053	FF743R.....	1056	FF842R.....	1045
FF614R.....	1129	FF682R.....	1051	FF745R.....	1053	FF843R.....	1045
FF616R.....	1129	FF683R.....	1051	FF746R.....	1052	FF844R.....	1045
FF617R.....	1129	FF684R.....	1051	FF747R.....	1052	FF852R.....	1045
FF618R.....	1129	FF685R.....	1051	FF748R.....	1052	FF853R.....	1045
FF619R.....	1130	FF686R.....	1051	FF749R.....	1052	FF854R.....	1045
FF620R.....	1130	FF687R.....	1051	FF750R.....	1055	FF856R.....	1046
FF621R.....	1130	FF688R.....	1051	FF751R.....	1053	FF857R.....	1046
FF622R.....	1130	FF689R.....	1051	FF752R.....	1055		
FF623R.....	1130	FF690R.....	1051	FF753R.....	1053	FG052R.....	1033
FF624R.....	1131	FF691R.....	1051	FF754R.....	1055	FG055R.....	1050
FF625R.....	1139	FF692R.....	1054	FF755R.....	1055	FG057R.....	1046
FF626R.....	1139	FF693R.....	1054	FF765R.....	1039	FG093R.....	993
FF627R.....	1138	FF694R.....	1054	FF769R.....	1052	FG094R.....	993
FF628R.....	1138	FF695R.....	1054	FF770R.....	1052	FG095R.....	993
FF629R.....	1139	FF696R.....	1051	FF771R.....	1052	FG096R.....	993
FF631R.....	1129	FF697R.....	1156	FF772R.....	1052		
FF632R.....	1129	FF698R.....	1156	FF773R.....	1052		

Numerical Index

FH - FK

CATALOG NUMBER	PAGE	CATALOG NUMBER	PAGE	CATALOG NUMBER	PAGE	CATALOG NUMBER	PAGE
FH100R.....	308	FH872B.....	1036	FH984B.....	1036	FK306R.....	960
FH101R.....	308	FH873B.....	1036	FH985B.....	1036	FK307R.....	960
FH102R.....	308	FH874B.....	1036			FK308R.....	960
FH103R.....	308	FH875B.....	1036	FK110R.....	926	FK309R.....	960
FH116R.....	308	FH881B.....	1036	FK111R.....	926	FK310R.....	660
FH300R.....	309	FH882B.....	1036	FK113R.....	926	FK317R.....	804
FH301C.....	309	FH883B.....	1036	FK114R.....	926	FK318R.....	804
FH302C.....	309	FH884B.....	1036	FK116R.....	927	FK319R.....	804
FH320R.....	309	FH885B.....	1036	FK117R.....	927	FK321R.....	804
FH325R.....	309	FH891B.....	1035	FK118R.....	927	FK323R.....	962
FH326R.....	309	FH892B.....	1035	FK119R.....	927	FK324R.....	962
FH335R.....	310	FH893B.....	1035	FK120R.....	969	FK325R.....	962
FH403.....	1072	FH894B.....	1035	FK121R.....	969	FK328R.....	1153
FH404.....	1072	FH895B.....	1035	FK124R.....	969	FK329R.....	1153
FH405.....	1072	FH901B.....	1035	FK130R.....	970	FK340R.....	498
FH407.....	1072	FH902B.....	1035	FK131R.....	970	FK341R.....	498
FH414.....	310, 1072	FH903B.....	1035	FK133R.....	970	FK344R.....	498
FH415.....	310, 1072	FH904B.....	1035	FK135R.....	970	FK345R.....	498
FH430R.....	310, 1072	FH905B.....	1035	FK136R.....	970	FK348R.....	966
FH480R.....	310, 1073	FH911B.....	1035	FK139R.....	970	FK350R.....	963
FH801B.....	1035	FH912B.....	1035	FK140R.....	971	FK351R.....	963
FH802B.....	1035	FH913B.....	1035	FK146R.....	965	FK352R.....	967
FH803B.....	1035	FH914B.....	1035	FK147R.....	965	FK353R.....	967
FH804B.....	1035	FH915B.....	1035	FK148R.....	965	FK355R.....	499
FH805B.....	1035	FH921B.....	1035	FK158R.....	972	FK356R.....	499
FH811B.....	1035	FH922B.....	1035	FK160R.....	931	FK357R.....	499
FH812B.....	1035	FH923B.....	1035	FK161R.....	932	FK358R.....	499
FH813B.....	1035	FH924B.....	1035	FK162R.....	932	FK359R.....	499
FH814B.....	1035	FH925B.....	1035	FK166R.....	928	FK360R.....	963
FH815B.....	1035	FH931B.....	1035	FK167R.....	933	FK381R.....	500
FH821B.....	1035	FH932B.....	1035	FK168R.....	937	FK382R.....	500
FH822B.....	1035	FH933B.....	1035	FK169R.....	933	FK383R.....	500
FH823B.....	1035	FH934B.....	1035	FK170R.....	928	FK384R.....	500
FH824B.....	1035	FH935B.....	1035	FK171R.....	929	FK387R.....	500
FH825B.....	1035	FH951B.....	1036	FK172R.....	930	FK400R.....	501
FH837B.....	1035	FH952B.....	1036	FK173R.....	930	FK401R.....	501
FH838B.....	1035	FH953B.....	1036	FK174R.....	938	FK402R.....	501
FH839B.....	1035	FH954B.....	1036	FK175R.....	938	FK403R.....	501
FH847B.....	1036	FH955B.....	1036	FK176R.....	929	FK408R.....	501
FH848B.....	1036	FH961B.....	1036	FK177R.....	937	FK409R.....	501
FH849B.....	1036	FH962B.....	1036	FK180R.....	939	FK410R.....	964
FH851B.....	1036	FH963B.....	1036	FK185R.....	934	FK411R.....	964
FH852B.....	1036	FH964B.....	1036	FK186R.....	934	FK412R.....	964
FH853B.....	1036	FH965B.....	1036	FK187R.....	934	FK413R.....	964
FH854B.....	1036	FH971B.....	1036	FK188R.....	935	FK414R.....	964
FH855B.....	1036	FH972B.....	1036	FK189R.....	936	FK420R.....	502
FH861B.....	1036	FH973B.....	1036	FK193R.....	939	FK505R.....	959
FH862B.....	1036	FH974B.....	1036	FK292R.....	1019	FK507R.....	957
FH863B.....	1036	FH975B.....	1036	FK293R.....	1019	FK510R.....	957
FH864B.....	1036	FH981B.....	1036	FK300R.....	960	FK511R.....	957
FH865B.....	1036	FH982B.....	1036	FK301R.....	959	FK530R.....	805
FH871B.....	1036	FH983B.....	1036	FK302R.....	959	FK532R.....	805

CATALOG NUMBER	PAGE	CATALOG NUMBER	PAGE	CATALOG NUMBER	PAGE	CATALOG NUMBER	PAGE
FK534R	805	FK662R	1000	FK881R	1059	FK917B	1051
FK541R	805	FK663R	1000	FK882R	1058	FK917R	1051
FK543R	805	FK664R	1000	FK883R	1058	FK918B	1051
FK552R	805	FK665R	1000	FK884R	1058	FK918R	1051
FK581R	1007	FK666R	1004	FK885R	1058	FK919B	1051
FK582R	1007	FK668R	1004	FK886R	1058	FK919R	1051
FK583R	1007	FK670R	1004	FK887R	1058	FK920B	1051
FK584R	1007	FK672R	1004	FK888SU	1059	FK920R	1051
FK585R	1007	FK675R	1000	FK891R	1059	FK921B	1051
FK586R	1007	FK676R	1000	FK892R	1058	FK921R	1051
FK587R	1007	FK677R	1000	FK893R	1058	FK922B	1051
FK588R	1007	FK678R	1000	FK894R	1058	FK922R	1051
FK589R	1007	FK679R	1000	FK895R	1058	FK923B	1052
FK591R	1007	FK688R	1003	FK896R	1058	FK923R	1052
FK592R	1007	FK689R	1003	FK898214	1058	FK924B	1052
FK593R	1007	FK690R	1003	FK898215	1058	FK924R	1052
FK594R	1007	FK702R	1001	FK898R	1058	FK925B	1052
FK595R	1007	FK703R	1001	FK899R	1058	FK925R	1052
FK596R	1007	FK704R	1001	FK900B	1051	FK926B	1052
FK597R	1007	FK705R	1001	FK900R	1051	FK926R	1052
FK598R	1007	FK712R	1001	FK901B	1051	FK927B	1052
FK599R	1007	FK713R	1001	FK901R	1051	FK927R	1052
FK611R	999	FK714R	1001	FK902B	1051	FK928B	1052
FK612R	999	FK715R	1001	FK902R	1051	FK928R	1052
FK613R	999	FK723R	1001	FK903B	1051	FK929B	1052
FK614R	999	FK724R	1001	FK903R	1051	FK929R	1052
FK615R	999	FK725R	1001	FK904B	1051	FK930R	1054
FK616R	999	FK773R	1004	FK904R	1051	FK931R	1054
FK617R	999	FK774R	1004	FK905B	1051	FK932R	1054
FK621R	999	FK775R	1004	FK905R	1051	FK933R	1054
FK622R	999	FK783R	1004	FK906B	1052	FK934R	1054
FK623R	999	FK784R	1004	FK906R	1052	FK936R	1054
FK624R	999	FK785R	1004	FK907B	1052	FK937R	1054
FK625R	999	FK800R	588	FK907R	1052	FK938R	1054
FK626R	999	FK801R	588	FK908B	1052	FK939R	1054
FK627R	999	FK803R	697	FK908R	1052	FK940R	1054
FK630R	999	FK813R	697	FK909B	1052	FK943R	1054
FK631R	999	FK814R	697	FK909R	1052	FK944R	1054
FK632R	999	FK817R	696	FK910B	1052	FK945R	1054
FK633R	999	FK834R	1005	FK910R	1052	FK946R	1054
FK634R	999	FK835R	1005	FK911B	1051	FK948B	1055
FK635R	999	FK836R	1005	FK911R	1051	FK948R	1055
FK636R	999	FK840R	697	FK912B	1051	FK949B	1055
FK637R	999	FK842R	697	FK912R	1051	FK949R	1055
FK638R	999	FK845R	998	FK913B	1051	FK950B	1055
FK639R	999	FK846R	998	FK913R	1051	FK950R	1055
FK651R	695	FK848R	998	FK914B	1051	FK951B	1055
FK652R	695	FK850R	998	FK914R	1051	FK951R	1055
FK653R	695	FK854R	1006	FK915B	1051	FK952B	1055
FK654R	695	FK855R	1006	FK915R	1051	FK952R	1055
FK658R	998	FK863R	1006	FK916B	1051	FK953B	1055
FK659R	998	FK864R	1006	FK916R	1051	FK953R	1055

Numerical Index

FK - FL

CATALOG NUMBER	PAGE	CATALOG NUMBER	PAGE	CATALOG NUMBER	PAGE	CATALOG NUMBER	PAGE
FK954R	1056	FK984B	1053	FL132R	800	FL406R	980
FK955R	1056	FK984R	1053	FL134R	800	FL407R	980
FK956R	1056	FK985B	1053	FL136R	800	FL408R	980
FK957R	1056	FK985R	1053	FL144R	801	FL411R	977
FK958R	1056	FK986B	1051	FL146R	801	FL412R	977
FK960B	1051	FK986R	1051	FL148R	801	FL413R	977
FK961B	1052	FK987B	1051	FL153R	800	FL415R	977
FK961R	1052	FK987R	1051	FL156R	982	FL416R	977
FK962B	1052	FK988B	1051	FL157R	982	FL417R	977
FK962R	1052	FK988R	1051	FL158R	982	FL418R	977
FK963B	1052	FK989B	1051	FL159R	982	FL420R	977
FK963R	1052	FK989R	1051	FL160R	982	FL423R	977
FK964B	1052			FL166R	982	FL430R	976
FK964R	1052	FL010	988	FL167R	982	FL437R	976
FK965B	1052	FL011	988	FL168R	982	FL438R	976
FK965R	1052	FL034	988	FL169R	982	FL439R	976
FK966B	1051	FL035R	988	FL170R	982	FL440R	976
FK966R	1051	FL036R	694, 988	FL173R	799	FL441R	978
FK967B	1051	FL037	694, 988	FL174R	799	FL443R	978
FK967R	1051	FL038R	693, 990	FL175R	799	FL445R	978
FK968B	1052	FL044R	990	FL176R	799	FL503R	974
FK968R	1052	FL055R	990	FL183R	799	FL504R	974
FK969B	1052	FL059R	991	FL184R	799	FL505R	974
FK969R	1052	FL060R	991	FL185R	799	FL506R	974
FK970B	1053	FL062	992	FL186R	799	FL507R	974
FK970R	1053	FL064R	992	FL187R	799	FL512R	982
FK971B	1053	FL065	992	FL213R	800	FL513R	982
FK971R	1053	FL066R	992	FL214R	800	FL514R	982
FK972B	1053	FL068R	992	FL215R	800	FL515R	982
FK972R	1053	FL088R	986	FL216R	800	FL516R	982
FK973B	1053	FL090R	993	FL223R	800	FL517R	982
FK973R	1053	FL093R	694	FL224R	800	FL523R	982
FK974B	1053	FL094R	694	FL225R	800	FL524R	982
FK974R	1053	FL095R	694	FL226R	800	FL525R	982
FK975B	1053	FL096R	694	FL227R	800	FL526R	982
FK975R	1053	FL101R	986	FL343R	800	FL527R	982
FK976B	1052	FL102R	986	FL345R	800	FL553R	982
FK976R	1052	FL104R	986	FL347R	800	FL554R	982
FK977B	1052	FL106R	986	FL380R	980	FL555R	982
FK977R	1052	FL108R	986	FL381R	980	FL556R	982
FK978B	1052	FL109R	986	FL382R	980	FL557R	982
FK978R	1052	FL110R	801	FL383R	980	FL573R	978
FK979B	1052	FL112R	801	FL384R	980	FL574R	978
FK979R	1052	FL114R	801	FL390R	976	FL575R	978
FK980B	1052	FL116R	801	FL391R	976	FL576R	978
FK980R	1052	FL118R	801	FL392R	976	FL577R	978
FK981B	1051	FL120R	799	FL393R	976	FL650R	987
FK981R	1051	FL122R	799	FL394R	976	FL651R	987
FK982B	1053	FL124R	799	FL401R	980	FL652R	987
FK982R	1053	FL126R	799	FL402R	980	FL653R	987
FK983B	1053	FL128R	799	FL403R	980	FL654R	987
FK983R	1053	FL130R	800	FL405R	980	FL655R	987

CATALOG NUMBER	PAGE	CATALOG NUMBER	PAGE	CATALOG NUMBER	PAGE	CATALOG NUMBER	PAGE
FL656R.....	987	FM125R.....	1091	FM252T.....	366	FM485R.....	355
FL658R.....	987	FM130R.....	1089	FM253T.....	366	FM486R.....	355
FL659R.....	987	FM131R.....	1090	FM254T.....	366	FM488R.....	355
FL660R.....	987	FM132R.....	1089	FM258T.....	366	FM489R.....	355
FL661R.....	987	FM133R.....	1090	FM259T.....	366	FM490R.....	355
FL662R.....	987	FM134R.....	1089	FM260T.....	366	FM491R.....	355
FL665R.....	974	FM135R.....	1091	FM276R.....	365	FM492R.....	355
FL666R.....	975	FM140R.....	1089	FM317T.....	378	FM493R.....	355
FL668R.....	975	FM141R.....	1090	FM318T.....	378	FM503R.....	355
FL670R.....	975	FM142R.....	1089	FM319T.....	378	FM504R.....	355
FL672R.....	975	FM143R.....	1090	FM327T.....	378	FM505R.....	355
FL682R.....	975	FM144R.....	1089	FM328T.....	378	FM506R.....	355
FL685R.....	975	FM145R.....	1091	FM329T.....	378	FM507R.....	355
FL687R.....	975	FM146B.....	1088	FM337T.....	378	FM508R.....	355
FL701R.....	978	FM147B.....	1088	FM338T.....	378	FM520R.....	364
FL702R.....	978	FM148B.....	1088	FM339T.....	378	FM521R.....	364
FL711R.....	1118	FM149B.....	1088	FM388R.....	361	FM522R.....	364
FL781R.....	987	FM150R.....	1093	FM390R.....	361	FM523R.....	364
FL783R.....	987	FM151R.....	1093	FM392R.....	359	FM524R.....	364
FL785R.....	987	FM153R.....	1093	FM430R.....	354	FM525R.....	364
FL788R.....	987	FM154R.....	1093	FM431R.....	354	FM526R.....	364
FL789R.....	987	FM156R.....	1093	FM432R.....	354	FM527R.....	364
FL790R.....	987	FM157R.....	1093	FM433R.....	354	FM528R.....	364
		FM159R.....	1090	FM434R.....	354	FM529R.....	364
FM001R.....	776	FM160R.....	1090	FM435R.....	354	FM530R.....	364
FM002R.....	776	FM161R.....	1091	FM436R.....	354	FM531R.....	364
FM003R.....	776	FM162R.....	1091	FM437R.....	354	FM532R.....	364
FM004R.....	776	FM163R.....	1091	FM438R.....	354	FM533R.....	364
FM005R.....	776	FM164R.....	1091	FM439R.....	354	FM534R.....	365
FM006R.....	776	FM167R.....	1092	FM440R.....	354	FM535R.....	365
FM010R.....	767	FM168R.....	1092	FM441R.....	354	FM536R.....	365
FM011R.....	767	FM169R.....	1092	FM442R.....	354	FM537R.....	365
FM012R.....	767	FM170R.....	1095	FM444R.....	354	FM538R.....	365
FM013R.....	767	FM173R.....	1095	FM451R.....	354	FM539R.....	365
FM014R.....	767	FM174R.....	1094	FM452R.....	354	FM540R.....	362
FM021R.....	359	FM175R.....	1095	FM453R.....	354	FM541R.....	362
FM033R.....	373	FM176R.....	1094	FM454R.....	354	FM542R.....	362
FM034R.....	373	FM177R.....	1094	FM455R.....	354	FM543R.....	362
FM035R.....	374	FM178R.....	1094	FM470R.....	354	FM544R.....	362
FM036R.....	374	FM179R.....	1094	FM471R.....	354	FM545R.....	362
FM040R.....	767	FM218R.....	363	FM472R.....	354	FM546R.....	362
FM041R.....	767	FM221R.....	363	FM473R.....	354	FM547R.....	362
FM042R.....	768	FM223R.....	363	FM474R.....	354	FM548R.....	362
FM043R.....	768	FM228R.....	363	FM476R.....	355	FM549R.....	362
FM053R.....	376	FM230R.....	363	FM477R.....	355	FM550R.....	362
FM054R.....	376	FM232T.....	366	FM478R.....	355	FM551R.....	362
FM063R.....	374	FM233T.....	366	FM479R.....	355	FM552R.....	362
FM120R.....	1089	FM234T.....	366	FM480R.....	355	FM553R.....	363
FM121R.....	1090	FM236R.....	364	FM481R.....	355	FM554R.....	363
FM122R.....	1089	FM238T.....	366	FM482R.....	355	FM555R.....	363
FM123R.....	1090	FM239T.....	366	FM483R.....	355	FM560R.....	365
FM124R.....	1089	FM240T.....	366	FM484R.....	355	FM561R.....	365

Numerical Index

FM - FO

CATALOG NUMBER	PAGE	CATALOG NUMBER	PAGE	CATALOG NUMBER	PAGE	CATALOG NUMBER	PAGE
FM563R.....	364	FM695R.....	1096	FO160R.....	912	F0521R.....	1030
FM564R.....	364	FM696R.....	1096	FO161R.....	912	F0522R.....	1031
FM565R.....	364	FM697R.....	1096	FO162R.....	912	F0523R.....	1031
FM566R.....	364	FM700R.....	1097	FO169R.....	913	F0525R.....	1032
FM567R.....	364	FM701R.....	1097	FO170R.....	913	F0526R.....	1031
FM568R.....	364	FM702R.....	1097	FO171R.....	913	F0527R.....	1031
FM570R.....	377	FM705R.....	1097	FO172R.....	913	F0530R.....	1032
FM571R.....	377	FM706R.....	1097	FO173R.....	913	F0532R.....	1032
FM572R.....	377	FM707R.....	1097	FO180R.....	914	F0534R.....	1033
FM573R.....	377	FM710R.....	1098	FO181R.....	914	F0550R.....	1034
FM574R.....	377	FM711R.....	1098	FO182R.....	914	F0551R.....	1034
FM575R.....	377	FM712R.....	1098	FO183R.....	914	F0555R.....	1034
FM576R.....	377	FM715R.....	1098	FO190R.....	915	F0570R.....	1033
FM577R.....	377	FM716R.....	1098	FO191R.....	915	F0572R.....	1033
FM578R.....	377	FM717R.....	1098	FO192R.....	915	F0599R.....	1020
FM579R.....	377	FM720R.....	1099	FO193R.....	915	F0601R.....	1060
FM580R.....	377	FM721R.....	1099	FO199R.....	916	F0602R.....	1060
FM581R.....	377	FM722R.....	1099	FO399R.....	1020	F0604R.....	639, 1060
FM582R.....	376	FM725R.....	1099	FO400R.....	1020	F0610R.....	1062
FM583R.....	377	FM726R.....	1099	FO406R.....	700, 1021	F0611R.....	1062
FM584R.....	376	FM727R.....	1099	FO407R.....	700, 1021	F0612R.....	1060
FM585R.....	377	FM730R.....	1096-1099	FO409R.....	702, 1021	F0614R.....	1062
FM586R.....	376	FM731R.....	1096-1099	FO410R.....	700, 1021	F0620R.....	1061
FM587R.....	376	FM732R.....	1096-1099	FO411R.....	702, 1022	F0622R.....	1061
FM588R.....	376			FO412R.....	702, 1022	F0624R.....	1061
FM590R.....	374	F0106R.....	903	FO415R.....	700, 1023	F0626R.....	1061
FM591R.....	374	F0108R.....	903	FO416R.....	1023	F0632R.....	1061
FM592R.....	374	F0110R.....	904	FO428R.....	1022	F0634R.....	1061
FM593R.....	377	F0111R.....	904	FO430R.....	701, 1023	F0636R.....	1061
FM594R.....	377	F0112R.....	904	FO432R.....	701, 1023	F0640R.....	1062
FM595R.....	377	F0113R.....	905	FO440R.....	699, 1024	F0641R.....	1062
FM596R.....	377	F0115R.....	905	FO442R.....	701, 1023	F0645R.....	1061
FM597R.....	376	F0116R.....	905	FO450R.....	702, 1024	F0646R.....	1061
FM598R.....	376	F0117R.....	906	FO451R.....	702, 1024	F0647R.....	1061
FM599R.....	377	F0118R.....	906	FO453R.....	699, 1025	F0648R.....	1063
FM600R.....	374	F0120R.....	906	FO455R.....	703, 1025	F0649R.....	1063
FM665R.....	1100	F0123R.....	907	FO457R.....	699, 1025	F0800R.....	900
FM670R.....	1096	F0124R.....	907	FO460R.....	1022	F0801R.....	900
FM671R.....	1096	F0125R.....	907	FO461R.....	1022	F0807R.....	901
FM672R.....	1096	F0127R.....	908	FO462R.....	1022	F0808R.....	901
FM675R.....	1096	F0130R.....	908	FO463R.....	1022	F0810R.....	902
FM676R.....	1096	F0135R.....	908	FO467R.....	1026	F0816R.....	902
FM677R.....	1096	F0136R.....	908	FO470R.....	1026	F0820R.....	1046
FM680R.....	1097	F0140R.....	909	FO472R.....	1026	F0855R.....	899
FM681R.....	1097	F0141R.....	909	FO475R.....	1027	F0856R.....	899
FM682R.....	1097	F0143R.....	909	FO500R.....	700, 1028	F0857R.....	899
FM685R.....	1097	F0148R.....	910	FO502R.....	700, 1028	F0900R.....	802
FM686R.....	1097	F0150R.....	910	FO511R.....	1028	F0901R.....	802
FM687R.....	1097	F0151R.....	911	FO514R.....	699, 1028	F0903R.....	802
FM690R.....	1096	F0153R.....	912	FO515R.....	703, 1029	F0917A.....	794
FM691R.....	1096	F0158R.....	910	FO518R.....	1029	F0918A.....	794
FM692R.....	1096	F0159R.....	911	FO520R.....	1030	F0935R.....	780

CATALOG NUMBER	PAGE	CATALOG NUMBER	PAGE	CATALOG NUMBER	PAGE	CATALOG NUMBER	PAGE
FO939R.....	780	GF253R.....	1146	GF395R.....	321, 1144	GF775R.....	579
FO940R.....	777	GF254R.....	1146	GF396R.....	321, 1144	GF821R.....	312
FO950R.....	780	GF255R.....	1146	GF397R.....	321, 1144	GF822R.....	313
FO951R.....	780	GF256R.....	1146	GF398R.....	321, 1144	GF823R.....	313
		GF257R.....	1146	GF399R.....	321, 1144	GF824R.....	313
FR110R.....	996	GF258R.....	1146	GF401R.....	321, 1144	GF825R.....	313
FR118R.....	996	GF260R.....	1146	GF402R.....	321, 1144	GF860R.....	311
FR120R.....	996	GF261R.....	1146	GF403R.....	321, 1144	GF862R.....	311
FR125R.....	997	GF262R.....	1146	GF404R.....	321, 1144	GF911R.....	578
FR140R.....	997	GF263R.....	1146	GF405R.....	321, 1144	GF912R.....	578
FR141R.....	997	GF264R.....	1146	GF406R.....	321, 1144	GF913R.....	578
		GF265R.....	1146	GF407R.....	321, 1144	GF917R.....	312, 1152
GA468R.....	1059	GF266R.....	1146	GF408R.....	321, 1144	GF919R.....	312, 689
		GF267R.....	1146	GF409R.....	321, 1144	GF923R.....	320, 691
GB020R.....	974	GF268R.....	1146	GF411R.....	321, 1144	GF925R.....	320, 691
		GF270R.....	1146	GF412R.....	321, 1144	GF933R.....	317
GF005B.....	1145	GF271R.....	1146	GF413R.....	321, 1144	GF944200.....	316
GF025B.....	1145	GF272R.....	1146	GF414R.....	321, 1144	GF944R.....	316
GF026B.....	1145	GF273R.....	1146	GF415R.....	321, 1144	GF946R.....	314
GF027B.....	1145	GF274R.....	1146	GF416R.....	321, 1144	GF947R.....	314
GF030B.....	1145	GF275R.....	1146	GF417R.....	321, 1144	GF948R.....	314
GF031B.....	1145	GF276R.....	1146	GF418R.....	321, 1144	GF980R.....	322
GF032B.....	1145	GF277R.....	1146	GF419R.....	321, 1144		
GF033B.....	1145	GF278R.....	1146	GF421R.....	321, 1144	GK033R.....	79
GF035B.....	1145	GF350R.....	318, 1151	GF422R.....	321, 1144	GK195.....	1198
GF036B.....	1145	GF351R.....	318, 1151	GF423R.....	321, 1144	GK560R.....	1190
GF037B.....	1145	GF352R.....	318, 1151	GF424R.....	321, 1144	GK561R.....	1190
GF038B.....	1145	GF353R.....	318, 1151	GF425R.....	321, 1144	GK580R.....	1190
GF039B.....	1145	GF354R.....	318, 1151	GF426R.....	321, 1144	GK581R.....	1190
GF045B.....	1145	GF355R.....	318, 1151	GF427R.....	321, 1144	GK595R.....	1187
GF046B.....	1145	GF360R.....	318, 1151	GF428R.....	321, 1144	GK596R.....	1187
GF047B.....	1145	GF361R.....	318, 1151	GF429R.....	321, 1144	GK597R.....	1187
GF048B.....	1145	GF362R.....	318, 1151	GF431R.....	1147	GK604R.....	1182
GF049B.....	1145	GF363R.....	318, 1151	GF432R.....	1147	GK605R.....	1182
GF055B.....	1145	GF364R.....	318, 1151	GF470R.....	1147	GK606R.....	1182
GF056B.....	1145	GF365R.....	318, 1151	GF471R.....	1147	GK614R.....	1182
GF057B.....	1145	GF370R.....	318, 1151	GF472R.....	1147	GK615R.....	1182
GF058B.....	1145	GF371R.....	318, 1151	GF473R.....	1147	GK616R.....	1182
GF059B.....	1145	GF372R.....	318, 1151	GF474R.....	1147	GK624R.....	1182
GF235R.....	1146	GF373R.....	318, 1151	GF475R.....	1147	GK625R.....	1182
GF240R.....	1146	GF374R.....	318, 1151	GF476R.....	1147	GK644R.....	1182
GF241R.....	1146	GF375R.....	318, 1151	GF477R.....	1147	GK645R.....	1182
GF242R.....	1146	GF380R.....	318, 1151	GF478R.....	1147	GK646R.....	1182
GF243R.....	1146	GF381R.....	318, 1151	GF479R.....	1147	GK660R.....	1173
GF244R.....	1146	GF382R.....	318, 1151	GF480R.....	1147	GK670R.....	1173
GF245R.....	1146	GF383R.....	318, 1151	GF481R.....	1147	GK671R.....	1173
GF246R.....	1146	GF384R.....	318, 1151	GF768R.....	579	GK675R.....	1173
GF247R.....	1146	GF385R.....	318, 1151	GF770R.....	579	GK677R.....	1173
GF248R.....	1146	GF391R.....	321, 1144	GF771R.....	579	GK679R.....	1173
GF250R.....	1146	GF392R.....	321, 1144	GF772R.....	579	GK685R.....	1179
GF251R.....	1146	GF393R.....	321, 1144	GF773R.....	579	GK690R.....	1185
GF252R.....	1146	GF394R.....	321, 1144	GF774R.....	579	GK700R.....	1184

Numerical Index

GK - MA

CATALOG NUMBER	PAGE	CATALOG NUMBER	PAGE	CATALOG NUMBER	PAGE	CATALOG NUMBER	PAGE
GK701R.....	1184	GK842R.....	1194	LX171R.....	895	MA037R.....	698
GK703R.....	1184	GK843R.....	1194	LX172R.....	895	MA038R.....	698
GK711R.....	1184	GK844R.....	1194	LX174R.....	896	MA039R.....	698
GK713R.....	1184	GK845R.....	1194	LX175S.....	897	MA044R.....	698
GK719R.....	1188	GK846R.....	1194	LX176R.....	892	MA045R.....	877
GK720R.....	1185	GK847R.....	1194	LX177R.....	897	MA046R.....	877
GK722R.....	1185	GK848R.....	1194	LX178R.....	897	MA047R.....	877
GK723R.....	1185	GK899R.....	1180	LX179R.....	892	MA049R.....	877
GK730R.....	1185	GK900R.....	1180	LX181R.....	897	MA050R.....	877
GK746R.....	1169	GK910R.....	1180	LX182R.....	897	MA051R.....	589
GK747R.....	1169	GK920R.....	1180	LX183R.....	897	MA053R.....	586
GK748R.....	1169	GK929R.....	1180	LX185R.....	897	MA054R.....	586
GK749R.....	1169	GK930R.....	1180	LX189R.....	898	MA055R.....	586
GK760R.....	1169	GK940R.....	1180	LX190R.....	898	MA056R.....	574
GK761R.....	1169	GK950R.....	1180	LX548R.....	883	MA057R.....	574
GK762R.....	1169	GK959R.....	1180	LX550R.....	884	MA058R.....	698
GK763R.....	1169	GK960R.....	1180	LX552R.....	884	MA059R.....	698
GK764R.....	1169	GK970R.....	1180	LX553R.....	884	MA060R.....	698
GK765R.....	1169	GK972R.....	1181	LX556R.....	883	MA061R.....	698
GK766R.....	1169	GK974R.....	1181	LX558R.....	883	MA062R.....	698
GK767R.....	1169	GK976R.....	1181	LX565R.....	885	MA066R.....	742
GK768R.....	1170	GK978R.....	1181	LX600R.....	886	MA067R.....	742
GK769R.....	1170	GK980R.....	1180	LX605R.....	886	MA069R.....	559
GK770R.....	1170			LX618R.....	886	MA070R.....	618
GK771R.....	1170	GL470R.....	1188	LX624R.....	886	MA071R.....	563
GK772R.....	1170	GL471R.....	1188			MA072R.....	563
GK773R.....	1170	GL480R.....	1188	MA001R.....	876	MA073R.....	563
GK774R.....	1170	GL481R.....	1188	MA002R.....	876	MA074R.....	563
GK775R.....	1170			MA004R.....	1064	MA075R.....	563
GK777R.....	1172	GN085.....	1198	MA005R.....	876	MA076R.....	562
GK780R.....	1172	GN145.....	1198	MA006R.....	584	MA077R.....	562
GK781R.....	1172	GN146.....	1198	MA007R.....	584	MA078R.....	562
GK785R.....	1172	GN219.....	1198	MA008R.....	584	MA079R.....	562
GK788R.....	1171	GN224.....	1198	MA009R.....	584	MA080R.....	562
GK789R.....	1171			MA010R.....	689	MA081R.....	564
GK790R.....	1171	HF021R.....	887	MA011R.....	691	MA082R.....	564
GK791R.....	1171	HF213R.....	886	MA012R.....	691	MA083R.....	564
GK793R.....	1171			MA013R.....	678	MA084R.....	564
GK822R.....	1189	JG504R.....	325	MA014R.....	678	MA085R.....	564
GK823R.....	1189	JG506R.....	325	MA016R.....	678	MA086R.....	564
GK824R.....	1189			MA017R.....	678	MA087R.....	564
GK825R.....	1189	LX150R.....	888	MA018R.....	678	MA088R.....	564
GK826R.....	1189	LX152R.....	888	MA019R.....	580	MA089R.....	563
GK827R.....	1189	LX156R.....	888	MA020R.....	580	MA090R.....	563
GK828R.....	1189	LX157R.....	889	MA021R.....	580	MA091R.....	563
GK829R.....	1189	LX158R.....	889	MA025R.....	580	MA092R.....	563
GK831R.....	1172	LX159R.....	890	MA026R.....	580	MA093R.....	563
GK832R.....	1172	LX162R.....	890	MA028R.....	551	MA094R.....	563
GK833R.....	1172	LX163R.....	890	MA031R.....	585	MA095R.....	563
GK838R.....	1194	LX164R.....	894	MA032R.....	585	MA096R.....	563
GK840R.....	1194	LX165R.....	894	MA035R.....	588	MA097R.....	563
GK841R.....	1194	LX170R.....	895	MA036R.....	588	MA098R.....	563

CATALOG NUMBER	PAGE	CATALOG NUMBER	PAGE	CATALOG NUMBER	PAGE	CATALOG NUMBER	PAGE
MA099R	563	MA154R	835	MA212R	688	MA276R	575
MA100R	563	MA155R	839	MA213R	571	MA278R	571
MA101R	563	MA156R	90	MA214R	570	MA279R	586
MA102R	563	MA157R	839	MA215R	570	MA281R	584
MA103R	563	MA158R	835	MA216R	570	MA282R	537
MA104R	563	MA159R	543	MA217R	570	MA283R	537
MA105R	564	MA160R	837	MA218R	570	MA284R	559
MA106R	564	MA161R	837	MA219R	570	MA285R	584
MA107R	564	MA163R	544	MA221R	570	MA286R	584
MA108R	564	MA164R	544	MA222R	571	MA289R	725
MA109R	564	MA165R	544	MA223R	572	MA290R	659
MA110R	564	MA166R	839	MA224R	572	MA291R	741
MA111R	564	MA167R	839	MA225R	572	MA292R	573
MA112R	564	MA168R	545	MA226R	572	MA298R	552
MA114R	565	MA169R	545	MA227R	571	MA299R	729
MA115R	565	MA170R	840	MA228R	571	MA300R	735
MA116R	565	MA171R	840	MA230R	569	MA301R	735
MA117R	565	MA172R	161, 713	MA232R	575	MA302R	731
MA118R	565	MA173R	542	MA233R	575	MA303R	731
MA119R	565	MA174R	542	MA234R	575	MA304R	731
MA120R	565	MA175R	581	MA235R	575	MA305R	731
MA121R	565	MA176R	581	MA236R	575	MA306R	731
MA124R	566	MA177R	581	MA238R	585	MA307R	731
MA125R	566	MA178R	651	MA239R	693	MA308R	731
MA126R	566	MA179R	651	MA240R	546	MA309R	731
MA127R	566	MA180R	554	MA241R	546	MA310R	731
MA128R	566	MA181R	554	MA242R	546	MA311R	735
MA129R	567	MA182R	554	MA243R	548	MA312R	735
MA130R	566	MA183R	554	MA244R	548	MA313R	735
MA131R	566	MA184R	554	MA245R	548	MA314R	735
MA132R	566	MA185R	190, 785	MA246R	548	MA315R	732
MA133R	566	MA186R	651	MA247R	548	MA316R	840
MA134R	566	MA188R	589	MA248R	546	MA317R	840
MA135R	566	MA189R	554	MA249R	546	MA318R	598
MA136R	566	MA190R	554	MA251R	560	MA319R	732
MA137R	567	MA194R	861	MA252R	586	MA320R	641
MA138R	582	MA195R	832	MA253R	587	MA321R	641
MA139R	660	MA196R	832	MA254R	587	MA322R	641
MA140R	582	MA197R	832	MA255R	582	MA323R	641
MA141R	661	MA198R	832	MA256R	582	MA324R	641
MA142R	692, 798	MA199R	832	MA257R	583	MA325R	624
MA143R	664	MA200R	832	MA258R	583	MA326R	624
MA144R	663	MA201R	832	MA259R	584	MA327R	624
MA145R	659	MA202R	305	MA260R	584	MA328R	624
MA146R	659	MA203R	301	MA261R	561	MA329R	621
MA147R	658	MA204R	569	MA263R	561	MA330R	621
MA148R	835	MA205R	687	MA264R	561	MA331R	618
MA149R	835	MA207R	687	MA265R	570	MA332R	684
MA150R	835	MA208R	571	MA267R	558	MA333R	684
MA151R	835	MA209R	569	MA270R	583	MA334R	684
MA152R	835	MA210R	569	MA272R	559	MA335R	598
MA153R	835	MA211R	688	MA273R	559	MA336R	598

Numerical Index

MA

CATALOG NUMBER	PAGE	CATALOG NUMBER	PAGE	CATALOG NUMBER	PAGE	CATALOG NUMBER	PAGE
MA337R.....	598	MA399R.....	561	MA460R.....	708	MA524R.....	578
MA338R.....	694	MA401R.....	554	MA461R.....	816	MA525R.....	578
MA340R.....	631	MA402R.....	561	MA462R.....	816	MA526R.....	578
MA341R.....	631	MA403R.....	561	MA463R.....	600	MA528R.....	578
MA342R.....	631	MA404R.....	561	MA464R.....	18	MA529R.....	578
MA343R.....	631	MA405R.....	560	MA465R.....	18	MA530R.....	578
MA344R.....	640	MA406R.....	560	MA466R.....	609, 751, 815	MA531R.....	578
MA345R.....	640	MA407R.....	865	MA467R.....	609, 751, 815	MA532R.....	578
MA346R.....	667	MA408R.....	686	MA468R.....	610, 750, 814	MA533R.....	743
MA348R.....	670	MA409.....	865	MA469R.....	610, 750, 814	MA534R.....	743
MA349R.....	670	MA410R.....	865	MA470R.....	610, 750, 814	MA535R.....	743
MA350R.....	670	MA411R.....	865	MA471R.....	812	MA536R.....	90
MA351R.....	829	MA412R.....	865	MA472R.....	812	MA537R.....	91, 618
MA352R.....	358, 829	MA413R.....	865	MA473R.....	812	MA538R.....	838
MA353R.....	830	MA414R.....	865	MA474R.....	812	MA539R.....	717
MA354R.....	830	MA415R.....	628	MA475R.....	817	MA540R.....	717
MA355R.....	830	MA416R.....	675	MA476R.....	817	MA541R.....	632
MA356R.....	830	MA417R.....	675	MA477R.....	817	MA542R.....	632
MA357R.....	358, 829	MA418R.....	675, 958	MA478R.....	817	MA543R.....	632
MA358R.....	829	MA419R.....	677, 959	MA479R.....	818	MA544R.....	632
MA360R.....	829	MA420R.....	677, 959	MA480R.....	818	MA545R.....	637
MA362R.....	617	MA421R.....	674	MA483R.....	822	MA546R.....	637
MA363R.....	830	MA422R.....	652	MA484R.....	822	MA548R.....	840
MA364R.....	830	MA423R.....	652	MA485R.....	822	MA549R.....	541
MA365R.....	830	MA424R.....	652	MA486R.....	822	MA550R.....	539
MA366R.....	830	MA425R.....	653	MA487R.....	828	MA551R.....	615
MA367R.....	830	MA426R.....	653	MA489R.....	568	MA552R.....	615
MA368R.....	830	MA427R.....	653	MA490R.....	727, 728	MA553R.....	615
MA369R.....	680	MA428R.....	653	MA493R.....	727	MA554R.....	615
MA374R.....	537	MA430R.....	654	MA494R.....	576	MA555R.....	623
MA375R.....	537	MA431R.....	655	MA495R.....	577	MA556R.....	623
MA376R.....	538	MA432R.....	557	MA496R.....	577	MA557R.....	623
MA377R.....	538	MA433R.....	557	MA497R.....	577	MA558R.....	638
MA378R.....	538	MA434R.....	724, 848	MA498R.....	577	MA559R.....	628
MA379R.....	550	MA435R.....	724, 848	MA499300.....	318, 690, 798	MA560R.....	644
MA380R.....	550	MA436R.....	724, 848	MA499R.....	318, 690, 798	MA561R.....	646
MA381R.....	680	MA437R.....	724, 848	MA500R.....	690	MA562R.....	646
MA382R.....	680	MA438R.....	275, 656	MA501300.....	318, 690, 798	MA563R.....	636
MA384R.....	685	MA439R.....	590	MA501R.....	318, 690, 798	MA564R.....	636
MA385.....	865	MA440R.....	590	MA502R.....	577	MA565R.....	636
MA386R.....	558	MA441R.....	590	MA503R.....	577	MA566R.....	640
MA388R.....	558	MA442R.....	590	MA504R.....	689	MA567R.....	643
MA389R.....	558	MA444R.....	536	MA505R.....	689	MA568R.....	637
MA390R.....	558	MA445R.....	707	MA506R.....	689	MA569R.....	637
MA391R.....	559	MA449R.....	596	MA508R.....	689	MA570R.....	635
MA392R.....	559	MA450R.....	597	MA513R.....	579	MA571R.....	635
MA393R.....	559	MA451R.....	600	MA514R.....	579	MA572R.....	635
MA394R.....	560	MA452R.....	601	MA515R.....	579	MA573R.....	636
MA395R.....	560	MA453R.....	602	MA516R.....	579	MA574R.....	636
MA396R.....	560	MA455R.....	603	MA518R.....	579	MA575R.....	626
MA397R.....	560	MA456R.....	552	MA522R.....	579	MA576R.....	626
MA398R.....	561	MA458R.....	606, 758	MA523R.....	578	MA577R.....	626

CATALOG NUMBER	PAGE	CATALOG NUMBER	PAGE	CATALOG NUMBER	PAGE	CATALOG NUMBER	PAGE
MA578R	626	MA631R	858	MA701R	634	MA777R	851
MA579R	626	MA632R	860	MA703R	539	MA778R	851
MA580R	626	MA633R	860	MA704R	550	MA779R	851
MA581R	626	MA634R	860	MA706R	674	MA780R	851
MA582R	626	MA635R	861	MA709R	604	MA781R	851
MA583R	626	MA636R	861	MA713R	602	MA782R	852
MA584R	627	MA637R	855	MA714R	727	MA783R	852
MA585R	628	MA638R	847	MA715R	692	MA784R	852
MA586R	574	MA640R	875	MA716R	692	MA785R	852
MA587R	574	MA641R	875	MA717R	576	MA786R	852
MA588R	695	MA642R	686	MA718R	576	MA789R	853
MA589R	695	MA643R	661	MA719R	723	MA790R	853
MA590R	695	MA644R	573	MA726R	843	MA791R	853
MA591R	695	MA645R	712	MA731R	850	MA792R	853
MA592R	695	MA646R	564	MA732R	862	MA793R	853
MA593R	695	MA647R	564	MA733R	862	MA794R	854
MA594R	691	MA648R	563	MA734R	862	MA795R	854
MA595R	691	MA649R	563	MA735R	862	MA796R	854
MA596R	691	MA650R	567	MA736R	862	MA797R	854
MA597R	616	MA651R	567	MA737R	862	MA798R	855
MA598R	616	MA652R	567	MA738R	862	MA799R	855
MA599R	598	MA653R	587	MA739R	862	MA800R	861
MA600R	598	MA654R	741	MA740R	862	MA801R	855
MA601R	615	MA655R	741	MA741R	862	MA803R	856
MA602R	592	MA656R	741	MA742R	862	MA804R	856
MA603R	592	MA657R	583	MA743R	862	MA805R	856
MA604R	592	MA658R	583	MA744R	850	MA806R	856
MA605R	593	MA659R	543	MA745R	850	MA807R	856
MA606R	567	MA660R	551	MA747R	850	MA808R	856
MA607R	692	MA662R	551	MA749R	849	MA809R	857
MA608R	723	MA663R	711	MA750R	846	MA810R	857
MA609R	599	MA669R	638	MA751R	845	MA811R	857
MA610R	816	MA670R	638	MA752R	845	MA812R	857
MA611R	600	MA671R	622	MA754R	845	MA813R	858
MA612R	827	MA672R	625	MA755R	845	MA814R	858
MA613R	828	MA673R	625	MA756R	845	MA815R	858
MA614R	828	MA674R	625	MA757R	846	MA816R	858
MA615R	619	MA675R	625	MA758R	846	MA817R	859
MA617R	841	MA676R	633	MA759R	846	MA818R	859
MA618R	836	MA678R	633	MA760R	846	MA819T	857
MA619R	841	MA680R	633	MA761R	850	MA820R	859
MA620R	841	MA684R	642	MA762R	846	MA821R	859
MA621R	841	MA686R	642	MA763R	846	MA822T	854
MA622R	842	MA688R	647	MA764R	846	MA823R	855
MA623R	843	MA689R	647	MA765	849	MA824R	856
MA624R	842	MA690R	647	MA766R	850	MA825T	857
MA625R	842	MA694R	642	MA767R	877	MA826T	858
MA626R	843	MA695R	642	MA771R	877	MA827T	858
MA627R	617	MA697R	634	MA773R	877	MA828R	860
MA628R	830	MA698R	634	MA774R	818	MA829R	862
MA629R	581	MA699R	634	MA775R	859	MA833R	863
MA630R	856	MA700R	634	MA776R	854	MA834R	863

Numerical Index

MA - MB

CATALOG NUMBER	PAGE	CATALOG NUMBER	PAGE	CATALOG NUMBER	PAGE	CATALOG NUMBER	PAGE
MA835R.....	863	MA893R.....	833	MA956R.....	874	MB095R.....	399
MA836R.....	863	MA896R.....	838	MA957R.....	870	MB096R.....	399
MA837R.....	863	MA897T.....	841	MA958R.....	874	MB097R.....	399
MA838R.....	864	MA898T.....	838	MA959R.....	869	MB098R.....	144
MA839R.....	864	MA899R.....	843	MA960R.....	874	MB099R.....	144
MA840R.....	864	MA900R.....	843	MA962R.....	872	MB103R.....	714
MA841R.....	864	MA901R.....	839	MA963R.....	872	MB104R.....	300
MA842R.....	864	MA902R.....	840	MA964R.....	872	MB106R.....	884
MA843R.....	864	MA907R.....	831	MA965R.....	875	MB107R.....	653
MA844R.....	864	MA908R.....	831	MA968R.....	875	MB108R.....	581, 679
MA845R.....	864	MA909R.....	831	MA970R.....	869	MB109R.....	606, 758
MA846R.....	864	MA910R.....	831	MA971R.....	865	MB110R.....	677
MA847R.....	825	MA911R.....	831	MA974R.....	877	MB116R.....	709
MA848R.....	824	MA915R.....	867	MA975R.....	862	MB117R.....	589
MA849R.....	824	MA916R.....	867	MA976R.....	818	MB118R.....	687
MA850R.....	823	MA917R.....	866			MB119R.....	687
MA851R.....	823	MA918R.....	866	MB039R.....	586	MB120R.....	129
MA852R.....	824	MA919R.....	866	MB044R.....	558	MB126R.....	129
MA853R.....	824	MA920R.....	866	MB047R.....	508	MB127R.....	303
MA854R.....	824	MA921R.....	866	MB048R.....	508	MB128R.....	154
MA855R.....	824	MA922R.....	868	MB049R.....	536	MB129R.....	240
MA856R.....	825	MA923R.....	868	MB051200.....	316	MB130R.....	137, 1258
MA857R.....	825	MA924R.....	865	MB051R.....	316	MB136R.....	111
MA858R.....	824	MA925R.....	869	MB052R.....	317	MB137R.....	111
MA859R.....	825	MA926R.....	869	MB053R.....	317	MB138R.....	141
MA860R.....	825	MA927R.....	869	MB054R.....	657	MB139R.....	141
MA861R.....	826	MA930R.....	869	MB055R.....	558	MB140R.....	601
MA862R.....	826	MA931R.....	869	MB056R.....	394	MB141R.....	300
MA864R.....	826	MA932R.....	870	MB057R.....	394	MB146R.....	9, 881
MA865R.....	821	MA933R.....	870	MB058R.....	173	MB147R.....	604
MA866R.....	826	MA934R.....	870	MB059R.....	180	MB148R.....	12
MA867R.....	826	MA935.....	870	MB060R.....	203	MB149R.....	15
MA868R.....	827	MA936.....	870	MB061R.....	173	MB150R.....	604, 758
MA870R.....	827	MA937R.....	870	MB062R.....	371	MB156R.....	956
MA871R.....	818	MA938R.....	870	MB063R.....	494	MB157R.....	956
MA873R.....	825	MA939R.....	871	MB064R.....	340	MB158R.....	1322
MA874R.....	817	MA940R.....	871	MB065R.....	340	MB159R.....	1322
MA875R.....	836	MA941R.....	871	MB066R.....	1265	MB160R.....	1322
MA876R.....	837	MA942R.....	872	MB067R.....	1266	MB161R.....	1322
MA877R.....	844	MA943R.....	872	MB068R.....	1262	MB162R.....	1322
MA878R.....	839	MA944R.....	872	MB069R.....	1237	MB163R.....	1322
MA879R.....	842	MA945R.....	872	MB070R.....	399	MB164R.....	1322
MA880R.....	842	MA946R.....	872	MB084R.....	984	MB165R.....	1322
MA881R.....	840	MA947R.....	872	MB085R.....	984	MB166R.....	1322
MA882R.....	844	MA948R.....	872	MB087R.....	984	MB167R.....	1322
MA883R.....	844	MA949R.....	873	MB088R.....	984	MB168R.....	1322
MA884R.....	844	MA950R.....	873	MB089R.....	984	MB169R.....	1322
MA885R.....	837	MA951R.....	873	MB090R.....	984	MB170R.....	1322
MA886R.....	837	MA952R.....	873	MB091R.....	399	MB171R.....	29
MA888R.....	876	MA953R.....	873	MB092R.....	399	MB172R.....	156, 396
MA891R.....	838	MA954R.....	873	MB093R.....	399	MB173R.....	1322
MA892R.....	838	MA955R.....	874	MB094R.....	399	MB174R.....	605

CATALOG NUMBER	PAGE	CATALOG NUMBER	PAGE	CATALOG NUMBER	PAGE	CATALOG NUMBER	PAGE
MB175R	605	MB239R	481	MB297R	662	MB383R	511
MB176R	572	MB240	422	MB298R	1237	MB384R	788
MB177R	956	MB241	422	MB299R	1237	MB385R	511
MB178R	956	MB242R	565	MB300R	112	MB386R	511
MB179R	288	MB243R	565	MB303R	693	MB387R	511
MB180R	152	MB244R	565	MB308R	104	MB388R	685, 985
MB181R	152	MB245	495	MB310R	1120	MB389R	685, 985
MB182R	161, 396	MB246	495	MB312R	662	MB398R	681, 985
MB183R	1259	MB247	495	MB313R	662	MB399R	681, 985
MB184R	1259	MB248	495	MB315R	537	MB400R	681, 985
MB185R	1260	MB249	495	MB316R	742	MB401R	681, 985
MB186R	1260	MB250	495	MB318R	672	MB402R	681, 985
MB187R	1259	MB251	495	MB320R	1120	MB403R	681, 985
MB188R	1259	MB252	495	MB322R	1120	MB404R	685, 985
MB189R	580	MB253	495	MB323R	1120	MB405R	685, 985
MB190R	658	MB254	495	MB325R	1120	MB406R	685, 985
MB191R	956	MB255	495	MB326R	1120	MB407R	685, 985
MB192R	956	MB256	496	MB328R	1120	MB408R	685, 985
MB193R	956	MB257	496	MB330R	677	MB409R	685, 985
MB194R	792	MB258	496	MB332R	580	MB410R	685, 985
MB195R	792	MB259	496	MB333R	580	MB411R	685, 985
MB196R	273, 792	MB260	496	MB335R	1120	MB412R	685, 985
MB197R	760	MB261	496	MB336R	294	MB413R	685, 985
MB198R	760	MB262	496	MB338R	114	MB415R	1003
MB199R	280, 1261	MB263	496	MB348R	462	MB416R	1003
MB200R	150	MB264	496	MB349R	470	MB417R	1003
MB203R	288	MB265	496	MB350R	460	MB418R	941
MB204R	340	MB266	496	MB352R	1259	MB448R	923
MB205R	33, 345	MB267R	1261	MB353R	1259	MB449R	927
MB206R	33, 345	MB271R	300	MB354R	1259	MB450R	579
MB207R	33, 345	MB272R	1222	MB355R	1259	MB451R	579
MB208R	85	MB273R	1226	MB356R	512	MB452R	579
MB210R	370	MB274R	287	MB357R	512	MB453R	579
MB211R	97	MB275R	973	MB358R	504	MB454R	90
MB212R	343	MB276R	973	MB359R	504	MB456R	1019
MB214R	361	MB277R	973	MB360R	504	MB458R	395
MB215R	361	MB278R	973	MB362R	361	MB459R	177
MB221R	250	MB279R	963	MB363C	777	MB460R	260
MB222R	250	MB280R	300	MB366R	739	MB462R	256
MB223	9, 882	MB281R	300	MB367R	739	MB463R	263
MB224	84	MB282R	571	MB368R	739	MB464R	263
MB225	250	MB283R	571	MB369R	739	MB465R	263
MB226	243	MB284R	289	MB370R	887	MB466R	263
MB227	86	MB285R	485	MB373R	685, 985	MB467R	263
MB229R	163	MB286R	314	MB375R	1292	MB468R	268
MB230	720	MB287R	314	MB376R	1292	MB469R	262
MB231	86	MB288R	288	MB377R	1292	MB470R	264
MB232	146	MB289R	540	MB378R	1292	MB471R	256
MB233	459	MB291R	89	MB379R	924	MB472R	256
MB234	460	MB294R	773, 836	MB380R	576	MB473R	256
MB236	87, 618	MB295R	773, 835	MB381R	576	MB474R	779
MB238R	481	MB296R	395	MB382R	576	MB475R	300

Numerical Index

MB

CATALOG NUMBER	PAGE	CATALOG NUMBER	PAGE	CATALOG NUMBER	PAGE	CATALOG NUMBER	PAGE
MB476R	278	MB539	265	MB597R	735	MB648R	761
MB477R	835	MB540R	611	MB598R	735	MB649R	761
MB481R	479	MB541	267	MB599R	735	MB650R	987
MB482R	479	MB543	268	MB600R	735	MB651R	987
MB483R	479	MB544	268	MB601R	497	MB652R	987
MB484R	102	MB545R	994	MB602R	497	MB653R	987
MB485R	102	MB546	268	MB603R	296	MB654R	987
MB486	297	MB547R	463	MB604R	63	MB655R	987
MB487R	260	MB548	269	MB605R	749, 812	MB656R	987
MB488R	261	MB549	269	MB606R	67	MB657R	983
MB489	258	MB550R	74	MB607R	67	MB658R	983
MB490	266	MB551	269	MB608R	398	MB659R	983
MB491	266	MB552	269	MB609R	117	MB660R	983
MB492	265	MB553	269	MB610R	398	MB661R	983
MB493	265	MB554R	1148	MB611R	67	MB662R	983
MB494	267	MB555	262	MB612R	67	MB663R	983
MB495	267	MB556	262	MB613R	461	MB664R	983
MB496	256	MB557	264	MB614R	577	MB665R	983
MB497	256	MB558	264	MB615R	577	MB666R	983
MB498	256	MB559	264	MB616R	577	MB667R	983
MB499R	255	MB564	256	MB617R	69	MB668R	983
MB503	259	MB565R	1148	MB618R	329	MB669R	983
MB504	259	MB566	269	MB619R	329	MB670R	260
MB506	260	MB567	269	MB620R	986	MB671R	480
MB508	261	MB568	269	MB621R	986	MB672R	480
MB509	261	MB569R	1148	MB622R	986	MB673R	480
MB510	259	MB571R	583	MB623R	986	MB674R	480
MB514R	923	MB572R	583	MB624R	986	MB675R	983
MB515	255	MB573R	251	MB625R	986	MB676R	983
MB516	255	MB574R	251	MB626R	986	MB677R	983
MB517	255	MB575A	591	MB627R	986	MB678R	983
MB518R	965	MB576R	898	MB628R	986	MB679R	983
MB519	257	MB577R	249	MB629200	988	MB680R	983
MB520	257	MB578R	249	MB629R	988	MB681R	983
MB521	257	MB579R	249	MB630R	991	MB682R	983
MB522	257	MB580R	466	MB631R	991	MB683R	983
MB523R	483	MB581R	466	MB632R	759	MB684R	983
MB524	262	MB582R	466	MB633R	759	MB685R	983
MB525	262	MB583R	1148	MB634R	497	MB686R	983
MB526	262	MB584R	200	MB635R	322, 691, 1152	MB687R	983
MB527	262	MB585R	200	MB636R	322, 691, 1152	MB688R	983
MB528R	473	MB586R	487	MB637R	249	MB689R	983
MB529	263	MB587R	487	MB638R	249	MB690R	983
MB530	263	MB588R	487	MB639R	249	MB691R	983
MB531	263	MB589R	487	MB640R	987	MB692R	983
MB532	263	MB590R	680	MB641R	987	MB693R	983
MB533R	715	MB591R	680	MB642R	987	MB694R	983
MB534	264	MB592R	680	MB643R	987	MB697R	298
MB535	264	MB593R	680	MB644R	987	MB698R	298
MB536R	963	MB594R	680	MB645R	987	MB699R	298
MB537	265	MB595R	735	MB646R	987	MB700R	508
MB538	265	MB596R	735	MB647R	789	MB701R	508

CATALOG NUMBER	PAGE	CATALOG NUMBER	PAGE	CATALOG NUMBER	PAGE	CATALOG NUMBER	PAGE
MB702R.....	508	MB764R.....	1272	MB817R.....	960	MB873R.....	1003
MB703R.....	508	MB765R.....	1272	MB818R.....	971	MB874R.....	1003
MB707R.....	981	MB766R.....	205	MB819R.....	971	MB875R.....	1003
MB708R.....	1148	MB767R.....	205	MB820R.....	971	MB876R.....	1003
MB709R.....	981	MB768R.....	205	MB821R.....	260	MB877R.....	1003
MB710R.....	981	MB769R.....	205	MB822R.....	261	MB878R.....	1003
MB711R.....	981	MB770R.....	1252	MB823R.....	260	MB879R.....	1003
MB712R.....	981	MB771R.....	1252	MB824R.....	261	MB880R.....	1003
MB713R.....	981	MB772R.....	285	MB825R.....	257	MB881R.....	1321
MB714R.....	981	MB773R.....	285	MB826R.....	257	MB882R.....	1321
MB715R.....	981	MB774R.....	286	MB827R.....	257	MB883R.....	1321
MB716R.....	981	MB775R.....	286	MB828R.....	257	MB884R.....	1321
MB717R.....	981	MB776R.....	286	MB829A.....	264	MB885R.....	192
MB718R.....	981	MB777R.....	273, 792	MB830A.....	264	MB886R.....	192
MB719R.....	981	MB778R.....	273, 792	MB832R.....	268	MB887R.....	192
MB720R.....	981	MB779R.....	103	MB833A.....	268	MB888R.....	192
MB721R.....	981	MB780R.....	103	MB834A.....	268	MB889R.....	192
MB722R.....	981	MB781R.....	103	MB835A.....	268	MB890R.....	192
MB723R.....	981	MB782R.....	103	MB838R.....	1321	MB891R.....	192
MB726R.....	32, 1207	MB783R.....	103	MB839R.....	1321	MB892R.....	291
MB727R.....	197, 788	MB785R.....	213, 723	MB840R.....	1321	MB893R.....	430
MB728R.....	197, 788	MB786R.....	1259	MB841R.....	1266	MB894R.....	430
MB729R.....	197, 788	MB787R.....	1259	MB842R.....	283	MB895R.....	430
MB730R.....	197, 788	MB788R.....	1259	MB843R.....	283	MB896R.....	430
MB731R.....	197, 788	MB789R.....	1259	MB844R.....	283	MB897R.....	185
MB732R.....	197, 788	MB790R.....	1259	MB845R.....	283	MB898R.....	185
MB733R.....	197, 788	MB791R.....	876	MB846R.....	283	MB899R.....	185
MB737R.....	487	MB792R.....	1259	MB847R.....	283	MB904R.....	144
MB738R.....	487	MB793R.....	1259	MB848R.....	283	MB906R.....	1253
MB739R.....	487	MB794R.....	1259	MB849R.....	283	MB907R.....	1253
MB740R.....	487	MB795R.....	85, 371	MB850R.....	974	MB908R.....	158
MB741R.....	485	MB796R.....	993	MB851R.....	974	MB909R.....	158
MB742R.....	984	MB797R.....	1253	MB852R.....	974	MB910R.....	107
MB743R.....	462	MB798R.....	993	MB853R.....	974	MB911R.....	112
MB744R.....	462	MB799R.....	696	MB854R.....	974	MB912R.....	205
MB745R.....	462	MB800R.....	993	MB855R.....	974	MB913R.....	205
MB746R.....	462	MB801R.....	993	MB856R.....	974	MB914R.....	205
MB747R.....	462	MB802R.....	993	MB857R.....	974	MB915R.....	371
MB748R.....	214	MB803R.....	81	MB858R.....	974	MB916R.....	371
MB749R.....	1252	MB804R.....	87	MB859R.....	974	MB917R.....	303
MB750R.....	431	MB805R.....	1321	MB860R.....	263	MB918R.....	70
MB751R.....	431	MB806R.....	1321	MB861R.....	263	MB919R.....	316
MB752R.....	431	MB807R.....	158	MB862R.....	263	MB920R.....	316
MB753R.....	1252	MB808R.....	182	MB863R.....	263	MB921R.....	84
MB754R.....	1252	MB809R.....	1321	MB864R.....	263	MB922R.....	84
MB757R.....	1252	MB810R.....	1321	MB865R.....	263	MB923R.....	85
MB758R.....	515	MB811R.....	1321	MB866R.....	263	MB924R.....	182
MB759R.....	1271	MB812R.....	499	MB867R.....	263	MB926R.....	19
MB760R.....	1271	MB813R.....	1321	MB869R.....	263	MB927R.....	311
MB761R.....	1271	MB814R.....	1321	MB870R.....	271	MB928R.....	311
MB762R.....	1273	MB815R.....	1321	MB871R.....	266	MB929R.....	280
MB763R.....	1273	MB816R.....	960	MB872R.....	1003	MB930R.....	224

Numerical Index

MB - MD

CATALOG NUMBER	PAGE	CATALOG NUMBER	PAGE	CATALOG NUMBER	PAGE	CATALOG NUMBER	PAGE
MB931R	137, 1258	MB994R	974	MD143	1108	MD393R	1009
MB932R	137, 1258	MB995R	974	MD144	1108	MD394R	1009
MB933R	507	MB996R	974	MD145	1109	MD410	1276
MB934R	789	MB997R	300	MD146	1109	MD411	1276
MB935R	1276			MD147	1109	MD450	162
MB936R	262	MD025	796	MD148	1109	MD452R	391
MB937R	262	MD064R	1286	MD216R	1008	MD453R	391
MB938A	262	MD065R	1286	MD217R	1008	MD454R	391
MB939A	262	MD066R	1286	MD218R	1008	MD455	916
MB940A	262	MD067R	1286	MD219R	1008	MD456R	74
MB941A	262	MD068R	1286	MD220R	1008	MD463	94
MB942A	262	MD069R	1286	MD221R	1008	MD464	168
MB943A	262	MD070R	1286	MD222R	1008	MD465R	168
MB954A	263	MD071R	234	MD223R	1008	MD466R	168
MB955A	263	MD072R	234	MD224R	1008	MD467R	168
MB956A	263	MD076	234	MD225R	1008	MD468	168
MB957A	263	MD077	234	MD226R	1008	MD469	168
MB958A	263	MD091	320	MD227R	1008	MD470	113
MB959A	263	MD092	320	MD234R	1008	MD471	273, 792
MB960R	271	MD093	320	MD235R	1008	MD472	1288
MB961R	271	MD094	320	MD236R	1008	MD473	1002
MB962A	270	MD095	320	MD237R	1008	MD474	1002
MB963A	270	MD096	320	MD238R	1008	MD475	1002
MB964A	270	MD097	320	MD239R	1008	MD476	1002
MB965A	270	MD098	320	MD240R	1008	MD477	1002
MB966A	270	MD099	320	MD241R	1008	MD478	1002
MB967A	270	MD111	1165	MD242R	1008	MD479	1002
MB968R	265	MD112	1165	MD243R	1008	MD480	1002
MB969R	265	MD113	1165	MD244R	1008	MD481	1002
MB970A	265	MD114	1165	MD245R	1008	MD482	1002
MB971R	516	MD115	1165	MD309R	1009	MD483	1002
MB972R	516	MD116	1165	MD310R	1009	MD484	1002
MB973R	258	MD124300	318, 690, 798	MD311R	1009	MD485	1002
MB974R	941	MD124R	318, 690, 798	MD312R	1009	MD486	1002
MB975R	941	MD125300	318, 690, 798	MD313R	1009	MD487	1002
MB976R	918	MD125R	318, 690, 798	MD314R	1009	MD488	1002
MB977R	918	MD127300	318, 690, 798	MD315R	1009	MD489	1002
MB978R	961	MD127R	318, 690, 798	MD316R	1009	MD490	1002
MB979R	961	MD129300	318, 690, 798	MD317R	1009	MD491	1205
MB980R	961	MD129R	318, 690, 798	MD318R	1009	MD496	33, 345
MB981R	961	MD131	1106	MD319R	1009	MD497	195
MB982R	686	MD132	1106	MD320R	1009	MD498	235
MB983R	1065	MD133	1107	MD383R	1009	MD500R	1010
MB984R	196	MD134	1107	MD384R	1009	MD501R	1010
MB985R	779	MD135	1107	MD385R	1009	MD502R	1010
MB986R	310, 1073	MD136	1107	MD386R	1009	MD503R	1010
MB987R	1260	MD137	1107	MD387R	1009	MD504R	1010
MB988R	1260	MD138	1107	MD388R	1009	MD505R	1010
MB989R	950	MD139	1108	MD389R	1009	MD506R	1010
MB991R	974	MD140	1108	MD390R	1009	MD507R	1010
MB992R	974	MD141	1108	MD391R	1009	MD508R	1010
MB993R	974	MD142	1108	MD392R	1009	MD509R	1010

Numerical Index

MD - MF

CATALOG NUMBER	PAGE	CATALOG NUMBER	PAGE	CATALOG NUMBER	PAGE	CATALOG NUMBER	PAGE
MD510R	1010	MD598	1285	MD664R	1011	MF125R	1137
MD511R	1010	MD605	1117	MD665R	1011	MF126R	1137
MD512R	919	MD610	497	MD666R	1011	MF127R	1137
MD513R	919	MD611	497	MD667R	1011	MF128R	1137
MD514R	919	MD613	739, 798	MD668R	1011	MF130R	1127
MD527R	949	MD613001	739, 798	MD669R	1011	MF131R	1127
MD528R	949	MD615	1027	MD887	576	MF132R	1127
MD529R	949	MD617	702, 1024	MD888	576	MF133R	1150
MD530R	949	MD618	1040	MD889	576	MF134R	1150
MD531R	1065	MD619	1040			MF135R	1150
MD534R	1065	MD620R	1010	MF054R	1047	MF136R	1056
MD536R	1079	MD621R	1010	MF055R	1047	MF137R	1129
MD537R	1040	MD622R	1010	MF056R	1124	MF138R	1122
MD538R	1040	MD623R	1010	MF057R	1156	MF139R	1154
MD539R	1040	MD624R	1010	MF058R	925	MF140R	1154
MD540R	1148	MD625R	1010	MF059R	925	MF141R	1154
MD541R	1148	MD626R	1010	MF060R	925	MF142R	1121
MD542R	1148	MD627R	1010	MF061R	947	MF143R	1121
MD543R	1148	MD628R	1010	MF065R	947	MF144R	1121
MD544R	1148	MD629R	1010	MF066R	947	MF145R	1121
MD545R	1148	MD630R	1010	MF067R	947	MF146R	1124
MD546R	1148	MD631R	1010	MF068R	947	MF147R	1124
MD547R	1148	MD632R	1010	MF069R	947	MF148R	1124
MD548R	1148	MD633R	1010	MF070R	947	MF250	1016
MD549R	1148	MD634R	1010	MF071R	947	MF251R	1016
MD550R	1148	MD635R	1010	MF072R	947	MF252R	1016
MD551R	1148	MD636R	1010	MF073R	947	MF253R	1016
MD552R	1148	MD637R	1010	MF074R	947	MF254R	1016
MD553R	1148	MD638R	1010	MF075R	947	MF255R	1016
MD554R	1148	MD639R	1010	MF076R	947	MF256R	1016
MD555R	1148	MD640R	1010	MF077R	947	MF257R	1016
MD556R	1148	MD641R	1010	MF078R	947	MF258R	1016
MD557R	1121	MD642R	1010	MF079R	947	MF259R	1016
MD562	506, 1122	MD643R	1010	MF106R	315, 1149	MF260R	1016
MD563	939	MD645	966	MF107R	315, 1149	MF261R	1016
MD565	1000	MD646	966	MF108R	315, 1149	MF262R	1016
MD566	1000	MD647	966	MF109R	315, 1149	MF263R	1016
MD567	1000	MD648	966	MF110R	315, 1149	MF264R	1016
MD568	109	MD649	966	MF111R	315, 1149	MF265R	1016
MD569	174	MD651	281, 1261	MF112R	1137	MF266R	1016
MD570R	174	MD652	189, 391	MF113R	1137	MF267R	1016
MD579R	1285	MD653	189, 391	MF114R	1137	MF268R	1016
MD580	834	MD654	189, 391	MF115R	1137	MF269R	1016
MD581	190, 785	MD655R	1011	MF116R	1137	MF270R	1016
MD582	126	MD656R	1011	MF117R	1137	MF271	1016
MD591	1252	MD657R	1011	MF118R	1137	MF272R	1016
MD592	1252	MD658R	1011	MF119R	1137	MF273R	1016
MD593R	1285	MD659R	1011	MF120R	1137	MF274R	1016
MD594	1285	MD660R	1011	MF121R	1137	MF275R	1016
MD595	1285	MD661R	1011	MF122R	1137	MF276R	1016
MD596	1285	MD662R	1011	MF123R	1137	MF277R	1016
MD597	1285	MD663R	1011	MF124R	1137	MF278R	1016

Numerical Index

MF

CATALOG NUMBER	PAGE	CATALOG NUMBER	PAGE	CATALOG NUMBER	PAGE	CATALOG NUMBER	PAGE
MF279R.....	1016	MF331R.....	948	MF383T.....	955	MF446R.....	1041
MF280R.....	1016	MF332R.....	948	MF384T.....	955	MF447R.....	1041
MF281R.....	1016	MF333R.....	315, 1149	MF385T.....	955	MF448R.....	1048
MF282R.....	1016	MF334R.....	315, 1149	MF386T.....	955	MF449R.....	1048
MF283R.....	1016	MF335R.....	315, 1149	MF387T.....	955	MF450R.....	1049
MF284R.....	1016	MF336R.....	315, 1149	MF388T.....	955	MF451R.....	1049
MF285R.....	1016	MF337R.....	315, 1149	MF389T.....	955	MF452R.....	1049
MF286R.....	1016	MF338R.....	315, 1149	MF390T.....	955	MF453R.....	1122
MF287R.....	1016	MF339R.....	315, 1149	MF391T.....	955	MF454R.....	1122
MF288R.....	1016	MF340R.....	315, 1149	MF392.....	953	MF455R.....	1116
MF289R.....	1016	MF341R.....	315, 1149	MF393.....	953	MF456R.....	1047
MF290R.....	1016	MF342R.....	315, 1149	MF401R.....	1155	MF457R.....	1047
MF291R.....	1016	MF343R.....	315, 1149	MF402R.....	1155	MF458R.....	983
MF292R.....	1016	MF344R.....	315, 1149	MF403R.....	1155	MF459R.....	983
MF293R.....	1016	MF345R.....	315, 1149	MF404R.....	1155	MF460R.....	983
MF294R.....	1016	MF346R.....	315, 1149	MF405R.....	1153	MF461R.....	983
MF295.....	1017	MF347R.....	315, 1149	MF406R.....	1153	MF462R.....	1047
MF296R.....	1017	MF348R.....	1165	MF410R.....	1141	MF463R.....	1047
MF297R.....	1017	MF349R.....	1165	MF411R.....	1047	MF464R.....	1049
MF298R.....	1017	MF350R.....	1165	MF412R.....	1110	MF465R.....	979
MF299R.....	1017	MF351R.....	1165	MF413R.....	1110	MF466R.....	979
MF300R.....	1017	MF352R.....	1165	MF414R.....	1110	MF467R.....	979
MF301R.....	1017	MF353R.....	1165	MF415R.....	1110	MF468R.....	979
MF302R.....	1017	MF354R.....	1165	MF416R.....	1110	MF469R.....	979
MF303R.....	1017	MF355R.....	1165	MF417R.....	1110	MF470R.....	979
MF304R.....	1017	MF356R.....	1165	MF418R.....	1110	MF471R.....	979
MF305R.....	1017	MF357R.....	1165	MF419R.....	1111	MF472R.....	979
MF306R.....	1017	MF358R.....	1165	MF420R.....	1111	MF473R.....	979
MF307R.....	1017	MF359R.....	1165	MF421R.....	1111	MF474R.....	979
MF308R.....	1017	MF360R.....	1109	MF422R.....	1111	MF475R.....	979
MF309R.....	1017	MF361R.....	1109	MF423R.....	1111	MF476R.....	979
MF310R.....	1017	MF362R.....	1109	MF424R.....	1111	MF477R.....	979
MF311R.....	1017	MF363R.....	1106	MF425R.....	1111	MF478R.....	979
MF312R.....	1017	MF364R.....	1106	MF426R.....	1112	MF479R.....	319, 1150
MF313R.....	1017	MF365T.....	954	MF427R.....	1112	MF480R.....	319, 1150
MF314R.....	1017	MF366T.....	954	MF429R.....	1048	MF481R.....	319, 1150
MF315R.....	1017	MF367T.....	955	MF430R.....	1048	MF482R.....	319, 1150
MF316R.....	1017	MF368T.....	955	MF431R.....	1048	MF483R.....	319, 1150
MF317R.....	1017	MF369T.....	955	MF432R.....	1048	MF484R.....	319, 1150
MF318R.....	1017	MF370T.....	955	MF433R.....	1048	MF485R.....	319, 1150
MF319R.....	1017	MF371T.....	955	MF434R.....	1048	MF486R.....	319, 1150
MF320.....	1016, 1017, 1018	MF372T.....	955	MF435R.....	1048	MF487R.....	319, 1150
MF321R.....	1016	MF373T.....	955	MF436R.....	1048	MF488R.....	319, 1150
MF322R.....	1016	MF374T.....	955	MF437R.....	1048	MF489R.....	319, 1151
MF323R.....	1016	MF375T.....	955	MF438R.....	1048	MF490R.....	319, 1151
MF324R.....	1124	MF376T.....	955	MF439R.....	1143	MF491R.....	319, 1151
MF325R.....	1124	MF377T.....	955	MF440R.....	1143	MF492R.....	319, 1151
MF326R.....	1153	MF378T.....	955	MF441R.....	1143	MF493R.....	319, 1151
MF327R.....	1153	MF379T.....	955	MF442R.....	948	MF494R.....	319, 1151
MF328R.....	1153	MF380T.....	955	MF443R.....	948	MF495R.....	319, 1151
MF329R.....	948	MF381T.....	955	MF444R.....	1048	MF496R.....	319, 1151
MF330R.....	948	MF382T.....	955	MF445R.....	1048	MF497R.....	319, 1151

CATALOG NUMBER	PAGE	CATALOG NUMBER	PAGE	CATALOG NUMBER	PAGE	CATALOG NUMBER	PAGE
MF498R.....	319, 1151	MF550R.....	1002	MF602R.....	1049	MG055R.....	494
MF499R.....	319, 1150	MF551R.....	1002			MG056R.....	1029
MF500R.....	319, 1150	MF552R.....	1002	MG001R.....	324	MG057R.....	1029
MF501R.....	319, 1150	MF553R.....	1002	MG002R.....	324	MG058R.....	1029
MF502R.....	319, 1150	MF554R.....	1002	MG003R.....	324	MG059R.....	702, 1024
MF503R.....	319, 1150	MF555R.....	1002	MG004R.....	324	MG060R.....	1027
MF504R.....	319, 1150	MF556R.....	1002	MG005R.....	770	MG061R.....	524
MF505R.....	319, 1150	MF557R.....	1002	MG006R.....	770	MG062R.....	523
MF506R.....	319, 1150	MF558R.....	1002	MG007R.....	277	MG063R.....	527
MF507R.....	319, 1150	MF559R.....	1002	MG008R.....	494	MG064R.....	946
MF508R.....	319, 1150	MF560R.....	1002	MG009R.....	494	MG065R.....	252
MF509R.....	319, 1151	MF561R.....	1002	MG010R.....	494	MG066R.....	1315
MF510R.....	319, 1151	MF562R.....	1002	MG011R.....	494	MG067R.....	513
MF511R.....	319, 1151	MF563R.....	1002	MG012R.....	478	MG070R.....	361
MF512R.....	319, 1151	MF564R.....	1002	MG013R.....	478	MG071R.....	367
MF513R.....	319, 1151	MF565R.....	1002	MG014R.....	431	MG072R.....	54
MF514R.....	319, 1151	MF566R.....	1002	MG015R.....	525	MG073R.....	478
MF515R.....	319, 1151	MF567R.....	1002	MG016R.....	530	MG074R.....	421
MF516R.....	319, 1151	MF568R.....	1002	MG017R.....	531	MG075R.....	403
MF517R.....	319, 1151	MF569R.....	1002	MG018R.....	531	MG076R.....	1249
MF518R.....	319, 1151	MF570R.....	1002	MG019R.....	531	MG077R.....	83
MF519R.....	1002	MF571R.....	1002	MG020R.....	532	MG078R.....	85, 371
MF520R.....	1002	MF572R.....	1002	MG021R.....	995	MG079R.....	1314
MF521R.....	1002	MF573R.....	1002	MG024R.....	964	MG080R.....	1314
MF522R.....	1002	MF574R.....	1002	MG025R.....	891	MG081R.....	956
MF523R.....	1002	MF575R.....	1002	MG026R.....	895	MG082R.....	483
MF524R.....	1002	MF576R.....	1002	MG028R.....	896	MG083R.....	483
MF525R.....	1002	MF577R.....	1002	MG029R.....	891	MG084R.....	483
MF526R.....	1002	MF578R.....	1002	MG030R.....	984	MG085R.....	164
MF527R.....	1002	MF579R.....	1002	MG031R.....	984	MG086R.....	597
MF528R.....	1002	MF580R.....	1002	MG032R.....	984	MG087R.....	46
MF529R.....	1002	MF581R.....	1002	MG033R.....	984	MG088R.....	893
MF530R.....	1002	MF582R.....	1002	MG034R.....	984	MG089R.....	893
MF531R.....	1002	MF583R.....	1002	MG035R.....	984	MG090R.....	893
MF532R.....	1002	MF584R.....	1002	MG036R.....	984	MG091R.....	779
MF533R.....	1002	MF585R.....	1002	MG037R.....	986	MG092200.....	316
MF534R.....	1002	MF586R.....	1002	MG038R.....	986	MG092R.....	316
MF535R.....	1002	MF587R.....	1002	MG039R.....	986	MG094R.....	503
MF536R.....	1002	MF588R.....	1002	MG040R.....	986	MG095R.....	993
MF537R.....	1002	MF589R.....	1002	MG041R.....	986	MG098R.....	150
MF538R.....	1002	MF590R.....	1002	MG042R.....	986	MG100R.....	322, 616
MF539R.....	1002	MF591R.....	1002	MG043R.....	986	MG101R.....	322, 616
MF540R.....	1002	MF592R.....	1002	MG044R.....	986	MG102R.....	322, 616
MF541R.....	1002	MF593R.....	1002	MG046R.....	986	MG103R.....	322, 616
MF542R.....	1002	MF594R.....	1002	MG047R.....	986	MG104R.....	322, 616
MF543R.....	1002	MF595R.....	1002	MG048R.....	986	MG105R.....	322, 616
MF544R.....	1002	MF596R.....	1002	MG049R.....	986	MG106R.....	322, 616
MF545R.....	1002	MF597R.....	1002	MG050R.....	986	MG107R.....	322, 616
MF546R.....	1002	MF598R.....	1002	MG051R.....	496	MG108R.....	322, 616
MF547R.....	1002	MF599R.....	1002	MG052R.....	496	MG109R.....	322, 616
MF548R.....	1002	MF600R.....	1049	MG053R.....	496	MG110R.....	322, 616
MF549R.....	1002	MF601R.....	1049	MG054R.....	496	MG111R.....	1322

Numerical Index

MG

CATALOG NUMBER	PAGE	CATALOG NUMBER	PAGE	CATALOG NUMBER	PAGE	CATALOG NUMBER	PAGE
MG112R.....	1322	MG168R.....	296	MG240R.....	1319	MG366R.....	54
MG113R.....	1322	MG169R.....	296	MG241R.....	1319	MG368R.....	434
MG114R.....	1322	MG170R.....	298	MG242R.....	1319	MG369R.....	507
MG115R.....	1322	MG175R.....	1279	MG243R.....	1319	MG370R.....	785
MG116R.....	1322	MG176R.....	281, 1261	MG244R.....	1319	MG371R.....	946
MG117R.....	1322	MG177R.....	281, 1261	MG245R.....	1319	MG374R.....	235, 663
MG118R.....	1322	MG178R.....	285	MG246R.....	1319	MG375R.....	576
MG119R.....	1322	MG179R.....	1315	MG247R.....	1319	MG377R.....	324
MG120R.....	1322	MG180R.....	1317	MG248R.....	1316	MG378R.....	324
MG121R.....	1322	MG181R.....	1317	MG249R.....	1316	MG379R.....	8
MG122R.....	1322	MG182R.....	252	MG250R.....	1314	MG381R.....	331
MG123R.....	1322	MG183R.....	1236	MG251R.....	1285	MG382R.....	332
MG124R.....	1322	MG184R.....	1223	MG252R.....	1285	MG383R.....	332
MG125R.....	1322	MG185R.....	1235	MG253R.....	1285	MG421R.....	393
MG126R.....	1322	MG186R.....	1238	MG254R.....	1285	MG422R.....	92
MG127R.....	1322	MG187R.....	1248	MG255R.....	1285	MG423R.....	428
MG128R.....	1319	MG189R.....	1232	MG256R.....	1285	MG426R.....	160
MG129R.....	1319	MG190R.....	1235	MG257R.....	1285	MG428R.....	372
MG130R.....	1319	MG191R.....	1235	MG258R.....	1285	MG431R.....	159
MG131R.....	1320	MG192R.....	1238	MG259R.....	1285	MG432R.....	159
MG132R.....	1320	MG193R.....	1227	MG260R.....	208	MG433R.....	140
MG133R.....	1320	MG194R.....	1250	MG261R.....	208	MG434R.....	140
MG134R.....	1320	MG195R.....	1227	MG262R.....	208	MG435R.....	111
MG135R.....	1320	MG196R.....	159	MG264R.....	208	MG436R.....	139
MG136R.....	1320	MG197R.....	159	MG265R.....	208	MG437R.....	139
MG137R.....	1320	MG198R.....	1258	MG266R.....	208	MG438R.....	139
MG138R.....	1320	MG199R.....	1258	MG267R.....	208	MG439R.....	138
MG139R.....	1320	MG200R.....	1217	MG269R.....	208	MG440R.....	371
MG140R.....	1290	MG201R.....	1240	MG270R.....	1285	MG446R.....	709
MG141R.....	1290	MG202R.....	1221	MG271R.....	311	MG448R.....	439
MG142R.....	1290	MG203R.....	1259	MG272R.....	311	MG449R.....	397
MG143R.....	1290	MG204R.....	1259	MG274R.....	195	MG451R.....	475
MG144R.....	1290	MG205R.....	1259	MG275R.....	90	MG452R.....	1311
MG145R.....	1290	MG206R.....	1259	MG276R.....	194	MG453R.....	1312
MG146R.....	1290	MG207R.....	1313	MG277R.....	194	MG454R.....	125
MG147R.....	1290	MG208R.....	1208	MG284R.....	211	MG455R.....	109
MG148R.....	1290	MG209R.....	1208	MG346R.....	342	MG456R.....	471
MG149R.....	1292	MG210R.....	1208	MG347R.....	342	MG457R.....	471
MG150R.....	797	MG211R.....	1208	MG348R.....	342	MG458R.....	471
MG151R.....	797	MG212R.....	1208	MG349R.....	342	MG460R.....	138
MG152R.....	797	MG213R.....	1208	MG350R.....	342	MG464R.....	84
MG153R.....	797	MG214R.....	1208	MG353R.....	159	MG465R.....	84
MG154R.....	797	MG215R.....	32, 1207	MG354R.....	159	MG466R.....	1240
MG155R.....	1288	MG216R.....	46	MG356R.....	103	MG467R.....	1240
MG156R.....	1265	MG218R.....	1203	MG357R.....	83	MG468R.....	1240
MG157R.....	1276	MG219R.....	1202	MG358R.....	91	MG469R.....	1240
MG158R.....	1271	MG220R.....	28	MG359R.....	112	MG471R.....	530
MG159R.....	1266	MG221R.....	300	MG360R.....	106	MG472R.....	225
MG160R.....	288	MG222R.....	300	MG361R.....	433	MG473R.....	655
MG162R.....	289	MG235R.....	108	MG362R.....	433	MG474R.....	198
MG163R.....	289	MG236R.....	108	MG363R.....	841	MG475R.....	195
MG165R.....	299	MG237R.....	108	MG364R.....	114	MG480R.....	235

CATALOG NUMBER	PAGE	CATALOG NUMBER	PAGE	CATALOG NUMBER	PAGE	CATALOG NUMBER	PAGE
MG481R.....	235	MN029R.....	1012	MN083R.....	1014	ND122R.....	979
MG482R.....	235	MN030R.....	1012	MN084R.....	1014	ND123R.....	979
MG483R.....	235	MN031R.....	1012	MN085R.....	1014	ND124R.....	979
MG484R.....	235	MN032R.....	1012	MN086R.....	1014	ND125R.....	979
MG491R.....	237	MN033R.....	1012	MN087R.....	1014		
MG492R.....	1238	MN034R.....	1012	MN088R.....	1014	OA200R.....	845
MG511R.....	258	MN035R.....	1012	MN090R.....	1040	OA218R.....	847
MG521R.....	768	MN036R.....	1012	MN091R.....	1040	OA225R.....	847
MG522R.....	62	MN037R.....	1012	MN092R.....	1040	OA310R.....	790, 849
MG571.....	296	MN038R.....	1012	MN093R.....	1040	OA311R.....	790, 849
MG574R.....	745	MN039R.....	1012	MN094R.....	1040	OA312R.....	790, 849
MG575R.....	796	MN040R.....	1012	MN095R.....	1040	OA313R.....	790, 849
MG577R.....	1030	MN041R.....	1012	MN096R.....	1040	OA314R.....	790, 849
MG578R.....	390	MN042R.....	1013	MN097R.....	1040	OA332R.....	190, 783
MG579R.....	1029	MN043R.....	1013	MN098R.....	1040	OA333R.....	190, 783
MG581R.....	1031	MN044R.....	1013	MN099R.....	1040	OA334R.....	190, 783
MG582R.....	243	MN045R.....	1013	MN100R.....	1040	OA335R.....	190, 783
MG583R.....	989	MN046R.....	1013	MN101R.....	1040	OA336R.....	191, 783
MG584R.....	675, 958	MN047R.....	1013	MN102R.....	1041	OA337R.....	191, 783
MG585R.....	243	MN048R.....	1013	MN103R.....	1041	OA338R.....	191, 783
MG586R.....	243	MN049R.....	1013	MN104R.....	1041	OA340R.....	191, 783
MG588R.....	390	MN050R.....	1013	MN105R.....	1041	OA351R.....	191, 783
MG589R.....	390	MN051R.....	1013	MN106R.....	1041	OA357R.....	785
		MN052R.....	1013	MN107R.....	1041	OA358R.....	785
MN001R.....	968	MN053R.....	1013	MN108R.....	1041	OA359R.....	785
MN002R.....	968	MN054R.....	1013	MN109R.....	1041		
MN003R.....	968	MN055R.....	1013	MN110R.....	1041	OB510.....	865
MN004R.....	968	MN056R.....	1013	MN111R.....	1042	OB511.....	865
MN005R.....	968	MN057R.....	1013	MN112R.....	1042	OB512.....	865
MN006R.....	968	MN058R.....	1013	MN113R.....	1042	OB513.....	865
MN007R.....	968	MN059R.....	1013	MN114R.....	1042	OB514.....	865
MN008R.....	968	MN060R.....	1013	MN115R.....	1042	OB793R.....	876
MN009R.....	968	MN061R.....	1013	MN116R.....	1042		
MN010R.....	968	MN062R.....	1013	MN117R.....	1042	OC020R.....	833
MN011R.....	968	MN063R.....	1013	MN118R.....	1042	OC021R.....	833
MN012R.....	1012	MN064R.....	1013	MN119R.....	1042	OC022R.....	833
MN013R.....	1012	MN065R.....	1013	MN120R.....	1043	OC024R.....	833
MN014R.....	1012	MN066R.....	1013	MN121R.....	1043	OC025R.....	833
MN015R.....	1012	MN067R.....	1013	MN122R.....	1043	OC026R.....	833
MN016R.....	1012	MN068R.....	1013	MN123R.....	1043	OC051R.....	834
MN017R.....	1012	MN069R.....	1013	MN124R.....	1043	OC091R.....	834
MN018R.....	1012	MN070R.....	1013	MN125R.....	1043	OC094R.....	834
MN019R.....	1012	MN071R.....	1013	MN126R.....	1043	OC100R.....	836
MN020R.....	1012	MN073R.....	925	MN127R.....	1043	OC415R.....	756
MN021R.....	1012	MN074R.....	925	MN128R.....	1043	OC430R.....	817
MN022R.....	1012	MN075R.....	925			OC480R.....	823
MN023R.....	1012	MN077R.....	1014	ND105R.....	980	OC482R.....	823
MN024R.....	1012	MN078R.....	1014	ND108R.....	980	OC485R.....	823
MN025R.....	1012	MN079R.....	1014	ND109R.....	980	OC486R.....	823
MN026R.....	1012	MN080R.....	1014	ND118R.....	981	OC491R.....	823
MN027R.....	1012	MN081R.....	1014	ND120R.....	979	OC492R.....	823
MN028R.....	1012	MN082R.....	1014	ND121R.....	979	OC496R.....	822

Numerical Index

OC - OK

CATALOG NUMBER	PAGE	CATALOG NUMBER	PAGE	CATALOG NUMBER	PAGE	CATALOG NUMBER	PAGE
OC497R.....	822	OF410R.....	540	OG338R.....	542	OK108R.....	666
OC498R.....	821	OF411R.....	543	OG339R.....	542	OK226R.....	622
OC499R.....	821	OF414R.....	540	OG341R.....	549	OK242R.....	621
OC500R.....	821	OF420R.....	543	OG342R.....	549	OK243R.....	621
		OF425R.....	547	OG343R.....	549	OK245R.....	621
OF001N.....	591	OF431R.....	541	OG344R.....	549	OK260R.....	650
OF002N.....	591	OF438R.....	547	OG345R.....	549	OK270R.....	650
OF003N.....	591	OF439R.....	547	OG346R.....	549	OK293R.....	650
OF004N.....	591	OF440R.....	547	OG348R.....	549	OK350R.....	599
OF005N.....	591	OF442R.....	540	OG350R.....	536	OK351R.....	599
OF006N.....	591	OF444R.....	540	OG351R.....	536	OK353R.....	603
OF101C.....	562	OF448R.....	547	OG352R.....	536	OK365R.....	596, 750
OF102C.....	562	OF505R.....	553	OG353R.....	536	OK366R.....	608, 814
OF103C.....	562	OF528R.....	553	OG355R.....	536	OK367R.....	596, 750
OF104C.....	562			OG359R.....	552	OK368R.....	596
OF111C.....	567	OG001R.....	538	OG360R.....	552	OK369R.....	596
OF112C.....	567	OG002R.....	538	OG950R.....	579	OK370R.....	601
OF113C.....	567	OG003R.....	538	OG951R.....	579	OK372R.....	601, 757
OF114C.....	567	OG007R.....	555			OK373R.....	601, 757
OF115C.....	566	OG008R.....	555	OK030R.....	670	OK374R.....	596
OF116C.....	566	OG009R.....	555	OK041R.....	670	OK378R.....	1063
OF117C.....	566	OG010R.....	555	OK042R.....	670	OK400R.....	624
OF120C.....	562	OG011R.....	555	OK043R.....	670	OK405R.....	624
OF121C.....	562	OG012R.....	555	OK047R.....	671	OK422R.....	623
OF122C.....	562	OG013R.....	555	OK048R.....	671	OK440R.....	623
OF123C.....	562	OG014R.....	555	OK049R.....	671	OK441R.....	623
OF124C.....	562	OG050R.....	582	OK051R.....	671	OK442R.....	623
OF268R.....	587	OG100R.....	569	OK052R.....	671	OK443R.....	623
OF271R.....	585	OG101R.....	572	OK053R.....	672	OK505R.....	641
OF272R.....	585	OG108R.....	573	OK058R.....	672	OK506R.....	641
OF277R.....	555	OG110R.....	573	OK060R.....	669	OK507R.....	641
OF278R.....	555	OG112R.....	573	OK061R.....	669	OK508R.....	641
OF279R.....	555	OG123R.....	574	OK062R.....	669	OK509R.....	641
OF282R.....	555	OG124R.....	574	OK081R.....	667	OK520R.....	641
OF283R.....	555	OG133R.....	573	OK082R.....	667	OK521R.....	641
OF284R.....	555	OG136R.....	573	OK083R.....	667	OK522R.....	641
OF285R.....	555	OG145R.....	593	OK084R.....	667	OK525R.....	631
OF300R.....	541	OG163R.....	659	OK085R.....	665	OK526R.....	631
OF303R.....	541	OG164R.....	659	OK089R.....	665	OK527R.....	645
OF350R.....	585	OG180R.....	588	OK090R.....	665	OK529R.....	645
OF351R.....	585	OG181R.....	587	OK091R.....	668	OK530R.....	644
OF352R.....	585	OG182R.....	587	OK092R.....	668	OK531R.....	645
OF353R.....	585	OG184R.....	587	OK093R.....	668	OK544R.....	643
OF354R.....	585	OG185R.....	587	OK094R.....	668	OK545R.....	643
OF355R.....	585	OG189R.....	587	OK099R.....	652	OK546R.....	643
OF356R.....	585	OG300R.....	550	OK100R.....	673, 1127	OK612R.....	625
OF357R.....	585	OG301R.....	550	OK101R.....	673, 1127	OK613R.....	625
OF358R.....	585	OG325R.....	542	OK102R.....	673, 1127	OK711R.....	629
OF359R.....	585	OG330R.....	542	OK103R.....	673, 1127	OK712R.....	629
OF403R.....	539	OG331R.....	542	OK105R.....	666	OK737R.....	630
OF405R.....	539	OG332R.....	542	OK106R.....	666	OK740R.....	629
OF407R.....	540	OG335R.....	542	OK107R.....	666	OK741R.....	629

CATALOG NUMBER	PAGE	CATALOG NUMBER	PAGE	CATALOG NUMBER	PAGE	CATALOG NUMBER	PAGE
OK742R.....	629	OL275R.....	682	OL409R.....	676, 959	OM085R.....	744
OK745R.....	630	OL294R.....	681	OL410R.....	674	OM086R.....	744
OK794R.....	656	OL296R.....	681	OL411R.....	674	OM087R.....	744
OK795R.....	656	OL298R.....	681	OL412R.....	675	OM088R.....	744
OK804R.....	674	OL299R.....	681	OL423R.....	958	OM089R.....	744
OK805R.....	674	OL300R.....	681	OL425R.....	958	OM090R.....	744
OK811R.....	696	OL301R.....	678	OL427R.....	958	OM101R.....	735
OK812R.....	696	OL302R.....	678	OL429R.....	958	OM102R.....	735
OK813R.....	696	OL303R.....	678	OL448R.....	676	OM103R.....	735
OK814R.....	696	OL304R.....	678	OL451R.....	676	OM104201.....	735
OK815R.....	696	OL305R.....	682	OL452R.....	676	OM104R.....	735
OK816R.....	696	OL307R.....	801	OL460R.....	649	OM112R.....	733
OK874C.....	691	OL311R.....	679	OL470R.....	648	OM113R.....	733
OK875C.....	691	OL314R.....	679	OL471R.....	648	OM114R.....	733
OK900.....	692	OL316R.....	679	OL472R.....	648	OM115R.....	733
		OL318R.....	678	OL473R.....	648	OM116R.....	733
OL101R.....	622	OL321R.....	684	OL474R.....	649	OM118R.....	733
OL102R.....	688	OL322R.....	684	OL477R.....	658	OM119R.....	733
OL104R.....	688	OL323R.....	684	OL479R.....	658	OM169R.....	734
OL107R.....	688	OL326R.....	681	OL601R.....	192, 784	OM170.....	731, 733-734
OL109R.....	687	OL327R.....	681	OL602R.....	192, 784	OM171R.....	736
OL111R.....	688	OL328R.....	681	OL603R.....	192, 784	OM172R.....	736
OL113R.....	687	OL329R.....	681	OL610R.....	191, 784	OM173R.....	736
OL120R.....	688	OL336R.....	679	OL611R.....	191, 784	OM174R.....	736
OL151R.....	662	OL338R.....	684	OL612R.....	191, 784	OM175R.....	736
OL152R.....	660	OL339R.....	684	OL615R.....	191	OM176R.....	736
OL153R.....	662	OL344R.....	683	OL617R.....	192, 784	OM177R.....	736
OL155R.....	660	OL345R.....	683	OL619R.....	192, 784	OM178R.....	736
OL157R.....	660	OL346R.....	683	OL620R.....	190, 785	OM179R.....	734
OL160R.....	664	OL347R.....	683	OL621R.....	190, 785	OM181R.....	737
OL162R.....	661	OL348R.....	683	OL622R.....	190, 785	OM182R.....	737
OL163R.....	661	OL349R.....	683	OL623R.....	190, 785	OM183R.....	737
OL165R.....	661	OL350R.....	683	OL624R.....	190, 785	OM186R.....	737
OL166R.....	661	OL354R.....	687	OL626R.....	1117	OM187R.....	737
OL168R.....	692, 798	OL355R.....	687	OL627R.....	1118	OM235R.....	722
OL170R.....	663	OL356R.....	687	OL670R.....	797	OM236R.....	722
OL171R.....	663	OL360R.....	682			OM237R.....	722
OL192R.....	659	OL361R.....	682	OM038R.....	729	OM307R.....	664
OL198R.....	662	OL362R.....	682	OM040R.....	729	OM308R.....	664
OL201R.....	651	OL363R.....	682	OM041R.....	730	OM309R.....	664
OL202R.....	655	OL366R.....	682	OM047R.....	730	OM391R.....	726
OL203R.....	654	OL367R.....	682	OM070R.....	730	OM392R.....	726
OL204R.....	654	OL368R.....	682	OM071R.....	730	OM393R.....	726
OL207R.....	651	OL369R.....	682	OM072R.....	730	OM396R.....	726
OL211R.....	655, 790	OL370R.....	682	OM073R.....	730	OM397R.....	726
OL212R.....	655, 790	OL371R.....	682	OM078R.....	744	OM398R.....	726
OL214R.....	654	OL401R.....	676	OM079R.....	744	OM451R.....	740
OL270R.....	682	OL403R.....	676	OM080R.....	744	OM452R.....	740
OL271R.....	682	OL405R.....	675, 958	OM081R.....	744	OM453R.....	740
OL272R.....	682	OL406R.....	675, 958	OM082R.....	744	OM454R.....	740
OL273R.....	682	OL407R.....	677, 959	OM083R.....	744	OM455R.....	740
OL274R.....	682	OL408R.....	676, 959	OM084R.....	744	OM456R.....	740

Numerical Index

OM - US

CATALOG NUMBER	PAGE	CATALOG NUMBER	PAGE	CATALOG NUMBER	PAGE	CATALOG NUMBER	PAGE
OM471R.....	740	SF811R.....	709	US149.....	742	US300.....	1177
OM472R.....	740	SF812R.....	615	US150.....	742	US301.....	1177
OM473R.....	740	SF813R.....	709	US152.....	129	US302.....	1186
OM474R.....	740			US153SU.....	1195	US303.....	1186
OM500R.....	740	SR580R.....	1295	US154SU.....	1195	US304.....	1186
OM501R.....	740			US155SU.....	1195	US305.....	1177
OM502R.....	740	TA005771.....	730	US156SU.....	1195	US306.....	1187
OM503R.....	740	TA009706.....	729	US157SU.....	1195	US307.....	1177
OM504R.....	740			US158SU.....	1195	US308.....	1177
OM505R.....	740	TE749R.....	673, 1128	US159.....	1185	US309.....	1178
OM510R.....	741			US161.....	1183	US310.....	1178
OM511R.....	741	US060.....	325	US162.....	1183	US311.....	1186
OM512R.....	741	US061.....	325	US163.....	1183	US314.....	1179
OM513R.....	741	US062.....	325	US164.....	1183	US315.....	1179
OM514R.....	741	US063.....	325	US165.....	1183	US316.....	1179
OM602R.....	716	US064.....	325	US166.....	1193	US317.....	1179
OM611R.....	717	US065.....	325	US167.....	1193	US318.....	1179
OM612R.....	716	US066.....	325	US168.....	1193	US319.....	1179
OM613R.....	716	US067.....	325	US169.....	1193	US320.....	1179
OM660R.....	725	US100.....	1262	US170.....	1193	US321.....	1179
OM661R.....	725	US100201.....	1262	US171.....	1187	US322.....	1179
OM668R.....	725	US100202.....	1262	US172.....	1187	US323.....	1179
OM671200.....	316	US101.....	562	US173.....	1174	US324.....	1179
OM671R.....	316	US102.....	562	US174.....	1191	US325.....	1179
OM681R.....	738	US103.....	562	US175.....	1183	US326.....	1184
OM688R.....	738	US104.....	87	US176.....	1187	US327.....	1184
OM700R.....	706	US105.....	87	US177.....	1187	US328.....	1184
OM707R.....	706	US106.....	322	US178.....	1185	US329.....	1184
OM750R.....	728	US107.....	322	US179.....	1186	US330.....	1183
OM751R.....	728	US109.....	102	US182.....	1177	US331.....	1183
OM760R.....	726	US110.....	102	US183.....	1177	US332.....	1183
OM761R.....	726	US111.....	104	US184.....	1178	US333.....	1183
OM776R.....	728	US112.....	102	US185.....	1178	US335.....	1185
OM781R.....	728	US114.....	117	US186.....	1178	US336.....	1185
		US115.....	117	US187.....	1178	US337.....	1185
OP299.....	730	US116.....	184	US188.....	1178	US338.....	1185
OP300R.....	710	US117.....	103	US189.....	1178	US339.....	1186
OP301R.....	710	US118.....	103	US190.....	1191	US340.....	1186
OP302R.....	710	US119.....	103	US191.....	1191	US341.....	1187
OP304R.....	710	US120.....	103	US192.....	1192	US342.....	1177
OP305R.....	710	US123.....	457	US193.....	1192	US344.....	1186
OP306R.....	710	US124.....	457	US194.....	1192	US345.....	1184
OP307R.....	710	US125.....	457	US195.....	1192	US346.....	1184
OP310R.....	708	US126.....	360	US196.....	1186	US347.....	1184
OP311R.....	708	US133.....	834	US197.....	1186	US348.....	1184
OP312R.....	708	US136.....	835	US200.....	340	US349SP.....	1199
OP313R.....	708	US137.....	828	US201SU.....	1196	US351.....	1199
OP360R.....	739	US138.....	828	US202SU.....	1196	US352.....	1200
OP361R.....	739	US141.....	817	US203SU.....	1196	US353.....	1200
OP362R.....	739	US142.....	989	US204SU.....	1196	US355.....	1200
		US145.....	331	US205SU.....	1196	US356.....	1200
		US147.....	86	US206SU.....	1196	US359.....	1199

Numerical Index

US - XG

CATALOG NUMBER	PAGE	CATALOG NUMBER	PAGE	CATALOG NUMBER	PAGE	CATALOG NUMBER	PAGE
US360	1193	US548	1176	US617	1174		
US361	1193	US556	1192	US618	1174		
US362	1193	US557	1192	US619	1174		
US363	1193	US558	1192	US620	1174		
US366	1192	US559SU	1196	US621	1174		
US367	1192	US560SU	1195	US622	1191		
US368	1192	US561SU	1196	US623	1191		
US369	1191	US562SU	1195	US624	1191		
US370	1191	US563SU	1196	US625	1191		
US372	1193	US564SU	1196	US626	1191		
US382	1192	US565SU	1196	US627	1191		
US385	1192	US566SU	1196	US628	1191		
US403	1174	US567SU	1195	US629	1191		
US404	1174	US568SU	1195	US630	1191		
US405	1174	US569SU	1195	US631	1191		
US406	1174	US570	1175	US632	1191		
US407	1174	US571	1175	US633	1191		
US408SU	1196	US572	1175	US634	1191		
US409SU	1196	US573	1175	US635	1191		
US410SU	1197	US574	1175	US636	1191		
US411SU	1197	US575	1175	US637	1191		
US412SU	1197	US576	1175	US638	1191		
US413	1176	US577	1175	US639	1191		
US501SU	1197	US578	1175	US640	1191		
US502SU	1197	US579	1175	US641	1191		
US503SU	1197	US580	1175	US642	1191		
US504SU	1197	US581	1175	US643	1191		
US505SU	1197	US582	1175				
US506SU	1197	US583	1175	XG006R	84		
US507SU	1197	US584	1175				
US508SU	1197	US585	1175				
US509SU	1197	US586	1175				
US523SU	1197	US587	1175				
US524SU	1197	US588	1175				
US525SU	1197	US589	1175				
US526	1175	US600	1174				
US527	1175	US601	1174				
US528	1175	US602	1174				
US529	1175	US603	1174				
US530	1174	US604	1174				
US531	1174	US605	1174				
US532	1191	US606	1174				
US533	1191	US607	1174				
US534	1177	US608	1174				
US536	1178	US609	1174				
US541	1176	US610	1174				
US542	1176	US611	1174				
US543	1176	US612	1174				
US544	1176	US613	1174				
US545	1176	US614	1174				
US546	1176	US615	1174				
US547	1176	US616	1174				

Numerical Index

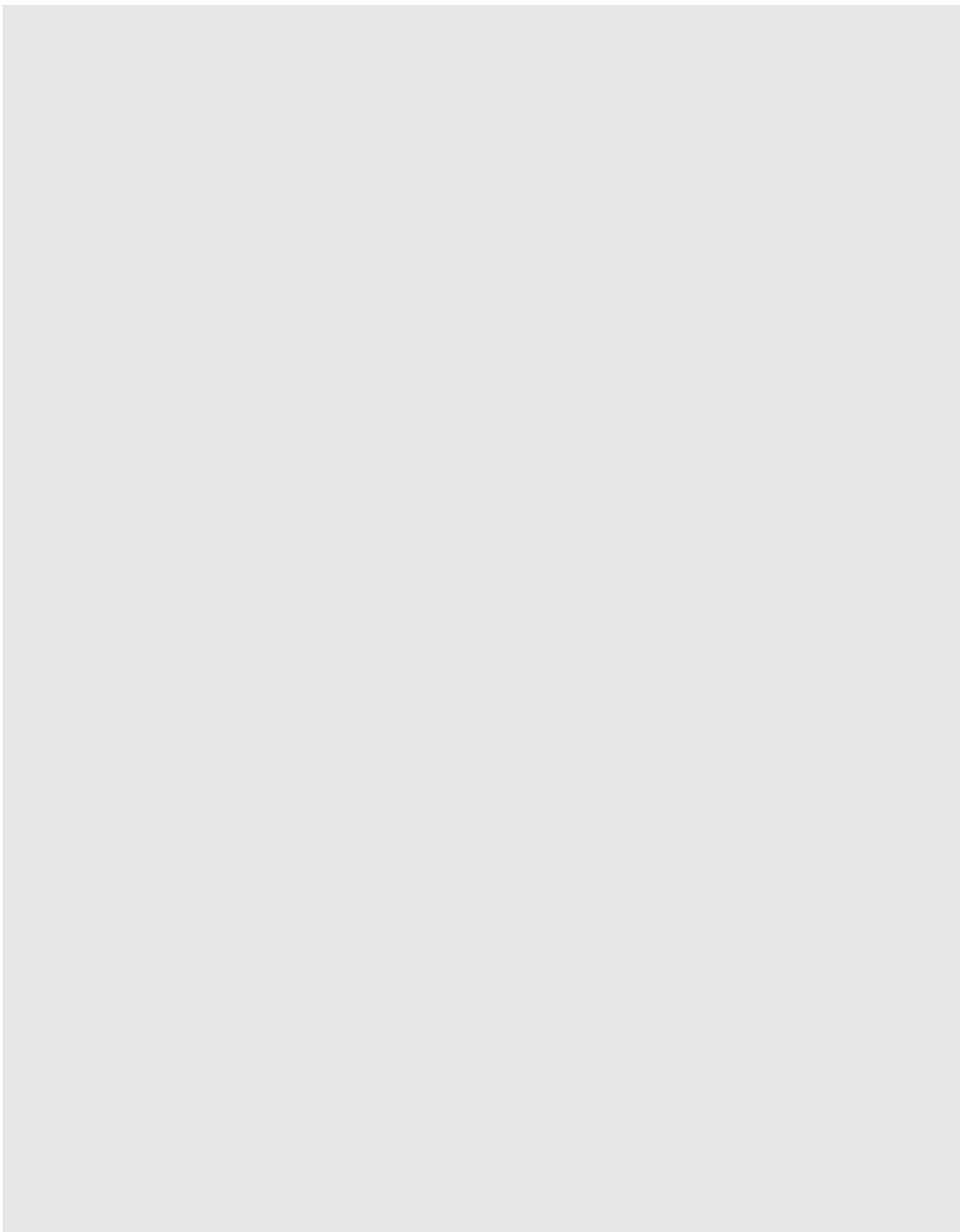



Alphabetical Index

Alphabetical Index

A

PAGE	PAGE	PAGE
A	ALLIS	Aortic
AACHEN Brain Spatulas.....1164	DUROGRIP TC Intestinal Grasping Forceps... 114	Aneurysm Clamps, Atraumatic.....439-444
Abdominal	Tissue Holding Forceps..... 107, 108, 110	Arch Dilator 496
Forceps 106-133, 137-139, 290	ALLIS-ADAIR Tissue Holding Forceps 109	Atraumatic 414, 439, 445-451, 455, 456
Retractors.....215-241, 243-254, 1262	ALLIS-COAKLEY Tonsil Clamp 717	Valve Retractors..... 508
Scissors.....21	ALLISON Sweetheart Lung Spatula 516, 517	Appendectomy
ABEL Uterine Tenaculum Forceps1221	ALLPORT	Forceps 125
ABRAHAM Tonsil Knife 738	Mastoid Searcher..... 568	Retractors..... 240
ACLAND Micro Vessel Clips 808	Retractor..... 793	Applicators
ADAIR Uterine Tenaculum Forceps1216	ALM Retractors 274, 793	Cotton..... 568
Adenoid	AL-MEFTY	ScalpFix.....1068
Curettes.....740-742	Chisel1105	Applying & Removing Forceps, RANEY1069
Forceps 712	Dissectors1104	Approximators 810
Adenotomes 726	Ligature Needle1105	Micro..... 809, 810
Spare Blades..... 726	Spoons.....1104	Nerve..... 810
ADSON	Suction Cannula.....1105	Arachnoid Blades 301
Baby Retractor..... 277	ALPHONSO Speculum 846	Areola Markers 795
Bayonet Forceps..... 619	Aluminum Hand 794	Arteriotomy Scissors 329, 339, 340
Bipolar Forceps, Disposable.....1195	Amalgam Carrier 745	Artery
Bone Rongeur1027	Amputation	Forceps152, 154, 156, 161,
Burrs.....1071	Knives..... 308162, 168, 396, 782
Delicate Dressing Forceps90	Saws..... 309	Forceps, COLLER..... 393
Delicate Tissue Forceps..... 90, 92	Anastomosis	Scissors..... 340
Delicate Tonsil Forceps..... 170, 714	Clamps..... 124, 126, 463	ASCH Uterine Secretion Scoop1288
DUROGRIP TC Tissue Forceps..... 102	Clamps, Atraumatic 474, 476	ASH Septum Forceps 648
Forceps, Bipolar1186	Forceps & Clamps 124	Aspirating Tubes 739
Hemostatic Forceps..... 165	ANDERSON-ADSON Retractor 942	ATKINSON Retrobulbar Needle 873
Needle Holders55	ANDERSON-NEIVERT Osteotomes 680	Atraumatic
Nerve Hooks1122	ANDREWS Pynchon Suction Tube 739, 798	Anastomosis Clamps..... 474, 476
Periosteal Elevators.....960	Aneurysm Neck Dissectors, Jannetta Style	Aorta Clamps..... 470, 472
Retractors..... 942, 943, 9451112	Aortic Aneurysm Clamps.....440-444
Suction Cannula.....312, 1152	ANIS-WAND Nucleus Manipulator 853	Aortic Clamps..... 414, 439, 445-451, 455, 456
ADSON-BROWN Tissue Forceps91	Anoscopes 287, 289	Bronchus Clamps 417
AESCULAP	Anterior Resection Clamps 137, 1258	Bulldog Clamps..... 487, 488
DUROGRIP TC Needle Holders..... 888	ANTHONY Suction Tubes 576	Carotid & Subclavian Clamps 464
Rectal Swab Holder..... 150	Antrum	Coarctation Clamps..... 427, 428, 460
AESCULAP-PRATT Uterine Tenaculum Forceps	Cannula..... 691	Compression Clamps..... 1257
.....1222	Cannula, Irrigating 615, 691	Forceps404-407, 415, 416
Air Injection Cannula 875	Curettes..... 695, 696	Hysterectomy Forceps 1252, 1254
AKAHOSHI Combo Prechopper 876	Elevators 662	Iliac Clamps 438
Alabama University Forceps 843	Needles..... 615	Intestinal Forceps..... 134-137, 140, 141
ALEXANDER	Punch Forceps..... 623, 628	Kidney Clamps 1303
Bone Rongeur699, 1024	Punches..... 635-637, 1137	Lobe Forceps..... 1310
Gouges..... 800	Rasps..... 674	Mini-Bulldog Clamps.....483-487
Periosteal Elevator..... 502	Retractors..... 656	Multi-Purpose Clamps 409, 418,
ALFONSO Nucleus Trisector 861	Aorta 419, 473, 477
ALLEN Intestinal Forceps 117	Clamps, Atraumatic 420, 470, 472	Neonatal Clamps..... 411
Alligator Forceps 541-549, 621, 711, 1249	Punches..... 504	Ovum Forceps..... 1229
	Vascular Clamps..... 421	Parametrium Clamps..... 1255
		Patent Ductus Clamps..... 464, 465

	PAGE
Atraumatic	
Pediatric Anastomosis Clamps.....	463, 467, 468
Pediatric Multi-Purpose Clamps.....	468
Pediatric Vascular Clamps	409, 410, 412, 459, 461
Peripheral Clamps.....	413, 435-437, 459
Profunda Clamps.....	431
Renal Artery Clamps	469
Ring Handle Bulldog Clamps	408, 458
Suction Tubes.....	315, 1147, 1149
Suture Forceps	414
Tangential Clamps.....	453, 454
Tissue Holding Forceps.....	113
Titanium Forceps.....	379
Titanium Pediatric Vascular Clamps.....	389
Titanium Vascular Clamps	381-389
Ultra Light Forceps	98
Ureter Forceps.....	1306
Vascular Clamps.....	420, 422-425, 429, 432, 461, 462
Vascular Tissue Forceps	98-100, 371
Vena Cava Clamps	452
Atrial Retractors	511, 512
Atrium Retractors	509, 510
AUFRANC Cobra Retractors	923, 924
AUFRICHT	
Bone Rasps.....	674
Nasal Retractor.....	652
Auricle Clamps	402
AUSTIN	
Dissecting Knife.....	569
Duckbill Elevator	582
Excavator.....	583
Micro Suture Forceps	774
Pick.....	558
AUVARD Vaginal Specula	1275, 1276
Awls	803, 996
Suture Wire.....	803
B	
BABCOCK	
Atraumatic Tissue Holding Forceps	113
DUROGRIP TC Tissue Holding Forceps	114
Thoracic Tissue Forceps.....	394
Tissue Holding Forceps.....	111-113
Baby ADSON Dissecting Forceps.....	174
Baby CRILE Hemostatic Forceps.....	166
Baby CRILE-WOOD DUROGRIP TC	
Needle Holders.....	62

	PAGE
Baby KOCHER Intestinal Forceps.....	120
Baby METZENBAUM	
Dissecting Scissors	18
DUROTIP TC Dissecting Scissors.....	35, 344
DUROTIP TC Wavecut Dissecting Scissors	
.....	37, 346, 762
Noir Dissecting Scissors.....	613, 765
SuperCut Scissors	47
Baby MIXTER, Dissecting Forceps	182
Baby Mosquito (HARTMANN) Hemostatic	
Forceps.....	162
Baby SATINSKY Vena Cava Clamp	400
Baby SENN-MILLER Retractors	194
Backflush Infusion Cannula	874
BACKHAUS Towel Clamp	186, 187
BACKHAUS-KOCHER Towel Clamp.....	187
BAILEY Rib Contractors	525
BAINBRIDGE Intestinal Forceps.....	117
BAKES Bile Duct Dilators.....	292
BALFOUR	
Abdominal Retractors.....	247-252
Baby Abdominal Retractor	246
Ball Dissectors, Micro	1109
BALLENGER	
Chisels.....	678
Septum Gouge	678
Sponge Forceps.....	146
Swivel Knives.....	687
Bandage Scissors	7-10, 880-883, 885
BANE-HARTMANN Bone Rongeur.....	699, 1025
Bar, Traction.....	916
BARNES Suction Tubes	576
BARNES-NEVILLE Obstetrical Forceps	1236
BARNHILL Adenoid Curettes	740
BARON Suction Tubes.....	576
BARR Fistula Probes.....	298
BARRAQUER	
Cilia Forceps	833
Cyclodialysis Spatula	855
Eye Speculum.....	845
Iris Scissors.....	826
Micro Needle Holders.....	358, 829
BARRÉ	
Instruments for Radical Prostatectomy	
.....	1179, 1299-1302
Suture Holding Frame	1302
BARRETT	
Placenta Forceps	1240
Uterine Tenaculum Forceps.....	1217
BARRON Scalpel Handle.....	302

	PAGE
BARTH Bone Curette.....	696
BAUMGARTNER	
DUROGRIP TC Needle Holders.....	61
DUROGRIP TC Wire Twisters	73
Needle Holders	54
Bayonet	
Chisels.....	679
Curettes.....	1011
Forceps	86-88, 105, 618-620
BECHERT Nucleus Rotator.....	853
BECHERT-MCPHERSON Forceps.....	842
BECK Rongeur.....	1039
BECKER Septum Scissors.....	603
BECKMANN	
Adenoid Curettes	740
Nasal Speculum.....	672
Pediatric Nasal Speculum	672
Retractors.....	945, 946
BECKMANN-ADSON Retractors	944
BEEBE Crown Scissors.....	807
BELLUCCI	
Alligator Forceps.....	543
Micro Ear Scissors.....	536
Picks	558
Suction Tubes.....	579
Bending Instruments.....	897
BENGOLEA Hemostatic Forceps.....	171
BENETT	
Bone Levers.....	939
Bone Retractors.....	939
BENSON Pylorus Spreader.....	125
BERGER Biopsy Forceps	1248
BERGMANN	
Hook.....	193
Mallets.....	990, 991
Plaster Scissors	884
BERKE Ptosis Forceps	840
BERKE-JAEGER Lid Plate	850
BERLIN Endometrial Biopsy Curette.....	1288
BERNHARD Towel Clamp.....	186
BERRY DUROGRIP TC Wire Twisters.....	74
BETHUNE Rib Shears.....	502
BEYER Bone Rongeurs.....	699, 1025, 1028
BIEMER	
Micro Approximators	809
Nerve Approximators	810
Vein Scissors.....	353
Vessel Clips	809
BIEMER-MUELLER Approximators	810
BIERER Ovum Forceps.....	1240

Alphabetical Index

B

PAGE	PAGE	PAGE
Bile Duct Dilators..... 292	BLAKESLEY-WILDE Nasal Forceps..... 643	BOYS-ALLIS Tissue Holding Forceps..... 107
BILL Traction Handle..... 1236	BLOUNT Knee Retractor..... 917	BOZEMANN
BILLEAU Ear Loops..... 585	BLUMENTHAL Bone Rongeurs..... 700, 1023	Uterine Dressing Forceps..... 1215
Biopsy	BOEHLER	Uterine Scissors..... 1206
Alligator Forceps..... 1249	Bone Cutting Forceps..... 1062	BOZEMANN-DOUGLAS Uterine Dressing
Endocervical Curettes..... 1288	Bone Rongeurs..... 700, 1028	Forceps..... 1216
Endometrial Curettes..... 1288	BOETTCHER Tonsil scissors..... 706	BRACKEN
Forceps..... 149, 150, 633, 1246-1250	BOIES Nasal Fracture Elevator..... 658	Iris Forceps..... 842
Forceps & Clamps..... 150	Bolt Cutters..... 894	Irrigating Cannula..... 871
Rectal Forceps..... 149	BONACCOLTO Utility Forceps..... 837	BRACKMANN Suction Tubes..... 577
Trepine, Bone..... 997	Bone	Brain Spatulas..... 1163-1165
BipoJet Bipolar Dissecting Scissors..... 1168	Biopsy Trephines..... 997	BRAND Tendon Holding Forceps..... 778
Bipolar	Clamps..... 915, 916	BRAUN
Cords and Adapters..... 1198-1200	Crusher..... 649	Uterine Depressor..... 1287
Cords and Adapters, Disposable..... 1199	Curettes..... 588, 696-698,	Uterine Tenaculum Forceps..... 1218
Dissecting Scissors..... 1168998-1001, 1003-1007	BRAUN-STADLER Episiotomy Scissors..... 1211
Forceps..... 1190	Cutting Forceps..... 639, 1060-1063	BRAUNSTEIN Fixed Caliper..... 876
Forceps, Irrigating..... 1191, 1192, 1194	Drills..... 995, 996	Breakers, Plaster..... 886
Forceps, Irrigating, Disposable..... 1197	Elevators..... 926-939, 960, 968, 973	BREISKY Vaginal Specula..... 1274
Forceps, Irrigating, Rose Gold..... 1191, 1193	Files..... 675, 677, 957-959	BREWSTER Retractor..... 507
Forceps, Non-Irrigating..... 1169-1173,	Holding Forceps..... 904, 906-914	BRIDGE Hemostatic Forceps..... 171
.....1177-1182, 1184-1187, 1190	Hooks..... 207, 940, 941	BRINKERHOFF Rectal Specula..... 289
Forceps, Non-Irrigating, Ceramic Insulated	Levers..... 926-939, 970-972	BRISTOW Bone Lever..... 971
.....1188	Micro Curettes..... 586	BRODIE Director..... 294
Forceps, Non-Irrigating, Disposable... 1195-1197	Pneumatic Punches..... 1058, 1059	BROM Vein Hook..... 193
Forceps, Non-Irrigating, Rose Gold	Punches..... 629, 630, 1050-1057	Bronchus
.....1174-1176, 1183, 1187	Raspatories..... 959, 965	Clamps, Atraumatic..... 417
Forceps, Non-Irrigating, Titanium..... 1184	Rasps..... 674-677, 805, 957-959	Forceps..... 397, 398, 400
Forceps, Non-Irrigating, Transnasal... 1188, 1189	Reposition Forceps..... 906	Forceps, COOLEY..... 397
Forceps, Specialty Disposable..... 1197	Retractors..... 926-939	BROPHY
BIRCHER Cartilage Forceps..... 900	Rongeurs..... 629, 631, 632,	Delicate Dressing Forceps..... 94
BIRCHER-GANSKE Cartilage Forceps... 901, 902699-703, 1021-1034	Gum Scissors..... 707
BIRKETT Hemostatic Forceps..... 169	Rongeurs, Duckbill..... 1031, 1032	BROWN
BISHOP Mastoid Gouge..... 581	Tampers..... 694	Needle Holder..... 617
BISHOP-HARMON	Tamps..... 993	Tissue Forceps..... 91
Anterior Chamber Irrigator..... 870	BONN	BROWN-BAHNSON Bayonet Forceps..... 87, 619
Iris Forceps..... 834	Eye Forceps..... 773, 836	BROWN-CUSHING Bayonet Forceps..... 86
Blade Ejector..... 244	Micro Iris Hook..... 859	BRUENINGS Septum Forceps..... 623
Blades	Suture Forceps..... 839	BRUNS
Adenotome..... 726	Tissue Forceps..... 839	Bone Curettes..... 999, 1003
Arachnoid..... 301	BONNEY Tissue Forceps..... 83	Plaster Scissors..... 883
Chisels..... 975	Bookwalter-Style Universal Ring Retractor	Spinal Curettes..... 1002
Osteotomes..... 975	System ..257, 258, 260, 262-266, 268, 270, 271	BUCK
Scalpel..... 302, 306	BORES	Ear Curettes..... 585
Tongue..... 736, 737	Axis Marker..... 863	Ear Forceps..... 541
Blair Retractor..... 652	Optical Zone Marker..... 864	BUCK-GRAMCKO Bone Retractor..... 927
BLAKE	BOSE Tracheal Hooks..... 720	BUIE Fistula Probes..... 296
Gall Stone Forceps..... 129, 130	BOUCHERON Ear Speculum..... 562, 563	Bulldog Clamps
Uterine Curette..... 1293	Bowls, Metal..... 325	Atraumatic..... 483, 487, 488
BLAKESLEY Thru-Cut Forceps..... 642	BOWMAN Lacrimal Probes..... 865	Micro..... 485

	PAGE
Bulldog Clamps	
Mini, Atraumatic.....	482-487
Ring Handle, Atraumatic.....	408, 458
Bulldog Scissors	596
BUMM Uterine Curettes	1291, 1294
BUNGE Evisceration Spoon	850
BUNNELL	
Dissecting Probe.....	1019
Tendon Passing Probes.....	777
BURATTO Cannula	871
Burrs	1071
BUSHE Bone Curettes	1001
Button End Knives	687, 688
C	
C.W. MAYO Tissue Forceps	85
Cables, Bipolar	1198-1200
Caesarean Hemostatic Forceps	1239
CAIRNS Dura Retractor	1118
Calipers	1064, 1065
Ear.....	584
Eye.....	876
TESSIER Type.....	1064
TOWNLEY Femur.....	1065
CALLISON-ADSON Tissue Forceps	91, 618
CAMELLIN Style LASIK Alcohol Well	851
CAMPBELL Miniature Scissors	1320
Canal Knives	571
Cannulas	
Eye.....	869-875
Irrigation.....	497, 578, 691, 692
Suction.....	311-314, 316-318, 320, 322, 576-579, 689-691, 739, 798, 1145, 1146, 1151, 1152
Uterine.....	1295
Ventricular Puncture.....	1152
Capsulotomy Scissors	827
Cardiac Valve Forceps	372
Cardiovascular	
Forceps.....	84
Scissors.....	335-337
CARMALT Artery Forceps	161, 396
Carotid & Subclavian Clamps, Atraumatic ...	464
Carotid Artery Bypass Shunt Clamps	481
CARREL Hemostatic Forceps	782
Carriers, Cotton	568
CARROLL Tendon Pulling Forceps	779
CARTER Sphere Introducer	877
CARTER-GLASSMAN Resection Clamp	138

	PAGE
Cartilage	
Crusher.....	649
Forceps.....	900-902
Scissors.....	604, 758, 885
CASPAR	
Bone Curettes.....	1004-1006
Calipers.....	1064
Elevators.....	1153
Exploration Hooks.....	1120
Micro Dissectors.....	1115, 1116
Micro Knife.....	1125
Micro Scissors.....	1142
Nerve Root Retractors.....	1156
Retractors.....	218
Rongeurs.....	1037, 1038, 1045, 1046
Scalpel Handle.....	301
Suture Pusher.....	1123
CASPAR Style Bipolar Forceps	1180, 1181
CASTANEDA Atraumatic Neonatal Clamps	411
CASTROVIEJO	
Capsule Forceps.....	836
Corneal Scissors.....	823, 824
Corneal Suture Forceps.....	773, 835, 836
Cyclodialysis Spatula.....	855
Delicate Suture Forceps.....	835
Delicate Tissue Forceps.....	834
DUROGRIP TC Micro Needle Holders...	360, 769
Eye Caliper.....	876
Fixation Forceps.....	834
Lacrimal Dilator.....	866
Micro Needle Holders.....	357, 830
Micro Scissors.....	823
Spatulas.....	855
CATALANO Lacrimal Intubation Set	867
Catheter Introducing Forceps	147, 712
Catheter Wire Guide	1319
Catheters	1319, 1322
CATLIN Amputating Knife	308
Caval Occlusion Clamps	466
Ceramic Insulated Bipolar Forceps	1188
Cerebellar Retractors	278
Cerebellum Retractors	947
Cervical Biopsy Punch Forceps	1248
Cervical Curettes	1008, 1009
CHADWICK Delicate Scissors	27
CHAMPIONNIÈRE Bone Drill	996
CHANDLER Bone Elevators	973
CHANG	
Nucleus Hydrodissector.....	873

	PAGE
CHANG	
Phaco Chopper.....	852
CHANG-SEIBEL Phaco Chopper	852
CHARNLEY Initial Incision Retractor	956
CHARRIERE Amputation Saw	309
CHAUX Sternal Retractor	532
Cheek Retractors	215
CHELSEA-EATON Anal Speculum	288
CHERRY	
Clamp.....	434
Osteotomes.....	680
Chest Tube Passer	390
Children's Hospital Retractor	198
Chisels	580, 678, 679, 799, 974-976, 980
Bayonet.....	679, 1129
Blades.....	975
Fishtail.....	801
Osteophyte.....	1118
Skull Base.....	1105
Sternum.....	503
Choppers	837, 852
CHURCH Scissors	329
CINELLI	
Lower Lateral Scissors.....	596
Osteotomes.....	680, 681
Circumcision Clamps	1313
Clamps	433, 434, 457
Anastomosis.....	124
Anastomosis, Atraumatic.....	463, 467, 468, 474, 476
Anterior Resection.....	137, 1258
Aorta.....	420, 470, 472, 480
Aortic.....	414, 439, 445-451, 455, 456
Aortic Aneurysm.....	440-444
Atraumatic.....	381-389, 478
Auricle.....	402, 475
Bone.....	915, 916
Bronchus.....	417
Bulldog.....	482-488
Bulldog Ring Handle.....	408, 458
Carotid & Subclavian.....	464
Carotid Artery Bypass Shunt.....	481
Caval Occlusion.....	466
Circumcision.....	1313
Coarctation.....	402, 427, 428, 430, 460
Columella.....	622
Compression.....	1257
Dorsal Venous Complex.....	1300
Fixation.....	1311
Fogarty-type.....	399

Alphabetical Index

C

PAGE	PAGE	PAGE
Clamps		
Hysterectomy.....	1252, 1253	
Iliac.....	438	
Intestinal.....	123, 125, 290	
Intestinal, Anastomosis.....	124, 126	
Kidney.....	1303-1306	
Liver.....	478, 479	
Meatus.....	1313	
Mosquito.....	164	
Multi-Purpose.....	409, 418, 419, 468, 473, 477	
Neonatal.....	411	
Parametrium.....	1255, 1256	
Pediatric.....	389, 409, 410, 412,459, 461, 463, 467, 468	
Penis.....	1312	
Peripheral.....	413, 435-437, 459	
Profunda.....	431	
Renal Artery.....	469	
Right Angle.....	172, 173, 180-182, 184, 185	
Serrefine.....	840	
Tangential.....	453, 454, 471	
Titanium.....	381-389	
Tongue.....	147, 148, 718, 719	
Tonsil.....	160, 161, 169, 170, 713-717	
Towel.....	186-189	
Tubing.....	189, 390, 391	
Uterine.....	1258-1260	
Vascular.....	381-389, 404-429, 431-481, 483	
Vasectomy.....	1311, 1312	
Vena Cava.....	400, 401, 452	
Vessel, Alpha.....	489, 490	
Vessel, Micro.....	488	
CLAYMAN Lens Holding Forceps	838	
CLAYMAN-JAFFE Lens Hook	856	
Clip Applying Forceps	808, 809	
Clips, Vessel	808, 809	
CLOWARD Lamina Spreaders	950	
CLOWARD Style		
Cervical Retractors.....	925	
Rongeurs.....	1049	
COAKLEY		
Sinus Curettes.....	696	
Trocar.....	615	
Coarctation Clamps	402, 427, 428, 430, 460	
COBB		
Bone Curettes.....	1007	
Bone Impactor.....	994	
Gouge.....	981	
Osteotomes.....	984	
Periosteal Elevators.....	964-966	
COBB		
Raspatories.....	965	
Cobra Retractors	923, 924	
COHEN Micro Needle Holders	830	
COLIBRI Forceps	841	
COLIBRI Style Corneal Forceps	841	
COLLER		
Artery Forceps.....	393	
Hemostatic Forceps.....	168	
Needle Holders.....	54	
COLLIER-ANDERSON Dissecting Forceps	185	
COLLIN		
Abdominal Retractors.....	244	
Retractor.....	197	
Sponge Forceps.....	147, 718	
Tissue Holding Forceps.....	115	
Tongue Clamp.....	147, 718	
Uterine Curette.....	1293	
Uterine Elevating Forceps.....	1231	
Vaginal Specula.....	1263	
Columella Clamps	622	
COLVER Tonsil Seizing Clamp	717	
Compression Clamps	1257	
Conductors	1073	
Conjunctival, Scissors	818	
CONVERSE		
Button End Knife.....	687	
Chisels.....	678	
Double Hook Retractor.....	651	
DUROGRIP TC Needle Holders.....	61	
Nasal Retractor.....	653	
Needle Holders.....	53	
Osteotomes.....	681, 985	
Skin Hooks.....	651	
Cookie Cutter, Areola	795	
COOLEY		
Aortic Aneurysm Clamp.....	439	
Arteriotomy Scissors.....	339	
Atraumatic Anastomosis Clamps.....	476	
Atraumatic Aorta Clamps.....	470, 472	
Atraumatic Bulldog Clamps.....	487	
Atraumatic Carotid Et Subclavian Clamps.....	464	
Atraumatic Coarctation Clamps.....	460	
Atraumatic Multi-Purpose Clamps.....	473	
Atraumatic Patent Ductus Clamps.....	464, 465	
Atraumatic Pediatric Anastomosis Clamps.....	463, 467, 468	
Atraumatic Pediatric Multi-Purpose Clamps.....	468	
Atraumatic Pediatric Vascular Clamps.....	409, 410	
COOLEY		
Atraumatic Peripheral Clamps.....	459	
Atraumatic Renal Artery Clamp.....	469	
Atraumatic Ring Handle Bulldog Clamps.....	458	
Atraumatic Vascular Clamps.....	461, 462	
Atraumatic Vascular Tissue Forceps.....	100	
Atrial Retractors.....	511, 512	
Atrium Retractors.....	509, 510	
Auricular Appendage Clamp.....	475	
Bronchus Forceps.....	397	
Cardiovascular Scissors.....	335	
Caval Occlusion Clamps.....	466	
Neonatal Scissors.....	340	
Sternotomy Retractors.....	528-530	
Suction Tubes.....	312, 313	
Tangential Clamp.....	471	
Vascular Tissue Forceps.....	100	
COOLEY-BECK Atraumatic Pediatric Clamps	459	
COOLEY-SATINSKY Atraumatic Pediatric Clamps	461	
COOPER Suture Scissors	6	
Corneal Dissector Knife	877	
Coronary		
Artery Scissors.....	338	
Tissue Forceps.....	101	
CORWIN Scalpel Handles	301	
CORYLLOS Retractors	514	
COTTLE		
Biting Forceps.....	638	
Bulldog Scissors.....	596	
Chisels.....	678	
Columella Clamps.....	622	
Fishtail Chisel.....	801	
Hooks.....	192, 784	
Mallet.....	693, 990	
Nasal Retractors.....	654	
Nasal Speculum.....	666, 667	
Osteotomes.....	681, 682	
Periosteal Elevators.....	660, 662	
Rasp.....	674	
Retractors.....	655, 790	
Septum Knife.....	687	
Septum Scissors.....	602	
Septum Specula.....	665	
COTTLE-JOSEPH Skin Hooks	785	
COTTLE-KNAPP Plastic Scissors	596	
COTTLE-MASING Plastic Scissors	596, 750	
COTTLE-WALSHAM Septum Forceps	648	
Cotton Applicators	568	

	PAGE
CRABTREE "JIMMY" Dissectors.....	580
CRAFOORD	
Auricle Clamp.....	402
Hemostatic Forceps.....	392
CRAFOORD-SELLORS Coarctation Clamp	402
CRANE Mallet	693
CRAWFORD	
Lacrimal Intubation Set.....	868
Retrieving Hook.....	868
CREGO Periosteal Elevators	971
CRILE	
Hemostatic Forceps.....	167
Hook Et Dissector	203
Retractors.....	197, 788
Vessel Hook.....	506, 1121
CRILE-MURRAY Needle Holders	55
CRILE-WOOD	
DUROGRIP TC Needle Holders.....	63, 771, 772
Needle Holders	55
Crimpers	551, 552
Crown Scissors	807
Crusher	
Bone	649
Cartilage	649
Crypt Hooks	291, 299
CULBERTSON Canal Knife	571
Cups, Metal	325
Currettes	
Adenoid.....	740-742
Antrum	695, 696
Bayonet.....	1011
Bone	588, 696-698, 998-1001, 1003-1007
Bone, Micro.....	586
Cervical.....	1008, 1009
Ear.....	585-589
Endocervical Biopsy.....	1288
Endometrial Biopsy	1288
Ethmoid.....	589
Eye	877
Lumbar	1010
Micro.....	1087, 1109
Pituitary	1129, 1131-1134, 1137, 1138, 1140, 1141
Ring	589
Rotatable Ring.....	1137
Sinus.....	695, 696
Spinal.....	1000, 1002, 1008-1010
Spinal, Black Handle.....	1012, 1013
Uterine.....	1289-1294
CURTIS Tissue Forceps	83

	PAGE
CUSCO Vaginal Specula	1263
CUSHING	
Bayonet Forceps.....	86
Bipolar Forceps.....	1174, 1177, 1191
Bipolar Forceps, Disposable.....	1196
Decompression Retractor.....	1155
Delicate Tissue Forceps.....	94
Drills	1071
Dura Hook	1121
DUROGRIP TC Tissue Forceps.....	104
Elevators	658
Forceps, Bipolar	1186
Periosteal Elevators.....	1153
Rongeurs.....	1040
Tissue Forceps	94
Vein Retractors.....	204, 205
Vessel Hooks.....	506, 1121
CUSHING-CAIRNS	
Ventricular Cannula.....	1152
Ventricular Puncture Cannulas	1152
CUSHING-KOCHER Retractor	204
CUSHING-LANDOLT Transsphenoidal Specula	673, 1127
Cutters	
Bolt.....	894
IOL.....	818
Nail	886
Pin.....	893
Wire.....	552, 806, 887-891, 893
CZERNY	
Rectal Speculum	285
Uterine Tenaculum Forceps.....	1222
D	
DALE Atraumatic Vascular Clamps	432
DANDY	
Hemostatic Forceps.....	782
Nerve Hooks	506, 1122
DARTIGUES Uterine Elevating Forceps	1230
DAUBENSPECK Bone Currettes	1000
DAUTREY Osteotomes	683
DAVIDSON Scapula Retractors	515
DAVIS	
Brain Spatulas.....	1165
Mouth Gags.....	731-732
Rhytidectomy Scissors	597
Vascular Spatula	1117
DAVIS-BOYLE Mouth Gags	733
DAVIS-MEYER Mouth Gags	734

	PAGE
DAY Ear Hook	554
DEAN Tonsil Scissors	706
DEAVER	
Retractors.....	228-233
Suture Scissors.....	2
DEBAKEY	
Arteriotomy Scissors.....	329
Atraumatic Aortic Aneurysm Clamps	440-442, 444
Atraumatic Aortic Clamps	455
Atraumatic Coarctation Clamps	427, 428
Atraumatic Dissecting Forceps.....	415
Atraumatic Forceps.....	404, 415
Atraumatic Iliac Clamps	438
Atraumatic Mini-Bulldog Clamps	485, 486
Atraumatic Multi-Purpose Clamps	409, 418, 419
Atraumatic Patent Ductus Forceps.....	426
Atraumatic Peripheral Clamps	435-437
Atraumatic Ring Handle Bulldog Clamps.....	408
Atraumatic Suture Forceps.....	414
Atraumatic Tangential Clamps.....	453
Atraumatic Ultra Light Forceps.....	98
Atraumatic Vascular Tissue Forceps	98-100, 371
DUROGRIP TC Needle Forceps.....	103
DUROGRIP TC Needle Holders.....	65, 367, 368
DUROTIP TC Vascular Scissors	343
Femur Retractors	282
Micro Scissors.....	356, 1077
Mosquito Atraumatic Forceps	404
Offset Scissors.....	339
Partial Occlusion Clamp	457
Suction Cannulas.....	314
Titanium Atraumatic Forceps	379
Titanium Atraumatic Pediatric Vascular Clamps.....	389
Titanium Atraumatic Vascular Clamps	381, 382, 384-387
Vascular Clamps.....	457
Vascular Dilators.....	494
Vessel Scissors	339
DEBAKEY-BAINBRIDGE Atraumatic Forceps	405
DEBAKEY-BECK Atraumatic Vena Cava Clamps	452
DEBAKEY-COLLIER Dissecting Forceps	185
DEBAKEY-HARKEN Atraumatic Vascular Clamps	406
DEBAKEY-HESS Bulldog Clamps	483

Alphabetical Index

D

PAGE	PAGE	PAGE
DEBAKEY-LAMBERT Atraumatic Aortic Clamp 448	DERLACKI	Dissecting
DEBAKEY-MORRIS Atraumatic Aortic Cross-Clamp 450	Dissecting Knives..... 569	DUROTIP TC Scissors..... 30-40, 344-347, 762, 1207, 1209
DEBAKEY-PEAN Atraumatic Forceps 407	Ossicle Holding Forceps..... 539	Forceps..... 172-185, 379, 380, 392, 415
DEBAKEY-RUMEL Atraumatic Forceps 416	Dermal Punches 797	Micro..... 1074, 1075
DEBAKEY-SATINSKY	DERRA Atraumatic Pediatric Forceps 412	Probes..... 1019
Atraumatic Tangential Clamps..... 454	DERRA-COOLEY Atraumatic Clamps 461	Scissors..... 11-20, 26, 28, 49-52, 329-332, 335, 349-352, 606, 613, 706, 753-755, 759, 765, 766, 1074, 1075
Titanium Atraumatic Vascular Clamps..... 388	D'ERRICO	Scissors, Pituitary..... 1143
DEBAKEY-SEMB Atraumatic Aortic Aneurysm Clamp 443	Hypophyseal Forceps..... 1141	Suction Tubes..... 322
DEBAKEY-SUBRAMANIAN Atraumatic Aortic Clamp 456	Nerve Root Retractor..... 1156	Titanium Forceps..... 379, 380
DECKER Rongeurs 1047	DESCHAMPS Needles 77	Dissectors 203, 659, 1019
Decompression Retractors 1155	DESJARDINS	Facial Nerve..... 580
DELEE	Gall Duct Forceps..... 127	Flap Knife..... 572
Obstetrical Forceps..... 1235	Gall Duct Probes..... 299	Intima..... 1019
Universal Retractor..... 1262	Gall Stone Scoops..... 299	Jannetta Style..... 1110
Delicate	DESMARRES Lid Retractors 790, 849	"JIMMY"..... 580
Dressing Forceps..... 80, 89, 90, 93-95, 371	DEVGAN Titanium Capsulorhexis Forceps ... 838	Micro..... 1086, 1107-1109, 1112, 1113, 1115, 1116, 1119
DUROTIP TC Par Scissors..... 760	DEWECKER Iris Scissors 827	Micro, Ball..... 1109
DUROTIP TC Scissors..... 33-38, 344-347, 611, 707, 760, 762, 819	Dia Dust	MILLIGAN..... 1116
Needle Forceps..... 103	Forceps..... 375	Nerve Sparing..... 1301
Scissors..... 24-27, 328, 329, 331-333, 605-610, 748-755, 812-816	Micro Forceps..... 375-378	PENFIELD..... 1114, 1115
SuperCut Scissors..... 42-48, 763, 764	Micro Needle Holders..... 362-366	Pituitary..... 1131, 1133, 1135, 1141
Suture Forceps..... 835	Micro Ring Forceps..... 375-378	Septum..... 662
Thumb Forceps..... 93	Needle Holders..... 367	Skull Base..... 1104
Tissue Forceps..... 89-94, 96-98, 371, 773, 774, 832, 834	Rasps..... 675	Submucous..... 662
Tonsil Forceps..... 169, 170, 714	Diamond Knives 1126	Suction..... 692, 798, 1150
DEMARTEL	DIEFFENBACH Bulldog Clamps 482	Tonsil..... 725
Conductor..... 1073	DIETER Malleus Nipper 550	Varix..... 492
DUROTIP TC Vascular Scissors..... 343	DIETRICH	YASARGIL..... 1114
Scalp Flap Forceps..... 1070	Atraumatic Aortic Clamp..... 414	DITTEL Urethral Sounds 1320
DEMARTEL-WOLFSON Anastomosis Clamps 124	Coronary Artery Scissors..... 338, 342	DIXON Center Blades 251
DENHARDT Mouth Gag 730	Micro Bulldog Clamps..... 485	DOANE Z Knee Retractors 918
DENIS-BROWNE Abdominal Retractors 253	SuperCut Scissors..... 342	DOCKHORN Cheek Retractors 215
Dental, Amalgam Carrier 745	Vessel Scissors..... 338	DOCKTOR Tissue Forceps 97
Depressors	DIETRICH-HEGEMANN Vessel Scissors 338	Dorsal Scissors 600, 601
Tongue..... 722	DIETRICH-POTTS Micro Scissors 341	DUROTIP TC..... 611
Uterine..... 1287	Dilator Forceps 101	Dorsal Venous Complex Clamps 1300
DERF	Bile Duct..... 292	DORSEY Dural Separator 1124
DUROGRIP TC Needle Holders..... 59	Lacrimal..... 866	DOYEN
Needle Holders..... 53	Tracheal..... 721	Abdominal Retractors..... 236
DERLACKI	Uterine..... 1283-1286	Director..... 293
Capsule Knives..... 569	Vascular..... 494-496	Intestinal Forceps..... 118, 119, 136
Chisel..... 580	DINGMANN	Myoma Screws..... 1233
	Bone Holding Forceps..... 904	Needle Holders..... 54
	Mouth Gag..... 729	Ovum Forceps..... 1229
	Wire Passing Needle..... 709	Periosteal Elevators..... 501
	Directors 293, 294	Vaginal Specula..... 1273, 1274, 1277
	Disc Rongeurs 1047	
	Disectomy Forceps 1049	
	Displacer, Septum 658	
	Disposable Bipolar Forceps 1195-1197	

	PAGE
DOYEN-COLLIN Mouth Gag	729
DOYEN-JANSEN Mouth Gag	730
DRAFFIN Chest Support	737
Dressing Forceps	79, 86, 88-90, 93-95, 141-148, 371, 539, 540, 618-622, 718, 719, 1213, 1214
Delicate	80, 93, 371
Drills	1071
Bone	995, 996
Hand	995
DRYSDALE Nucleus Manipulator	853
DUCKER Retractors	948
DUPLAY Uterine Tenaculum Forceps	1220
Dura	
Hooks	1117, 1118, 1121
Retractors	1118
Scissors	329
Dural Separators	1124
DUROGRIP TC	
Bone Rasps	958
Forceps, ADSON Tissue	102
Forceps, ALLIS Intestinal Grasping	114
Forceps, BABCOCK Tissue Holding	114
Forceps, CUSHING Tissue	104
Forceps, DEBAKEY Needle	103
Forceps, GERALD Needle	103
Forceps, GORNEY-ADSON Tissue	102
Forceps, GRUENWALD Bayonet	105
Forceps, SEMKEN Tissue	104
Forceps, Thumb	103, 374
Forceps, Tissue	105
Forceps, WANGENSTEEN Tissue	105
Forceps, Wire Holding	892
Needle Holders, AESCULAP	888
Needle Holders, Baby CRILE-WOOD	62
Needle Holders, BAUMGARTNER	61
Needle Holders, CASTROVIEJO	360, 769
Needle Holders, CONVERSE	61
Needle Holders, COOLEY	370
Needle Holders, CRILE-WOOD	63, 771, 772
Needle Holders, DEBAKEY	65, 367, 368
Needle Holders, DERF	59
Needle Holders, Fine	64
Needle Holders, FINOCHIETTO	72
Needle Holders, FRENCH EYE	67
Needle Holders, GIANNINI	361
Needle Holders, GILLIES	771
Needle Holders, HALSEY	60
Needle Holders, HEANEY	71, 1212
Needle Holders, HEGAR	69

	PAGE
DUROGRIP TC	
Needle Holders, HEGAR-OLSEN	770
Needle Holders, HELLBERG-KUPKA	59
Needle Holders, JACOBSON	361
Needle Holders, LEWIN	770
Needle Holders, MASING	60
Needle Holders, MASSON	70
Needle Holders, MATHIEU	75
Needle Holders, MAYO-HEGAR	68
Needle Holders, MAYO-HEGAR-SEELEY	64
Needle Holders, MAYO-MASSON	70
Needle Holders, Micro	360, 361, 367, 370, 769
Needle Holders, MILLS	361
Needle Holders, MUELLER	71
Needle Holders, NEW ORLEANS	62
Needle Holders, RYDER	66, 369
Needle Holders, SAROT	62
Needle Holders, SPENCER	360
Needle Holders, STRATTE	72, 370
Needle Holders, WANGENSTEEN	69
Needle Holders, WEBSTER	61
Needle Holders, Wire Twisters	73, 74
DUROTIP TC	
Par Scissors, Delicate	760
Scissors, Baby METZENBAUM Dissecting	35, 344
Scissors, Baby METZENBAUM Wavecut	37, 346, 762
Scissors, DEBAKEY Vascular	343
Scissors, Delicate	33-38, 344-347, 611, 707, 760, 762, 819
Scissors, DEMARTEL Vascular	343
Scissors, Dissecting	30-40, 344-347, 762, 1207, 1209
Scissors, Dorsal	611
Scissors, Facelift	761
Scissors, FOMON Dorsal	611
Scissors, GOLDMAN-FOX Tenotomy	612, 760
Scissors, GORNEY-FREEMAN	761
Scissors, Iris	611, 760, 819
Scissors, LEXER Dissecting	36
Scissors, MAYO Dissecting	31, 32, 345, 1207
Scissors, MAYO Wavecut Dissecting	37
Scissors, MAYO-LEXER Dissecting	30
Scissors, MAYO-LEXER Wavecut Dissecting	40
Scissors, METZENBAUM Dissecting	33, 34, 344, 345
Scissors, METZENBAUM Wavecut Dissecting	38, 346, 347, 762, 1209
Scissors, NELSON-METZENBAUM Dissecting	35

	PAGE
DUROTIP TC	
Scissors, NELSON-METZENBAUM Wavecut	39, 347
Scissors, Operating	29
Scissors, SIMS Uterine	1207
Scissors, SIMS Wavecut Uterine	1209
Scissors, Strabismus	612, 819
Scissors, Suture	29
Scissors, Tenotomy	612, 760
Scissors, TOENNIS-ADSON Dissecting	36
Scissors, TOENNIS-ADSON Wavecut	39, 346
Scissors, Uterine	1207, 1208
Scissors, Vascular	343
Scissors, Wavecut Dissecting	37-40, 346, 347, 762, 1209
Scissors, Wavecut Iris	611, 761, 820
Scissors, Wavecut Ligature	41, 348
Scissors, Wavecut Strabismus	820
Scissors, Wavecut Uterine	1209
Scissors, WERTHEIM Uterine	1207
Scissors, Wire	30, 343, 807
Wire Cutters	891
DUVAL Lung Forceps	394
DUVAL-COLLIN Tissue Holding Forceps	116
E	
Ear	
Curettes	585-589
Flap Knives	572
Forceps	539-541, 543-548, 550
Hooks	554, 555, 589
Loops	585
Micro Elevators	582
Micro Forceps	542, 543, 549
Micro Hooks	192, 555
Micro Knives	569-575
Micro Needles	537, 538, 709
Micro Scissors	536
Picks	558-561
Snare	553
Specula	562-567
Wire Forceps	552
EASTMAN Vaginal Retractors	1272
EC/IC Bypass Instruments	
Noir Bypass Vessel Punch	1103
Noir Forceps	1102
Noir Needle Holders	1103
Noir Scissors	1101

Alphabetical Index

E - F

PAGE	PAGE	PAGE
EC/IC Bypass Instruments		
Storage Tray.....	1103	
ECHLIN Bone Rongeurs.....	1031	
EICKEN Irrigating Antrum Cannulas.....	691	
Ejector, Blade.....	244	
Elevators.....	235, 658, 659,	
.....	661-664, 804, 1117, 1153	
Antrum.....	662	
Ball End.....	660	
Black Handled.....	968	
Bone.....	926-939, 960, 968, 973	
Ear Micro.....	582	
Jannetta Style.....	1110	
Metatarsal.....	961	
Micro.....	1107	
Nasal.....	664	
Nasal Fracture.....	658-660	
Periosteal.....	498, 500-502, 659, 660, 662-664,	
.....	676, 805, 960, 962-967, 969-971, 1153	
Rib.....	499	
Septum.....	662	
ELLIOTT Obstetrical Forceps.....	1235	
EMMET Fistula Hook.....	193	
Enderectomy		
Spatulas.....	494	
Strippers.....	493	
Endocervical Biopsy Curettes.....	1288	
Endometrial Biopsy Curettes.....	1288	
Endospecula.....	1282	
Enucleation Scissors.....	817	
Enucleators, Pituitary.....	1130, 1132, 1133, 1139	
Epicardial Retractors.....	272, 508	
Episiotomy Scissors.....	1211	
EPPENDORF Biopsy Forceps.....	1250	
EPSTEIN Spinal Curettes.....	1000	
ESMARCH Plaster Scissors.....	884	
Ethmoid		
Curettes.....	589	
Forceps.....	643	
Ethmoidal Forceps.....	644, 645	
Pediatric.....	636	
EVES Tonsil Snares.....	726	
Excavators.....	582, 583	
"Whirlybird".....	583	
Exploration Hooks.....	1120	
Extractors, Varix.....	492	
Eye		
Calipers.....	876	
Cannulas.....	869-875	
Fixation Rings.....	862	
Eye		
Forceps.....	773, 832, 836, 838-844	
Hooks.....	859-861, 868	
Knives.....	877	
Lacrimal Intubation Set.....	867, 868	
Lens Loops.....	855	
Manipulators.....	850-854, 856-859, 861	
Markers.....	862	
Markers Et Gauges.....	863, 864	
Punches.....	877	
Retractors.....	724, 848-850	
Rotators.....	853	
Scissors.....	817	
Spatulas.....	851, 852, 854, 855, 859	
Specula.....	845-847	
F		
Face Lift Scissors.....	606, 758	
Facial Nerve Dissectors.....	580	
FAHLBUSCH		
Curettes.....	1141	
Spoon.....	1141	
FARABEUF		
Bone Holding Forceps.....	909	
Periosteal Elevators.....	498	
Retractors.....	196	
FARABEUF-COLLIN Periosteal Elevators.....	498	
FARABEUF-LAMBOTTE Bone Holding		
Forceps.....	909	
FARRELL Cotton Applicators.....	568	
FARRIOR		
Ear Speculum.....	563, 564	
Footplate Picks.....	558	
FAVOLORO Artery Scissors.....	340	
FAVALORO-MORSE Sternotomy Retractors.....	525	
FEILCHENFELD Splinter Forceps.....	781	
Femur Retractors.....	282	
FERGUSON		
Bone Holding Forceps.....	908	
Gall Stone Scoops.....	298	
Suction Cannulas Et Tubes.....	317, 318, 1151	
FERGUSON-FRAZIER Suction Tube.....	689	
FERRIS-SMITH		
Fragment Forceps.....	622	
Tissue Forceps.....	89	
Files, Bone.....	675, 677, 957-959	
Finger		
Goniometer.....	323	
Reposition Forceps.....	905	
Finger		
Ring Saws.....	802	
FINOCHIETTO		
Dissecting Forceps.....	179	
DUROGRIP TC Needle Holders.....	72	
Rib Spreaders.....	518-521	
FINOCHIETTO-BURFORD Rib Spreader.....	522	
FINSEN Retractors.....	272, 791	
FISCH Sharp Hook.....	1120	
FISHER Tonsil Knife.....	738	
Fistula		
Clamps.....	428	
Hooks.....	193, 651	
Probes.....	295, 296, 298, 299	
Flap Knife Dissectors.....	572, 575	
Flat Nosed Pliers.....	898	
FLETCHER Sponge Forceps.....	1227	
FLETCHER-VAN DOREN Uterine Polyp		
Forceps.....	1226	
FLIERINGA Scleral Fixation Ring.....	862	
FLYNN Scleral Depressor.....	850	
FOERSTER Sponge Forceps.....	144	
FOERSTER-BALLENGER Sponge Forceps.....	145	
Fogarty-type		
Clamps.....	399	
Spring Clip Applicator Forceps.....	399	
FOMON		
Bone File.....	675, 958	
Dorsal Scissors.....	601	
DUROGRIP TC Bone Rasps.....	958	
DUROTIP TC Dorsal Scissors.....	611	
Lower Lateral Scissors.....	601, 757	
Osteotomes.....	684	
Retractor.....	655	
Saber-Back Scissors.....	601	
SuperCut Scissors.....	614, 764	
Footplate		
Knives.....	569	
Picks.....	558, 559	
Foraminotomy Kerrisons.....	1057	
Forceps		
Abdominal.....	106-133, 138, 139, 290	
Abdominal, Anastomosis.....	124, 126	
Adenoid.....	637, 712	
Alligator.....	541-549, 621, 711, 1249	
Appendectomy.....	125	
Artery... ..	152, 154, 156, 161, 162, 168, 396, 782	
Atraumatic.....	379, 404-407, 415, 416	
Bayonet.....	86-88, 105, 618-620	
Biopsy.....	149, 150, 633, 1246-1250	

	PAGE
Forceps	
Bipolar.....	1169-1194
Bipolar, Ceramic.....	1188
Bipolar, Disposable.....	1195-1197
Bone Cutting.....	639, 1060-1063
Bone Holding.....	904, 906-914
Bone Reposition.....	906
Bronchus.....	397, 398, 400
Caesarean Hemostatic.....	1239
Cardiac Valve.....	372
Cardiovascular.....	84
Cartilage.....	900-902
Catheter Introducing.....	147, 712
Clip Applying.....	808, 809
Coronary Tissue.....	101
Cup.....	546, 547, 1048
Delicate Suture.....	835
Delicate Tissue.....	834
Dia Dust.....	375-378
Dilator.....	101
Disectomy.....	1049
Dissecting.....	172-185, 379, 380, 392, 415
Dressing.....	79, 80, 86, 88-90, 93-95,141-148, 371, 539, 540,618-622, 718, 719, 1213, 1214
DUROGRIP TC Bayonet.....	105
DUROGRIP TC Needle.....	103
DUROGRIP TC Thumb.....	103
DUROGRIP TC Tissue.....	102, 104, 105
DUROGRIP TC Tissue Holding.....	114
DUROGRIP TC Wire Holding.....	892
Ear.....	539-541, 543-548, 550
Ear Wire.....	552
Endometrial Polyp.....	1227
Ethmoidal.....	636, 643-645
Eye.....	773, 832, 836, 838-844
Finger Reposition.....	905
Fogarty-type Spring Clip Applicator.....	399
Foreign Body.....	541, 1311
Gall Duct.....	127-129
Gall Stone.....	129, 130
Genitourinary.....	1310
Grasping.....	380, 711, 1046, 1047
Hemorrhoidal.....	290
Hemostatic.....	151-171, 392, 396, 713-715, 782
Hypophyseal.....	1141
Hysterectomy.....	1251-1256
Intestinal.....	117-122, 126-141
Intestinal Grasping.....	106-116
Iris.....	833-844

	PAGE
Forceps	
Jewelers.....	96, 773, 774, 832
Kidney Stone.....	131-133, 1307-1309
Laryngeal.....	709
Laryngeal Micro.....	710
Ligature.....	178, 489, 1123
Lobe.....	1310
Lung.....	372, 394
Mammary Tissue.....	101
Membrane Puncturing.....	1232
Micro.....	373-378, 776, 833, 834, 836,1078-1080, 1093, 1094, 1098, 1099, 1102
Micro Cup.....	549
Micro Ear.....	542, 543, 549
Micro Ring.....	374-378
Micro Suture.....	373, 773-776, 833, 835, 836
Micro Tissue.....	1084
Monopolar.....	79
Mosquito.....	162-164, 404
Muscle.....	837, 843
Nail Extracting.....	802
Nasal.....	621, 622, 624-628,631, 633, 638, 640-647
Nasal Suction.....	634
Obstetrical.....	1234-1238
Ostrum Antrum Punch.....	636
Ovum.....	1229, 1240-1245
Patella.....	912
Patent Ductus.....	426, 464, 465
Pituitary.....	1141
Pituitary Micro.....	1136, 1143
Placenta.....	1240-1245
Punches.....	623
Reposition.....	903, 905, 906
Right Angle.....	172-185, 392
Scalp Flap.....	1070
SENSATION Micro.....	1093, 1094
Septum.....	623, 624, 648
Septum Morselizer.....	649
Splinter.....	101, 781
Sponge.....	141-148, 715, 718,719, 1213, 1214, 1227
Suture.....	164, 174, 403, 414, 839, 841
Suture Removal.....	91
Tendon Holding.....	778
Tendon Interlacing.....	780
Tendon Pulling.....	779
Tendon Retriever.....	779
Tendon Seizing.....	777, 778
Thoracic Artery.....	393

	PAGE
Forceps	
Thoracic Tissue.....	394
Thoracoscopy.....	395
Thru-Cut.....	642
Thumb.....	93
Tissue.....	79, 81-94, 96-98, 100, 101, 371, 372,379, 380, 618, 619, 775, 836, 838, 839
Tissue Holding.....	106-116, 394
Titanium Micro.....	378
Titanium Standard.....	379, 380
Tonsil.....	632, 716
Tumor.....	1079
Tumor Grasping Micro.....	1079-1081, 1084,1094, 1099, 1143
Tunnelling.....	403
Tying.....	837, 843
Ureter.....	1306
Uterine Dressing.....	1213-1216
Uterine Elevating.....	1230-1232
Uterine Polyp.....	1226, 1228
Uterine Tenaculum.....	1216-1226
Uterine Vulsellum.....	1221, 1224
Utility.....	837
Vascular Tissue.....	98-100, 371
Vasectomy.....	1311, 1312
Wire.....	552
Wire Holding.....	892, 895
XS Micro.....	1098, 1099
Foreign Body Forceps	541, 1311
Forks	
Implant.....	1131
Jannetta Style.....	1111
Tuning.....	591
FRAZIER	
Dura Retractor.....	1118
Dural Separator.....	1124
Suction Cannulas Et Tubes.....	312, 318-320,689-691, 798, 1150, 1151
Suction Dissector Tubes.....	1150
Suction Tube.....	318, 690, 798
FREEMAN Facelift Retractor	789
FREER	
Chisels.....	679
Double Hook.....	190, 785
Elevators.....	661
Mucous Knife.....	688
Septum Gouge.....	679
Septum Knife.....	688
FREER-YASARGIL Elevators	661
FREIMUTH Ear Curettes	587

Alphabetical Index

F - G

	PAGE
FRENCH EYE DUROGRIP TC Needle Holders...	67
FRIEDMANN Micro Bone Rongeurs.....	700, 1021
FRYKHOLM Bone Rongeur	1032
Fukushima Style Suction Tubes...	321, 1144, 1147
G	
Gags, Mouth.....	729-737
Galea Hooks.....	1070
Gall Duct	
Forceps	127-129
Probes	299
Gall Stone	
Forceps	129, 130
Scoops	293, 298, 299
GALLAHER Bone Rasp.....	675
GARRETT Vascular Dilators	495, 496
GASS Retinal Detachment Hook.....	861
GAST Tongue Blades.....	737
Gauges.....	1065
CLOWARD Style.....	1065
GELPI	
Perineal Retractors.....	280, 1261
Vaginal Retractors.....	281, 1261
GEMINI Right Angle Forceps.....	172
Genitourinary Forceps.....	1310
GERALD	
Bayonet Forceps.....	87
Bipolar Forceps.....	1177, 1187, 1192
Delicate Dressing Forceps.....	93, 371
Delicate Tissue Forceps.....	92, 371
Dia Dust Micro Ring Forceps.....	375
DUROGRIP TC Needle Forceps.....	103
Micro Forceps.....	373
Titanium Dissecting Forceps	380
Titanium Tissue Forceps.....	380
GERALD-DEBAKEY, Forceps	92
GERSTER Traction Bar.....	916
GHANDI Sickle Knife	571
GIERTZ-STILLE Rib Shears	503
GIGLI	
Hook Handle.....	310, 1073
Saw Handle.....	310, 1073
Wire Saws	310, 1072
Gill Iris Forceps	844
GILLIES	
Bone and Zygoma Hook	655
Delicate Tissue Forceps.....	97
DUROGRIP TC Needle Holders with Scissors..	771
Needle Holder/Scissors.....	58

	PAGE
GILLIES	
Skin Hooks.....	191, 784
GILLS-WELSH VANNAS Scissors	827
GILSBACH Retractor Et Handrest System	
.....	1160-1162
GIL VERNET	
Retractors.....	205
Vein Retractors.....	1318
Giraffe	
Frontal Sinus Forceps	626
Thru-Cut Sinus Forceps.....	627
GLASSER Dia Dust Micro Needle Holders.....	365
GLASSMAN	
Anterior Resection Clamps	137, 1258
Intestinal Forceps.....	140, 141
Liver Clamps.....	139
GLASSMAN-ALLIS Non-Crushing Common	
Duct Forceps.....	111
GLENNER Vaginal Retractor	1279
GLOVER	
Atraumatic Bulldog Clamps	488
Atraumatic Mini-Bulldog Clamps.....	487
Atraumatic Vascular Clamps.....	429
Coarctation Clamps.....	430
Titanium Atraumatic Vascular Clamps.....	382
GLUCK Rib Shears.....	502
GOELET Retractor.....	195
Goiter Retractors	213, 723
GOLDMAN Septum Scissors	602
GOLDMAN-FOX SuperCut Scissors.....	43, 763
GOLDMANN Septum Displacer	658
GOLDMANN-FOX DUROTIP TC Tenotomy	
Scissors	612, 760
Goniometer.....	323
GOODYEAR Uvula Retractor	723
GORDON Uterine Tenaculum Forceps.....	1222
GORNEY	
Scissors.....	335, 759
Suction Dissector.....	692, 798
SuperCut Scissors	45, 764
Turbinate Scissors.....	603
GORNEY-ADSON DUROGRIP TC	
Tissue Forceps	102
GORNEY-FREEMAN	
DUROTIP TC Scissors.....	761
SuperCut Scissors	759
GOSSET Abdominal Retractors.....	245, 246
Gouges.....	581, 679, 800, 976-979, 981, 983
Lamina.....	976

	PAGE
Gouges	
Mastoid.....	581
Septum	678, 679
Spongiosa.....	977, 978
GOULIAN Skin Graft Knife.....	796
GRAEFE	
Hooks	190, 783
Nerve/Vessel Hooks.....	785
Scissors.....	756
Tissue Forceps.....	836
GRAETHER Collar Button.....	856
Grasping Forceps.....	1046, 1047
Titanium.....	380
GRAVES Vaginal Specula.....	1266
GRAY Gall Duct Forceps.....	128
GREEN Strabismus Hook.....	860
GREEN-ARMYTAGE Caesarean Hemostatic	
Forceps.....	1239
GREENE Retractor.....	214
GREGORY	
Atraumatic Mini-Bulldog Clamps	483, 484
Atraumatic Profunda Clamps	431
GREGORY-DEBAKEY Atraumatic Bulldog	
Clamp	483
GRIFFITHS-BROWN Tissue Forceps.....	838
GROSS Sponge Forceps	141
GRUBER Ear Specula.....	565, 566
GRUENWALD	
Bayonet Forceps.....	86, 619
DUROGRIP TC Bayonet Forceps.....	105
Nasal Forceps.....	624
GRUENWALD-HENKE Nasal Cut Rongeurs ..	625
Guides, Ligature.....	1123
GUILFORD-WRIGHT	
Dissecting Knives	570
Drum Elevator.....	582
Footplate Pick.....	558
Micro Bone Curette.....	586
Stapes Pick.....	558
Wire Cutter	552
GULEKE Bone Rongeur	1026
Gum Scissors.....	707
GUTHRIE Double Hooks.....	190, 783
GUYON	
Atraumatic Kidney Clamps.....	1303
Kidney Clamps	1304
Wire Catheter Guide.....	1319

	PAGE
H	
HAIGHT Rib Spreader	523
HAJEK	
Irrigating Cannula.....	692
Mallet.....	990
HAJEK-BALLENGER	
Septum Dissector.....	662
Septum Elevator.....	662
HAJEK-KOFLER Punches	629, 630
HAKANSSON Bone Rongeur	1022
HALLE Periosteal Elevator	664
HALLMAN Tunnelling Forceps	403
HALSEY	
DUROGRIP TC Needle Holders.....	60
Needle Holders.....	53
HALSTED	
Hemostatic Forceps.....	165
Mosquito Hemostatic Forceps.....	163
Hammer, Percussion	324
HAMPTON Micro Needle Holders	831
Hand Drills	1071
Handles, Scalpel	300-305, 1299
HANK Uterine Dilators	1285, 1286
HARDY	
Bipolar Forceps.....	1174, 1178, 1192
Bipolar Forceps, Disposable.....	1196
Curettes.....	1129, 1132, 1134
Enucleators.....	1130, 1132, 1133
Implant Fork.....	1131
HARDY-FAHLBUSCH Dissectors	1131
HARRINGTON	
Lung Spatulas.....	224-226
Sweetheart Blades.....	224-226, 268
Sweetheart Blades for URRS.....	268
HARRINGTON-MIXTER Dissecting Forceps ..	183
HARRISON Dissecting Knives	570
HARRS-SINSKEY Lens Manipulating Hook ..	856
HARTMANN	
Alligator Forceps.....	621
Cup Forceps.....	547
Ear Forceps.....	539, 543, 547
Ear Specula.....	566, 567
Intestinal Forceps.....	119, 135
Nasal Dressing Forceps.....	621
Nasal Specula.....	670
Pediatric Ear Specula.....	566
Tuning Forks.....	591
HARTMANN-CITELLI Ear Forceps	547
HARTMANN-HALLE Nasal Specula	671

	PAGE
HARTMANN-HERZFELD Cup Forceps	546
HARTMANN-WULLSTEIN Ear Forceps	540
HARVEY	
Wire Cutter.....	889
Wire Scissors.....	23
HARVEY-JACKSON Retractor	944
HASSON "S" Retractors	234
HAYES Bone Retractors	926
Head Extractors	1238
HEANEY	
Hysterectomy Forceps.....	1252-1253
Hysterectomy Forceps, Atraumatic.....	1254
DUROGRIP TC Needle Holders.....	71, 1212
Needle Holders.....	56
Tissue Forceps.....	84
Uterine Curette.....	1293
Vaginal Retractors.....	1273
HEANEY-BALLENTINE Hysterectomy Forceps	1252
HEANEY-REZEK Hysterectomy Forceps	1251
HEATH Mallet	992, 993
HEGAR	
DUROGRIP TC Needle Holders.....	69
Needle Holders.....	56
Uterine Dilators.....	1283-1285
HEGAR-OLSEN	
DUROGRIP TC Needle Holders with Scissors..	770
Needle Holders.....	768
Needle Holders with Scissors.....	58
HEIFETZ	
Brain Spatulas.....	1163
Tumor Grasping Forceps.....	1081
HEIMING Kidney Stone Forceps	131, 1307
HEISS Hemostatic Forceps	170
HEISS Self-Retaining Retractor	274, 791
HELLBERG-KUPKA DUROGRIP TC Needle Holders	59
Hemorrhoidal	
Forceps.....	290
Ligators.....	290
Hemostatic Forceps	151-171, 392, 396, 713-715, 782
HENCKEL Ear Forceps	541
HENDERSON	
Alignment Marker.....	863
Degree Gauge.....	863
Toric IOL Marker.....	863
HENDREN Atraumatic Cardiovascular Clamps	462
HENKE Tonsil Dissector	725

HENLY	
Atraumatic Clamp.....	415
Retractor.....	283
HENNER Elevator	663
HENNIG Plaster Spreader	886
HENROTIN Uterine Vulsellum Forceps	1221
Heparin Needles	497
HERCULES	
Pin Cutter.....	893
Plaster Shears.....	884
HERRICK Kidney Clamps	1306
HERTZLER Abdominal Retractor	243
HERZ Tendon Seizing Forceps	777
HESS Nerve Root Retractors	1154
HEYMANN Nasal Scissors	599
HEYMANN-KNIGHT	
Nasal Scissors.....	599
Septum Forceps.....	623
HEYWOOD-SMITH	
Sponge Forceps.....	148, 719
Tongue Clamp.....	148, 719
Uterine Polyp Forceps.....	1228
HIBBS	
Bone Curettes.....	1003
Chisels.....	974
Gouges.....	981
Osteotomes.....	983
Retractors.....	919
HILL-FERGUSSON Rectal Retractors	286
HIRSCHMANN Rectal Speculum	288
HOEN	
Dural Separator.....	1124
Periosteal Elevators.....	1153
HOESEL Retractors	216
HOFFER Optical Zone Marker	864
HOHENFELLNER Dissecting Scissors	331
HOHMANN	
Bone Retractors.....	927-930, 934-936
Humoral Head Retractor.....	933
HOHMANN-ALDINGER Bone Retractor	933
HOKE Osteotomes	982
Holders	
Rectal Swab.....	150
Specula.....	567
HOLLE Dissecting Forceps	172, 392
HOLZBACH Hysterectomy Forceps	1251
Hooks	202, 203, 651
Bone.....	207, 655, 940, 941
Crypt.....	291
Dura.....	1117, 1118, 1121

Alphabetical Index

H - J

PAGE	PAGE	PAGE
Hooks	HOUSE-BARBARA	Iris
Ear..... 554, 555, 589	Shattering Needle..... 537	SuperCut Scissors 42
Exploration..... 1120	HOUSE-BARON Suction Tubes 577	Irrigating Antrum Cannula 691
Eye..... 859-861, 868	HOUSE-CRABTREE Pick 559	Irrigation Cannulas 497, 578, 691, 692
Fistula..... 193, 651	HOUSE-DIETER Malleus Nipper 550	ISRAEL Retractors 210, 211
Galea..... 1070	HOUSE-PAPARELLA Ear Curettes 588	IVD Rongeurs 1043
Jannetta Style..... 1110, 1111	HOUSE-STRUT Measuring Rod 584	IVES-FANSLER Anoscope 287
Micro..... 507, 1086, 1108, 1113	HOWARTH Periosteal Elevator 663	
Micro Ear..... 192, 555	HUDSON 89	J
Nerve..... 506, 555, 785, 1121, 1122	Burs..... 1071	JACKSON
Pituitary..... 1132, 1135, 1139, 1140	Dressing Forceps..... 89	Lacrimal Intubation Set..... 867
Saddle..... 787	Drill Brace..... 1071	Laryngeal Forceps..... 709
Sharp..... 1120	HULKA-KENNWICK Uterine Elevating	Nasal Bone Scissors..... 600
Skin..... 190-192, 651, 783-785	Forceps..... 1232	Tendon Seizing Forceps..... 777
Tendon..... 191, 203, 783, 787	HUNT Grasping Forceps 1079	Tracheal Retractor..... 720
Tracheal..... 720	HUNTER Splinter Forceps 101	Vaginal Specula..... 1272
Vein..... 193	HURD	Velvet Eye Aspirating Tubes..... 739
Vessel..... 506, 507, 785, 1121	Needles..... 78	JACKSON-BURROWS Retractor 282
HORSLEY Dural Separator 1124	Pillar Retractors..... 725	JACOBS Uterine Vulsellum Forceps 1224
HOUGH	Tonsil Dissectors..... 725	JACOBSON
Drum Scraper..... 582	Hydrodissection Cannula 870	Bone Curettes..... 697
Ear Curettes..... 586	Hysterectomy	DUROGRIP TC Micro Needle Holders..... 361
Excavators..... 583	Clamps..... 1252, 1253	Enderarterectomy Spatula..... 494
Footplate Auger Drill..... 584	Forceps..... 1251-1256	Forceps..... 619
Footplate Picks..... 559		Hemostatic Forceps..... 163, 164
Picks..... 559	I	Micro Needle Holders..... 357
"Whirlybird" Excavators..... 583	Iliac Clamps, Atraumatic 438	Probes..... 507
HOUSE	IMA Heparin Cannulas 497	Vessel Knife..... 1125
Alligator Crimper..... 551	Impactors	JAEGER
Cutting Block..... 593	Bone..... 994	Hook Retractor..... 191, 783
Cutoff Adapter..... 692	Spinal..... 993	Lid Plate..... 849
Dissecting Knives..... 570	Implant Forks 1131	JAFFE
Ear Curettes..... 587, 588	INGE Lamina Spreaders 950, 951	Lens Spatula..... 854
Ear Forceps..... 544, 548	Initial Incision Retractors 956	Stitch Scissors..... 826
Ear Hook..... 554	Intestinal	Wire Lid Retractor..... 846
Ear Micro Elevator..... 582	Forceps Et Clamps..... 117-141, 290	JAFFE-BECHERT Nucleus Rotator 853
Footplate Chisel..... 580	Grasping Forceps..... 106-116	JAFFE-MALTZMAN Lens Manipulating Hook
Gelfoam Press..... 592	Intima Dissectors 1019 859
Incudostapedial Joint Knife..... 570	IOL Cutter 818	JAMESON
Needle..... 537	IOWA	Hooks..... 860
Picks..... 559, 560	Membrane Puncturing Forceps..... 1232	Muscle Forceps..... 843
Retractors..... 557	Trumpet..... 1295	Needle Holders..... 57
Strut Guide..... 552	Iris	SuperCut Scissors..... 44, 333, 753
Suction Adapter..... 579	DUROTIP TC Scissors..... 611, 760, 819	Tenotomy Scissors..... 332, 607, 752
Suction Irrigator..... 578	DUROTIP TC Wavecut Scissors..... 611, 761, 820	JAMESON-METZENBAUM Dissecting
Suction/Irrigation Cannulas..... 578	Forceps..... 833-844	Scissors..... 332
Suction Tubes..... 577	Noir Dissecting Scissors..... 50, 350, 765	JAMESON-WERBER Tenotomy Scissors 815
Tympanoplasty Knife..... 575	Scissors..... 24, 331, 608, 748,	Jannetta Style
HOUSE-BARBARA 749, 812, 813, 826, 827	Aneurysm Neck Dissectors..... 1112
Pick..... 560		

	PAGE
Dissectors.....	1110
Elevators.....	1110
Forks.....	1111
Jannetta Style	
Hooks.....	1110, 1111
Knives.....	1110
Probes.....	1111
JANSEN	
Bayonet Forceps.....	87, 618
Bone Curettes.....	697
Bone Rongeurs.....	701, 1023
Retractors.....	556, 657
JANSEN-MIDDLETON Septum Forceps.....	624
JAVID Carotid Artery Bypass Shunt Clamps..	481
JEFFERSON Delicate Tissue Forceps.....	92
JENKNER Tunnelling Instruments.....	505
JENSEN Capsule Polisher.....	870
Jewelers	
Bipolar Forceps.....	1185
Bipolar Forceps, Disposable.....	1195, 1196
Micro Forceps.....	96, 773, 774, 832
JEWETT Urethral Sound.....	1319
"JIMMY" Dissectors.....	580
JOHNS-HOPKINS Bulldog Clamps.....	482
JOLL (FRIEDMANN) Thyroid/Vaginal	
Retractor.....	279
JONES	
Adenoid Curettes.....	741
Hemostatic Forceps.....	160
Towel Clamp.....	186
JORDAN Canal Knife.....	571
JORGENSEN Uterine Scissors.....	1205
JOSEPH	
Button End Knives.....	688
Delicate Scissors.....	605, 754
Nasal Knives.....	688
Nasal Saws.....	676
Periosteal Elevator.....	676
Raspatories.....	676
Skin Hooks.....	190, 785
SuperCut Scissors.....	44
JUDD-ALLIS Tissue Holding Forceps.....	109
JULIAN Thoracic Artery Forceps.....	393
K	
KAIRison Pneumatic Bone Punch.....	1058, 1059
KALLMORGEN Vaginal Specula.....	1270
KANTROWITZ Right Angle Forceps.....	173
KATZIN Corneal Scissors.....	825

	PAGE
KAYE	
Face Lift Scissors.....	606, 758
SuperCut Scissors.....	45, 764
KAZANJIAN Bone Cutting Forceps.....	1063
KELLY	
Anoscope.....	289
Delicate Scissors.....	27
Hemostatic Forceps.....	166
Retractor Blades for URRS.....	262
Retractors.....	222, 262
Sponge Forceps.....	146
KELLY-DESCEMET'S Membrane Punch.....	877
KELLY-GRAY Uterine Curettes.....	1292
KELMAN Cystotome.....	874
KELMAN-MCPHERSON Forceps.....	842
KERN-LANE Bone Holding Forceps.....	910
KERN-MINI Bone Holding Forceps.....	910
KERRISON	
Bone Punches.....	629, 1050-1056
Bone Punches, Bayonet-Shaped.....	1057
Bone Punches, Foraminotomy Kerrisons.....	1057
Bone Punches, Laminectomy Rongeurs.....	1053
Mastoid Rongeur.....	590
KEVORKIAN-YOUNGE	
Biopsy Forceps.....	1249
Endocervical Biopsy Curette.....	1288
KEY Periosteal Elevators.....	963, 964
KEYES Dermal Punches.....	797
Kidney	
Clamps.....	1303-1306
Stone Forceps.....	131-133, 1307-1309
Trays.....	325
KIEBACK Dissecting Forceps.....	185
KIELLAND Obstetrical Forceps.....	1234
KILLIAN	
Antrum Cannula.....	691
Elevators.....	663
Septum Gouge.....	679
Septum Specula.....	667, 668
Speculum.....	1127
KILNER	
Dissecting Scissors.....	606, 754
Skin Hook.....	191, 784
KIRBY Hook and Muscle Loop.....	859
KIRK Mallet.....	989
KITZMILLER Clamps.....	478
KLAPP Tendon Hook.....	203
KLEINERT-KUTZ	
Bone Rongeur.....	1027
Elevator and Dissector.....	659

	PAGE
Skin Hooks.....	192, 784
Tendon Retriever.....	779
KLEINSASSERI Micro Scissors.....	708
KLEINSCHMIDT Appendectomy Forceps.....	125
KLINTMALM Liver Clamps.....	478
KNAPP Strabismus Scissors, Delicate.....	816
Knee Retractors.....	917-919
Knight Nasal Scissors.....	600
Knives	
Amputation.....	308
Button End.....	687, 688
Canal.....	571
Canl.....	571
Diamond.....	1126
Eye.....	877
Footplate.....	569
Jannetta Style.....	1110
Lancet.....	1125
Micro.....	1087, 1125
Micro Ear.....	572
Micro Ear.....	569-575
Micro Vessel.....	1125
Mucous.....	688
Nasal.....	687, 688
Roller.....	574
Septum.....	687
Sickle.....	571, 572, 574
Skin Graft.....	795-797
Sternum.....	503
Swivel.....	687
Tonsil.....	725, 738
Tumor Tissue.....	1124, 1125
Vessel.....	1125
KNOLLE Capsule Polisher.....	870
KNOWLES Bandage Scissors.....	7
KOCH	
Nucleus Spatula.....	852
Stop and Chop Manipulators.....	851
KOCHER	
Bone Hooks.....	940
Hemostatic Forceps.....	155
Intestinal Forceps.....	120, 121, 134
Retractors.....	209, 217
KOCHER-LANGENBECK Retractors.....	213
KOCHER-OCHSNER Hemostatic Forceps.....	157
KOENIG	
Elevators.....	664
Vein Retractors.....	203
KOERTE Retractors.....	209
KOERTE-WAGNER Retractor.....	211

Alphabetical Index

K - L

PAGE	PAGE	PAGE
KOFLER Sinus Punch..... 630	Self Retaining Retractors..... 943	LELAND-JONES Atraumatic Peripheral
KOGAN Endospecula..... 1282	LANCASTER Eye Speculum..... 847	Clamps..... 413
KOOS Micro Vessel Knives..... 1125	Lancet Knife..... 1125	LEMMON Intima Dissectors..... 1019
KOS Picks..... 561	LANDOLT	LEMOLE-STRONG Atraumatic Clamps..... 420
KRAEMER	Bipolar Cords and Adapters..... 1198	LEMPERT
Grasping Forceps..... 1046	Bipolar Forceps..... 1190	Bone Curettes..... 698, 1000
Retractor..... 218	Blunt Hooks..... 1139	Bone Rongeurs..... 702, 1024
Osteophyte Chisel..... 1118	Curettes..... 1138	Elevators..... 658, 659
KRASKY Retractor..... 513	Dissecting Suction Tube..... 322	Knife Curette..... 574
KRATZ Capsule Scrubber..... 874	Enucleators..... 1139	Malleus Cutter..... 550
KRATZ-BARRAQUER Eye Speculum..... 845	Scalpel Handles..... 301	LERICHE Hemostatic Forceps..... 168
KRAUSE	Spoon..... 1138	LESTER
Ear Snare..... 553	Spreader..... 673, 1127	Fixation Forceps..... 839
Nasal Polyp Snare..... 650	Tumor Grasping Forceps..... 1143	II Titanium IOL Manipulators..... 854
KRAYENBUEHL Nerve Hooks..... 1121	LANDOLT-REULEN	IOL Manipulators..... 854
KRISTELLER Vaginal Specula..... 1267-1269	Curettes..... 1140	Levers
KRONECKER Needles..... 78	Dissector..... 1141	Bone..... 926-939, 970-972
KUGLEN	Dissectors..... 1133, 1135	Obstetric..... 1239
Iris Hook and Lens Manipulators..... 858	Hooks..... 1132, 1135, 1140	LEWIN
Titanium Iris Hook and Lens Manipulators..... 858	Raspatories..... 1140	Bone Clamp..... 916
KURZE Dissecting Scissors..... 1143	LANE	DUROGRIP TC Needle Holders With Scissors
L	Bone Holding Forceps..... 911 770
LA FORCE Adenotomes..... 726	Bone Lever..... 970	LEWIS
LA GRANGE Delicate Scissors..... 27	LANE-TRETHOWAN Bone Lever..... 970	Bone Rasps..... 676, 959
LABORDE Tracheal Dilators..... 721	LANGE Fistula Hook..... 651	Tonsil Snare..... 727
Lacrimal Cannula..... 869	LANGE-HOHMANN Bone Levers..... 931, 932	LEXER
Lacrimal Dilator..... 866	LANGENBECK	Dissecting Scissors..... 15
Lacrimal Probes..... 865	Bone Holding Forceps..... 908	DUROTIP TC Dissecting Scissors..... 36
LAHEY	Metacarpal Saw..... 310	Gouges..... 977
Dissecting Forceps..... 180	Periosteal Elevators..... 963, 970	Noir Dissecting Scissors..... 50, 350
Gall Duct Forceps..... 128	Retractors..... 212	Osteotomes..... 980
Goiter Retractor..... 213, 723	LANGENBECK-MANNERFELT Retractors..... 787	Spongiosa Gouge..... 977
Tissue Holding Forceps..... 106	Laparotomy Ring..... 243	LEXER-MINI
(SWEET) Gall Duct Forceps..... 127	Laryngeal	Gouges..... 976
LAKESIDE Nasal Scissors..... 599	Forceps..... 709	Osteotomes..... 980
LAMBERT-KAY	Micro Forceps..... 710	LEYLA Self Retaining Retractor..... 1157-1159
Atraumatic Aortic Clamps..... 447	Micro Scissors..... 708	Lid Retractors..... 790, 845-847, 849, 850
Titanium Atraumatic Vascular Clamp..... 383	Mirrors..... 744	LIEBERMAN
LAMBOTTE	LASIK Instruments..... 851	Nucleus Manipulator..... 852
Bone Holding Forceps..... 912	LATHBURY-FARRELL Cotton Applicators..... 568	Speculum..... 846
Osteotomes..... 986, 987	LAWRENCE Dissecting Forceps..... 184	Ligator, Hemorrhoidal..... 290
Rib Elevators..... 499	LAZAR Micro Suture Forceps..... 776	Ligature
Lamina	LEADER Vas Isolate Forceps..... 1311	DUROTIP TC Scissors..... 41, 348
Gouges..... 976	LEBSCHKE Sternum Chisel..... 503	Forceps..... 178, 489, 1123
Spreaders..... 950, 951	LEES Atraumatic Bronchus Clamps..... 417	Guides..... 1123
Laminectomy	LEGUEU Retractor..... 1314	Needles..... 77, 78
Retractors..... 952	LEHNER-UTRATA Capsulotomy Forceps..... 840	Needles, Skull Base..... 1105
Rongeurs..... 1053	LEIVERS Vent Tube Introducer Forceps..... 541	Scissors..... 7, 757, 758
	LEKSELL Bone Rongeurs..... 1031	LILLEHEI-POTTS Tenotomy Scissors..... 332
	LEKSELL-STILLE Bone Rongeur..... 1032	LILLIE Dissecting Scissors..... 706

	PAGE
LISTER	
Bandage Scissors	8-10, 880-882
Sponge Forceps.....	141
LISTON	
Amputating Knives.....	308
Bone Cutting Forceps.....	1061
LISTON-KEY-HORSLEY Bone Cutting Forceps	1063
LISTON-STILLE Bone Cutting Forceps	1063
LITTAUER Ligature Scissors	7, 757
LITTLER Dissecting Scissors	755
LITTLEWOOD Uterine Tenaculum Forceps ...	1224
Liver Clamps	478, 479
LLOYD-DAVIES Rectal Scissors	22
LOCKHART-MUMMERY Fistula Probes	295
LOCKWOOD-ALLIS Tissue Holding Forceps ...	109
LOGAN-REILL Self Retaining Retractor	847
Loops, Ear	585
LORNA Towel Clamps	189
LOTHROP	
Tonsil Knife and Dissector.....	725
Uvula Retractor.....	723
LOVE Nerve Root Retractors	1155
LOVE-GRUENWALD Rongeurs	631, 1041, 1042
LOVELACE Lung Forceps	394
LOWER Gall Duct Forceps	127
Lower Lateral Scissors	596, 601, 757
LOWMAN Bone Clamps	915
LOWMAN-GERSTER Bone Clamp	915
LOWMAN-HOGLUND Bone Clamp	915
LOWSLEY Tractors	1314
LUCAE	
Bayonet Forceps.....	86, 618
Ear Hooks.....	555
LUCAS	
Chisels.....	799
Gouges.....	800
Luer Adapter	692
Luer Lock Adapter	497
LUER	
Bone Rongeurs.....	702, 1022
Retractor.....	196
LUER-FRIEDMANN Bone Rongeur	702, 1021
LUER-KOERTE Gall Stone Scoops	293
LUER-STILLE Bone Rongeurs	1034
LUIKART Obstetrical Forceps	1237
LUIKART-KIELLAND Obstetrical Forceps	1237
LUIKART-MCLANE Obstetrical Forceps	1238
LUIKART-SIMPSON Obstetrical Forceps	1237
LUIKART-TUCKER Obstetrical Forceps	1238

	PAGE
Lumbar Curettes	1010
Lung	
Forceps.....	372, 394
Lung	
Retractors.....	516
Spatulas	224-226, 516, 517
M	
MAGAUAN Plate	737
MAGILL Forceps	147, 712
MAIER Sponge Forceps	1213
MALIS Style	
Bipolar Forceps.....	1183, 1193
Bipolar Forceps, Titanium.....	1187
Nerve Hooks	1121
Malleable	
Abdominal Retractors.....	242
Pituitary Curettes.....	1129
Retractor Blades for URRS.....	263, 264
Retractors.....	256, 263, 264, 268
Spatulas	235
Mallets	693, 694, 801, 988-993
Malleus Nipper	550
MALONEY IOL Manipulators	854
MALTZ Bone File & Rasp	677, 959
MALTZ-ANDERSON Nasal Rasp	677
Mammary Tissue Forceps	101
Manipulators	852
Eye	850-854, 856-859, 861
IOL.....	854
Nucleus	853
MANNERFELT	
Double Spatula	788
Gouge	800
Osteotomes.....	801
Periosteal Elevators.....	805
Retractors.....	786, 787
Saddle Hooks.....	787
Tendon Double Hook.....	787
MARBURG Needle Nose Pliers	805
MARKHAM-MEYERDING Retractors	948
MARQUARDT Bone Rongeur	1030
MARTIN	
Cartilage Forceps.....	902
Cartilage Scissors.....	604
Tissue Forceps	83
Uterine Probe	1286
Vaginal Retractor.....	1280
MARTINI Bone Curettes	588

	PAGE
MASING	
DUROGRIP TC Needle Holders.....	60
Osteotomes.....	684
Periosteal Elevator.....	662
Retractors.....	655, 790
MASSON	
DUROGRIP TC Needle Holders.....	70
Needle Holders	57
MASTERSON Uterine Clamps	1258
Mastoid	
Gouges.....	581
Rongeur.....	590
Searcher.....	568
MATHIEU	
DUROGRIP TC Needle Holders.....	75
Foreign Body Forceps	1311
Rectal Speculum	287
Retractor.....	201
MATSON Rib Stripper/Elevator	499
MAYFIELD Bone Rongeur	1028
MAYO	
Dissecting Scissors	11, 12, 13, 14
DUROTIP TC Dissecting Scissors.....	31, 32,
.....	345, 1207
DUROTIP TC Wavecut Dissecting Scissors.....	37
Gall Duct Probe	299
Noir Dissecting Scissors.....	49, 349
Operating Scissors.....	14, 328
Retractor Blades for URRS.....	265
SuperCut Scissors	28, 45, 46
MAYO-ADAMS Self Retaining Retractor	280
MAYO-COLLINS	
Appendectomy Retractor.....	240
Retractor.....	196
MAYO-HARRINGTON Dissecting Scissors	12
MAYO-HEGAR	
DUROGRIP TC Needle Holders.....	68
Needle Holders	56
MAYO-HEGAR-SEELEY DUROGRIP TC Needle Holders	64
MAYO-LEXER	
Dissecting Scissors	15
DUROTIP TC Dissecting Scissors.....	30
DUROTIP TC Wavecut Dissecting Scissors.....	40
Noir Dissecting Scissors.....	49, 349
MAYO-MASSON DUROGRIP TC Needle Holders	70
MAYO-NOBLE Dissecting Scissors	16
MAYO-ROBSON Intestinal Forceps	122, 135
MAYO-RUSSIAN Tissue Forceps	85

Alphabetical Index

M

PAGE	PAGE	PAGE
MAYO-SIMS Dissecting Scissors..... 15	MENDEZ Degree Gauge..... 863	Micro Scissors
MAYO-STILLE Dissecting Scissors..... 16	Meniscotomes..... 899	EC/IC Bypass..... 1101
MCBURNEY Thyroid Retractors..... 214	Metacarpal Saws..... 310	MIN Noir..... 1083
MCCABE	Metal Bowls & Cups..... 325	Micro Tissue Forceps
Facial Nerve Dissector..... 580	Metatarsal Elevators..... 961	EC/IC Bypass..... 1102
MCCABE	METZENBAUM	MIN Noir..... 1084
Flap Knife Dissector..... 572	BipoJet Bipolar Dissecting Scissors..... 1168	Micro
Sickle Knife..... 571	Dissecting Scissors..... 18	Approximators..... 809, 810
MCCCLINTOCK Placenta & Ovum Forceps..... 1245	DUROTIP TC Dissecting Scissors..... 33, 34,	Ball Dissectors..... 1109
MCCCLURE Micro Scissors..... 823 344, 345	Bone Curettes..... 586
MCCCREA Urethral Sounds..... 1321	DUROTIP TC Wavecut Dissecting Scissors..... 38,	Bulldog Clamps..... 485
MCCULLOCH 346, 347, 762, 1209	Capsule Forceps..... 836
Micro Suction Tubes..... 1148	Noir Dissecting Scissors..... 51, 351, 766	Curettes..... 1087
Probes..... 1120	SuperCut Scissors..... 47, 48, 334, 756	Dia Dust Needle Holders..... 362-366
MCCULLOUGH Utility Forceps..... 843	Scissors..... 18	Dissector Sets..... 1106-1109
MCGEE	METZENBAUM-LIPSETT Scissors..... 604, 758	Dissectors..... 1086, 1107-1109, 1112,
Footplate Picks..... 561	MEYER Reposition Forceps..... 903 1113, 1115, 1116, 1119
Oval Window Rasp..... 584	MEYERDING	Dressing Forceps..... 95
Perforating Needles..... 537	Retractors..... 256, 269, 922	DUROGRIP TC Needle Holders..... 360, 361,
Wire Forceps..... 552	Self Retaining Retractors..... 947 367, 370, 769
MCGIVNEY Hemorrhoidal Forceps..... 290	Thumb Retractors..... 204	Ear Elevators..... 582
MCGLAMRY Metatarsal Elevators..... 961	MEYERHOEFFER Chalazion Curette..... 877	Ear Forceps..... 542, 543, 549
MCHENRY Tonsil Artery & Sponge Holding	MIASPAS Mini-Alif LANGENBECK	Ear Hooks..... 192, 555
Forceps..... 715	Retractors..... 219	Ear Knives..... 569-575
MCHUGH Flap Knife..... 572	Micro Curettes..... 1109	Ear Needles..... 537, 538, 709
MCINDOE	Micro Elevators..... 1107	Ear Scissors..... 536
Bone Cutting Forceps..... 1062	Micro Grasping Forceps..... 1084	Forceps..... 373-378, 776, 833, 834, 836,
Delicate Thumb Forceps..... 93	Micro Instruments 1078-1080, 1093, 1094, 1098, 1099, 1102
Delicate Tissue Forceps..... 93	MIN Noir, EC/IC Bypass Set..... 1102	Hooks..... 1086, 1108, 1113
Skin Hook..... 191	MIN Noir, Micro Curettes..... 1087	Knives..... 1087, 1125
MCINTYRE Anterior Chamber Cannula..... 872	MIN Noir, Micro Dissectors..... 1086	Laryngeal Forceps..... 710
MCINTYRE-BINKHORST Cannula..... 873	MIN Noir, Micro Hooks..... 1086	Laryngeal Scissors..... 708
MCIVOR	MIN Noir, Micro Needle Holders..... 1084	MIN Noir Suction Cannulas..... 1145
Mouth Gags..... 735	MIN Noir, Micro Probes..... 1086	Needle Holders..... 357-359, 367, 829-831,
Mouth Gags, Blades..... 735	MIN Noir, Micro Raspatories..... 1087 1082, 1084, 1095, 1103
MCKENTY	MIN Noir, Micro Scissors..... 1083	Pituitary Forceps..... 1136, 1143
Periosteal Elevator..... 659	MIN Noir, Micro Scoops..... 1086	Pituitary Rongeurs..... 1048
Sphenoid Punch Forceps..... 628	MIN Noir, Micro Tissue Forceps..... 1084	Pituitary Scissors..... 1136, 1142
MCKENZIE Burrs..... 1071	MIN Noir, Micro Tumor Forceps..... 1084	Probes..... 1086
MCPHERSON	MIN Noir, Micro Tumor Knives..... 1087	Raspatories..... 1087, 1112, 1113, 1119
Corneal Suturing Forceps..... 841	MIN Noir, Modular Handles..... 1085	Ring Forceps..... 374-378
Forceps..... 842	MIN Noir, Suction Cannulas..... 1145	Scalpel Blades..... 302
Iris Spatula..... 859	MIN Noir, Trays, Storage..... 1087	Scissors..... 341, 353-356, 708, 767, 768,
Micro Needle Holders..... 831	Noir, EC/IC Bypass Set..... 1101-1103 821-823, 825, 828, 1074-1077,
MEAD	Micro Iris Scissors..... 825 1083, 1088-1092, 1096-1099, 1101
Bone Rongeur..... 703, 1025	Micro Needle Holders	Scoops..... 1086, 1113
Mallet..... 988	EC/IC Bypass..... 1103	SENSATION Forceps..... 1093, 1094
Meatus Clamps..... 1313	MIN Noir..... 1084	SENSATION Needle Holders..... 1095
MEEKER Dissecting Forceps..... 177	Micro Profile Instruments..... 1014	SENSATION Scissors..... 1088-1092
MELTZER Adenoid Punch Forceps..... 632		Spatulas..... 492

PAGE	
Suction Cannulas.....	1146
Suction Tubes.....	1148
Suction Tubes, Atraumatic.....	1147
Suture Forceps.....	373, 773-776, 833, 835, 836
Tissue Forceps.....	96, 773-775, 832, 1084
Titanium Forceps.....	378
Micro	
Titanium Needle Holders.....	366
Trays.....	1087
Tumor Grasping Forceps.....	1079-1081, 1084, 1094, 1099, 1143
Vessel Clamps.....	488-490
Vessel Knives.....	1125
Vessel Scissors.....	353, 356, 768, 1076
Wire Cutting Scissors.....	1076
XS Forceps.....	1098, 1099
XS Scissors.....	1096-1099
MICRO-ADSON	
Delicate Dressing Forceps.....	89
Delicate Tissue Forceps.....	91
Suture Forceps.....	174
Titanium Dissecting Forceps.....	379
Titanium Tissue Forceps.....	379
MICRO-ADSON-BIEMER Tissue Forceps.....	775
Microdissectomy Instruments	
Cervical.....	1015-1017
Lumbar.....	1017
Storage Case.....	1016-1018
MICRO-HALSTED Hemostatic Forceps.....	162
MIDDELDORPF Retractors.....	214
Middle Ear Mirror.....	584
MIDDLETON Adenoid Curettes.....	741
MILLARD Double Hook W/ Thimble Mount.....	651
MILLER Bone Rasps.....	805
MILLES Micro Scissors.....	353, 828
MILLIGAN Dissectors.....	1116
MILLIN	
Atraumatic Lobe Forceps.....	1310
Bladder Retractors.....	1318
MILLS	
Cardiovascular Scissors.....	337
DUROGRIP TC Vascular Micro Needle Holders	361
Mammary/Coronary Tissue Forceps.....	101
Mini-Bulldog Clamps, Atraumatic.....	483-487
Mirrors	
Laryngeal.....	744
Middle Ear.....	584
MISKIMON	
Cerebellar Retractor.....	278

PAGE	
Cerebellum Retractor.....	947
MIXTER	
Dissecting Forceps.....	181, 182
Gall Duct Forceps.....	129
Right Angle Forceps.....	174, 180, 182
MIXTER-O'SHAUGNESSY Dissecting Forceps	179
MOLLISON Retractor.....	279
MOLT	
Elevator.....	804
Mouth Gag.....	729
Raspatory.....	804
Monopolar Forceps.....	79
MORRIS Atraumatic Aortic Cross Clamp.....	449
MORRISON Aspirating Cannula.....	873
MORSE	
Dissecting Scissors.....	331
Sternotomy Retractors.....	526
Mosquito Forceps.....	162-164, 404
Mouth Gags.....	729-737
Protective Covers.....	729
MOYNIHAN Hemostatic Forceps.....	160
Mucous Knives.....	688
MUELLER	
Atraumatic Vessel Clamps.....	489, 490
Dura Hooks.....	1117, 1118
DUROGRIP TC Needle Holders.....	71
Ligature Forceps.....	489
Micro Forceps.....	373, 374, 776
Micro Needle Holders.....	359
Micro Ring Forceps.....	374
Micro Scissors.....	767
Rectal Scissors.....	23
Retractor.....	240
Multi-Purpose Clamps, Atraumatic.....	409, 418, 419, 473, 477
MURLESS Head Extractor.....	1238
MURPHY	
Ball Hook.....	1121
Bladder Retractor.....	1314
Retractors.....	211
MURPHY-LANE Bone Skid.....	939
MUSEUX	
Tonsil Forceps.....	716
Uterine Tenaculum Forceps.....	1224-1226
MUSTARDE Suture Removal Forceps.....	91
Myoma Screws.....	1233
Myringotomy Knives.....	572

N

NABATOFF Vein Strippers.....	491
NAEGELE Obstetrical Forceps.....	1234
NAGAHARA Nucelus Spatula.....	852
NAGEL Micro Scissors.....	356, 1077
Nail	
Cutters.....	886
Extracting Forceps.....	802
Scissors.....	887
Splitting Scissors.....	887
Nasal	
Dressing Forceps.....	621, 622
Elevators.....	664
Forceps.....	621, 622, 624-628, 631, 633, 638, 640-647
Fracture Elevator.....	658
Knives.....	687, 688
Probes.....	686
Rasps.....	584, 674, 675, 677, 958, 959
Retractors.....	652-656
Rongeurs.....	625
Saws.....	676
Scissors.....	596-604
Snare.....	650
Specula.....	666, 667, 669-672
Needle Forceps.....	103
DUROGRIP TC Forceps.....	103
Needle Holders.....	617
ADSON.....	55
AESCULAP.....	888
Baby CRILE-WOOD.....	62
BARRAQUER.....	358, 829
BAUMGARTNER.....	54, 61, 73
BERRY.....	74
BROWN.....	617
CASTROVIEJO.....	357, 360, 769, 830
COHEN.....	830
COLLIER.....	54
CONVERSE.....	53, 61
COOLEY.....	370
CRILE-MURRAY.....	55
CRILE-WOOD.....	55, 63, 771, 772
DEBAKEY.....	65, 367, 368
DERF.....	53, 59
Dia Dust.....	367
Dia Dust Micro.....	362-366
DOYEN.....	54
DUROGRIP TC.....	59-75, 360, 361, 367-370, 770-772, 888, 1212

Alphabetical Index

N - P

PAGE	PAGE	PAGE
DUROGRIP TC Micro360, 361, 367, 370, 769	Shattering..... 537	O
FINOCHIETTO.....72	Tonsil..... 709	Obstetric Lever 1239
FRENCH EYE67	NEGUS	Obstetrical
General Operating 53-57, 1212	Adenoid Curettes 741	Extractors 1238
GIANNINI..... 361	Tonsil Forceps..... 160, 715	Forceps 1234-1238
GILLIES.....58	NELATON Director 294	Forceps, C-Section..... 1236
Needle Holders	NELSON Lung Forceps 372	OBWEGESER
GLASSER 365	NELSON-METZENBAUM	Awl..... 803
HALSEY..... 53, 60	Dissecting Scissors 19, 20	Osteotomes..... 684
HAMPTON 831	DUROTIP TC Dissecting Scissors.....35	Suture Wire Awls..... 803
HEANEY.....56, 71, 1212	DUROTIP TC Wavecut Dissecting Scissors	OBWEGESER-FREER Elevator 664
HEGAR 56, 6939, 347	OCHSNER
HELLBERG-KUPKA59	Noir Dissecting Scissors.....52, 352	Atraumatic Aortic Clamp 451
JACOBSON 357, 361	Neonatal	Trocar..... 322, 616
JAMESON57	Clamps, Atraumatic 411	OCHSNER-DIXON Hemostatic Forceps 162
LEWIN 770	Scissors..... 340	Offset Scissors 339
MASING60	Nerve	OLDBERG Rongeurs1038
MASSON..... 57, 70	Approximators 810	OLIVECRONA
MATHIEU75	Dissecting Scissors 753	Bone Rongeur 1026
MAYO-HEGAR..... 56, 68	Hooks.....506, 555, 785, 1121, 1122	Brain Spatulas.....1164
MAYO-HEGAR-SEELEY.....64	Root Retractors1154-1156	Wire Saws 1072
MCPHERSON..... 831	Sparing Dissectors1301	OMBREDANNE Mallet 992
Micro..... 357-359, 367, 829-831,	Scissors.....1300	Operating
.....1082, 1084, 1095, 1103	Neurosurgical, Skull Base Instruments	DUROTIP TC Scissors.....29
MUELLER..... 71, 359 1104, 1105	Scissors.....14, 328
NEW ORLEANS62	NEW JERSEY Retractor1162	O'SULLIVAN-O'CONNOR Retractor1262
REILL..... 358	NEW ORLEANS	OSCHER-ELSCHNIG Forceps 836
RUBIO74	DUROGRIP TC Needle Holders62	OSHER "Y"-Hook Lens Manipulators 859
RYDER.....66, 367, 369	Lens Loop..... 855	OSHER-NEUMANN Corneal Marker 862
SAROT.....62	NEW'S Suture Scissors 14	Osteophyte Chisels 1118
SENSATION Micro.....1095	NICHAMIN Hydrodissection Cannula 874	Osteotomes680-685, 801, 975, 980, 982-987
SOFFERMAN 617	NICOLA	Blades 975
SPENCER..... 360	Curettes..... 1129, 1131, 1133	OSTRUM Punch Forceps 623
STRATTE..... 72, 370	Micro Scissors.....1142	OTIS Bougies a Boule1322
Titanium Dia Dust..... 367	Raspatories1130	Otologic Scissors 536
Titanium Micro 366	NISSEN Delicate Tonsil Forceps 169, 714	OVERHOLT Dissecting Forceps 176
TROUTMAN 830	Noir Supreme Cut Scissors 49-52, 349-352,	OVERHOLT-GEISSENDOERFER Dissecting
WANGENSTEEN 57, 69 613, 765, 766	Forceps..... 175
WEBSTER 53, 61	NOON AV Fistula Clamp 428	OVERSTREET Endometrial Polyp Forceps 1227
With Scissors.....58	NORFOLK-NORWICH Retractor 942	Ovum
YASARGIL1082	NORTHBENT Ligature Scissors 7, 758	Forceps 1229, 1240-1245
Needle Nose Pliers 805, 887	NOTO Uterine Polyp Forceps1228	Scoops 1294
Needles	NOVAK Endometrial Biopsy Curette 1288	P
Antrum 615	NOYES	PAPARELLA
Cases.....76	Ear Forceps..... 545	Canal Knives..... 571
Ear Micro 537, 538, 709	Micro Scissors..... 823	Duckbill Elevator 582
Heparin..... 497	NUGENT Utility Forceps 840	Ear Hook, Spoon..... 589
Ligature 77, 78	Nurse's Bandage Scissors10	
Passing 709		
Septum..... 615		

	PAGE
Fenestrometer.....	584
Needles.....	538
Picks.....	561
Ring Curette.....	589
Sickle Knives.....	571
PAPAVERO	
Bayonet Chisel.....	679
PAPAVERO	
Chisel.....	1129
PAPAVERO-CASPAR Transsphenoidal	
Speculum.....	673
PAPAVERO-HARTMANN (CASPAR)	
Transsphenoidal Speculum.....	673, 1128
Parametrium Clamps.....	1255, 1256
PARKER Retractors	198
PARKER-KERR Intestinal Forceps	131
PARKES	
Hump Gouge.....	581, 679
Nasal Rasp.....	677
PARKS Rectal Retractor	284
PARRY-COOLEY Atraumatic Anastomosis	
Clamp.....	474
PARSONNET	
Aorta Clamp.....	480
Epicardial Retractors.....	272, 508
PARTSCH	
Chisels.....	799
Gouges.....	800
Passing Needles.....	709
Passing Probes, Tendon.....	777
Patella Forceps.....	912
Patent Ductus Clamps/Forceps, Atraumatic	
.....	426, 464, 465
PATON Spatula and Spoon	855
PAUL Tendon Hook	191, 783
PAYR Intestinal Clamps	123
PEAN Hemostatic Forceps	151, 152, 154
PEAPOD Disc Rongeurs	1047
PECK-JOSEPH Nasal Scissors	604
PEDERSON Vaginal Specula	1265, 1266
Pediatric	
Anastomosis Clamps, Atraumatic..	463, 467, 468
Clamps/Forceps, Atraumatic.....	412, 459, 461
Ear Specula.....	562, 566
Forceps.....	636
Multi-Purpose Clamps, Atraumatic.....	468
Nasal Specula.....	671, 672
Ostrum Antrum Punch Forceps.....	635
Vascular Clamps, Atraumatic.....	389, 409, 410
PEET Splinter Forceps	781

	PAGE
PELKMANN Sponge Forceps	1214
Pelvis Retractors	238, 239
PENFIELD	
Dissectors.....	1114, 1115
Watchmaker Forceps.....	1079
Penis Clamps	1312
PENNINGTON	
Elevators.....	662
Tissue Holding Forceps.....	116
PENNYBACKER	
Bone Rongeur.....	1027
Probe Dissector.....	1116
Percussion Hammer	324
Perforating Needles	537
Perineal Retractors	280, 285, 1261
Periosteal Elevators	498, 500-502, 659, 660,
.....	662-664, 676, 805, 960,
.....	962-967, 969-971, 1153
Peripheral Clamps, Atraumatic	413,
.....	435-437, 459
PERKINS Antrum Retractors	656
PERTHES Reamer	997
PHANEUF Hysterectomy Forceps	1251
Picks	
Ear.....	558-561
Tissue.....	1120
PIERCE Submucous Dissector	662
Pigtail Lacrimal Probes	865
Pillar Retractors	725
PIPER Obstetrical Forceps	1235
PISACANO Nucleus Rotator	853
Pituitary	
Curettes.....	1129, 1131-1134,
.....	1137, 1138, 1140, 1141
Dissectors.....	1131, 1133, 1135, 1141
Enucleators.....	1130, 1132, 1133, 1139
Forceps.....	1136, 1141, 1143
Hooks.....	1132, 1135, 1139, 1140
Raspatories.....	1130, 1140
Rongeurs, Micro.....	1048
Scissors.....	1136, 1142, 1143
Spoons.....	1138, 1141
Placenta	
Forceps.....	1240-1245
Scoops.....	1294
Plaster	
Breakers.....	886
Scissors.....	883-885
Shears.....	884
Spreaders.....	886

	PAGE
Plastic Scissors	596, 604, 750, 758
PLESTER Sickle Knife	572
PLESTER-PAPARELLA-WEITLANER Retractor	
.....	556
Pliers	
Flat Nosed.....	898
Needle Nose.....	805, 887
Utility.....	898
Vise Grip.....	896
Wire Bending.....	898
Wire Cutting.....	806, 888-891, 893
Wire Extraction.....	892, 897
Wire Holding.....	895, 896
Pneumatic KAIRison Bone Punch	1058, 1059
POLITZER Pediatric Ear Speculum	562
Polyp Snares	650
Polyp Uterine Forceps	1226, 1228
POOLE Suction Cannulas	311
POTTS	
Anastomosis Clamps.....	463
Arteriotomy Scissors.....	340
Liver Clamps.....	479
Tenotomy Scissors.....	333, 753
Vascular Scissors.....	340
POTTS-DE MARTEL Cardiovascular Scissors ..	337
POTTS-SMITH	
Cardiovascular Scissors.....	335, 336
Dissecting Scissors.....	331
SuperCut Scissors.....	48, 336
Thumb Forceps.....	103, 374
Vessel Scissors.....	336
POZZI Uterine Tenaculum Forceps	1217, 1220
PRATT	
Ethmoid Curette.....	589
Rectal Probes.....	297
Rectal Speculum.....	286
Uterine Dilators.....	1285
Uterine Tenaculum Forceps.....	1223
PRATT-SMITH Hemostatic Forceps	126
Preparation Base	593
PRIBRAM Suction Tube with Thumb Control	
.....	322
PRICE Muscle Biopsy Clamps	150
PRICE-THOMAS Bronchus Forceps	400
Probes	294, 296, 297, 507, 1120
Dissecting.....	1019, 1116
Fistula.....	295, 296, 298, 299
Gall Duct.....	299
Jannetta Style.....	1111
Lacrimal.....	865

Alphabetical Index

P - R

PAGE	PAGE	PAGE
Micro.....1086	Pituitary 1130, 1140	Cheek 215
Nasal 686	Rasps	Cobra..... 923, 924
Rectal..... 297	Antrum 674	Decompression..... 1155
Tendon Passing..... 777	Bone..... 674-677, 805, 957-959	Dura..... 1118
Uterine..... 1286, 1287	Nasal 584, 674, 675, 677, 958, 965	Epicardial..... 272, 508
Profunda Clamps, Atraumatic..... 431	RAY Currettes..... 1129	Retractors
Prong Micro Hooks..... 192	Reamers..... 996, 997	Eye 724, 848-850
Prostate Retractors..... 1301	RECAMIER Uterine Currettes..... 1289	Femur..... 282
PROVIDENCE-HOSPITAL Hemostatic Forceps	Rectal	Goiter..... 213, 723
..... 165	Biopsy Forceps..... 149	Hook..... 191, 193, 291, 783
Punches	Probes..... 297	Initial Incision 956
Antrum 623, 635-637, 1137	Retractors..... 284-286	Joe's Hoe..... 237
Aorta 504	Scissors..... 21-23	Knee 917-919
Bone 629, 630, 1050-1057	Specula..... 285-289	Laminectomy..... 952
Dermal..... 797	REILL	Lid 790, 845-847, 849, 850
Eye 877	Micro Needle Holders..... 358	Lung..... 516
Forceps 623	Reposition Forceps 905	Nasal 652-656
Pneumatic Bone..... 1058, 1059	Wire Cutter 890	Nerve Root..... 1154-1156
Sinus..... 630	REINHOFF	Orbital..... 724, 848
Sternum 503	Rib Spreaders 527	Pelvis..... 238-240
PUTTERMAN-Type Muscle Forceps..... 837	Swan Neck Clamp..... 184	Perineal 280, 285, 1261
PUTTI Bone File..... 959	Removal Forceps, ScalpFix 1069	Pillar 725
Pynchon Suction Tube 739, 798	Renal Artery Clamps, Atraumatic..... 469	Prostate..... 1301, 1302
Q	Renal Retractor Blade..... 270	Rectal..... 284-286
QUERVAIN Periosteal Elevator 970	Reposition Forceps..... 903, 905, 906	Scapula..... 515
QUIRE Ear Forceps..... 541	RESANO	Self Retaining..... 272-285, 508, 556, 557,
QUISLING Intranasal Hammer..... 694	Cardiac Valve Forceps 372 656, 657, 791-793, 847,
R	Cartilage Scissors..... 885 942-949, 1157-1162, 1261
RAABE	Titanium Grasping Forceps..... 380	Spinal..... 920, 925, 953-955
Atraumatic Micro Suction Tubes..... 1147	Retractor System, Spine..... 953-955	Spoons..... 324
Micro Suction Tubes..... 1147	Retractors..... 194-202, 204-214, 507,	Spring Wire..... 273, 792
RAGNELL 513, 514, 557, 651, 655,	Sternotomy 524-533
Dissecting Scissors 26 656, 786-790, 921, 922, 941	T Handle..... 919
Retractor..... 195	Abdominal..... 215-241, 243-254, 1262	Thumb..... 204
RALKS Hand Drill 995	Abdominal, Malleable 242	Thyroid..... 214, 279
RAMPLEY Sponge Forceps..... 143	Abdominal, Ribbon..... 235	Tracheal..... 720
RANDALL	Antrum 656	Universal Ring Retractor System..... 255-271
Endometrial Biopsy Curette..... 1288	Aortic Valve 508	Universal Ring Retractor System,
Kidney Stone Forceps 132, 133, 1308, 1309	Appendectomy..... 240	Bookwalter-Style..... 270
RANDOLPH Cyclodialysis Cannula 869	Atrial 511, 512	Urethra 1301
RANEY	Atrium..... 509, 510	Urology..... 1316, 1317
Applying & Removing Forceps..... 1069	Bladder 1314, 1318	Uvula..... 723
Scalp Hemostasis Clip 1069	Bone 926-939	Vaginal 279-281, 1261,
RANKIN Hemostatic Forceps..... 169	Bookwalter-Style Universal Ring Retractor 1271-1273, 1278-1281
Raspatories..... 676, 804, 959, 965	System 257, 258, 260,	Vein..... 203-205, 1155, 1315, 1318
Micro..... 1087, 1112, 1113, 1119 262-266, 268, 270, 271	REVERDIN Needles..... 1298
	Breast..... 788, 789	REYNOLDS Tenotomy Scissors..... 607, 752
	Bulb 1316	REYNOLDS-JAMESON Tenotomy Scissors
	Cerebellar 278 25, 607, 752
	Cerebellum..... 947	Rhoton Style Cup Forceps..... 1048

	PAGE
Rib	
Contractors.....	525
Elevators.....	499
Shears.....	502, 503
Spreaders.....	518-533
Rib	
Strippers.....	499
RIBBON	
Malleable Spatulas.....	235
RICH Corneal Scissors.....	825
RICHARDSON Retractors.....	220, 221, 264
RICHARDSON-EASTMAN Retractors.....	219
RIGBY Vaginal Retractor.....	1261
Right Angle	
Clamps.....	172, 173, 180-182, 184, 185
Forceps.....	172-185, 392
Forceps & Clamps.....	181-185
Ring	
Curettes.....	589
Cutters.....	802
Laparotomy.....	243
Retractor System, Universal.....	255-271
ROCHARD Abdominal Retractors.....	241
ROCHESTER-CARMALT Hemostatic Forceps.....	159
ROCHESTER-FERGUSON Scissors.....	28
ROCHESTER-OCHSNER Hemostatic Forceps	156, 158, 396
ROCHESTER-PEAN Hemostatic Forceps.....	153
ROEDER Towel Clamp.....	187
ROETTGEN-RUSKIN Bone Rongeur.....	1030
ROGERS Submucous Dissector.....	662
Roller Knives.....	574
ROLLET Hook Retractors.....	191, 783
Rongeurs.....	590, 631, 641, 1035-1049
Bone.....	629, 631, 632, 699-703, 1021-1034
Detachable, Noir.....	1035, 1036
Disc.....	1047
Laminectomy.....	1053
Mastoid.....	590
Micro Pituitary.....	1048
Nasal Cut.....	625
Synovectomy.....	1020
RONIS Adenoid Nasal Forceps.....	637
Rose Gold	
Bipolar Forceps.....	1174-1176, 1183, 1187, 1191, 1193
Bipolar Forceps, Disposable.....	1196, 1197
ROSE Retractor.....	198

	PAGE
ROSEN	
Knife/Elevator.....	573
Suction Tubes.....	579
ROSS Aortic Valve Retractors.....	508
ROSSER Crypt Hook.....	299
Round Cutting Knives.....	573
ROUX Retractors.....	199, 200
ROWLAND Bone Cutting Forceps.....	638
ROYCE Ear Knife.....	573
RUBIN Osteotomes.....	685, 985
RUBIO DUROGRIP TC Wire Twisters.....	74
RUDD Hemorrhoidal Ligator.....	290
RUEDEMANN Lacrimal Dilator.....	866
Rulers.....	323, 1065
RUSKIN Bone Rongeurs.....	1029
RUSKIN-LISTON Bone Cutting Forceps.....	1062
RUSSEL-DAVIS Tongue Blades.....	736
RUSSIAN Tissue Forceps.....	84
RYDER	
Dia Dust Needle Holders.....	367
DUROGRIP TC Needle Holders.....	66, 369
Titanium Dia Dust Needle Holders.....	367
S	
Saber-Back Scissors.....	601
SACHS	
Suction Cannulas.....	322, 691, 1152
Vein Retractors.....	1155
Saddle Hooks.....	787
SAENGER Placenta & Ovum Forceps.....	1244
SAGE Tonsil Snare.....	727
SAMII	
Knives for Tumor Tissue.....	1124, 1125
Lancet Knife.....	1125
SANDERS Vasectomy Forceps.....	1312
SAROT	
Bronchus Forceps.....	398
DUROGRIP TC Needle Holders.....	62
Hemostatic Forceps.....	392
Intrathoracic Artery Forceps.....	393
SATINSKY	
Vena Cava Clamps.....	401
Vena Cava Scissors.....	330
SATTERLEE Amputation Saw.....	309
SAUER Eye Speculum.....	847
SAUERBRUCH	
Retractors.....	212, 223
Rib Shears.....	503
SAUERBRUCH-CORYLLOS Bone Rongeurs.....	1033

	PAGE
SAUNDERS-PAPARELLA	
Ear Hook.....	554
Needles.....	538
Saws	
Amputation.....	309
Metacarpal.....	310
Nasal.....	676
Saws	
Wire.....	310, 1072, 1073
SAWYER Rectal Retractors.....	285
SAYRE Periosteal Elevators.....	960
Scalp Clips	
Applicators.....	1068
Removal Forceps.....	1069
Scalp Flap Forceps.....	1070
Scalp Hemostasis Clips	
Metal.....	1069
Plastic.....	1069
Scalpels	
Blades, Sterile.....	306
Handles.....	300-305, 1299
Micro Blades, Sterile.....	301, 302
Sterile.....	307
ScalpFix	
Applicators.....	1068
Removal Forceps.....	1069
Scapula Retractors.....	515
SCHEDE Bone Curettes.....	999
SCHEER Wire Crimper.....	551
SCHEPENS Orbital Retractor.....	849
SCHERBACK Vaginal Specula.....	1277
SCHINK Skin Graft Knife.....	795
SCHMID Vessel Irrigation Cannula.....	497
SCHMIEDEN-TAYLOR Dura Scissors.....	329
SCHNIDT Tonsil Clamps.....	161, 713
SCHOCKET Scleral Depressor.....	850
SCHROEDER Uterine Tenaculum Forceps	1218, 1219
SCHUHMACHER Umbilical Cord Scissors.....	1211
SCHUKNECHT	
Ear Hook.....	554
Retractor.....	557
Roller Knives.....	574
Wire Crimper.....	551
SCHUMACHER	
Biopsy Forceps.....	1247
Bone Retractor.....	937
SCHUMACHER-WAGNER Bone Retractor.....	937
SCHWARTZ Micro-Vessel Clamps.....	488
Scissors.....	329, 596, 826, 827

Alphabetical Index

S

	PAGE
Abdominal.....	21
Arteriotomy.....	329, 339, 340
Artery.....	340
Bandage.....	7-10, 880-883, 885
Bipolar Dissecting.....	1168
Bulldog.....	596
Capsulotomy.....	822, 827
Scissors	
Cardiovascular.....	335-337
Cartilage.....	604, 758, 885
Conjunctival.....	818
Corneal.....	823-825
Coronary Artery.....	338, 342
Crown.....	807
Delicate.....	24-27, 42, 43, 45, 328, 329, 331-333, 605-610, 748-755, 763, 764, 812-816
Dissecting.....	11-20, 26, 28, 49-52, 329-332, 335, 349-352, 606, 613, 706, 753-755, 759, 765, 766
Dura.....	329
DUROTIP TC Delicate.....	611, 707, 760, 819
DUROTIP TC Dissecting.....	30-40, 344-347, 762, 1207, 1209
DUROTIP TC Dorsal.....	611
DUROTIP TC Facelift.....	761
DUROTIP TC Iris.....	611, 760, 819
DUROTIP TC Operating.....	29
DUROTIP TC Par.....	760
DUROTIP TC Strabismus.....	612, 819
DUROTIP TC Suture.....	29
DUROTIP TC Tenotomy.....	612, 760
DUROTIP TC Uterine.....	1207, 1208
DUROTIP TC Vascular.....	343
DUROTIP TC Wavecut Dissecting.....	37-40, 346, 347, 762, 1209
DUROTIP TC Wavecut Iris.....	611, 761, 820
DUROTIP TC Wavecut Ligature.....	41, 348
DUROTIP TC Wavecut Strabismus.....	820
DUROTIP TC Wavecut Uterine.....	1209
DUROTIP TC Wire.....	30, 343, 807
Ear Micro.....	536
Enucleation.....	817
Episiotomy.....	1211
Eye.....	817
Face Lift.....	606, 758
Gum.....	707
Iris.....	24, 331, 608, 748, 749, 812, 813, 826, 827
Laryngeal Micro.....	708

	PAGE
Ligature.....	7, 757, 758
Lower Lateral.....	601, 757
Micro.....	341, 353-356, 708, 767, 768, 821-823, 825, 828, 1074-1077, 1083, 1088-1092, 1096-1099, 1101
Nail.....	887
Nail Splitting.....	887
Scissors	
Nasal.....	596-604
Neonatal.....	340
Nerve Sparing.....	1300
Noir Supreme Cut.....	49-52, 349-352, 613, 765, 766
Offset.....	339
Operating.....	14, 328
Otologic.....	536
Pituitary Dissecting.....	1143
Pituitary Micro.....	1136, 1142
Plaster.....	883-885
Plastic.....	596, 604, 750, 758
Rectal.....	21-23
Rhinoplasty.....	597
Saber-Back.....	601
SENSATION Micro.....	1088-1092
Stitch.....	818, 826, 828
Strabismus.....	25, 610, 755, 816
SuperCut.....	42-48, 328, 333, 334, 336, 342, 614, 753, 756, 759, 763, 764
Suture.....	2-7, 14, 15, 749, 757
Tenotomy.....	25, 332, 333, 607-610, 750-753, 814, 815, 828
Tonsil.....	706
Umbilical Cord.....	1210, 1211
Uterine.....	1202-1206
Utility.....	817, 828
Valve Leaflet Excision.....	340
Vascular.....	330, 336, 338-341
Vein.....	353
Vena Cava.....	330
Vessel.....	336, 338, 339, 353, 356, 768, 1076
Wire.....	23
Wire Cutting.....	1076
XS Micro.....	1096-1099
Scleral Plug Forceps	838
Scoops	
Gall Stone.....	293, 298, 299
Micro.....	1086, 1113
Ovum.....	1294
Placenta.....	1294
Secretion.....	1288

	PAGE
SCOVILLE	
Bipolar Forceps.....	1174, 1177, 1192
Bipolar Forceps, Disposable.....	1196
Bone Curette.....	1001
Nerve Root Retractors.....	1154
SCOVILLE-RICHTER Laminectomy Retractor	952
Screws, Myoma	1233
SCUDDER Intestinal Forceps	136
SEBILEAU Periosteal Elevator	969
Secretion Scoops	1288
SEDILLOT	
Periosteal Elevators.....	963
Retractors.....	963
SELDIN Raspatories	804
Self Retaining	
Retractors.....	272-285, 508, 556, 557, 656, 657, 791-793, 847, 942-949, 1157-1162, 1261
Speculum.....	1127
SELLHEIM Obstetric Lever	1239
SELMAN	
Vessel Clamps.....	433
Tissue Forceps.....	85, 371
SELVERSTONE Rongeurs	1048
SEMB	
Bone Holding Forceps.....	908
Bone Rongeur.....	1034
Lung Retractors.....	516
Periosteal Elevators.....	500
Suture Forceps.....	403
SEMKEN	
Delicate Dressing Forceps.....	89
Delicate Tissue Forceps.....	89
DUROGRIP TC Tissue Forceps.....	104
SEMKIN	
Bipolar Forceps, Disposable.....	1196
Bipolar Forceps, Rose Gold.....	1176
Forceps, Bipolar.....	1186
SEMM	
Abdominal Retractor.....	254
Vaginal Speculum.....	1264
SENN Retractors	194
SENN-MILLER Retractors	194
SENSATION	
Micro Forceps.....	1093
Micro Needle Holders.....	1095
Micro Scissors.....	1088-1092
Micro Tumor Grasping Forceps.....	1094
Septum	
Displacer.....	658

	PAGE
Dissectors	662
Elevators	660, 662
Forceps	623, 624, 648
Gouges.....	678, 679
Knives.....	687
Morselizer Forceps.....	649
Needles.....	615
Septum	
Specula.....	665, 667, 668
Serrefine Clamp	840
SEUTIN Plaster & Bandage Scissors	885
SEWALL	
Antrum Elevator.....	662
Orbital Retractor.....	724, 848
SEYFFERT Vaginal Specula	1264
SHAHINIAN Lacrimal Cannula	869
SHALLCROSS Cystic Duct Forceps	129
SHAMBAUGH Micro Ear Hooks	555
SHAPLEIGH Ear Curettes	586
Sharp Hooks	1120
Shattering Needles	537
SHEA	
Bone Curettes	588
Ear Curettes.....	586
Ear Speculum Holder.....	567
Shears	
Plaster.....	884
Rib.....	502, 503
SHEEHY	
Fascia Press.....	592
Ossicle Holding Forceps.....	539
SHEETS-MCPHERSON Forceps	842
SHEPARD Lens Holding Forceps	838
Sickle Knives	571, 572, 574
SIEBEL Flap Lifter and Spatula	854
SIEBOLD Uterine Scissors	1205
SIMCOE Cannulas	872, 875
SIMON	
Bone Curettes	1003
Fistula Hooks.....	193
Vaginal Retractors.....	1281
SIMPSON	
Obstetrical Forceps.....	1236
Uterine Probe	1287
SIMPSON-BRAUN Obstetrical Forceps	1234
SIMS	
DUROTIP TC Uterine Scissors	1207
DUROTIP TC Wavecut Uterine Scissors.....	1209
Rectal Speculum	286
Uterine Curettes.....	1290

	PAGE
Uterine Probes	1286
Uterine Scissors.....	1202-1203
Vaginal Retractors.....	1271
Vaginal Specula.....	1271
SIMS-MAIER Sponge Forceps	142, 1214
SIMS-SIEBOLD Uterine Scissors	1206
Sinoscopy, Trocar and Cannula	616
SINSKEY	
II Titanium Lens Manipulating Hook.....	857
Lens Manipulating Hook	856, 857
Tying Forceps.....	837
SINTRAM Bipolar Forceps	1182
Sinus	
Cup Forceps	638
Curettes.....	695, 696
Punches.....	630
SKILLERN Sinus Probe	686
Skin	
FOX Dermal Curettes	797
Graft Knives	795-797
Hooks.....	190-192, 651, 783-785
Retractors, Automatic.....	274, 791
Skull Base Instruments	1104, 1105
Skull Opening	310, 1068-1073
SLADE LASIK Cannula	871
SLOANE LASIK Spatula	851
SMILLIE	
Meniscotomes.....	899
Retractors.....	921
SMITH-BUIE Rectal Retractor	284
SMITH-PETERSEN Gouges	979
SMITH-PETERSON	
Bone Rongeur	1030
Osteotomes.....	983
SMITHWICK Nerve Hooks	1122
Snares	
Ear.....	553
Nasal.....	650
Tonsil.....	726-728
SNELLEN Ear Curette	587
SOFFERMAN Needle Holder	617
SOMER Uterine Elevating Forceps	1230
SONNENSCHNEN Nasal Speculum	672
Sounds, Urethral	1319-1322
Spatulas	
Brain.....	1163-1165
Enderterectomy.....	494
Eye	851, 852, 854, 855, 859
Lung.....	224-226, 516, 517
Malleable.....	235

	PAGE
Micro.....	492
Nasal	235, 663
Vascular.....	494, 1117
Specula	
Ear.....	562-567
Eye	845-847
Nasal.....	666, 667, 669-672
Specula	
Rectal.....	285-289
Self Retaining	1127
Septum.....	665, 667, 668
Transsphenoidal	673, 1127, 1128
Vaginal	1263-1277
SPENCER	
DUROGRIP TC Micro Needle Holders	360
Suture Scissors.....	7, 757
SPENCER-WELLS Hemostatic Forceps	151
Spermatic Cord Fixation Clamp	1311
Spinal	
Curettes.....	1000, 1002, 1008-1010
Curettes, Black Handle.....	1012, 1013
Impactors.....	993
Retractor System	953-955
Retractors.....	920, 925
Splanchnic Retractor Blade	270
Splinter Forceps	101, 781
Sponge Forceps	141-148, 715, 718, 719, 1213, 1214, 1227
Spongiosa Gouges	977, 978
Spoons	324
Pituitary	1138, 1141
Skull Base	1104
SPRATT Mastoid Curettes	698
Spreaders	
Lamina.....	950, 951
Plaster.....	886
Rib.....	518-533
Spring Wire Retractors	273, 792
SPURLING Rongeurs	632, 1042
ST. CLAIR Adenoid Forceps	712
ST. MARKS	
Deep Pelvic Retractor Blade for URRS.....	266
Pelvis Retractors.....	238, 239
Perineal Retractor.....	285
ST. MARTIN Delicate Tissue Forceps	834
STAMM Bone Cutting Forceps	639, 1060
STAMMBERGER	
Circular Punch Forceps.....	625
Forceps	637
Stapes Pick	558

Alphabetical Index

S - T

PAGE	PAGE	PAGE
Staple Remover..... 324	Rib..... 499	TAEGER Bone Lever..... 972
Steel Rulers..... 323, 1065	Tendon..... 780	TAKAHASHI Rongeurs..... 631
STEINER-AUVARD Vaginal Specula..... 1276	Vein..... 491	Tampers, Bone..... 694
STELLBRINK Synovectomy Rongeurs..... 1020	STRONG Aorta Clamp..... 421	Tamps, Bone..... 993
STELZNER Rectal Scissors..... 22	STRUCK Infant Rib Spreaders..... 533	Tangential Clamps, Atraumatic..... 453, 454
Sterile	STRULLY Dissecting Scissors..... 330	TAUFIC Cholangiography Clamp..... 125
Scalpel Blades..... 301, 302, 306	STUBBS Adenoid Curette..... 742	TAYLOR
Sterile	STUEMPEL-VOSS Nasal Forceps..... 640	Percussion Hammer..... 324
Scalpels..... 307	Submucous Dissectors..... 662	Spinal Retractors..... 920
Sternal Retractor..... 531	Suction	TEALE Uterine Tenaculum Forceps..... 1223
STERN-GILLS Scissors..... 826	Adapter..... 579	TEBBETTS
Sternotomy Retractors..... 524-533	Cannula, Skull Base..... 1105	Breast Retractors..... 788, 789
Sternum Chisels..... 503	Cannulas & Tubes..... 311-314, 316-318, 320,	Knife Handle..... 796
Sternum Punches..... 503 322, 576-579, 689-691, 739,	Teeth Protector..... 730
STEVENS 798, 1145, 1146, 1151, 1152	Tenaculum Forceps, Uterine..... 1216-1226
BipoJet Bipolar Dissecting Scissors..... 1168	Dissectors..... 692, 798, 1150	Tendon
SuperCut Scissors..... 42, 43, 614	Tubes..... 1148	Holding Forceps..... 778
Tenotomy Hook..... 861	Tubes, Atraumatic..... 315, 1147, 1149	Hooks..... 191, 203, 783, 787
Tenotomy Scissors..... 608-610,	Tubes, Dissecting..... 322, 1150	Interlacing Forceps..... 780
..... 750-752, 814, 815	Tubes, Fukushima Style..... 321, 1144, 1147	Passing Probes..... 777
STEVENSON Grasping Forceps..... 1047	Tubes, Micro..... 1146-1148	Pulling Forceps..... 779
STEWART Crypt Hook..... 291	Tubes, MIN Noir..... 1145	Seizing Forceps..... 777, 778
STIEGLITZ Splinter Forceps..... 781	Tubes, Slotted..... 319, 1150, 1151	Strippers..... 780
STILLE	SuperCut Scissors..... 42-48, 328, 333, 334, 336,	TENNANT Tying Forceps..... 837
Bone Rongeur..... 1032 342, 614, 753, 756, 759, 763, 764	Tenotomy
Chisels..... 974	Suture	DURO TIP TC Scissors..... 612, 760
Dissecting Scissors..... 11	DURO TIP TC Scissors..... 29	Scissors..... 25, 332, 333, 607-610,
Gouges..... 978	Forceps..... 164, 174, 403, 414, 839, 841 750-753, 814, 815, 828
Kidney Clamps..... 1305	Holding Frame..... 1302	TENZEL Bipolar Forceps..... 1185
Osteotomes..... 982	Micro Forceps..... 373, 773-776, 833, 835, 836	TESSIER Osteotome..... 682
STILLE-BARRAYA Cardiovascular Forceps..... 84	Pushers..... 1123	THOMAS Uterine Curettes..... 1292
STILLE-RUSKIN Bone Rongeur..... 1033	Removal Forceps..... 91	THOMS-GAYLOR Biopsy Forceps..... 1246
Stitch	Scissors..... 2-7, 14, 15, 749, 757	Thoracic
Cutters..... 306	SWEET Sternum Punch..... 503	Artery Forceps..... 393
Scissors..... 818, 826, 828	Swivel Knives..... 687	Right Angle Clamps..... 173, 180
STOCKMANN Penis Clamp..... 1312	SYME Suture Needle..... 78	Tissue Forceps..... 394
Stopcock Luer Adapter..... 692	Synovectomy Rongeurs..... 1020	Thoracoscopy Forceps..... 395
STOREY Hemostatic Forceps..... 159	SYPERT	THOREK Dissecting Scissors..... 329
Strabismus	Bone Rongeur..... 1033	THORNTON Swivel Fixation Ring..... 862
DURO TIP TC Scissors..... 612, 819	Kerrison Bone Punch..... 1050	THORPE
DURO TIP TC Wavecut Scissors..... 820	Rongeur..... 1046	Conjunctival Fixation Forceps..... 839
Noir Dissecting Scissors..... 613, 765	Spinal Impactors..... 993	Corneal Forceps..... 839
Scissors..... 25, 610, 755, 816	Syringes, Tonsil..... 743	Thumb
STRAND	SYSTRUNK Nail Splitting Scissors..... 887	Dia Dust Forceps..... 375
Osteotomes..... 801	T	DUROGRIP TC Forceps..... 103
STRASSBURGER Tissue Forceps..... 83	TABB	Forceps..... 93
STRATTE DUROGRIP TC Needle Holders..... 72, 370	Flapp Knife..... 575	Retractors..... 204
STRAUSS Penis Clamp..... 1312	Myringotomy Knife..... 575	Thyroid Retractors..... 214, 279
Strippers		TIECK-HALLE Pediatric Nasal Speculum..... 671
Enderterectomy..... 493		TILLEY Ear Forceps..... 540

Alphabetical Index

V - W

	PAGE
Varix	
Dissectors	492
Extractors	492
Vascular	
Clamps.....	404-481, 483
Dilators.....	494-496
DUROTIP TC Scissors.....	343
Scissors.....	330, 336, 338-341
Vascular	
Spatulas	494, 1117
Tissue Forceps	98-100, 371
Titanium Clamps	381-389
Vasectomy Clamps.....	1311, 1312
Vein	
Hooks.....	193
Retractors.....	203-205, 1155, 1315, 1318
Scissors	353
Strippers	491
Velvet Eye Aspirating Tubes	739
Vena Cava	
Clamps.....	400, 401, 452
Scissors.....	330
Ventricular Puncture Cannulas.....	1152
VERBRUGGE Bone Holding Forceps.....	914
VERBRUGGE-MUELLER Bone Retractors.....	938
Vessel	
Clamps/Clips.....	433, 488-490
Clips.....	808, 809
Forceps	371
Hooks	506, 507, 785, 1121
Knife.....	1125
Irrigation Cannulas.....	497
Scissors.....	336, 338, 339
Scissors, Micro	353, 356, 768, 1076
VIENNA Nasal Speculum.....	669, 670
Vise Grip Pliers.....	896
WISE Micro Suture Forceps.....	774, 833
VOGEL Adenoid Curette.....	742
VOLKMANN	
Bone Curettes	697, 999
Bone Hooks.....	207, 941
Retractors.....	206-208, 941
Von GRAEFE	
Iris Forceps.....	844
Vulsellum Forceps, Uterine.....	1221, 1224

	PAGE
W	
WAGENER Ear Hooks.....	555
WAGNER	
Bone Lever.....	933
Gouges.....	979
Mallet	992
Periosteal Elevators.....	967
Rongeurs.....	1039, 1044
WALLICH Placenta/Ovum Scoop.....	1294
WALSHAM Septum Forceps.....	648
WALTHER Dilator-Catheter	1322
WANGENSTEEN	
DUROGRIP TC Needle Holders	69
WANGENSTEEN	
DUROGRIP TC Tissue Forceps.....	105
Needle Holders	57
WATSON-CHEYNE Dissectors.....	1019
WATSON-WILLIAMS Ethmoid Forceps..	644, 645
WATZKE Sleeve Spreading Forceps	844
WAUGH Delicate Tissue Forceps.....	97
Wavecut Dissecting DUROTIP TC Scissors	37-40, 346, 347, 762, 1209
WEARY Nerve Hook.....	1122
WEBER Atraumatic Aortic Clamps	445, 446
WEBSTER	
DUROGRIP TC Needle Holders	61
Needle Holders	53
WEDER Tongue Depressors	722
WEIL Nasal Forceps.....	640
WEIL-BLAKESLEY Rongeurs	641
WEINER Antrum Rasp Trocar.....	674
WEINGARTNER Ear Forceps.....	540
WEINGERG Vagotomy Retractor	237
WEITLANER Retractors	275, 276, 278, 656
WELLER	
Cartilage Forceps	901
Dissecting Scissors	20
WELLS Enucleation Spoon	850
WERTHEIM	
Atraumatic Compression Clamps	1257
Atraumatic Parametrium Clamps.....	1255
DUROTIP TC Uterine Scissors	1207
Hysterectomy Forceps.....	1256
Parametrium Clamps.....	1256
Uterine Scissors	1204
WERTHEIM-CULLEN Compression Clamps..	1257
WEST	
Lacrimal Cannula.....	875
Nasal Dressing Forceps.....	622

	PAGE
WESTCOTT	
Stitch and Utility Scissors.....	828
Tenotomy Scissors.....	828
WHEELER Atraumatic Vessel Forceps.....	371
"Whirlybird" Excavators	583
WHITE Tonsil Seizing Clamps.....	716
WHITEHEAD-JENNINGS Mouth Gags	730
WHITMAN-SHEPHERD Capsule Polisher.....	851
WIENER Hysterectomy Forceps.....	1254
WIET Bayonet Otologic Scissors	536
WIKSTROEM Dissecting Forceps.....	183
WILDE	
Bayonet Forceps.....	88, 620
Ethmoid Nasal Forceps	643
WILDE	
Nasal Forceps.....	646
Nasal Polyp Snare.....	650
WILDE-Type Backbiter Forceps.....	647
WILDER Lacrimal Dilator.....	866
WILLET-DEMARTEL Scalp Flap Forceps.....	1070
WILLIAM-HOUSE Suction Irrigator.....	578
WILLIAMS	
Disectomy Forceps.....	1049
Lacrimal Probes	865
Retractors.....	947
WILLIGER	
Bone Curettes	697, 998
Bone Elevator	960
Periosteal Elevators.....	969
WILLS Hospital Utility Forceps.....	844
WILMER Conjunctival Scissors	818
WILSTE-GELPI Retractor	280
WINKELMANN Circumcision Clamps.....	1313
WINTER Placenta & Ovum Forceps... 1241-1243	
Wire	
Bending Pliers	898
Catheter Guide	1319
Cutters.....	552, 806, 887-891, 893
DUROGRIP TC Twisters.....	73, 74
DUROTIP TC Scissors.....	30, 343, 807
Ear Snares.....	553
Extraction Pliers.....	892, 897
Forceps	552
Holding Forceps.....	892, 895
Holding Pliers.....	895, 896
Micro Scissors.....	1076
Nasal Snare.....	650
Saws.....	310, 1072, 1073
Scissors.....	23
Tonsil Snare	728

PAGE	PAGE	PAGE
WITTNER Biopsy Forceps..... 1250	Prostatic Tractor..... 1314	
WOLFF Plaster Breakers..... 886	YU-HOLTGREWE Malleable Retractor Blade.. 271	
WOODSON		
Dura Separator 1124	Z	
Elevator 1117	ZANGER Heparin Cannulas 497	
Spatulas 1117	ZAUFAL-JANSEN Bone Rongeur 703, 1029	
WRIGHT Fascia Needle..... 538	Zelpi-Type Retractors 949	
WULLSTEIN	ZENKER	
Micro Ear Forceps..... 549	Dissecting Forceps..... 178	
Retractors..... 277, 657	Ligature Forceps..... 178	
WYLIE	Retractors..... 227	
Atraumatic Vascular Clamps..... 422-425	ZIELKE Gouges 978	
Renal Vein Retractor..... 1315	ZIPSER Meatus Clamp..... 1313	
X	ZOELLNER Suction Tubes..... 579	
XS		
Micro Forceps 1098		
Micro Scissors..... 1096-1099		
Tumor Grasping Forceps..... 1099		
Y		
YANKAUER Suction Cannulas Et Tubes .. 316, 317		
YASARGIL		
Arachnoid Blades 301		
Dissectors 1114		
Galea Hooks..... 1070		
Grasping Forceps..... 1080		
Ligature Forceps..... 1123		
Ligature Guides..... 1123		
Micro Dissectors..... 1119		
Micro Forceps..... 1078, 1080		
Micro Needle Holders..... 1082		
Micro Raspatories..... 1119		
Micro Scissors..... 1074-1076		
Micro Vessel Scissors..... 353, 768		
Rongeurs..... 1039		
Self Retaining Retractor, LEYLA..... 1158, 1159		
Suction Tubes..... 1148		
Tumor Grasping Forceps..... 1080		
Wire Cutting Micro Scissors..... 1076		
YASARGIL Style Bipolar Forceps..... 1169-1172		
YASARGIL-NICOLA Micro Forceps..... 1143		
YASARGIL-SAMII Tumor Grasping Forceps.. 1081		
YEOMAN Rectal Biopsy Forceps 149		
YOUNG		
Anterior Retractor 1317		
Bulb Retractor..... 1316		
Lateral Retractor..... 1317		

Notes

All rights reserved. Technical alterations are possible. This leaflet may be used for no other purposes than offering, buying and selling of our products. No part may be copied or reproduced in any form. In the case of misuse we retain the rights to recall our catalogs and price lists and to take legal actions.

©2017 AESCULAP. ALL RIGHTS RESERVED. PRINTED IN THE USA.
Aesculap is an equal opportunity employer

Aesculap, Inc. | 3773 Corporate Parkway | Center Valley, PA | 18034
Phone 800-282-9000 | Fax 610-791-6886 | www.aesculapusa.com

Aesculap, Inc. - a B. Braun company

DOC373 Rev C 15M 2/17